

به نام خدا



مرکز دانلود رایگان  
مهندسی متالورژی و مواد

[www.Iran-mavad.com](http://www.Iran-mavad.com)



# Handbook of Extractive Metallurgy

Edited by Fathi Habashi

Volume IV: Ferroalloy Metals

Alkali Metals

Alkaline Earth Metals

Authors

Name Index

Subject Index

 WILEY-VCH

Weinheim • Chichester • New York • Toronto • Brisbane • Singapore

Professor Fathi Habashi  
Université Laval  
Département de Mines et de Métallurgie  
Québec G1K 7P4  
Canada

This book was carefully produced. Nevertheless, the editor, the authors and publisher do not warrant the information contained therein to be free of errors. Readers are advised to keep in mind that statements, data, illustrations, procedural details or other items may inadvertently be inaccurate.

Editorial Directors: Karin Sora, Ilse Bedrich  
Production Manager: Peter J. Biel  
Cover Illustration: Michel Meyer/mmada

Library of Congress Card No. applied for  
A CIP catalogue record for this book is available from the British Library

Die Deutsche Bibliothek – CIP-Einheitsaufnahme  
**Handbook of extractive metallurgy** / ed. by Fathi Habashi. –  
Weinheim ; New York ; Chichester ; Brisbane ; Singapore ; Toronto :  
WILEY-VCH ISBN 3-527-28792-2

- Vol. 1. The metal industry, ferrous metals. – 1997  
Vol. 2. Primary metals, secondary metals, light metals. – 1997  
Vol. 3. Precious metals, refractory metals, scattered metals, radioactive metals, rare earth metals. – 1997  
Vol. 4. Ferroalloy metals, alkali metals, alkaline earth metals; Name index; Subject index. – 1997

© VCH Verlagsgesellschaft mbH – A Wiley company,  
D-69451 Weinheim, Federal Republic of Germany, 1997

Printed on acid-free and low-chlorine paper

All rights reserved (including those of translation into other languages). No part of this book may be reproduced in any form – by photoprinting, microfilm, or any other means – nor transmitted or translated into a machine language without written permission from the publishers. Registered names, trademarks, etc. used in this book, even when not specifically marked as such, are not to be considered unprotected by law.

Composition: Jean François Morin, Québec, Canada  
Printing: Strauss Offsetdruck GmbH, D-69509 Mörlenbach  
Bookbinding: Wilhelm Oswald & Co., D-67433 Neustadt/Weinstraße

Printed in the Federal Republic of Germany

## Preface

Extractive metallurgy is that branch of metallurgy that deals with ores as raw material and metals as finished products. It is an ancient art that has been transformed into a modern science as a result of developments in chemistry and chemical engineering. The present volume is a collective work of a number of authors in which metals, their history, properties, extraction technology, and most important inorganic compounds and toxicology are systematically described.

Metals are neither arranged by alphabetical order as in an encyclopedia, nor according to the Periodic Table as in chemistry textbooks. The system used here is according to an economic classification which reflects mainly the uses, the occurrence, and the economic value of metals. First, the ferrous metals, i.e., the production of iron, steel, and ferroalloys are outlined. Then, nonferrous metals are subdivided into primary, secondary, light, precious, refractory, scattered, radioactive, rare earths, ferroalloy metals, the alkali, and the alkaline earth metals.

Although the general tendency today in teaching extractive metallurgy is based on the fundamental aspects rather than on a systematic description of metal extraction processes, it has been found by experience that the two approaches are complementary. The student must have a basic knowledge of metal extraction processes: hydro-, pyro-, and electrometallurgy, and at the same time he must have at his disposal a description of how a particular metal is extracted industrially from different raw materials and know what are its important compounds. It is for this reason, that this *Handbook* has been conceived.

The *Handbook* is the first of its type for extractive metallurgy. Chemical engineers have already had their Perry's *Chemical Engineers' Handbook* for over fifty years, and physical metallurgists have an impressive 18-volume *ASM Metals Handbook*. It is hoped that the

present four volumes will fill the gap for modern extractive metallurgy.

The *Handbook* is an updated collection of more than a hundred entries in *Ullmann's Encyclopedia of Industrial Chemistry* written by over 200 specialists. Some articles were written specifically for the *Handbook*. Some problems are certainly faced when preparing such a vast amount of material. The following may be mentioned:

- Although arsenic, antimony, bismuth, boron, germanium, silicon, selenium, and tellurium are metalloids because they have covalent and not metallic bonds, they are included here because most of them are produced in metallurgical plants, either in the elemental form or as ferroalloys.
- Each chapter contains the articles on the metal in question and its most important inorganic compounds. However, there are certain compounds that are conveniently described together and not under the metals in question for a variety of reasons. These are: the hydrides, carbides, nitrides, cyano compounds, peroxy compounds, nitrates, nitrites, silicates, fluorine compounds, bromides, iodides, sulfites, thiosulfates, dithionites, and phosphates. These are collected together in a special supplement entitled *Special Topics*, under preparation.
- Because of limitation of space, it was not possible to include the alloys of metals in the present work. Another supplement entitled *Alloys* is under preparation.
- Since the largest amount of coke is consumed in iron production as compared to other metals, the articles "Coal" and "Coal Pyrolysis" are included in the chapter dealing with iron.

I am grateful to the editors at VCH Verlagsgesellschaft for their excellent cooperation, in particular Mrs. Karin Sora who followed the project since its conception in 1994, and to

Jean-François Morin at Laval University for his expertise in word processing.

The present work should be useful as a reference work for the practising engineers and the students of metallurgy, chemistry, chemical engineering, geology, mining, and mineral beneficiation. Extractive metallurgy and the chemical industry are closely related; this *Handbook* will

therefore be useful to industrial chemists as well. It can also be useful to engineers and scientists from other disciplines, but it is an essential aid for the extractive metallurgist.

Fathi Habashi

## Table of Contents

|                   |   |                    |                           |
|-------------------|---|--------------------|---------------------------|
|                   |   | <i>Part Seven</i>  | <b>Refractory Metals</b>  |
|                   |   |                    | 26 Tungsten.....1329      |
|                   |   |                    | 27 Molybdenum.....1361    |
|                   |   |                    | 28 Niobium.....1403       |
|                   |   |                    | 29 Tantalum.....1417      |
|                   |   |                    | 30 Zirconium.....1431     |
|                   |   |                    | 31 Hafnium.....1459       |
|                   |   |                    | 32 Vanadium.....1471      |
|                   |   |                    | 33 Rhenium.....1491       |
|                   |   | <i>Part Eight</i>  | <b>Scattered Metals</b>   |
|                   |   |                    | 34 Germanium.....1505     |
|                   |   |                    | 35 Gallium.....1523       |
|                   |   |                    | 36 Indium.....1531        |
|                   |   |                    | 37 Thallium.....1543      |
|                   |   |                    | 38 Selenium.....1557      |
|                   |   |                    | 39 Tellurium.....1571     |
|                   |   | <i>Part Nine</i>   | <b>Radioactive Metals</b> |
|                   |   |                    | 40 General.....1585       |
|                   |   |                    | 41 Uranium.....1599       |
|                   |   |                    | 42 Thorium.....1649       |
|                   |   |                    | 43 Plutonium.....1685     |
|                   |   | <i>Part Ten</i>    | <b>Rare Earth Metals</b>  |
|                   |   |                    | 44 General.....1695       |
|                   |   |                    | 45 Cerium.....1743        |
|                   |   | <i>Volume IV</i>   |                           |
|                   |   | <i>Part Eleven</i> | <b>Ferroalloy Metals</b>  |
|                   |   |                    | 46 Chromium.....1761      |
|                   |   |                    | 47 Manganese.....1813     |
|                   |   |                    | 48 Silicon.....1861       |
|                   |   |                    | 49 Boron.....1985         |
|                   |   | <i>Part Twelve</i> | <b>Alkali Metals</b>      |
|                   |   |                    | 50 Lithium.....2029       |
|                   |   |                    | 51 Sodium.....2053        |
|                   |   |                    | 52 Potassium.....2141     |
|                   |   |                    | 53 Rubidium.....2211      |
|                   |   |                    | 54 Cesium.....2215        |
| <i>Volume I</i>   |   |                    |                           |
| <i>Part One</i>   | <b>The Metal Industry</b>                     |                    |                           |
|                   | 1 The Economic Classification of Metals.....1 |                    |                           |
|                   | 2 Metal Production.....15                     |                    |                           |
|                   | 3 Recycling of Metals.....21                  |                    |                           |
|                   | 4 By-Product Metals.....23                    |                    |                           |
| <i>Part Two</i>   | <b>Ferrous Metals</b>                         |                    |                           |
|                   | 5 Iron.....29                                 |                    |                           |
|                   | 6 Steel.....269                               |                    |                           |
|                   | 7 Ferroalloys.....403                         |                    |                           |
| <i>Volume II</i>  |   |                    |                           |
| <i>Part Three</i> | <b>Primary Metals</b>                         |                    |                           |
|                   | 8 Copper.....491                              |                    |                           |
|                   | 9 Lead.....581                                |                    |                           |
|                   | 10 Zinc.....641                               |                    |                           |
|                   | 11 Tin.....683                                |                    |                           |
|                   | 12 Nickel.....715                             |                    |                           |
| <i>Part Four</i>  | <b>Secondary Metals</b>                       |                    |                           |
|                   | 13 Arsenic.....795                            |                    |                           |
|                   | 14 Antimony.....823                           |                    |                           |
|                   | 15 Bismuth.....845                            |                    |                           |
|                   | 16 Cadmium.....869                            |                    |                           |
|                   | 17 Mercury.....891                            |                    |                           |
|                   | 18 Cobalt.....923                             |                    |                           |
| <i>Part Five</i>  | <b>Light Metals</b>                           |                    |                           |
|                   | 19 Beryllium.....955                          |                    |                           |
|                   | 20 Magnesium.....981                          |                    |                           |
|                   | 21 Aluminum.....1039                          |                    |                           |
|                   | 22 Titanium.....1129                          |                    |                           |
| <i>Volume III</i> |   |                    |                           |
| <i>Part Six</i>   | <b>Precious Metals</b>                        |                    |                           |
|                   | 23 Gold.....1183                              |                    |                           |
|                   | 24 Silver.....1215                            |                    |                           |
|                   | 25 Platinum Group Metals.....1269             |                    |                           |

|                      |                                      |      |
|----------------------|--------------------------------------|------|
|                      | 55 Alkali Sulfur Compounds . . . . . | 2221 |
| <i>Part Thirteen</i> | <b>Alkaline Earth Metals</b>         |      |
|                      | 56 Calcium . . . . .                 | 2249 |
|                      | 57 Strontium . . . . .               | 2329 |
|                      | 58 Barium . . . . .                  | 2337 |
|                      | <b>Authors</b> . . . . .             | 2355 |
|                      | <b>Name Index</b> . . . . .          | 2375 |
|                      | <b>Subject Index</b> . . . . .       | 2379 |

## Part Eleven

### Ferroalloy Metals

|    |    |                 |    |    |    |    |    |    |    |    |    |    |    |    |    |    |    |   |    |
|----|----|-----------------|----|----|----|----|----|----|----|----|----|----|----|----|----|----|----|---|----|
|    |    |                 |    |    |    |    |    |    |    |    |    |    |    |    |    |    |    | H | He |
| Li | Be |                 |    |    |    |    |    |    |    |    |    |    |    |    |    |    |    |   |    |
|    |    |                 |    |    |    |    |    |    |    |    |    |    |    |    |    |    |    |   |    |
| Na | Mg | Al              |    |    |    |    |    |    |    |    |    |    |    |    |    |    |    |   |    |
|    |    |                 |    |    |    |    |    |    |    |    |    |    |    |    |    |    |    |   |    |
| K  | Ca | Sc              | Ti | V  | Cr | Mn | Fe | Co | Ni | Cu | Zn | Ga | Ge | As | Se | Br | Kr |   |    |
| Rb | Sr | Y               | Zr | Nb | Mo | Tc | Ru | Rh | Pd | Ag | Cd | In | Sn | Sb | Te | I  | Xe |   |    |
| Cs | Ba | La <sup>†</sup> | Hf | Ta | W  | Re | Os | Ir | Pt | Au | Hg | Tl | Pb | Bi | Po | At | Rn |   |    |
| Fr | Ra | Ac <sup>‡</sup> |    |    |    |    |    |    |    |    |    |    |    |    |    |    |    |   |    |

|   |    |    |    |    |    |    |    |    |    |    |    |    |    |    |
|---|----|----|----|----|----|----|----|----|----|----|----|----|----|----|
| † | Ce | Pr | Nd | Pm | Sm | Eu | Gd | Tb | Dy | Ho | Er | Tm | Yb | Lu |
|---|----|----|----|----|----|----|----|----|----|----|----|----|----|----|

|   |    |    |   |    |    |    |    |    |    |    |    |    |    |    |
|---|----|----|---|----|----|----|----|----|----|----|----|----|----|----|
| ‡ | Th | Pa | U | Np | Pu | Am | Cm | Bk | Cf | Es | Fm | Md | No | Lr |
|---|----|----|---|----|----|----|----|----|----|----|----|----|----|----|

# 46 Chromium

JAMES H. DOWNING (§§ 46.1–46.7); GERD ANGER † (§ 46.4); PAUL D. DEELEY (§ 46.8); HERBERT KNOPF, PETER SCHMIDT (§§ 46.9.1–46.9.5 EXCEPT 46.9.2.2; 46.9.10); JOST HALSTENBERG (§§ 46.9.1–46.9.6 EXCEPT 46.9.2.2; 46.9.10); MANFRED OHLINGER (§§ 46.9.2.2, 46.9.11, 46.10.3); KLAUS HOCHGESCHWENDER, GEORG UECKER (§§ 46.9.7–46.9.9); ULRICH KORALUS (§ 46.9.11); MANFRED MANSMANN, DIETER RADE, GERHARD TRENCZEK, VOLKER WILHELM (§ 46.10.1); GERHARD ADRIAN, KARL BRANDT (§§ 46.10.2.1–46.10.2.4); GÜNTER ETZRODT (§§ 46.10.2.5, 46.10.4); HELMUT JAKUSCH, EKKEHARD SCHWAB, RONALD J. VEITCH (§ 46.10.3)

|   |      |   |      |
|---|------|---|------|
| 46.1 History  | 1761 | 46.9.4.3 Other Chromates                      | 1790 |
| 46.2 Properties   | 1762 | 46.9.5 Other Chromium Compounds               | 1792 |
| 46.3 Resources and Raw Materials                          | 1762 | 46.9.6 Analysis                               | 1792 |
| 46.4 Ores   | 1763 | 46.9.7 Transportation, Storage, and Handling  | 1793 |
| 46.4.1 Ore Deposits                                       | 1764 | 46.9.8 Environmental Protection               | 1793 |
| 46.4.2 Ore Beneficiation                                  | 1767 | 46.9.9 Ecotoxicology                          | 1794 |
| 46.5 Production   | 1767 | 46.9.10 Economic Aspects                      | 1795 |
| 46.6 Uses   | 1770 | 46.9.11 Toxicology and Occupational Health    | 1795 |
| 46.7 Economic Aspects                                     | 1771 | 46.10 Pigments                                | 1797 |
| 46.8 Alloys   | 1771 | 46.10.1 Chromium Oxide Pigments               | 1797 |
| 46.9 Compounds  | 1772 | 46.10.1.1 Properties                          | 1798 |
| 46.9.1 Sodium Dichromate                                  | 1773 | 46.10.1.2 Production                          | 1798 |
| 46.9.1.1 Alkaline Roasting                                | 1774 | 46.10.1.3 Quality Specifications and Analysis | 1800 |
| 46.9.1.2 Leaching of the Roast                            | 1775 | 46.10.1.4 Storage and Transportation          | 1800 |
| 46.9.1.3 Acidification                                    | 1776 | 46.10.1.5 Uses                                | 1800 |
| 46.9.1.4 Crystallization                                  | 1776 | 46.10.1.6 Economic Aspects                    | 1801 |
| 46.9.2 Chromium Oxides                                    | 1777 | 46.10.1.7 Toxicology and Occupational Health  | 1801 |
| 46.9.2.1 Chromium(III) Oxide and Chromium Hydroxide       | 1777 | 46.10.2 Chromate Pigments                     | 1801 |
| 46.9.2.2 Chromium(IV) Oxide (Chromium Dioxide)            | 1779 | 46.10.2.1 Chrome Yellow                       | 1801 |
| 46.9.2.3 Chromium(VI) Oxide                               | 1780 | 46.10.2.2 Chrome Orange                       | 1803 |
| 46.9.3 Chromium(III) Salts                                | 1782 | 46.10.2.3 Chrome Green and Fast Chrome Green  | 1803 |
| 46.9.3.1 General Properties                               | 1782 | 46.10.2.4 Toxicology and Occupational Health  | 1804 |
| 46.9.3.2 Chromium(III) Sulfates and Chrome Tanning Agents | 1783 | 46.10.2.5 Anticorrosive Chromate Pigments     | 1805 |
| 46.9.3.3 Other Chromium(III) Salts                        | 1785 | 46.10.3 Chromium Dioxide                      | 1806 |
| 46.9.4 Chromic Acids and Chromates(VI)                    | 1787 | 46.10.4 Chromium Phosphate                    | 1807 |
| 46.9.4.1 Chromic Acids                                    | 1787 | 46.11 References                              | 1807 |
| 46.9.4.2 Alkali Chromates and Dichromates                 | 1788 |   |      |

## 46.1 History [1–5]

Chromium was discovered by VAUQUELIN, in the mineral crocoite,  $PbCrO_4$ , in 1797. In 1798 he isolated chromium metal by reducing the oxide with carbon. Soon after the discovery of chromium, the commercial process for manufacturing chromates by roasting chromite with soda ash was developed.

During the 19th century, ferrochromium and chromium were produced by a variety of techniques. However, a commercial process was not developed until 1893, when MOISSAN produced ferrochromium in an electric furnace by the reaction of chromium oxide ( $Cr_2O_3$ ) and carbon. In 1898, GOLDSCHMIDT produced chromium by the aluminothermic reduction of  $Cr_2O_3$ . Other advances have included the application of silicothermics to the

production of low-carbon ferrochromium and chromium, production of chromium by aqueous electrolysis, and production of low-carbon ferrochromium and refining of electrolytic chromium by high-temperature vacuum processing.

Although chromium is found in many minerals, chromite is the only commercial source of chromium. Most of the mineral came from the Ural Mountains up to 1827, when deposits were discovered in the United States. These supplied a limited market up to about 1860, when large deposits were found in Turkey. Since that time chromite has been mined primarily in the eastern hemisphere.

Chromium was electrolyzed from a solution of chromium chloride by BUNSEN in 1854. However, large-scale commercial production of electrolytic chromium did not begin until 1954.

## 46.2 Properties [6–8]

At room temperature chromium is resistant to ordinary corrosive agents, which explains its use as an electroplated, protective coating. It dissolves in nonoxidizing mineral acids, such as hydrochloric and sulfuric acids, but not in cold aqua regia or nitric acid, which passivate the metal. At elevated temperature it reacts with halogens, silicon, boron, nitrogen, oxygen, and carbon.

Chromium and chromium-rich alloys are brittle at room temperature and this has limited their application [9]. Selected physical properties of chromium are as follows:

|  |  |
|--|--|
| $A_r$  | 51.9961                                  |
| Atomic number                                    | 24                                       |
| $m_p$  | 1857 °C                                  |
| $b_p$  | 2672 °C                                  |
| Density $\rho$ at 20 °C                          | 7.19 g/cm <sup>3</sup>                   |
| Crystal structure                                | cubic, body centered                     |
| Specific heat at 25 °C                           | 23.25 Jmol <sup>-1</sup> K <sup>-1</sup> |
| Molar entropy $S_{298}^0$                        | 23.64 Jmol <sup>-1</sup> K <sup>-1</sup> |
| Heat of fusion                                   | 16.93 kJ/mol                             |
| Latent heat of vaporization at $b_p$             | 344.3 kJ/mol                             |
| Linear coefficient of thermal expansion at 20 °C | 6.2 × 10 <sup>6</sup>                    |
| Resistivity at 20 °C                             | 12.9 × 10 <sup>-8</sup> Ωm               |
| Thermal conductivity at 20 °C                    | 67 Wm <sup>-1</sup> K <sup>-1</sup>      |

## 46.3 Resources and Raw

### Materials [4]

Chromite is a spinel FeO·Cr<sub>2</sub>O<sub>3</sub>. In nature it is a mixture described by the formula (Fe<sup>2+</sup>, Mg)O·(Cr, Al, Fe<sup>3+</sup>)<sub>2</sub>O<sub>3</sub>. Chromite ore rarely contains more than 50% Cr<sub>2</sub>O<sub>3</sub>; other minerals such as SiO<sub>2</sub> can also be present.

Chromite is found in stratiform and podiform deposits. Stratiform deposits occur in layers up to a meter thick. The Bushveld Igneous Complex (Transvaal, Republic of South Africa), the Great Dyke (Zimbabwe) and the Stillwater Complex (Montana, United States) are examples. Podiform deposits range in size but a typical commercial deposit will be over 100 000 t. Deposits occur in the Ural Mountains, Albania, Zimbabwe, and the Philippines.

Table 46.1: Chromite production and reserves, 1983 [4].

|                   | Production <sup>a</sup> , 10 <sup>3</sup> t | Reserves <sup>b</sup> , 10 <sup>6</sup> t | Reserve base <sup>b,c</sup> , 10 <sup>6</sup> t |
|-------------------|---|---|---|
| North America     |   |   |   |
| Canada            | 0   | —   | 4   |
| South America     |   |   |   |
| Brazil            | 82  | 8   | 9   |
| Cuba              | 8   | 3   | 3   |
| Europe            |   |   |   |
| Albania           | 277   | 6   | 20  |
| Finland           | 56  | 17  | 29  |
| Greece            | 15  | 1   | 1   |
| Former USSR       | 855   | 129                                       | 129   |
| Africa            |   |   |   |
| Madagascar        | 13  | 7   | 7   |
| Rep. South Africa | 688   | 828                                       | 5715  |
| Sudan             | 8   | 2   | 2   |
| Zimbabwe          | 147   | 17  | 75  |
| Asia              |   |   |   |
| India             | 112   | 14  | 60  |
| Iran              | 16  | 1   | 1   |
| Pakistan          | —   | 1   | 1   |
| Philippines       | 75  | 14  | 29  |
| Turkey            | 103   | 5   | 73  |
| Vietnam           | 5   | 1   | 1   |
| Oceania           |   |   |   |
| New Caledonia     | 30  | 2   | 2   |
| Australia         | —   | —   | 2   |

<sup>a</sup> Estimated.

<sup>b</sup> Shipping grade ore is deposit quantity and grade normalized to 45% Cr<sub>2</sub>O<sub>3</sub> for high-Cr and high-Fe chromite, and 35% Cr<sub>2</sub>O<sub>3</sub> for high-alumina chromite.

<sup>c</sup> Reserve base includes deposits currently economic (reserves), marginally economic, and some currently subeconomic.

The 1983 production and reserves of chromite are shown in Table 1. Generally, richer lumpy Cr bearing ores have been preferred for smelting, whereas those with Cr<sub>2</sub>O<sub>3</sub> content less than 40% have been used in refractories.

## 46.4 Ores [27–39]

The distribution of chromium in terrestrial rocks is closely linked to magmatic intrusions and their crystallization. The average content in the ten-mile crust of the earth is 100 ppm of chromium [33]. Table 46.2 contains a worldwide estimate of chromium ore resources.

The most important applications of chromium ores are in the manufacture of stainless steel, grey cast iron, iron-free high-temperature alloys, and chromium plating for surface protection. In the nonmetallic mineral industry, chromite is processed in conjunction with magnesite (sintered magnesia, calcined magnesia) and binders (clay, lime, gypsum, bauxite, corundum). The products are intended to have good resistance to pressure, fire, and temperature change, as well as good insulating properties between basic and acidic masonry. The chemical industry uses chromium ores in the production of chromium compounds. Table 46.3 shows quality requirements of chromium ores for different areas of application.

Table 46.2: Estimated reserves of chromium ore [93].

|                                       | Reserves, 10 <sup>6</sup> t |   |  |  |
|---------------------------------------|-----------------------------|---|--|--|
|                                       | Total                       | Metallurgical <sup>a</sup> , > 45% Cr <sub>2</sub> O <sub>3</sub> | Chemical <sup>a</sup> , > 40% Cr <sub>2</sub> O <sub>3</sub> | Refractory <sup>a</sup> , > 20% Al <sub>2</sub> O <sub>3</sub> |
| South Africa                          | 2000 <sup>b</sup>           | 100 (5%)  | 1900 (95%)   | —  |
| Zimbabwe                              | 600                         | 300 (50%)   | 300 (50%)  | —  |
| Turkey                                | 10                          | 9 (90%)   | —  | 1 (10%)  |
| Philippines                           | 7.5                         | 1.5 (20%)   | —  | 6 (80%)  |
| United States                         | 8                           | 0.4 (5%)  | 7.4 (92.5%)  | 0.2 (2.5%)   |
| Canada                                | 5                           | —   | 5 (100%)   | —  |
| Finland                               | 7.5                         | —   | 7.5 (100%)   | —  |
| Others                                | 11.35                       | 8.175 (72%)   | 0.2 (2%)   | 2.975 (26%)  |
| <b>Total</b>                          | <b>2649.35</b>              | <b>419.075 (16%)</b>  | <b>2220.1 (84%)</b>  | <b>10.175 (0.4%)</b>   |
| USSR and other Eastern bloc countries | 51.5                        | 26.5 (51%)  | 15 (29%)   | 10 (20%)   |
| <b>Total worldwide (rounded off)</b>  | <b>2701</b>                 | <b>446 (17%)</b>  | <b>2235 (83%)</b>  | <b>20 (1%)</b>   |

<sup>a</sup> Graded according to Cr<sub>2</sub>O<sub>3</sub> or Al<sub>2</sub>O<sub>3</sub> contents.

<sup>b</sup> Ores containing 30–50% Cr<sub>2</sub>O<sub>3</sub>.

**Minerals.** Of the many minerals that contain chromium only the chromium spinels are of economic importance. The formula for the series of isomorphous mixtures of chromium spinels that form geological deposits is

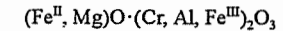

The proportion of Cr<sub>2</sub>O<sub>3</sub> in the chromium spinels varies widely, causing the Cr:Fe ratio (also known as the Cr–Fe factor) to vary as well; this can have a profound effect on the evaluation of a deposit. In an ideal chromium spinel (FeO·Cr<sub>2</sub>O<sub>3</sub>; 67.8% Cr<sub>2</sub>O<sub>3</sub>, 32.2% FeO) the chromium:iron ratio is 2. As a result of the isomorphous inclusion of MgO, the Cr:Fe ratio may rise to between 2.5 and 5. Figure 46.1 shows the region of isomorphism with varying composition of the spinels. Natural chromium spinels usually contain 33–55% Cr<sub>2</sub>O<sub>3</sub>, 0–30% Fe<sub>2</sub>O<sub>3</sub>, 0–30% Al<sub>2</sub>O<sub>3</sub>, 6–18% FeO, and 10–32% MgO. Table 46.4 lists some physical properties of chromium spinels.

Chromium also occurs in all groups of silicates where chromium replaces Al<sup>3+</sup>, Fe<sup>3+</sup>, and Mg<sup>2+</sup>. Sulfidic chromium ores do not occur on earth. Chromates and chromium iodates are described, which originate from the weathering zone of sulfidic lead deposits (e.g., crocoite, PbCrO<sub>4</sub>).

**Table 46.3:** Quality requirements (mass fractions in %) for chromium ores (according to U.S. Bureau of Mines).

|   | Metallurgical (high-Cr chromite) | Refractory (high-Al chromite) | Chemical (high-Fe chromite) |
|---|----------------------------------|-------------------------------|-----------------------------|
| Cr:Fe ratio   | 3:1 or higher                    | —                             | —                           |
| Cr <sub>2</sub> O <sub>3</sub>                                  | > 48                             | > 31                          | > 44                        |
| Cr <sub>2</sub> O <sub>3</sub> + Al <sub>2</sub> O <sub>3</sub> | —                                | > 58                          | —                           |
| Fe  | —                                | < 12                          | —                           |
| SiO <sub>2</sub>  | < 8                              | < 6                           | < 5                         |
| S   | < 0.08                           | —                             | —                           |
| P   | < 0.04                           | —                             | —                           |
| CaO   | —                                | < 1                           | —                           |

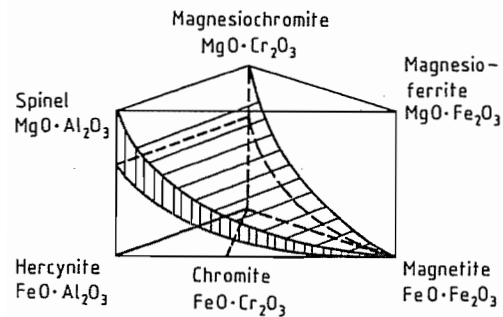
**Figure 46.1:** Ternary spinel system showing main isomorphous region.**Table 46.4:** Physical properties of chromium spinels.

| Properties   | Notes  |
|--|--|
| Specific density: 3.8–4.8                              | increases as Fe and Cr contents increase   |
| Mohs Hardness: 4.5–8                                   | increases with increase in the ferrochromite component, very high for Al spinels |
| Melting point: 1545–1730 °C                            | inclusion of Mg raises melting point, inclusion of Fe <sup>2+</sup> reduces it   |
| Color: dark brown to black                             | reddish with high Cr <sub>2</sub> O <sub>3</sub> content                         |
| Streak on porcelain plate; hammer striking mark: brown | important feature for differentiating from serpentine                            |

#### 46.4.1 Ore Deposits

Chromium ore deposits can be divided into two genetically different types:

- Seam-like deposits, also called stratiform or anorogenic deposits. Main representatives are Bushveld, Great Dyke, and Stillwater.
- Deposits which are shaped like sacks or tubes; they are called podiform or orogenic

deposits. Main representatives are Selukwe, Guleman, and Tiebaghi.

Various intermediate types such as adjacent “seam” pockets, striated chromite slabs, mottled ores, and vein-like deposits also occur. “Placer” deposits, i.e., enrichment due to chromite lumps and grains on or near primary deposits, are now achieving economic importance.

The seam-like deposits reveal layers or strata of chromite enrichment, with thicknesses ranging from centimeters to decimeters; the layers are regularly interlaminated with banded series of olivine-rich or pyroxene-rich rocks. The Main Seam of the Western Bushveld is, for example, 1.10–1.30 m thick and can be traced for over 65 km without any significant change in the mineral composition or thickness.

The demarcation between the chromite enrichment and the underlying bed is usually razor-sharp; in the direction of the overlying layer, disintegration into layers or mottled ores as a result of increased silicate content is observed.

The chromite bodies that are sack-like to tube-like in appearance are usually aligned with the direction of the magmatic stratification, i.e., the lowest sections are massive chromite ores; in the direction of the overlying layer, these merge into striated slabs or mottled ores.

The internal texture of the chromite ore bodies varies widely. The closest chromite crystal packing results in the formation of massive ores containing 75–85 vol% of chromite. Sphere or leopard ores, which consist of round chromite crystal aggregates 0.5–2 cm in diameter in a silicate matrix (olivine, pyroxene, serpentine), are also characteristic. Banded ores are closely related to the massive ores, but they are frequently richer in silicate and then form a link with the mottled ores (chromite single crystals in silicate matrix).

During transformation (serpentinization), the silicate content within the chromite ore bodies has resulted in the formation of friable and pulverizable masses (friable ore) which are encountered not only near the surface but

also at depths of several hundred meters below the present-day land surface.

Chromite transformation in the course of more recent tectonic superficial modification under pneumatolytic or hydrothermal conditions has resulted in the striking colors of recent uvarovite, smaragdite, and kammererite formations which act as pathfinders in prospecting and exploring for chromite deposits. Table 46.5 shows some analyses of selected chromium ores.

**Former Soviet Union.** The former Soviet Union is one of the most important producers of chromium ore in the world. All the deposits are distributed in ultrabasite massifs in the Central and Southern Urals.

The deposits that are most important at present were found in the late 1930s in the Akhtyubinsk region (North Kazakhstan). The Donskoye deposit, which is associated with the mining settlement of Khrom Tau, contains high-grade chromium ores for ferrochromium production and low-grade ores for chemical purposes. Mining is carried on in numerous open-pit mines, which implies that the ore

bodies are small. A new open-cast mine was put into production near Donskoye, as is a processing plant with a throughput of 10<sup>6</sup> t/a. Strong prospection effort for new occurrences is being made in the Northern Urals, but because of the rough climate no mine has been opened up to 1986.

**Bushveld.** In the Bushveld (South Africa) mining began in the 1920s in two districts: the Lydenburg district (Eastern Bushveld) and the Rustenburg district (Western Bushveld).

From a geological and petrological point of view this is a large intrusion of 500 × 250 km with a thickness of over 5 km. The chromite “seams” are located in the pyroxenite-norite zone of the basal section of the intrusion, always below the platinum-bearing Merensky Reef. In the case of Rustenburg there are up to 25 chromite seams on top of each other. The thickness of the individual seams varies from a few centimeters to 1.80 m. The seams are workable from 0.35 m upward, especially if they can be combined into mining units (Cr<sub>2</sub>O<sub>3</sub> content in the crude ore 30–40%; Cr:Fe ratio = 1.6–2.3).

**Table 46.5:** Chemical analyses (mass fractions in %) of some chromium ores (crude ores, concentrates).

| Country                     | Cr <sub>2</sub> O <sub>3</sub> | FeO  | SiO <sub>2</sub> | MgO  | Al <sub>2</sub> O <sub>3</sub> | CaO               | V <sub>2</sub> O <sub>5</sub> | Cr:Fe ratio |
|-----------------------------|--------------------------------|------|------------------|------|--------------------------------|-------------------|-------------------------------|-------------|
| South Africa                |                                |      |                  |      |                                | n.d. <sup>b</sup> |                               |             |
| Rustenburg (c) <sup>a</sup> | 44.5                           | 26.4 | 3.5              | 10.6 | 14.1                           | 0.4               |                               | 1.7:1       |
| Lydenburg (c)               | 44.3                           | 24.6 | 2.3              | 11.2 | 16.1                           |                   |                               | 1.8:1       |
| Zimbabwe                    |                                |      |                  |      |                                |                   |                               |             |
| Great Dyke (m)              | 48.5                           | 18.3 | 5.6              | 13.4 | 11.5                           | 0.8               |                               | 2.6:1       |
| Great Dyke (r)              | 50.7                           | 16.4 | 4.3              | 13.2 | 13.0                           | 0.8               |                               | 3.1:1       |
| Selukwe (m)                 | 47.0                           | 12.0 | 5.7              | 15.5 | 12.6                           | 1.8               |                               | 3.9:1       |
| Selukwe (r)                 | 42.0                           | 15.7 | 8.6              | 15.8 | 13.8                           | 0.3               |                               | 2.7:1       |
| Turkey                      |                                |      |                  |      |                                |                   |                               |             |
| (m)                         | 48.3                           | 14.1 | 5.1              | 16.8 | 13.0                           | 0.9               |                               | 3.4:1       |
| (r)                         | 37.0                           | 15.2 | 4.3              | 17.7 | 24.3                           | 0.2               |                               | 2.4:1       |
| Philippines                 |                                |      |                  |      |                                |                   |                               |             |
| (Masinloc) (r)              | 33.3                           | 13.2 | 4.6              | 19.6 | 28.2                           | 0.4               |                               | 2.5:1       |
| Finland (Kemi)              |                                |      |                  |      |                                |                   |                               |             |
| Crude ore                   | 26.5                           | 15.0 | 18.5             | 19.5 | 9.5                            | n.d.              | 0.04–0.1                      | 1.8:1       |
| Concentrate                 | 45.7                           | 33.8 | 0.4              | 2.9  | 13.6                           |                   | 0.1                           | 1.4:1       |
| Albania                     |                                |      |                  |      |                                |                   |                               |             |
| (m, r)                      | 43.0                           | 16.2 | 9.8              | 22.2 | 7.9                            | 0.1               |                               | 2.6:1       |
| USSR                        |                                |      |                  |      |                                |                   |                               |             |
| (m)                         | 53.9                           | 12.6 | 5.8              | 13.3 | 9.6                            | 1.1               |                               | 4.3:1       |
| (r)                         | 39.1                           | 14.0 | 9.4              | 16.1 | 17.4                           | 0.7               |                               | 2.8:1       |

<sup>a</sup>(m) = metallurgical, (r) = refractory, (c) = chemical.  
<sup>b</sup>n.d. = not determined.



In the Lydenburg district, which is genetically very similar to the Rustenburg district, only two seams are being mined; the  $\text{Cr}_2\text{O}_3$  content is 44% and the chromium: iron ratio 1.6–1.7. The iron content is frequently high, which may cause difficulties in the case of metallurgical ores; however, these ores are highly valued as chemical ores.

**Great Dyke.** The Great Dyke (Zimbabwe) is an intrusion which is 610 km long and 6–9 km thick — a remarkable length: thickness ratio which is unique in the world. The internal structure is similar to that of the Bushveld. From north to south, the individual complexes are Musengezi, Hartley, Selukwe, and Wedza. Selukwe consists of sack-like deposits containing 48%  $\text{Cr}_2\text{O}_3$  and even more, with a chromium: iron ratio greater than 2.8 (a highly valued metallurgical ore). In the Hartley region, on the other hand, numerous bands and seams 2–75 cm thick are being mined; these are separated by serpentized peridotite layers, some of which are very thick and make mining very difficult. However, the  $\text{Cr}_2\text{O}_3$  content varies between 48 and 57%, and the chromium: iron ratio is over 2.8 (Table 46.6).

According to conservative estimates, 1 km<sup>2</sup> of the Great Dyke contains around  $1.4 \times 10^6$  t of crude ore, which corresponds to assured reserves of  $600 \times 10^6$  t (geologically  $4.6 \times 10^9$  t are possible).

Table 46.6: Analysis of chromium ores from Zimbabwe.

|               | $\text{Cr}_2\text{O}_3$ content, % | Cr:Fe ratio | Proportion, % |
|---------------|------------------------------------|-------------|---------------|
| Metallurgical | over 48                            | over 2.8    | 80            |
| Chemical      | 45–48                              | 2.2–2.5     | 17            |
| Refractory    | 42–46                              | 1.8–2.0     | 3             |

**Madagascar.** On the island of Madagascar, chromium ores are being mined since 1967 with an annual production of around 60 000 t of metallurgical grade ore. Total output is calculated to be almost  $2 \times 10^6$  t since the beginning of the operation (50–52%  $\text{Cr}_2\text{O}_3$ ). The reserves are said to be around  $5.5 \times 10^6$  t.

**Turkey.** Turkey still is the traditional country for chromite deposits of metallurgical quality, but because of falling prices on the world market and exhaustion of reserves, many mines

have been forced to close. The most important regions belong essentially to the alpidic era, e.g., Bursa, Mugla district, and Elazig, including the Guleman chrome ore field. Open-pit mining, and in some places underground mining at shallow depths, are employed.

**Iran.** Chromite deposits are described in two regions of Iran: northwest of Sabzawar near Mashad and 200 km northeast of the Gulf port of Bandar Abbas. These deposits are pocket-like, sometimes containing only 500 t of ore. Extraction is by open-pit mining and by primitive underground mining. Only hard lump ore for metallurgical applications is sometimes exported.

**Philippines.** On the Philippine island of Luzon the most important chromite deposits are to be found in the Coto region (near Masinloc, province of Zambales). These are chromite seams and pockets within layered dunites and harzburgites. They are classical metallurgical and refractory ores. More recently a new type of chrome ore has been put into production: chromite from lateritic soils. The concentrates are suited for the chemical industry.

**Finland.** In 1959 a fairly large deposit of chromite was discovered near Kemi, which has been developed into a productive mine. Chromium ore occurs in a serpentinite-anorthosite massif 12 km long and 1–2 km wide; the ore zone, however, is only 15 100 m thick and dips at an angle of 60° toward the north. The  $\text{Cr}_2\text{O}_3$  content of the crude ore of the various ore bodies varies between 17.5 and 21.9% (locally even up to 30.5%  $\text{Cr}_2\text{O}_3$ ); the chromium: iron ratio is low (0.81–1.87).

**Yugoslavia.** The deposits of chromite in Yugoslavia are restricted to the Raduša massif near Skopje, but the mining of metallurgical ores there has fallen considerably. Native ores are being processed in a new plant, whereas ores imported from Albania are being processed in the old one. The chromium ores are always associated with serpentized ultrabasic rocks. The striated slab type predominates, but massive chrome ores are encountered in some places.

**Albania.** Since 1960, Albania has become the third largest producer in the world. All actual data are based on estimates because the Albanian government withholds production and export figures. Albanian deposits belong to the podiform type and normal grades are reported to be 43%  $\text{Cr}_2\text{O}_3$  with a Cr:Fe ratio of 3:1. The largest chrome ore mines are Bulquize and Matanesh with concentration plants of 300 000 t/a each.

#### 46.4.2 Ore Beneficiation

The simplest method of concentrating chromite is by hand picking; this is still employed today at many pits, including those in Turkey, Brazil, Iran, and the Philippines. Because the mining of richer ores continues to decline, concentrating procedures, chiefly using the gravity method, have been developed to separate the serpentine from the chromite. For example, in South Africa or Brazil the chromite ores are enriched by crushing, milling, screening, and sophisticated gravity procedures. In South Africa, spirals and diamond pans are standard equipment. A combination of Reichert cones and Reichert spirals has also been employed. Although the costs are higher, the use of hydrocyclones for separating the fine chromite grains from waste is of great importance in the recycling of tailing dumps. Some chromium ores contain magnetite which can be removed by means of magnetic separation. However, if the magnetite is present as an individual phase within the chromite grains or as a fringe around the grains, this method is only suitable if  $\text{Cr}_2\text{O}_3$  is further enriched. Flotation and electrostatic processes have so far enjoyed little success in the concentration of chromium ores. If the  $\text{Cr}_2\text{O}_3$  content or the chromium: iron ratio is sufficient, fine-grained chromite concentrates can be briquetted or pelleted with the aid of binders.

The yield (65–85% of the chromite actually contained in the crude ore) depends on many factors including the nature of the chromite-serpentine intergrowth, grain size, and  $\text{Cr}_2\text{O}_3$  content of the ore or individual grain.

At the chromite concentration plant at Kemi in Finland a fraction of the crude ore (70%) is crushed to below 10 mm in a primary crusher plant at the open-pit mine. After further grinding (rod and ball mill) and removal of sludge, the intermediate product is dried in a rotary kiln. The magnetic separation (a combination of weak and strong fields) produces two concentrates: concentrate 1 containing 45.9%  $\text{Cr}_2\text{O}_3$ , which is sold or used as molding sand, and concentrate 2 containing 42.0%  $\text{Cr}_2\text{O}_3$  for the production of ferrochromium.

#### 46.5 Production<sup>1</sup>

**Extraction.** Chromium is extracted from its ores by alkaline or acidic dissolution. In alkali dissolution, finely ground chrome ore is roasted with  $\text{Na}_2\text{CO}_3$  under oxidizing conditions at ca. 1100 °C. The sodium chromate is leached from the calcine; most of the gangue is insoluble. The solution containing hexavalent chromium can be reduced with  $\text{SO}_2$  and used for electrowinning, or  $\text{Na}_2\text{Cr}_2\text{O}_7$  can be crystallized from it. The  $\text{Na}_2\text{Cr}_2\text{O}_7$  can be converted to  $\text{CrO}_3$  for use in electrolysis or to  $\text{Cr}_2\text{O}_3$  for use in metallothermics.

Chrome ore can be dissolved in acid if an oxidizing agent is present. However, Fe, Al, and Mg also dissolve and must be removed. The preferred acidic dissolution technique is to reduce the ore with carbon, forming ferrochromium, which is ground and dissolved in sulfuric acid. The only significant impurity carried over is Fe, which is removed by crystallization as iron(II) ammonium sulfate. The chromium in the solution is in the +3 valence state and with additional purification is used to produce electrolytic chromium.

**Production of Chromium Metal.** Chromium metal is produced by the reduction of  $\text{Cr}_2\text{O}_3$  or the electrolysis of Cr(III) solutions. The metal can also be obtained from Cr(VI) solutions by electrolysis, but the process is less efficient and is used primarily for plating.

<sup>1</sup> For Ferrochromium, see Section 7.5.

**Aluminothermic Reduction.** Aluminum is the most important reducing agent for producing chromium from  $\text{Cr}_2\text{O}_3$ . Closely sized high-purity Al powder and  $\text{Cr}_2\text{O}_3$  are blended and charged into a vessel lined with refractory, which is usually  $\text{Al}_2\text{O}_3$ . The charge is ignited either with a  $\text{KClO}_4$ -Al powder "wick" or electrically. The exothermic reaction results in a temperature greater than  $2000^\circ\text{C}$ , which leads to a clean separation of slag from metal. The purity of the chromium metal depends on the purity of the reactants, particularly the  $\text{Cr}_2\text{O}_3$ . Originally this oxide was made by reduction of sodium chromate with sulfur, resulting in  $\text{Cr}_2\text{O}_3$  of high sulfur content. Proprietary processes have been developed to produce  $\text{Cr}_2\text{O}_3$  of higher purity. Analysis of aluminothermically reduced chromium is given in Table 46.7.

Chromium is also produced by *carbon reduction*. Chromium oxide and carbon are carefully weighed, mixed, briquetted, and heated in a furnace at  $1400^\circ\text{C}$  at a minimum pressure of 40 Pa. The heating cycle is 100 h. The C + O content is  $\leq 1.5\%$  (Table 46.7).

Solutions suitable for *electrolytic production* of chromium can be derived from ore by oxidative roasting in alkali, or by direct solution of chromite in sulfuric acid; however, a commercial process was not achieved until the electrolyte was made by dissolving ferrochromium in  $\text{H}_2\text{SO}_4$  and reduced anolyte. Figure 46.2 [10] shows the essential aspects of the process for electrolytic production of chromium metal.

Milled FeCr is leached with hot reduced recycled anolyte, chrome alum mother liquor, and makeup  $\text{H}_2\text{SO}_4$ . The iron precipitates on cooling as iron(II) ammonium sulfate

$[\text{Fe}(\text{NH}_4)_2(\text{SO}_4)_2]$ , which is recrystallized to recover the coprecipitated chromium.

The chromium is further purified by precipitation of chrome alum. Transformation of the Cr(III) to an insoluble salt requires aging at  $30^\circ\text{C}$ . After filtration the mother liquor is recirculated to the leach tank. The chrome alum crystals are redissolved to make the cathode feed. The overflow anolyte contains Cr(VI), which is reduced by  $\text{SO}_2$ , thereby generating additional  $\text{H}_2\text{SO}_4$ . The reduced anolyte is also cycled to the leach tank. The stripped catholyte is recycled. Dissolved chrome alum crystals are used to bring the chromium concentration in the catholyte feed up to the desired level.

The details of the cell reactions are shown in Figure 46.3 [11]. A diaphragm is necessary to prevent migration of Cr(VI) into the cathode compartment where its reduction by Cr(II) would lead to loss of current efficiency. Flow is maintained into the anode compartment from the cathode compartment by a higher level of solution in the latter. The pH of the catholyte must be controlled. At too low a value,  $\text{H}_2$  evolution increases; at too high a value, precipitation of  $\text{Cr}(\text{OH})_3$  occurs. This can be seen by an examination of the pH-potential diagram [12]. The pH is controlled by chromium concentration, current density, temperature, and differential height of solution between cathode and anode compartments. Water is fed to the anode to control the concentration of  $\text{H}_2\text{SO}_4$ .

Chromium is plated onto stainless steel cathodes until it attains a thickness of ca. 3 mm. The plate is stripped from the cathode and degassed by heating at  $420^\circ\text{C}$ . The analysis of the flake is shown in Table 46.7.

Table 46.7: Analysis of various grades of chromium metal (in %).

|                             | Cr   | C                | O    | Si   | S     | P     | N     | Al     |
|-----------------------------|------|------------------|------|------|-------|-------|-------|--------|
| Aluminothermic <sup>a</sup> | 99.4 | 0.05             | 0.10 | 0.10 | 0.010 | 0.010 | 0.02  | 0.10   |
| Electrolytic <sup>b</sup>   | 99.1 | 0.02             | 0.5  | 0.01 | 0.03  | 0.01  | 0.05  | 0.01   |
| Electrolytic <sup>b,c</sup> | 99.5 | 0.05             | 0.02 | 0.05 | 0.04  | 0.01  | 0.002 | 0.0158 |
| Carbon reduced <sup>b</sup> | 98   | 1.5 <sup>d</sup> | —    | —    | 0.1   | 0.02  | 0.001 | 0.1    |

<sup>a</sup> Shieldalloy Corp.

<sup>b</sup> Elkem Metals Co.

<sup>c</sup> Vacuum treated.

<sup>d</sup> C + O.

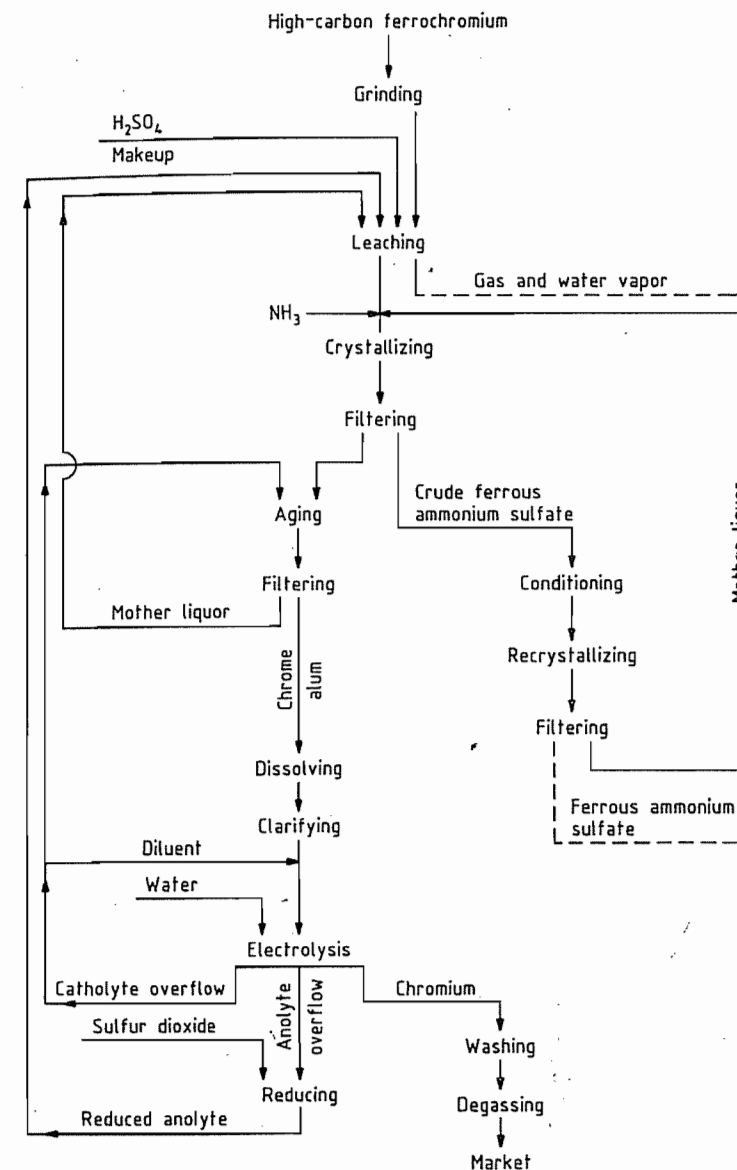

Figure 46.2: Flow sheet for producing electrolytic chromium from ferrochromium [10].

For many applications the oxygen content of the electrolytic chromium is too high. Deoxidation is carried out on a commercial scale by two techniques [13]. In the first either flake or briquettes of powdered flake are contacted with  $\text{H}_2$  at elevated temperature. The procedure is less effective on chromium pro-

duced from chrome alum solutions than on chromium from hexavalent solutions [14]. The second technique involves heating briquettes of ground electrolytic flake and carefully controlled trace amounts of C in a vacuum furnace to form CO. The heating cycle is 90 h, the maximum temperature is

1400 °C, and the pressure is 13 Pa. The product is cooled in helium to prevent contamination. Analysis of the vacuum-treated product is shown in Table 46.7.

There are several other techniques for purifying chromium. These include iodide refining [9, 14], zone melting [9, 14], and treating chromium with a flux containing an alkaline earth metal [15]. Chromium prepared by these methods is purer but more expensive, and therefore is used only in, electronic applications.

## 46.6 Uses [4]

Chromium is used in ferrous and nonferrous alloys, in refractories, and in chemicals.

Chromium enhances an alloy's hardenability, creep and impact strength, and resistance to corrosion, oxidation, and wear. Ferrous alloys, mainly stainless steels, account for most of the consumption. These steels have a wide range of mechanical properties as well as being corrosion and oxidation resistant. Cast irons may contain from 0.5% to 30% Cr, which provides hardenability, toughness, hardness, and corrosion and wear resistance. Chromium is widely used in nonferrous alloys, including those based on nickel, iron-nickel, cobalt, aluminum, titanium, and copper. In Ni, FeNi, and Co, Cr is used for oxidation and corrosion resistance. In Al, Ti, and Cu it controls the microstructure.

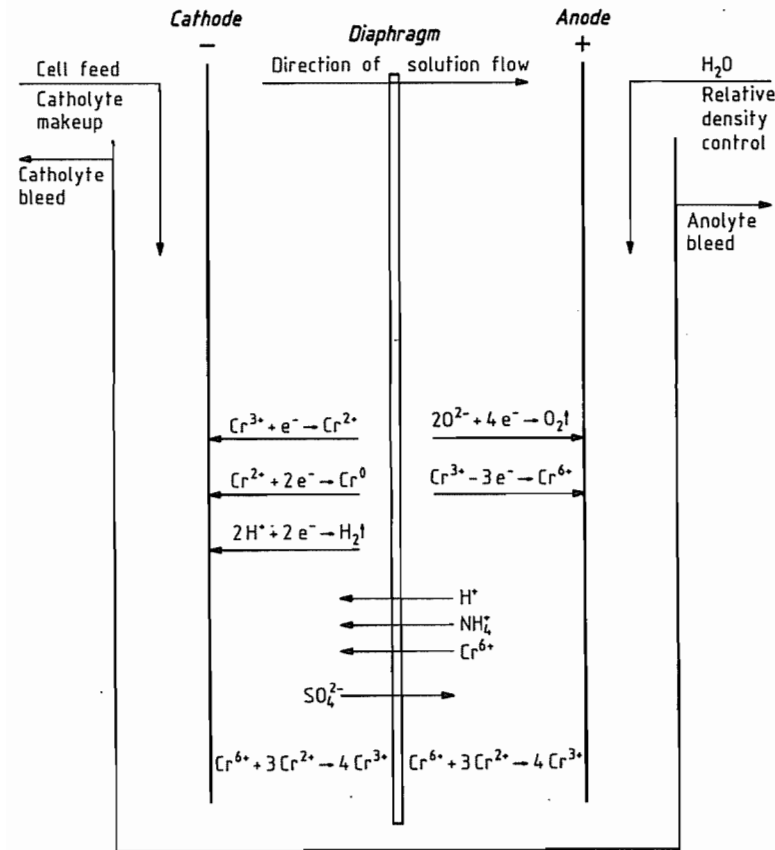

Figure 46.3: Idealized electrolytic cell reactions.

Chromium chemicals are used in a variety of applications. The largest amount is consumed to manufacture pigments for use in paints and inks. Other applications include leather tanning, metal corrosion inhibition, drilling muds, textile dyes, catalysts, and wood and water treatment.

Chromite is used in the refractory industry to make bricks, mortar, and ramming and gunning mixes. Chromite enhances thermal shock and slag resistance, volume stability, and strength.

## 46.7 Economic Aspects

The world production of chromium fluctuated between 1973 and 1983; however, growth is expected to the end of the century. Data for worldwide production are as follows [4]:

| Year | Production, 10 <sup>3</sup> t | Year | Production, 10 <sup>3</sup> t |
|------|-------------------------------|------|-------------------------------|
| 1973 | 1999                          | 1979 | 2936                          |
| 1974 | 2207                          | 1980 | 2973                          |
| 1975 | 2540                          | 1981 | 2786                          |
| 1976 | 2669                          | 1982 | 2489                          |
| 1977 | 2883                          | 1983 | 2490                          |
| 1978 | 2820                          | 2000 | 5625 <sup>a</sup>             |

<sup>a</sup>Probable projected demand.

## 46.8 Alloys

In the manufacture of steel, chromium is added usually in the form of ferrochrome. Pure chromium metal, produced by electrolytic or aluminothermic processes, is used for alloying nonferrous engineering materials. The most common materials are nickel-based and cobalt-based alloys, most of which are used at high temperature.

The only true chromium-based alloys that have been developed and used commercially are a few chromium-nickel alloys developed by the International Nickel Co. (INCO). These materials contain 50–60% chromium; the remaining percentage is nickel, with either niobium (columbium) or titanium specified as carbon and nitrogen scavengers. These alloys, as well as materials cited in [16, 17], often referred to as superalloys, are used in construct-

ing high-temperature exposed components in chemical and petrochemical industries.

Chromium-based alloys have found a unique application in power stations as supports for heat exchanger pipes. The balance of cobalt- and nickel-based high-chromium alloys are used mainly in components for gas turbine engines and for parts requiring resistance to elevated temperature, oxidation, and hot corrosion.

Chromium metal in powder form is used in the manufacture of *cermets* [18]. The cermets of commercial importance are as follows:

Cermet LT-1: 77% Cr, 23% Al<sub>2</sub>O<sub>3</sub>  
 Cermet LT-1B: 59% Cr, 19% Al<sub>2</sub>O<sub>3</sub>, 20% Mo, 2% TiO<sub>2</sub>  
 Cermet LT-2: 25% Cr, 15% Al<sub>2</sub>O<sub>3</sub>, 6% W

These particular cermets have very good thermal stability and corrosion resistance.

Chromium metal from electrolytic or aluminothermic processes is used in a briquetted aluminum powder compact to provide the alloying addition to both cast and wrought aluminum products [19]. Two grades of smelted binary aluminothermic chromium-aluminum alloys (10% chromium and 20% chromium) are also used.

Other binary aluminothermic chromium alloys available for special alloying requirements are chromium-molybdenum (30% Mo) and niobium-chromium (30% Nb). Chromium-tungsten binary alloys were once used but are now redundant [20, 21].

Metallic chromium powders are used in both coated and cored welding electrodes. Small quantities of pure chromium are used for anodes in X-ray tubes and also for vacuum vaporization or sputtering.

Chromium powder, as well as ferrochromium powder, has been used in considerable quantities to produce *chromium coatings*.

The so-called pack chrome coating [21, 22] is applied to cast and wrought steel parts by immersing the article in a mixture of chromium powder, an inert material, e.g., kaolin, alumina, or magnesia; and mixtures of various salts, such as ammonium, iodide, or chloride. The packed part is then heated in an inert atmosphere at 900–1300 °C (heating time is dependent on part size).

Table 46.8: Uses of chromium compounds.

| Branch of industry    | Product  | Use   |
|-----------------------|--|---|
| Building industry     | chromium(III) oxide                                      | pigment for coloring building materials   |
| Chemical industry     | dichromates, chromium(VI) oxide                          | oxidation of organic compounds, bleaching of montan waxes, manufacture of chromium complex dyes |
| Printing industry     | chromium(III) oxide                                      | catalysts   |
|                       | dichromates  | photomechanical reproduction processes  |
|                       | chromium(VI) oxide                                       | chromium plating of printing cylinders  |
| Petroleum industry    | chromates(VI)  | corrosion protection  |
| Paints and lacquers   | chromates, chromium(III) oxide                           | pigments  |
| Refractory industry   | chromium(III) oxide                                      | additive for increasing slag resistance   |
| Electroplating        | chromium(VI) oxide                                       | bright and hard chromium plating  |
| Wood industry         | chromates, chromium(VI) oxide                            | in mixtures of salts for protecting wood against fungi and insects                              |
| Leather industry      | basic chromium(III) sulfates                             | tanning of smoothed skins   |
| Metal industry        | chromium boride, chromium carbide                        | flame sprays  |
|                       | chromium(III) oxide                                      | polishing agents  |
| Metallurgy            | chromium(III) oxide                                      | aluminothermic extraction of pure chromium metal  |
| Textile industry      | dichromates  | dyeing with chrome dyes   |
|                       | basic chromium(III) acetates and chromium(III) fluorides | mordanting of textiles  |
| Recording industry    | chromium(VI) oxide                                       | magnetic information storage  |
| Pyrotechnics industry | dichromates  | additive to igniting mixtures   |

Another procedure is the so-called gas chromium coating [22]. Steel parts and the chrome coating mixture are placed in a vessel at 1050–1250 °C. Volatile chrome compounds react with the steel components. The coating mixture consists mostly of chromium powder (both chromium metal and ferrochromium have been used [23]); inert materials (similar to those used in the pack chromium coating); and a relatively high concentration of a salt (fluoride, ammonia, or cryolite).

The gas chromium coating has been used to produce a so-called tin-free steel and to treat sheet steel on a continuous line.

Although chrome plating is used to produce a shiny as well as a hard satin finish, the source is from chromium salts rather than from aluminothermic or electrolytic chromium.

## 46.9 Compounds

Chrome iron ore (chromite) was discovered in 1798. A few decades later this ore was being subjected to oxidative roasting in the presence of soda and lime in manually operated furnaces to produce water-soluble sodium dichromate. This was processed further to yield yellow, red, and green chromium pig-

ments which were used among other things, for dyeing wallpaper; they replaced the toxic arsenic dyes that had been used until then. Chromium salts soon found their way into the textile industry as mordants for the dyeing of wool.

The importance of dichromates increased considerably in the period following 1870 when the rising coal tar dye industry needed large quantities for the oxidation of chemical intermediates. With the advent of the 20th century, chrome tanning was introduced in leather factories and in many areas replaced vegetable tanning.

The manufacture of chromium compounds received a further boost after 1930, when metallic chromium was successfully precipitated from chromic acid solutions by special additives. Since then this possibility has been used extensively in electroplating for bright and hard chromium plating.

Chromium compounds are used in numerous fields. In addition to the applications mentioned, chromates have long been used in printing as an aid in photomechanical reproduction. For some time, chromium dioxide has been a component of magnetic tapes for information storage. Table 46.8 lists important applications of chromium chemicals.

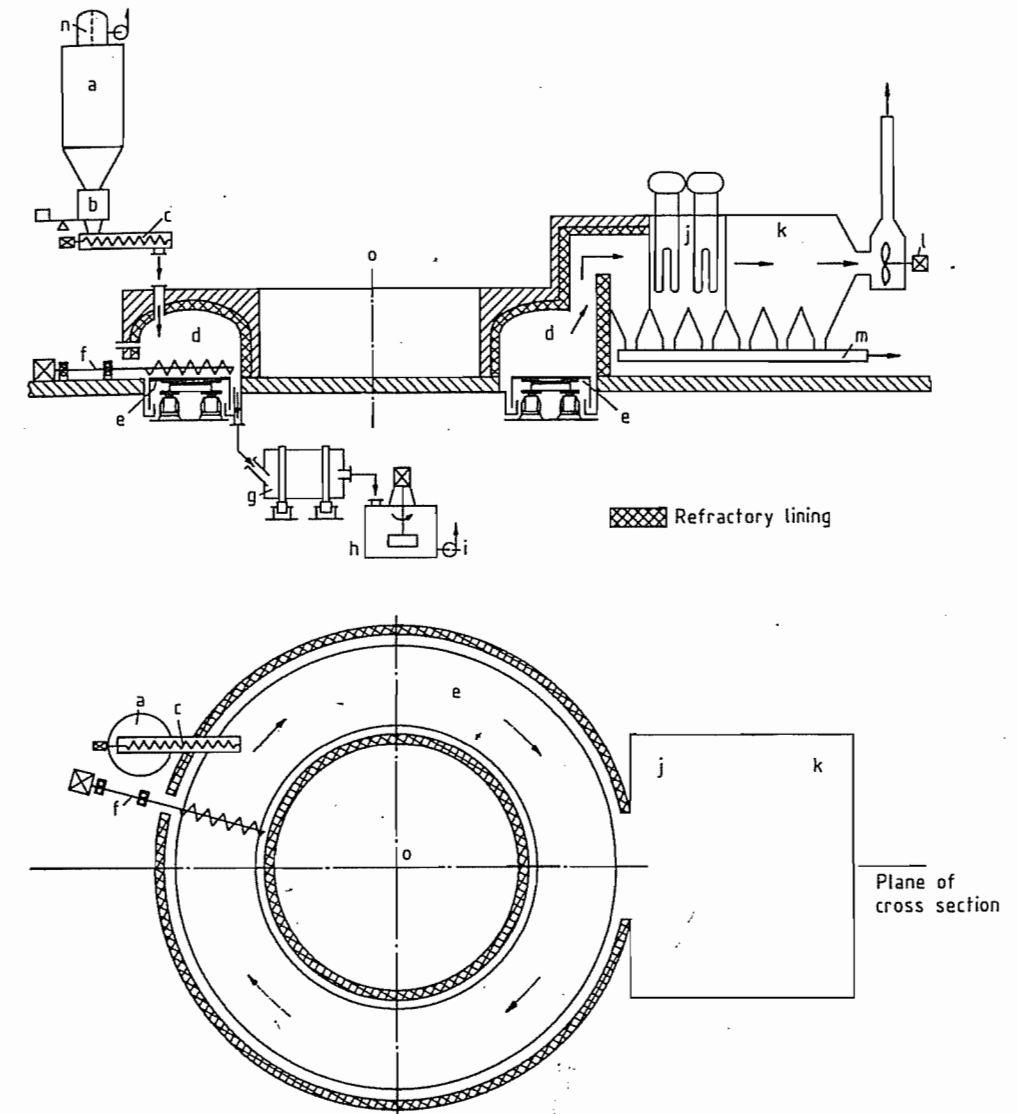
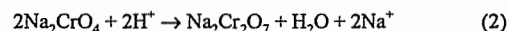
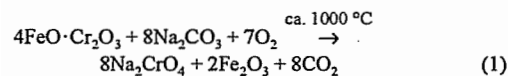

Figure 46.4: Annular hearth furnace: a) Mixture silo; b) Scales; c) Feed screw; d) Furnace; e) Annular hearth; f) Water-cooled ribbon screw; g) Wet tube mill; h) Stirred vessel; i) Pump for filtering system; j) Waste heat boiler; k) Electrostatic gas purification; l) Exhaust gas fan; m) Dust drag chain; n) Bin filter; o) Rotation axis.

### 46.9.1 Sodium Dichromate

Directly or via several intermediate stages, sodium dichromate,  $\text{Na}_2\text{Cr}_2\text{O}_7 \cdot 2\text{H}_2\text{O}$ , is the starting material for the production of all chromium compounds and pure chromium metal. Sodium dichromate is made in a three-step

process: (1) alkaline roast of chromite under oxidizing conditions (Equation 1), (2) leaching, and (3) conversion of sodium monochromate to sodium dichromate by means of an acid (Equation 2).



#### 46.9.1.1 Alkaline Roasting

Soda ash (sodium carbonate) is generally used as the alkali component but sodium hydroxide may also be employed [40–42]. The degree of solubilization of chromites by the roasting process depends on their composition. For optimum results, the process is controlled by adding so-called carrier materials. These ensure sufficient porosity of the material so that oxygen can diffuse into the roast. Porosity is maintained by means of such materials as iron oxide, bauxite, or dried leach residue;  $\text{CO}_2$ -emitting additives include lime and/or dolomite. The inert additives dilute the sodium carbonate and sodium chromate, which both melt at the reaction temperature. In the low-lime process the carbonates evolve  $\text{CO}_2$ , decrease the reaction temperature to below  $1000^\circ\text{C}$ , and raise the melting point of the reaction products; the amount of lime added must be controlled so that the compound  $5\text{Na}_2\text{CrO}_4 \cdot \text{CaCrO}_4$  [43] is produced in the roast. Temperatures above  $1150^\circ\text{C}$  must be avoided because they result in the subsidiary components of the ore being attacked. At still higher temperatures the degree of conversion is markedly decreased. The optimum temperature range is very narrow and depends strongly on the type of ore used and the composition of the mixture.

**Process Description.** A typical roast mixture contains 100 parts of ore, 60–75 parts of sodium carbonate, 0–100 parts of lime or dolomite, and 50–200 parts of inert materials. The components are first finely ground, then mixed, and fed into the furnace. Annular hearth furnaces or rotary kilns are commonly used in large plants today.

The *annular hearth furnace* (Figure 46.4) is made from steel with a refractory lining (inner diameter ca. 20 m; outer diameter ca. 30 m); it is driven by a gear wheel underneath and has rails running on rollers. The rotating hearth is

sealed from the stationary parts of the furnace by sheets of metal dipping into annular water troughs. The furnace is heated by several burners from the side or from the top with gas, coal dust, or oil. The exhaust gas can be utilized to preheat the burner air or to generate steam. The mixture is fed to the outer edge of the annular hearth by a feed screw. A water-cooled ribbon screw transports the mixture inward, each time the annular hearth revolves, and finally removes it in the middle.

In the annular hearth furnace, the mixture is uniformly heated to the reaction temperature and made to travel toward the center of the hearth with a well-defined layer thickness. The furnace process is fairly independent of the sintering of the roast; it allows the production of melts that contain 40% of water-soluble sodium chromate. The yield is 80–95%, based on the chromite feed. The roast takes 2–6 h, depending on the composition of the mix.

Most of the kiln tube of the *rotary kiln* (Figure 46.5) between the feed point and the reaction zone is used to heat the mixture. Shortly before the mix reaches the actual reaction zone, the soda melts and calcines. At this point the mixture bakes, and pellets or wreath-shaped cakes may be formed. If the furnace is operated inexpertly (temperature too high) or the composition of the mixture is wrong (too little carrier material) the kiln tube may get substantially clogged. In such cases, the constriction can be cleared by using an industrial gun.

The roast from the rotary kiln contains up to 30% of water-soluble sodium chromate. The yield is 75–90%, based on the chromite feed. The roast takes 3–8 h, depending on the composition of the mixture. The hot exhaust gas from the rotary kiln can be used to preheat the burner air.

**Gas Purification.** Exhaust gas purification systems able to achieve a high degree of separation are required for dust collection. They essentially consist of two components: (1) an exhaust gas cooling system, with optional energy recovery, for example, steam generation; and (2) the exhaust gas purification system, usually an electrostatic separator.

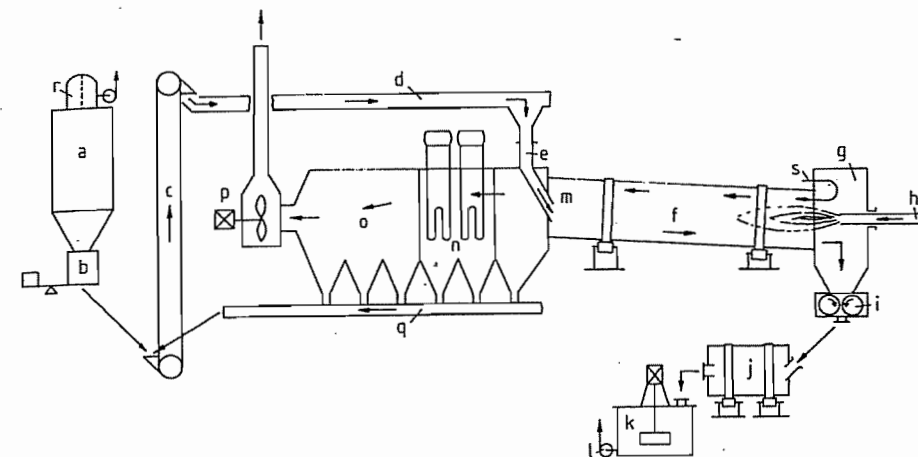

**Figure 46.5:** Rotary kiln for roasting chromium ores: a) Mixture silo; b) Scales; c) Elevator; d) Drag chain; e) Inlet tube; f) Rotary kiln; g) Burner; h) Combustion chamber; i) Crusher; j) Wet tube mill; k) Stirred vessel; l) Pump for filtering system; m) Kiln inlet; n) Waste heat boiler; o) Electrostatic gas purification; p) Exhaust gas fan; q) Dust drag chain; r) Bin filter; s) Air inlet.

The size and the design of the purification system depend on the type of furnace. In the rotary kiln, ca. 10% of the feed mixture is carried off by the exhaust gas, whereas in the annular hearth furnace, less than 1% is carried off. However, operation of the annular hearth furnace necessitates a considerable expenditure on gas cooling.

**Other Processes.** In the literature, other processes are proposed but so far these have not achieved any industrial significance. Thus, attempts have been made to roast chromium ore in a shaft furnace [44] or in a fluidized-bed reactor [45]. A fundamentally different process involves the reaction of the chromium ore and soda in a molten salt mixture with oxygen-containing gases being injected [46].

#### 46.9.1.2 Leaching of the Roast

After the oxidative process, the roast is a mixture of soluble salts and insoluble components. It contains sodium chromate, sodium aluminate, magnesium oxide, sodium vanadate(V), iron(III) oxide, unused alkali, unchanged chromite, and small amounts of sodium chloride originating from the soda.

When the roast is extracted with hot water, a pH of 10.5–11.2 results. The pH is controlled

by adding acids or carbonates so that all chromate dissolves, whereas the alkali-soluble impurities hydrolyze and form a readily filterable precipitate along with the iron hydroxide and the unchanged ore components.

The roast is first cooled on a Fuller grate or in a cooling drum. Then it is either ground in a wet tube mill after addition of water or wash solution (see below) with carbonates or acids added, or it is dissolved in a stirred vessel. The insoluble residue is separated from the sodium chromate solution and thoroughly washed with a countercurrent of water. Nowadays continuous multistage Dorr plants or rotary filters are used; after separation, the insoluble residue is extracted two to three more times in countercurrent. Dorr plants only exhibit satisfactory separation of residue and solution if the sodium chromate concentration is not too high. Rotary filter plants can be employed without difficulty for nearly saturated hot sodium chromate solutions; such filters are frequently preferred because the higher water consumption of the Dorr plant results in unnecessary steam costs in the subsequent evaporation process.

After removal of residual aluminum hydroxide and other undissolved components in a final purification process (e.g., thickener),

the concentrated sodium chromate solution is acidified (Section 46.9.1.3).

Some of the filter residue is dried and added to the roasting mix. The remainder is subjected to reducing treatment to convert the residual chromate content into an ecologically harmless form. To do this, the residue is suspended in water and treated with sulfuric acid and sodium hydrogen sulfite or iron(II) sulfate; chromate residues are converted into chromium(III) compounds in this way. Subsequent addition of alkali precipitates trivalent chromium (and iron(III), if present) as hydroxide. The suspension is then filtered and the cake (optionally after further removal of water) is dumped.

### 46.9.1.3 Acidification

The sodium chromate solution is converted into sodium dichromate solution by acidification with sulfuric acid (Equation 3) or carbon dioxide (Equation 4). The sequence of individual steps depends on the acid.

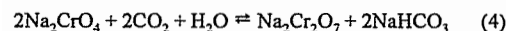
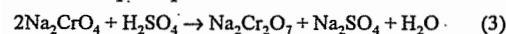

**Sulfuric Acid Acidification.** Sulfuric acid is added to the concentrated sodium monochromate solution in an agitated vessel until the pH is about 4. The sodium dichromate solution is then concentrated in a continuous evaporation plant. Each liter of sodium dichromate solution yields 400–500 g of anhydrous crystalline sodium sulfate. The sulfate is removed by centrifugation. The clear, dark-red sodium dichromate solution contains 900–1200 g of  $\text{Na}_2\text{Cr}_2\text{O}_7 \cdot 2\text{H}_2\text{O}$  per liter and additional small amounts of sodium sulfate; it is dispatched in tanks, e.g., of steel. The solution is either used directly as an oxidizing agent or processed to yield dichromate crystals.

**Carbon Dioxide Acidification.** After filtration the sodium monochromate solution from the first filtration stage is concentrated to ca. 850 g of  $\text{Na}_2\text{CrO}_4$  per liter. The saturated sodium chromate solution is then acidified with a countercurrent of carbon dioxide at 0.5–1.5 MPa (510 bar) to yield sodium dichromate and

sodium hydrogen carbonate. A series of stirred autoclaves is preferred for this reaction. They must be cooled to remove the heat of neutralization; the slurry leaves the last reactor at room temperature. The degree of conversion is about 80–90%.

The sodium hydrogen carbonate is removed by centrifugation or filtration, preferably under pressure to prevent reaction (4) from being reversed. After it has been washed, water can be removed in a pusher centrifuge. Still moist, the sodium hydrogen carbonate is then transferred to a calcining furnace. The carbon dioxide produced in the furnace may be fed back to the acidification autoclaves [25]; the sodium carbonate obtained is recycled for alkaline ore roasting [47].

To obtain commercial sodium dichromate solution, further evaporation to a concentration of 1000 g of sodium dichromate per liter is required. This is then followed by a second acidification with carbon dioxide or sulfuric acid.

Production of soda is the main advantage of carbon dioxide acidification. However, this is offset by a number of difficulties, particularly the formation of deposits on the evaporator during the concentration of the sodium monochromate solution. Other problems include mastering the pressure technology and cooling, separation of the sodium hydrogen carbonate, yield loss due to reverse reaction, and clogging of the calcination furnace.

### 46.9.1.4 Crystallization

For the purpose of crystallization the sodium dichromate solution (950–1200 g/L) is further concentrated and may, if necessary, be filtered while hot to remove additional sodium sulfate or sodium chromate. It is then slowly cooled to 30–35 °C with constant stirring to obtain orange-red crystals of  $\text{Na}_2\text{Cr}_2\text{O}_7 \cdot 2\text{H}_2\text{O}$ .

Today continuous vacuum crystallization is carried out to an increasing extent. The initial difficulties of this process, particularly in obtaining coarse, dust-free crystals, have largely been overcome. The crystalline slurry is continuously separated from the mother liquor

and dried. Precise control of the drying temperature is important because hydrated sodium dichromate is converted into anhydrous sodium dichromate above 84.6 °C and, therefore, cakes if overheated.

For reasons of occupational health, care should be taken to ensure that workplaces and production plants are dust free when sodium dichromate, especially the dried product, is being handled. In such locations, extensive ventilation and dust removal systems (wet scrubbers, electrostatic separators) are necessary.

## 46.9.2 Chromium Oxides

### 46.9.2.1 Chromium(III) Oxide and Chromium Hydroxide

**Chromium(III) oxide**,  $\text{Cr}_2\text{O}_3$ ,  $\rho$  5.2 g/cm<sup>3</sup>, is green in finely dispersed form, whereas fairly large crystals have a blackish green hue and a metallic luster. The crystals have a hexagonal rhombohedral structure of the corundum type. The compound melts at 2435 °C, but begins to evaporate at 2000 °C to form clouds of green smoke; the boiling point is estimated to be 3000–4000 °C. The enthalpy of formation is –1141 kJ/mol. Macrocrystalline chromium(III) oxide has a hardness of 9 on the Mohs scale. An amorphous form of the oxide is also known; this crystallizes on heating.

Chromium(III) oxide does not dissolve in water, acid, alkali, or alcohols. It is converted by a molten bath of sodium peroxide into soluble sodium monochromate(VI). Chromium(III) oxide and chromates(III) are used in organic chemistry as catalysts, e.g., in the hydrogenation of esters or aldehydes to form alcohols and in the cyclization of hydrocarbons. They also catalyze the formation of ammonia from hydrogen and nitrogen.

**Production.** The industrial production of chromium(III) oxide involves the reduction of solid sodium dichromate, generally with sulfur. The finely divided components are thoroughly mixed, fed into a brick-lined furnace, and brought to dark-red heat. The reaction

proceeds exothermically. After the reaction mass has cooled, it is broken up and the sodium sulfate produced is leached out with water. The remaining solid is separated, rinsed, dried, and ground. To obtain 100 kg of chromium(III) oxide, 200 kg of sodium dichromate must react with at least 22 kg of sulfur; usually an excess of sulfur is used. Additives such as ammonium chloride or starch in the crude mixture affect the pigment properties. When sodium dichromate is replaced by the corresponding potassium salt, the hue of the pigment becomes more bluish.

The compound can also be prepared by a wet route involving reduction of sodium chromate by sulfur [48] with sodium thiosulfate being produced as a coproduct. The hydrate initially obtained is washed by decanting, filtered, and calcined to form the oxide.

Chromium(III) oxide destined for aluminothermic production of pure chromium metal must be heated additionally at 1000 °C to increase its grain size. If products particularly low in sulfur are to be produced for this purpose, charcoal can be used for the reduction instead of sulfur. High-purity oxides can also be obtained by thermal decomposition of chromium(VI) oxide or ammonium dichromate(VI), the latter yielding a material of very low density.

**Chromium(III) oxide pigments** contain 99.1–99.5%  $\text{Cr}_2\text{O}_3$ . The aluminum oxide and silicon dioxide impurities each amount to ca. 0.1%; the annealing loss at 1000 °C is about 0.3%. The individual particles are spherical, with a diameter of 0.3  $\mu\text{m}$  predominating. Chromium(III) oxide finds widespread application as a green pigment resistant to atmospheric conditions and heat. In addition, it is used as a colorant in glass products and printing inks, as a vitrifiable pigment in the ceramics industry, and as a polishing agent because of its considerable hardness.

**Chromium(III) Aquoxides.** Pure chromium(III) hydroxide,  $\text{Cr}(\text{OH})_3$ , can only be prepared with difficulty because the hydrates initially obtained by precipitation are subject to aging.

After drying in air, specimens prepared by precipitation with alkali in the cold from violet chromium(III) salt solutions have a composition corresponding to  $\text{Cr}_2\text{O}_3 \cdot 9\text{H}_2\text{O}$ , and are usually formulated as  $\text{Cr}(\text{H}_2\text{O})_3(\text{OH})_3$ . They are bright bluish green powders with limited life. All three hydroxyl groups react immediately with acids. Upon careful heating, dehydration occurs in steps and compounds containing 8, 5, 3, and 1 mol of water are formed. The density increases as the water content falls. Above 50 °C, conversion to a gelatinous green aging product occurs, and the solubility and chemical reactivity decrease; oxygen bridges are formed through the elimination of water, and polynuclear complexes are produced. The composition approaches that of chromium(III) oxide hydroxide,  $\text{CrO}(\text{OH})$ . Aging is accelerated by the presence of hydroxide ions.

In freshly precipitated hydroxides a crystalline phase isomorphous with bayerite [ $\text{Al}(\text{OH})_3$ ] is observed, whereas aged compounds are X-ray amorphous. The chromium(III) hydroxide hydrates are amphoteric compounds. With acids they form  $\text{Cr}^{3+}$  salts, whereas they dissolve in strong hydroxide solution to form chromates(III), e.g., the deep green sodium chromate(III),  $\text{Na}_2\text{Cr}_2\text{O}_4$  (previously known as sodium chromite). When ammonium hydroxide is added, red solutions are formed. Oxidizing agents in the presence of alkali produce chromates(VI). With halogens this takes place immediately on gentle heating, but with oxygen several hours are required at a pressure of 4 MPa (40 bar) at 175 °C.

Chromium(III) hydroxide forms a stable colloid solution, whose isoelectric point is at pH 5. At higher pH the sol becomes negatively charged and adsorbs cations, whereas below pH 5 the charge is positive and anions are adsorbed. The adsorption capacity of chromium(III) hydroxide sols is higher than that of aluminum or iron(III) hydroxide sols. Sols containing 127 g of  $\text{Cr}_2\text{O}_3$  per liter have been obtained from concentrated chromium(III) chloride solution by addition of ammonium carbonate and dialysis while the solution is hot [49].

**Production.** In industry chromium(III) hydroxide hydrates are usually produced from solutions of chromium(III) sulfate or chromium alum by precipitation with soda, sodium hydroxide solution, or ammonium hydroxide. Production by reduction of sodium chromate with sodium sulfide [50] has also been proposed.

For production from potassium chromium alum 54 kg of soda is dissolved in 300 L of water and a solution of 180 kg of alum in 900 L of water is added slowly. After the evolution of carbon dioxide has subsided, about 220 kg of moist chromium hydroxide containing 12%  $\text{Cr}_2\text{O}_3$  is obtained by filtration. Chromium(III) hydroxide hydrates are used for the production of chromium(III) salts by reaction with the corresponding acids.

**Hydrated chromium(III) oxide**,  $\text{Cr}_2\text{O}_3 \cdot x\text{H}_2\text{O}$ , is a brilliant emerald-green pigment known as Guignet's green that consists of very finely divided chromium(III) oxide to which water is bonded by adsorption. It is produced by heating a ground mixture of one part by weight of potassium dichromate and three parts by weight of boric acid in a muffle furnace to a faint red heat, which results in the formation of chromium(III) and potassium tetraborates. The molten mass still contains 6–7% water and, after cooling, already has a deep green color. When this mass is boiled with water, it decomposes into chromium(III) oxide hydrate and boric acid. The product is coarse-grained and difficult to grind. Use of sodium dichromate as raw material results in a more yellowish color, whereas addition of thiourea or polysulfide to the reaction mixture produces a pigment with a bluish hue. The composition of the commercial products varies; typical values are:  $\text{Cr}_2\text{O}_3$  79.3–82.5%,  $\text{H}_2\text{O}$  16.0–18.0%,  $\text{B}_2\text{O}_3$  1.5–2.7%.

**Hydrated chromium oxide green** is a pigment with properties similar to those of Guignet's green but with a somewhat less intensive coloration. This pigment is prepared by reducing sodium chromate or sodium dichromate in aqueous solution with sulfur or sodium formate in a stirred autoclave or pressure tube [51]. The temperature required is

250–270 °C. The solid is separated by filtration, washed, dried, and ground. The finished pigment consists of fine needles, with a particle size of  $0.02 \times 0.1 \mu\text{m}$  predominating. The product contains 79–80%  $\text{Cr}_2\text{O}_3$ , the annealing loss is about 19%, and the density 3.7 g/cm<sup>3</sup>. The coloration changes at elevated temperature. Because of its high reflecting power at infrared wavelengths the product had at times been of special importance in camouflage paints.

#### 46.9.2.2 Chromium(IV) Oxide (Chromium Dioxide)

WÖHLER discovered ferromagnetic chromium dioxide in 1859 when he decomposed chromyl chloride [52]. About 100 years later, Du Pont produced it in pure form by decomposition of chromic acid under hydrothermal conditions [53, 54]. Industrial exploitation began after the morphological and magnetic properties had been modified by doping chromium dioxide with heavy metals [55, 56] in order to meet the requirements for a magnetic pigment [57]. The marketing of chromium dioxide at the beginning of the seventies initiated the development of cobalt-doped iron oxides which are nowadays used as an alternative to chromium dioxide for information storage.

**Physical and Chemical Properties** [58]. Chromium dioxide,  $\text{CrO}_2$ , crystallizes in black tetragonal needles. The lattice is of the rutile type and belongs to the space group 4/mmm. The dimensions of the unit cell are  $a = b = 44.21 \text{ nm}$  and  $c = 29.16 \text{ nm}$ . The X-ray density is 4.89 g/cm<sup>3</sup>, and the phase width is between  $\text{CrO}_{1.89}$  and  $\text{CrO}_{2.02}$  [59]. The enthalpy of formation is  $-590 \text{ kJ/mol}$  [60]. The temperature coefficient for the  $c$ -axis is negative [61]. At 100 °C, agglomerated blocks have a linear coefficient of expansion of  $-6 \times 10^{-6} \text{ K}^{-1}$  [62].

At room temperature chromium dioxide is ferromagnetic, the magnetic moment being 2 Bohr magnetons. The Curie temperature is 120 °C and increases to 155 °C as a result of doping with iron [63]. Finely crystalline nee-

dle-shaped chromium dioxide has a specific magnetic saturation  $M_s/\rho$  of 77–92 Am<sup>2</sup>/kg, whereas in single crystals  $M_s/\rho$  rises to 100 Am<sup>2</sup>/kg [55]. The magnetocrystalline anisotropy constant is  $22 \times 10^3 \text{ J/m}^3$  [64]. The coercivity  $H_c$  depends on the size of the crystals and on their shape and magnetocrystalline anisotropies. The coercivity is affected to differing extents by various heavy metals [65]. Iron, antimony, and tellurium increase  $H_c$  from 35 kA/m to 60 kA/m, whereas iridium increases it to 220 kA/m [66].

Chromium dioxide behaves as a metallic conductor [58, 67], with a specific electrical resistivity between  $2.5 \times 10^{-4}$  and  $4 \times 10^{-2} \Omega\text{cm}$  [61, 68].

At room temperature and normal pressure chromium dioxide is metastable; when heated to temperatures above 350 °C, it decomposes into chromium(III) oxide and oxygen. Chromium dioxide has an oxidizing action on reactive organic compounds [69]; the reactivity is considerably decreased by enveloping it with iron(III) and chromium(III) oxides [70–72]. Chromium dioxide is insoluble in water. Reaction with water occurs at the crystal surface, with disproportionation to chromate and  $\text{Cr}^{3+}$  ions. The aqueous suspension has a pH of 3. However, chromium dioxide is soluble in concentrated sulfuric acid or concentrated alkali solution.

**Production** [73]. Chromium dioxide is made by decomposition of chromyl chloride, chromic acid anhydride [73], and chromium(III) chromate [74], or by oxidation of chromium(III) compounds with oxygen, hydrogen peroxide, chromic acid anhydride [75], or ammonium perchlorate [66].

Industrial production employs a process originally carried out under licence from Du Pont [65], which involves hydrothermal oxidation of chromium(III) oxide with excess chromic acid:

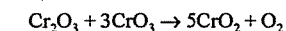

Iron(III) oxide and antimony(III) oxide are used as a dopant. Finely divided chromium(III) oxide is obtained either by thermal decomposition of ammonium dichromate or

by dehydration of chromium(III) hydroxide [75].

A highly viscous paste (50–100 Pa·s) is produced by intensively homogenizing the starting materials. This paste is heated at 300 °C and 35 MPa (350 bar) to form a hard agglomerate of fine chromium dioxide needles which must be drilled out of the reactor trays, broken, and carefully ground. If the residual moisture exceeds 5%, the product is reheated in a rotary kiln. The chromium dioxide is deagglomerated in an aqueous sodium sulfite suspension, and the crystal surface is simultaneously reduced; this forms a chromium(III) oxide hydroxide layer about 1 nm thick. To do this, the suspension is circulated through a mill which generates intense shear fields and the fine component is removed by using a hydrocyclone. After filtration and washing, drying is carried out in a spray tower. The chromium dioxide obtained has a bulk density of 0.8 g/cm<sup>3</sup>.

Production is carried out to a large extent in closed equipment. Less than 2 mg of dust is emitted per 1 m<sup>3</sup> of exhaust air (STP). The chromium-containing wastewater from the production is worked up by reduction.

**Use and Economic Importance.** Chromium dioxide is used as a magnetic pigment. So far no other uses have achieved any significance [56].

In the audio field, chromium dioxide is used in mono- and multilayer tapes, the layers in the latter containing chromium dioxide of different coercivity. In video tapes, it is employed either on its own or mixed with cobalt-doped iron oxides. Because of its low Curie point, chromium dioxide allows high-speed thermomagnetic copying of prerecorded audio and video tapes [76]. Chromium dioxide has been used in digital data storage since 1985. Since the magnetostriction of chromium dioxide is low, repeated playing results in virtually no level losses [77]. Table 46.9 contains data on chromium dioxide powder intended for various applications.

In 1984 the demand for magnetic pigments was about 50 000 t, about 10% of this being chromium dioxide. The most important manufacturers are Du Pont (United States) and BASF (Germany). In addition, there is a chromium dioxide plant in the former Soviet Union.

### 46.9.2.3 Chromium(VI) Oxide

Chromium trioxide, chromic acid anhydride, chromic acid, CrO<sub>3</sub>,  $\rho$  2.7 g/cm<sup>3</sup>, forms dark red crystals which deliquesce in air. The enthalpy of formation is –594.5 kJ/mol. The oxide melts at 198 °C and starts to decompose, giving off oxygen and brownish red vapors with a pungent smell. The rate of decomposition reaches a maximum at 290 °C, chromium(III) oxide, Cr<sub>2</sub>O<sub>3</sub>, being produced as the final product via various intermediate stages. Chromium(VI) oxide dissolves in water to form chromic acids; the solubility depends only slightly on temperature. A saturated solution contains 166 g of CrO<sub>3</sub> at 20 °C and 199 g of CrO<sub>3</sub> at 90 °C per 100 mL of water. The compound also dissolves in sulfuric acid and nitric acid. Chromium(VI) oxide is a powerful oxidizing agent, particularly in the presence of acids. Reactions with alkali metals and numerous organic compounds, e.g., low-boiling hydrocarbons, acetone, or benzene and its derivatives, proceed explosively with considerable heat being produced. Esters of chromic acid are also known, e.g., with such cyclic tertiary alcohols as methylfenchol and methylborneol.

Chromium(VI) oxide is made by the reaction of sodium dichromate with sulfuric acid. The reaction can be carried out with solid sodium dichromate or with solutions or suspensions. Both methods are in use industrially.

The reaction proceeds rapidly and completely after the components have been mixed, with heat being evolved. Isolation of chromium(VI) oxide from the reaction mixture or purification of the crude product obtained from the aqueous solution is difficult.

Table 46.9: Powder data for typical chromium dioxide pigments.

| Application  | Particle geometry                    |                           |         |  | Magnetic data <sup>a</sup> |                                  |                                  |
|--------------|--------------------------------------|---------------------------|---------|--|----------------------------|----------------------------------|----------------------------------|
|              | SSA <sup>b</sup> , m <sup>2</sup> /g | $\bar{r}$ , $\mu\text{m}$ | $l/d^d$ | $V^d$ , 10 <sup>-4</sup> $\mu\text{m}^3$ | $H_c$ , kA/m               | $M_s/\rho$ , Am <sup>2</sup> /kg | $M_p/\rho$ , Am <sup>2</sup> /kg |
| Audio        | 28                                   | 0.29                      | 9       | 2.5                                      | 41                         | 35                               | 77                               |
| Video        | 35                                   | 0.29                      | 11      | 1.5                                      | 49                         | 34                               | 74                               |
| Data storage | 24                                   | 0.32                      | 8       | 3.5                                      | 39                         | 35.5                             | 79                               |

<sup>a</sup> Measured with a vibration magnetometer,  $H_m = 800$  kA/m.

<sup>b</sup> Specific surface area (SSA) determined by N<sub>2</sub> adsorption using the BET method (1-point measurement).

<sup>c</sup> Mean length  $l$  determined by electron microscope photography with a magnification of 20 000 times.

<sup>d</sup> Diameter  $d$  and volume  $V$  calculated from SSA and  $l$ .

Quantitative separation of sodium hydrogen sulfate is possible only if the chromium(VI) oxide is melted, but at this temperature the product begins to decompose. The melting process must therefore be controlled very precisely.

**Dry Process.** Even today the old discontinuous process is in use to some extent. The reaction vessels are made from carbon steel or stainless steel. The conical containers are equipped with stirrer, exhaust facilities, and external heating. Sulfuric acid and sodium dichromate are added simultaneously with stirring. The paste heats up to 80 °C during mixing and is heated further to evaporate water. At 170 °C sodium hydrogen sulfate melts, followed by chromium(VI) oxide at 198 °C. As soon as the reaction products are liquid, the heating and the stirrer are turned off. After a few minutes the heavier chromium(VI) oxide ( $\rho$  2.2 g/cm<sup>3</sup>) settles at the bottom, and is covered by a layer of the lighter sodium hydrogen sulfate ( $\rho$  2.0 g/cm<sup>3</sup>). Liquid chromium(VI) oxide is drawn off the bottom and conveyed to a cooling drum where it solidifies to form scales. Sodium hydrogen sulfate is subsequently drained. The yield of chromium(VI) oxide is about 85%; 175 kg of sodium dichromate and 140 kg of 96% sulfuric acid are required to obtain 100 kg of chromium(VI) oxide. About 150 kg of sodium hydrogen sulfate is obtained as by-product.

Figure 46.6 shows a continuous dry process [78]. The raw materials are fed to a mixing screw for intimate mixing. A viscous paste of chromium(VI) oxide, sodium hydrogen sulfate, and water forms which is fed into a heated rotary kiln of stainless steel where it is melted. The heating must be controlled very

carefully. The melt flows into a separator, where the heavier chromium(VI) oxide collects at the bottom of the trough, is removed by means of a rising pipe, and is converted into scales on cooling drums. The upper sodium hydrogen sulfate layer leaves the separating cell via an overflow and is also cooled on drums. Exhaust air from the various pieces of equipment is purified in a wash tower. The yield of this process is over 90%.

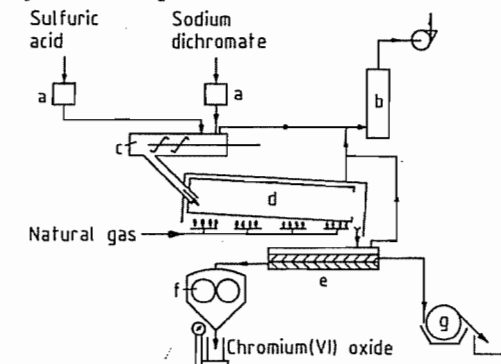

Figure 46.6: Continuous production of chromium(VI) oxide: a) Metering device; b) Wash tower; c) Mixer; d) Rotary kiln; e) Separation cell; f) Cooling drum for chromium(VI) oxide; g) Cooling drum for sodium hydrogen sulfate.

If a highly concentrated solution is used instead of dichromate crystals, the kiln can be heated directly [79].

**Wet Process.** A hot saturated solution of sodium dichromate, which may still contain dichromate crystals, reacts with sulfuric acid [80]. In the course of 30–60 min the chromium(VI) oxide precipitates from the hot solution. On filtration a crude product is obtained, with a yield of about 80%. Sodium hydrogen sulfate must be removed from the crude product by fusion. The filtrate can be re-



cycled for converting sodium monochromate into dichromate, it can also be used in a fresh reaction mixture [81] if sodium hydrogen sulfate is first crystallized and removed at 20–25 °C. The crude chromium(VI) oxide is purified by continuous successive fusion and decanting [82].

As an alternative to production by reaction with sulfuric acid, Diamond–Shamrock developed an electrochemical process [83–85] in which chromic acid is produced from sodium dichromate in a two- or three-compartment cell.

Chromium trioxide is usually sold in the form of flakes, but the coarsely or finely ground product is also marketed. Good commercial products contain 99.5–99.7% CrO<sub>3</sub> and a maximum of 0.1% of sulfate. In the form of flakes, the product has a bulk density of 1.1 kg/L whereas that of the ground product is 1.4 kg/L. Steel drums must be used as containers and they must be tightly sealed because the product absorbs moisture from the air.

Chromium trioxide is classified as a dangerous substance in the EEC list and must be marked as fire-promoting and corrosive. In the IMDG code chromic acid has been put in class 5.1., UN No. 1463. The MAK of CrO<sub>3</sub> is 0.1 mg/m<sup>3</sup>.

Electroplating is the most important field of application of chromium(VI) oxide. Numerous mixtures containing chromium trioxide are on the market; these “compounds” often contain hexafluorosilicates which improve the properties of the chromium coatings. Chromic acid solutions are also used for passivating zinc, aluminum, cadmium, and brass. Proprietary mixtures predominantly contain additions of fluoride, nitrate, and phosphate ions. Other uses for chromic acid are in the production of chromium dioxide and in wood preservation.

## 46.9.3 Chromium(III) Salts

### 46.9.3.1 General Properties

**Water Content.** In contrast to many other inorganic salts, chromium(III) salts occur in a variety of forms that depend on water content and on the particular conditions under which they are formed. Anhydrous compounds do not dissolve in pure water.

However, some of them, e.g., chromium(III) chloride or chromium(III) sulfate, dissolve in the presence of chromium(II) ions. In this process, one dissolved divalent ion transfers an electron via an anion bridge to a trivalent chromium ion in the solid crystal. Having become divalent, this ion detaches itself, acts in a similar manner on another chromium(III) ion in the crystal array, and reverts again to the trivalent state.

**Complex Formation.** Dissolved chromium(III) ions are always coordinated by various ligands. In the simplest case of the hexaaquochromium(III) ion, [Cr(H<sub>2</sub>O)<sub>6</sub>]<sup>3+</sup>, six water molecules surround the central chromium ion in an octahedral arrangement as ligands. In addition to the aquo complexes, numerous coordination compounds with other molecules are known, and research on them, particularly studies of the ammine complexes (NH<sub>3</sub> as ligand), has played an important part in the development of coordination compound chemistry [86].

When negatively charged ligands enter the chromium complex, the charge is decreased appropriately. If the sum of the negative charges is four or more, the complex becomes anionic, an example of this being the diaquodisulfatochromium(III) ion [Cr(SO<sub>4</sub>)<sub>2</sub>(H<sub>2</sub>O)<sub>2</sub>]<sup>−</sup>. In this case, each sulfate radical with a double negative charge occupies the position of two ligands.

The tendency of negatively charged ligands to form complex compounds with chromium increases in the following order:

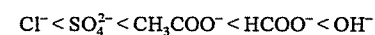

Nitrato complexes are unknown.

**Hydrate Isomerism.** Chromium(III) complexes exhibit hydrate isomerism due to the positioning of anions and water molecules. Thus chromium(III) chloride hexahydrate E<sub>−</sub> is known in three different forms:

- Hexaaquochromium(III) chloride, [Cr(H<sub>2</sub>O)<sub>6</sub>]Cl<sub>3</sub>, bluish grey
- Pentaquochlorochromium(III) chloride hydrate [Cr(H<sub>2</sub>O)<sub>5</sub>Cl]Cl<sub>2</sub>·H<sub>2</sub>O, bright green
- Tetraaquodichlorochromium(III) chloride dihydrate [Cr(H<sub>2</sub>O)<sub>4</sub>Cl<sub>2</sub>]Cl·2H<sub>2</sub>O, dark green

The anions that are directly bound to the central atom do not dissociate in water and consequently do not react with the common precipitating agents; therefore, in the two green chlorides, only one-half and one-third of the chloride ions, respectively, are precipitated by silver nitrate.

**Basic Salts.** Hydroxide ions form coordinate bonds, with central ion of the hexaaquochromium complex being hydrolyzed. In this process, the pentaquohydroxochromium(III) ion with a double positive charge is first formed:

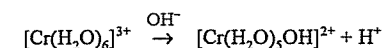

When more alkali is added, chromium hydroxides are precipitated immediately. Finally, with a strong hydroxide solution, a soluble deep green hydroxo salt is produced:

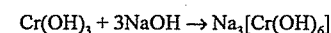

Pentaquohydroxochromium(III) complexes are very weak bases. Their salts hydrolyze and the pH of aqueous solutions usually is 2. The basicity of these salts is defined as the ratio of hydroxyl groups (in percent) bound to chromium to the number of hydroxyl groups in chromium(III) hydroxide, that could theoretically be bound to chromium. Pentaquohydroxochromium(III) complexes therefore have a basicity of 33%. When a second hydroxyl group enters the complex the basicity increases to 67%. However, from a basicity of 60% onward, chromium(III) hydroxide precipitates and these compounds are not used in practice.

### 46.9.3.2 Chromium(III) Sulfates and Chrome Tanning Agents

**Chromium(III) Sulfate.** *Anhydrous chromium sulfate*, Cr<sub>2</sub>(SO<sub>4</sub>)<sub>3</sub>, ρ 3.0 g/cm<sup>3</sup>, is a violet powder which is insoluble in water but dissolves to form complexes when reducing agents are added. For its preparation, chromium metal or chromite is heated over 250 °C with sulfuric acid.

The *octadecahydrate*, [Cr(H<sub>2</sub>O)<sub>6</sub>]<sub>2</sub>(SO<sub>4</sub>)<sub>3</sub>·6H<sub>2</sub>O, ρ 1.86 g/cm<sup>3</sup>, forms cubic crystals. The violet compound gives off water on heating and above 70 °C it is converted, with further loss of water, into a dark-green crystalline *pentadecahydrate*. As the water content diminishes, the solubility decreases.

*Solutions* of chromium(III) sulfates can be made by treating chromite with sulfuric acid in the presence of chromium(VI) compounds [87]. Since other components of the ore are solubilized at the same time, the solutions are strongly contaminated; separation of magnesium, aluminum, and iron presents such great difficulties that this process has not yet gone beyond the experimental scale. Chromium(III) sulfate solutions are also obtained by dissolving ferrochromium in sulfuric acid, a process in which iron(II) sulfate is obtained as a co-product. So far, the economical preparation of a pure product has been only partially successful.

Large quantities of chromium(III) sulfate solution are produced in the oxidation of organic substances with chromic acid or sodium dichromate in sulfuric acid solution. Examples of this are the preparation of anthraquinone from anthracene, the preparation of benzoquinone from aniline, or the bleaching of montan wax. These solutions are used to produce other chromium products; an electrolytic regeneration to dichromate is also possible.

**Tanning Agents.** *Basic chromium(III) sulfates* are used on a large scale as tanning agents for leather. Industrially, two processes are available for the reduction of sodium dichromate: (1) reaction with organic compounds (molasses, sugar) in the presence of

sulfuric acid and (2) reduction with sulfur dioxide.

*Reduction with molasses* is carried out in aqueous solution; about 30 kg of molasses or 15 kg of cane sugar is required for 100 kg of sodium dichromate dihydrate. The amount of sulfuric acid required depends on the desired basicity. To adjust the basicity to 33%, about 103 kg of 96% acid is needed. The reaction is strongly exothermic; water evaporates in abundance and must be continuously replenished. Lead-lined vats have proved successful as reaction vessels. The exhaust gases have an unpleasant smell, but this can be eliminated by scrubbing with water in a wash tower or by heating them after condensing the water vapor.

The properties of the final product are, to a certain extent, dependent on how the reaction is performed. If sulfuric acid is added first to the dichromate solution and the reducing agent is then added slowly, relatively few organic acids are produced as result of side reactions. The proportion of these acids becomes considerably larger if the dichromate solution is mixed first with the reducing agent and the sulfuric acid is added last. The organic acids form chromium complexes and mask the tanning agent. This masking delays the tanning process.

In the *reduction with sulfur dioxide* sulfuric acid is generated in such proportions that the tanning agent produced has a basicity of 33%. For the reduction of 100 kg of sodium dichromate dihydrate, 65 kg of  $\text{SO}_2$  is theoretically required.

The reaction is carried out in lead-lined or brick-lined absorption towers containing ceramic packing material. Sulfur dioxide is produced by combustion of liquid sulfur which yields a gas containing 8–18%  $\text{SO}_2$ ;  $\text{SO}_2$ -containing gases from other manufacturing processes are also suitable for the reaction.

For the production of chrome tanning agents, chromium(III) sulfate solutions which are generated in the manufacture of organic intermediates may also be used. Impurities must be removed from such solutions, and the solutions are then converted to the correct basicity

by acidification or neutralization. They must also be concentrated by evaporation.

To manufacture *solid tanning agents*, the concentrated solutions are dried in spray driers made of stainless steel. With a basicity of 33%, the amorphous green powder obtained generally contains 24–26%  $\text{Cr}_2\text{O}_3$ , 25–27%  $\text{SO}_3$ , 22–25%  $\text{Na}_2\text{SO}_4$ , and 22–25% water. In air, the powder absorbs moisture and the particles stick together. Under the microscope, the individual particles, which are often hollow spheres or fragments of such spheres, have a glassy appearance.

The product obtained by spray drying is sold under numerous trade names, e.g., Chrometan (British Chrome and Chemicals, UK); Chromitan (BASF, Germany); Chromosal (Bayer, Germany); Salcromo (Stoppani, Italy); Tanolin (Hamblett & Hayes Co., Mass., USA).

Paper or jute sacks with watertight polyethylene liners or wrappings, or plastic sacks are used for packing.

Solutions of basic chromium(III) sulfate containing 12–18%  $\text{Cr}_2\text{O}_3$  are also available commercially. Solutions of higher concentration must be kept warm because sodium sulfate precipitates at room temperature. The solutions are transported in rubber-lined rail or road tankers; lead-lined tankers are also suitable.

Besides the standard 33% basic type, a large number of products of higher basicity are available. To improve their stability toward alkali, these contain various quantities of organic acids. The market importance of chrome tanning agents containing 30% chromium oxide and having a basicity of 50% has increased.

In addition to the standard products, mixtures of chrome tanning agents have established themselves on the market. These contain basifying agents which react slowly and eliminate the need for the tedious basifying process. Mixed products containing special organic masking agents and having a high total basicity have recently been developed. These are used in combination with conven-

tional chrome tanning agents and afford a high degree of chromium exhaustion in the liquors.

**Potassium chromium(III) sulfate**, potassium chrome alum,  $\text{KCr}(\text{SO}_4)_2 \cdot 12\text{H}_2\text{O}$ ,  $\rho$  1.813  $\text{g}/\text{cm}^3$ , crystallizes in the cubic system forming violet regular octahedra which decay in air and melt at 89 °C, the color changing to green; the enthalpy of formation is  $-5788$  kJ/mol. The solubility in water at 25 °C is 11.1%. The solution is violet when cold, but becomes green above 50 °C, this change being accompanied by a decrease in the molar conductance. For 0.125 M solution at 50 °C, the molar conductance is  $221 \Omega^{-1}\text{cm}^2\text{mol}^{-1}$  for the violet form and  $202 \Omega^{-1}\text{cm}^2\text{mol}^{-1}$  for the green form. This change is reversible and its rate is increased by acids. The green form always occurs as an amorphous solid and crystals are unknown.

In addition to the alum containing 12 molecules of water of crystallization, potassium chromium(III) sulfates containing one, two, and six molecules of water are known.

For the preparation of potassium chromium alum, a saturated potassium dichromate solution is reduced with sulfur dioxide in the presence of sulfuric acid.

During the reaction, the temperature must be kept below 40 °C by cooling to prevent the green modification being produced. Apart from sulfur dioxide, such organic compounds as formaldehyde, methanol, or starch are suitable as reducing agents. Crystallization starts after sulfuric acid has been added and the temperature is kept further below 40 °C. If the solution is allowed to settle in vats, large crystals are produced, whereas fine ones result if the solution is stirred. The industrial product contains 15%  $\text{Cr}_2\text{O}_3$  and 0.01–0.03% Fe. The mother liquor may be reused in the production of the alum solution, but after several cycles it is so enriched in magnesium and sodium sulfate that crystallization of the alum is retarded. The trivalent chromium is then precipitated from the solution with alkali and may be recycled. Lead-lined equipment is used for the production.

The alum can also be prepared from ferrochromium. The reaction with sulfuric acid first results in a solution of chromium(III) and iron(II) sulfates. The majority of the iron(II) sulfate can be removed by crystallization. With potassium sulfate added, the filtrate yields the alum which is contaminated with 0.1–0.2% Fe.

Potassium chrome alum was formerly used on a large scale as a tanning agent in the leather industry, but its importance in this field has receded with the introduction of the basic chromium sulfates. Other fields of application are the textile industry and the film and photographic industry.

**Ammonium chromium(III) sulfate**, ammonium chrome alum,  $\text{NH}_4\text{Cr}(\text{SO}_4)_2 \cdot 12\text{H}_2\text{O}$ ,  $\rho$  1.72  $\text{g}/\text{cm}^3$ , crystallizes in the cubic system forming bluish violet octahedra which appear ruby red when held against the light and slowly decay in air. When heated to 70 °C they turn green, and at 94 °C the compound melts in its water of crystallization. Ammonium chrome alum is obtained from chromium(III) sulfate solutions by addition of a stoichiometric amount of ammonium sulfate. Ammonium chrome alum crystallizes much more easily than potassium chrome alum. The preparation of ammonium chrome alum from carbon-rich ferrochromium has assumed relatively great importance in the electrochemical production of pure chromium metal [88].

#### 46.9.3.3 Other Chromium(III) Salts

**Chromium(III) fluoride**,  $\text{CrF}_3$ ,  $\rho$  3.8  $\text{g}/\text{cm}^3$ . The anhydrous compound forms highly refractive rhombohedral crystals. It melts above 1000 °C and is distinctly volatile between 1100 and 1200 °C. Chromium(III) fluoride is insoluble in water if no divalent chromium is present. Double compounds are formed with other metal fluorides, e.g., green  $\text{CrF}_3 \cdot 2\text{KF} \cdot \text{H}_2\text{O}$ .

*Hydrates* are known which contain three to nine molecules of water. The violet hexaquo-chromium(III) fluoride,  $[\text{Cr}(\text{H}_2\text{O})_6]\text{F}_3$ , and its

trihydrate,  $[\text{Cr}(\text{H}_2\text{O})_6]\text{F}_3 \cdot 3\text{H}_2\text{O}$ , can be obtained from hexaaquochromium(III) salt solutions and alkali fluorides. Products containing less water are green. The composition of the industrial product corresponds approximately to  $\text{CrF}_3 \cdot 3.5\text{H}_2\text{O}$  and the product contains about 30% chromium.

For the production of chromium(III) fluoride hydrate, chromium(III) oxide hydrate is dissolved in hot aqueous hydrofluoric acid and the green salt crystallizes. Chromium(III) fluoride is used in the textile industry for mordanting wool, for chromating dyestuffs, and in vigoureux printing. Recently, chromium(III) fluorides have also found application in rust-prevention paints as corrosion inhibitors.

**Chromium(III) Chloride.** *Anhydrous chromium(III) chloride*,  $\text{CrCl}_3$ , forms hexagonal reddish violet flakes which sublime at  $950^\circ\text{C}$  yielding a vapor that dissociates above  $1300^\circ\text{C}$ . The enthalpy of formation is  $-554.8$  kJ/mol. Chromium(III) chloride is insoluble in water if no reducing agent is present. On roasting in air, chromium(III) oxide is produced.

Anhydrous chromium(III) chloride is obtained along with iron(II) chloride by chlorinating roasting of chromite in the presence of carbon at  $900\text{--}1050^\circ\text{C}$  [89]. Oxygen is added to the chlorine to prevent nonvolatile residues, in particular minor constituents of the ore, from sintering together. Fractionating condensation between  $400$  and  $640^\circ\text{C}$  has been suggested for separating the chloride vapors [90]. The compound can also be obtained by chlorinating chromium(III) oxide in the presence of reducing agents or by treating ferrochromium with chlorine [91].

Chromium(III) chloride can be prepared readily from chromyl chloride by reaction with carbon monoxide and chlorine. The reaction proceeds rapidly in the gas phase at  $750\text{--}850^\circ\text{C}$  [92]. Since chromium(III) chloride evaporates only at a higher temperature, a considerable portion of the product, which varies as a function of the partial pressure, is produced in the form of fine crystals. As the smoke cools down, these act as crystallization nuclei for any gaseous chromium(III) chloride

still present. This procedure prevents the deposition of solid on the cooling surfaces.

Anhydrous chromium(III) chloride has been suggested for chromizing steel parts by surface diffusion; it can be used for the production of high-purity ductile chromium metal by reduction with magnesium and for the synthesis of organic chromium compounds.

*Chromium(III) chloride hexahydrate* is obtained in pure form by introducing hydrogen chloride and methanol into an aqueous solution of chromic acid. The reaction proceeds exothermally, and adequate cooling must be provided. Of the three isomeric hydrates the dihydrate of the tetraaquodichlorochromium(III) chloride crystallizes in the cold. This is used as an intermediate in the production of chromium complex dyes and other chromium salts, e.g., chromium stearates, which are of interest as impregnating agents for textiles or paper. The solution is also used as a mordant in the textile industry.

**Chromium(III) Acetate.** The bluish violet hexaquo salt,  $[\text{Cr}(\text{H}_2\text{O})_6](\text{CH}_3\text{COO})_3$ , forms needle-shaped crystals. Basic chromium(III) acetates are green. For their preparation chromium(III) hydroxide hydrate is dissolved in dilute acetic acid, and the solid is obtained by drying on drums or in a spray drier. Basic chromium acetates are used as mordants in calico printing and worsted top printing, and also for fixing vigoureux dyes. Combinations of basic chromium(III) acetate and basic chromium(III) formate also find application in the textile industry as mordants. In addition, chromium(III) acetate is used as a starting compound in the production of organic chromium dyes.

**Chromium(III) Nitrate.** Normally, chromium(III) nitrate crystallizes with nine molecules of water,  $[\text{Cr}(\text{H}_2\text{O})_6](\text{NO}_3)_3 \cdot 3\text{H}_2\text{O}$ ,  $\rho$   $1.8$  g/cm<sup>3</sup>. The dark violet rhombic prisms become green above  $36^\circ\text{C}$  and melt at  $66^\circ\text{C}$ . The nitrate group is not bound to the trivalent chromium in a coordination compound. The salt is readily soluble in water, acid, alkali, and alcohol. To prepare chromium(III) nitrate, chromium(III) oxide hydrate is dissolved in

nitric acid and the nitrate is allowed to crystallize. The compound is also produced by reduction of chromic acid with methanol in the presence of nitric acid. During the exothermal reaction, the temperature is kept between  $55$  and  $65^\circ\text{C}$  by cooling. Chromium(III) nitrate is used to a limited extent as a mordant in cotton printing, usually together with basic chromium acetates. In addition, the salt is suitable for producing alkali-free catalysts.

**Chromium(III) Phosphate.** *Anhydrous chromium(III) phosphate*,  $\text{CrPO}_4$ ,  $\rho$   $2.99$  g/cm<sup>3</sup>, is a black powder which belongs to the orthorhombic crystal system. It is insoluble in water, hydrochloric acid, and aqua regia but is attacked by boiling sulfuric acid. It is obtained by calcining its hydrates. The violet *hexahydrate*,  $[\text{Cr}(\text{H}_2\text{O})_6]\text{PO}_4$ ,  $\rho$   $2.12$  g/cm<sup>3</sup>, precipitates from chromium(III) salt solutions upon addition of phosphoric acid and disodium hydrogen phosphate. The crystals are triclinic and only sparingly soluble in water. Green chromium(III) phosphates precipitated hot contain two to three molecules of water after drying. A salt containing four molecules of water is also known. The green products are virtually insoluble in water. They are used to a small extent as pigments and have corrosion-inhibiting properties.

**Chromium lignosulfonates** are prepared by reaction of sulfite waste liquor from the pulp industry with sodium dichromate solution, the hexavalent chromium being reduced by the organic material to trivalent chromium. After filtration, the pH is adjusted by means of alkali and the product is dried in spray driers. It is a free-flowing, water-soluble powder and normally contains cations in the following quantities: ammonium 1.5–2.5%, chromium 2.5–4.2%, iron 0–5%, and sodium 1.5–2.5%. These saltlike compounds are used to a large extent in the petroleum industry as additives for lowering the viscosity of drilling muds and decreasing liquid loss [93].

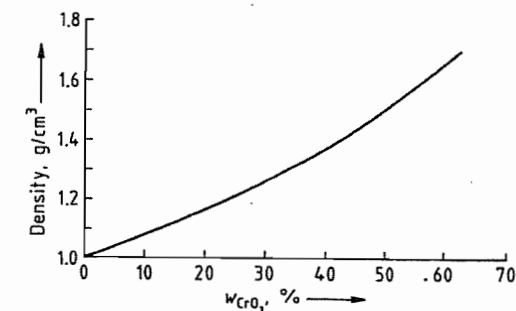

Figure 46.7: Density of aqueous chromic acid solutions at  $15.6^\circ\text{C}$ .

## 46.9.4 Chromic Acids and Chromates(VI)

### 46.9.4.1 Chromic Acids

Chromic acids are not known in the free state. Depending on the method of preparation, mono-, di-, tri-, or tetrachromic acids are formed in aqueous solution. In alkaline or dilute solution, formation of the yellow monochromate ion is favored, but in acid solution or at high concentrations, the orange-red dichromate ion is formed preferentially. Aqueous solutions of chromic acids are, therefore, yellow or red depending on their concentrations. Figure 46.7 shows the density as a function of concentration.

Dissociation constants (at  $25^\circ\text{C}$ ) are as follows:

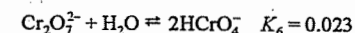
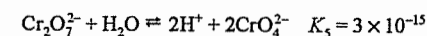
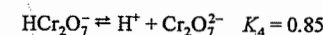
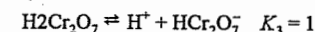
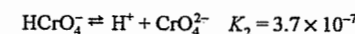
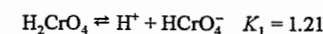

The standard redox potential for the reaction

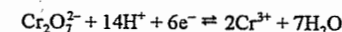

is 1.36 V.

Chromic acid solutions are strong oxidizing agents with a strongly acidic character, they form salts with metals and bases. The mono-

chromates(VI),  $M_2CrO_4$ , which are derived from chromic acid, hydrolyze in aqueous solution:

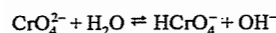

The easiest method of preparing chromic acid solutions is to dissolve chromium(VI) oxide in water. In industry, chromic acid is often produced from sodium dichromate(VI) and sulfuric acid.

Chromic acid solutions can also be prepared by anodic oxidation of chromium(III) sulfate solutions [94]; lead-lined cells with a diaphragm and lead electrodes are employed. To keep the concentration of sulfuric acid constant, the chromium(III) sulfate solution is introduced first into the cathode space, where it becomes depleted of sulfuric acid, and then into the anode space. Here, oxidation to chromic acid takes place and the concentration of sulfuric acid is restored to its original value.

In practice, several electrolytic cells are combined to form a unit. At a current density of 3 A/dm<sup>2</sup> the voltage is 3.5 V. Current efficiency is 80%. Lost chromium is periodically replenished by adding chromium(III) oxide. The electrolytic preparation of chromic acid can also start from chromium hydroxide hydrate with chromic acid as electrolyte [95].

Aqueous chromic acid solutions are used as pickling and chromium-plating baths in the metal processing and plastics processing industries.

#### 46.9.4.2 Alkali Chromates and Dichromates

**Sodium chromate**,  $Na_2CrO_4$ , *mp* 792 °C,  $\rho$  2.723 g/cm<sup>3</sup>,  $\Delta H_{298}^0$  -1329 kJ/mol, crystallizes in the orthorhombic system in small yellow needles or columns; transformation to the hexagonal form takes place at 413 °C. The bulk density of the powder is 0.7 g/cm<sup>3</sup>, that of the crystals is 1.67 g/cm<sup>3</sup>. For solubility, see Table 46.10. The compound is hygroscopic and forms several hydrates: below 19.5 °C the decahydrate; between 19.5 and 25.9 °C, the

hexahydrate; and between 25.9 and 62.8 °C, the tetrahydrate which undergoes transformation into anhydrous sodium chromate above 62.8 °C.

To prepare the salt, sodium dichromate solution is usually mixed with a stoichiometric amount of sodium hydroxide, and the salt solution is then crystallized or spray dried. The 96.5–98.5% product (0.4% NaCl, 2%  $Na_2SO_4$ ) is stored and dispatched in watertight steel drums.

Sodium chromate is used as a corrosion inhibitor in the petroleum industry and as a dyeing auxiliary in the textile industry.

**Sodium Dichromate.** The *dihydrate*,  $Na_2Cr_2O_7 \cdot 2H_2O$ ,  $\rho$  2.348 g/cm<sup>3</sup>,  $\Delta H_{298}^0$  -2194 kJ/mol, forms orange-red, monoclinic, translucent needles which are converted into the anhydrous salt above 84.6 °C. The bulk density is 1.2 g/cm<sup>3</sup>. For solubility, see Table 46.10. The heat of solution is -118 kJ/kg. The compound is very hygroscopic and deliquesces in air; in acid solution, it is a strong oxidizing agent.

Sodium dichromate is the most important of the industrial chromium chemicals and is used as the starting compound for almost all chromium compounds. Large quantities are used in numerous industrial fields. In the textile industry (wool, cotton, silk, and synthetics), sodium dichromate is used in mordanting and in after-treatment baths. The leather industry virtually no longer uses sodium dichromate. Sodium dichromate has a variety of uses in the surface treatment of metals, e.g., in the pickling of steel, aluminum, magnesium, and other metals and their alloys. The ability of the chromates to convert gelatin or protein into an insoluble form on exposure to light is exploited on a large scale in printing technology (lithography). A further field of application for the dichromates is in corrosion protection; they are added to crude oil in pipelines and to water in closed cooling systems as direct corrosion inhibitors. Sodium dichromate is also used for the manufacture of wood preservatives.

Table 46.10: Solubility (in %) of various chromates in water.

|                             | Temperature, °C |        |       |        |       |      |       |        |
|-----------------------------|-----------------|--------|-------|--------|-------|------|-------|--------|
|                             | 20              | 25     | 40    | 50     | 60    | 75   | 80    | 100    |
| Sodium chromate             |                 | 44.3   | 48.8  |        | 53.5  |      | 55.8  | 56.1   |
| Sodium dichromate dihydrate | 70.6            | 73.18  | 77.09 |        | 82.04 |      | 88.39 | 91.43  |
| Potassium chromate          |                 | 39.96  |       |        |       |      |       | 45.0   |
| Potassium dichromate        | 4.3             | 11.7   | 20.9  |        | 31.3  |      | 42.0  | 50.2   |
| Ammonium chromate           | 19.78           |        | 27.02 | 34.4   |       | 41.2 |       |        |
| Ammonium dichromate         | 15.16           | 26.67  | 36.99 |        | 46.14 |      | 54.10 | 60.89  |
| Silver chromate             |                 | 0.0025 |       | 0.0053 |       |      |       | 0.0041 |

In the chemical industry, sodium dichromate is used as a strong oxidizing agent in numerous cases; the most important include oxidation of anthracene to anthraquinone (dyes), of aniline to quinone (hydroquinone for the photographic industry), of camphene to camphor, and of contaminants in oils, fats, tallow, and waxes (soap industry, wax bleaching).

To these classical applications, the wide field of catalysts and catalyst carriers containing chromium(III) oxide or chromates has been added over the past thirty years. These are important in a variety of oxidation and carbonizing processes.

*Anhydrous sodium dichromate*,  $Na_2Cr_2O_7$ , *mp* 356.7 °C,  $\rho$  2.52 g/cm<sup>3</sup>, bulk density 1 g/cm<sup>3</sup>, heat of solution ca. -33.5 kJ/kg, forms light-brown to orange-red plates which are strongly hygroscopic. They decompose above 400 °C with the formation of sodium monochromate(VI), chromium(III) oxide, and oxygen.

Anhydrous sodium dichromate can be prepared by melting down sodium dichromate dihydrate, by crystallizing aqueous dichromate solutions above 86 °C, or by drying sodium dichromate solutions in spray driers.

Anhydrous sodium dichromate is required for cases in which the water content of the dihydrate has an interfering action. Thus, for example, the energy liberated in the oxidation with anhydrous sodium dichromate is greater than that liberated in the case of sodium dichromate dihydrate. Anhydrous sodium dichromate is, therefore, used in the preparation of chromium(III) oxide by the dry process, in pyrotechnics, and in anhydrous oxidation processes where it replaces the more

expensive potassium dichromate. Compared with sodium dichromate dihydrate, anhydrous sodium dichromate has the advantage that it can first absorb two molecules of water (13%) instead of deliquescing immediately when moisture is admitted.

**Potassium chromate**,  $K_2CrO_4$ , *mp* 968.3 °C,  $\rho$  2.73 g/cm<sup>3</sup>,  $\Delta H_{298}^0$  -1383 kJ/mol, occurs as the stable  $\beta$ -modification. The lemon-yellow, nonhygroscopic prisms are isostructural with  $K_2SO_4$ . At 666 °C they are converted into hexagonal  $\alpha$ -potassium chromate. For solubility, see Table 46.10. The heat of solution is -71.3 kJ/kg. The salt crystallizes from aqueous solution in anhydrous form and is thermally stable.

Potassium chromate is obtained by reacting potash with potassium dichromate. The potassium salt has been supplanted nearly completely by the cheaper sodium chromate and is used only for very specific purposes such as in the photographic industry.

**Potassium dichromate**,  $K_2Cr_2O_7$ , *mp* 397.5 °C, occurs in two modifications.  $\alpha$ - $K_2Cr_2O_7$ , tabular or prismatic, bright orange-red triclinic crystals,  $\rho$  2.676 g/cm<sup>3</sup>, has a bulk density of about 1.3–1.6 g/cm<sup>3</sup>; at 241.6 °C  $\alpha$ - $K_2Cr_2O_7$  transforms to  $\beta$ - $K_2Cr_2O_7$ . For solubility, see Table 46.10. The heat of solution is -258.3 kJ/kg. The thermodynamic data are as follows:  $c_p$  219.7 Jmol<sup>-1</sup>K<sup>-1</sup>,  $\Delta H_{298}^0$  -2033 kJ/mol,  $S_p^0$  291.2 Jmol<sup>-1</sup>K<sup>-1</sup>, heat of fusion 36.7 kJ/mol. The substance is not hygroscopic and, above the melting point, decomposes into potassium chromate, chromium oxides, and oxygen.

Today potassium dichromate is obtained primarily by conversion of sodium dichromate with potassium chloride. Potassium dichro-

mate has largely been supplanted by the cheaper sodium dichromate but is still used whenever its advantage of being nonhygroscopic is important, for example, in the match, firework, film, and photographic industries. Potassium dichromate is of interest in the preparation of yellow and green zinc pigments.

**Ammonium chromate**,  $(\text{NH}_4)_2\text{CrO}_4$ , smells of ammonia and forms golden yellow needles,  $\rho$  1.886 g/cm<sup>3</sup>,  $\Delta H_{298}^0$  -1152 kJ/mol,  $S_{298}^0$  656 Jmol<sup>-1</sup>K<sup>-1</sup>. For solubility, see Table 46.10. In air, it decomposes into ammonia, water, and ammonium dichromate. On heating it ignites and decomposes into chromium(III) oxide, ammonia, and nitrogen. Ammonium chromate is prepared from ammonium dichromate with the addition of ammonia.

**Ammonium dichromate**,  $(\text{NH}_4)_2\text{Cr}_2\text{O}_7$ , forms large, bright orange-red crystals,  $\rho$  2.155 g/cm<sup>3</sup>, bulk density ca. 1.0–1.3 g/cm<sup>3</sup>. For solubility, see Table 46.10. The heat of solution is -230.9 kJ/mol. Ammonium dichromate crystallizes in anhydrous form from aqueous solution and is not hygroscopic. Decomposition, which is not preceded by melting, sets in on heating to 180 °C; this becomes self-maintaining at 225 °C and above. Decomposition proceeds with displays of fire and heat, and large amounts of gas are developed. The products of decomposition are chromium(III) oxide, nitrogen, and water vapor. Ammonium dichromate reacts very violently with organic solvents.

Ammonium dichromate is prepared by reaction of sodium dichromate with ammonium chloride or, less frequently, ammonium sulfate. Ammonium dichromate is used as the starting material for preparing very finely divided chromium(III) oxide and, in addition, finds application primarily in pyrotechnics, wood preservation, and photography (lithography) for the preparation of light-sensitive solutions of gelatin or proteins. Ammonium dichromate is also used to prepare catalysts for organic syntheses. A further field of application is the production of magnetic chromium(IV) oxide. Because of its self-ignition

properties and explosiveness, ammonium dichromate is subject to the German Explosives Law and the IMDG code, class 5.1, UN No. 1439. It is also distributed moist.

#### 46.9.4.3 Other Chromates

**Barium chromate**,  $\text{BaCrO}_4$ ,  $mp$  1400 °C (decomp.),  $\rho$  4.498 g/cm<sup>3</sup>,  $\Delta H_{298}^0$  -1156 kJ/mol, crystallizes as light-yellow transparent rhombic crystals which are isomorphous with barium sulfate. Barium chromate is only sparingly soluble in water but dissolves readily in acids.

In the presence of excess alkali chromate or dichromate, barium chromate has a tendency to form double salts, among which special mention may be made of potassium barium chromate,  $\text{K}_2\text{CrO}_4 \cdot \text{BaCrO}_4$ , and ammonium barium chromate,  $(\text{NH}_4)_2\text{CrO}_4 \cdot \text{BaCrO}_4$ , both of which are light yellow.

These barium chromate double salts can be prepared by reaction of soluble barium salts or barium hydroxide with alkali chromate(VI) or dichromate(VI). In weakly acid solutions, as is the case, for example, if dichromates(VI) are used, the precipitation is incomplete. Quantitative precipitation is achieved by adding sodium acetate.

Yellow barium chromate and its double salts can be used for the production of chrome pigments for paints; the double salts, in particular, are excellent corrosion protection paints for all metals. They form sparingly soluble metal chromates, which prevent attack by moisture (condensation, seawater) even more readily than zinc chromate.

**Calcium chromate**,  $\text{CaCrO}_4$ ,  $mp$  1020 °C (decomp.),  $\rho$  3.12 g/cm<sup>3</sup>, is a yellow powder which is sparingly soluble in water (4.3% at 0 °C, 0.42% at 100 °C). The compound has acquired no industrial importance, but its preparation directly from chromium ores is described in several patents [96, 97].

**Calcium dichromate**,  $\text{CaCr}_2\text{O}_7$ ,  $\Delta H_{298}^0$  -1821 kJ/mol, is thought not to constitute a uniform crystalline phase but to be a mixture of phases consisting of calcium monochromate and

chromium(VI) oxide. The compound forms a series of readily soluble hydrates. Thus, below 10 °C, the hexahydrate  $\text{CaCr}_2\text{O}_7 \cdot 6\text{H}_2\text{O}$  exists; between 20 and 40 °C, the pentahydrate; between 50 and 60 °C, the tetrahydrate; and above 70 °C, the monohydrate. A red deliquescent calcium dichromate trihydrate has also been prepared from the tetrahydrate.

Calcium dichromate can be made industrially by oxidative roasting of chromium-containing ores with calcium carbonate or calcium oxide and subsequent leaching of the cake with an acid e.g., chromic or sulfuric acid [97].

**Copper Chromates.** Neutral copper chromate,  $\text{CuCrO}_4$ , is produced as a yellowish brown, water-containing compound by precipitation from a copper sulfate solution with sodium or potassium dichromate. The compound is used as the starting material for "chrome black" which is prepared by calcining the neutral salt under oxidizing conditions and subsequently leaching with hydrochloric acid.

The double salt *copper ammonium chromate* (cupric ammonium chromate) is required in dyeworks along with logwood and fustic extracts to obtain olive green wool or cotton dyes. Copper chromate is used as such or in reduced form as a catalyst in a number of petrochemical reactions.

**Iron Chromates.** No anhydrous iron(II) chromate is known. On the other hand, the water-soluble double salts,  $\text{KFe}^{\text{III}}(\text{CrO}_4)_2 \cdot 2\text{H}_2\text{O}$  and  $\text{NH}_4\text{Fe}^{\text{III}}(\text{CrO}_4)_2 \cdot 2\text{H}_2\text{O}$  do exist, and potassium iron(III) chromate is a corrosion inhibitor. A similar corrosion-inhibiting compound is also thought to be formed on steel surfaces that are treated with chromate solutions. Industrially, the compound is produced by the reaction of iron(III) chloride solution with potassium dichromate in an autoclave at 130–160 °C. The precipitate is filtered and dried.

**Lead chromate**,  $\text{PbCrO}_4$ ,  $mp$  844 °C (with evolution of oxygen),  $\rho$  6.123 g/cm<sup>3</sup>,  $\Delta H_{298}^0$

-910 kJ/mol, is a yellowish orange powder which occurs in three modifications:

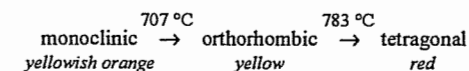

The solubility product in water is  $1.5 \times 10^{-14}$  at 18 °C. Lead chromate forms mixed crystals with lead(II) oxide, lead sulfate, and lead molybdate. All these salts are virtually insoluble in water; the molybdenum-containing compound is particularly well-known as molybdenum red. Lead chromate is prepared in a manner similar to that used for barium chromate. The composition, color, and quality of lead chromates depend on the conditions of precipitation; they are used widely as yellow to red pigments in the lacquer and paint industry.

**Silver Chromate and Silver Dichromate.**  $\text{Ag}_2\text{CrO}_4$ ,  $\rho$  5.625 g/cm<sup>3</sup>,  $\Delta H_{298}^0$  -711.7 kJ/mol,  $S_{298}^0$  216 Jmol<sup>-1</sup>K<sup>-1</sup>,  $c_p$  142.3 Jmol<sup>-1</sup>K<sup>-1</sup>, and  $\text{Ag}_2\text{Cr}_2\text{O}_7$ ,  $\rho$  4.770 g/cm<sup>3</sup>,  $\Delta H_{298}^0$  -1218 kJ/mol, form dark red crystals and are soluble in acids, ammonia, and potassium cyanide solutions but not in water. The salts can be precipitated from a silver salt solution with chromate or dichromate solution and are used in the photographic industry.

**Zinc chromate**,  $\text{ZnCrO}_4$ , is sparingly soluble in water but dissolves readily in acids. A series of zinc chromate hydrates exists having the composition  $n\text{ZnO} \cdot m\text{CrO}_3 \cdot x\text{H}_2\text{O}$ . In industry zinc chromate is known as zinc yellow. Its color may be controlled by the mode of preparation. It is made by the reaction of either a suspension of finely ground zinc white (ZnO) in concentrated sulfuric acid or water-soluble zinc salts ( $\text{ZnCl}_2$ ,  $\text{ZnSO}_4$ ) with potassium or ammonium dichromate. The zinc chromates prepared in this manner always incorporate potassium or ammonium ions into their lattice. Zinc chromate is used in lacquer primers as a corrosion inhibitor instead of minium (red lead) because of its ability to form insoluble iron(III) chromates with iron or to passivate metal surfaces by oxidation.

## 46.9.5 Other Chromium Compounds

**Chromyl chloride**,  $\text{CrO}_2\text{Cl}_2$ ,  $mp -96.5^\circ\text{C}$ ,  $bp 116.7^\circ\text{C}$ ,  $\rho 1.912\text{ g/cm}^3$ , is a blood red oily liquid with a pungent smell,  $c_p 545\text{ Jkg}^{-1}\text{K}^{-1}$ ,  $\Delta H_{298}^0 -567.8\text{ kJ/mol}$ ,  $S_{298}^0 510\text{ Jkg}^{-1}\text{K}^{-1}$ , heat of fusion  $268\text{ kJ/kg}$ . In the temperature range  $178\text{--}390\text{ K}$  the vapor pressure obeys the equation

$$\log p = -3340T^{-1} - 9.08\log T + 35.06$$

where  $p$  is in hPa (mbar) and  $T$  in K. The liquid is electrically conducting.

Chromyl chloride is easily hydrolyzed; it is an extremely powerful oxidizing and chlorinating agent and, therefore, reacts with organic solvents, often violently. It decomposes in daylight within a week via  $\text{CrO}_2$  and  $\text{Cl}_2$  to form a series of chromium oxides and chlorides with a low degree of oxidation.

Industrially chromyl chloride is produced from chromium(VI) oxide and hydrogen chloride gas, with concentrated sulfuric acid (> 68%) being used primarily to bind the water of reaction. The higher density chromyl chloride is drained, distilled, and collected in cooled receptacles.

Chromyl chloride can also be prepared by using mixtures or molten baths of sodium chloride and alkali chromates or dichromates with fuming sulfuric acid. An elegant route involves the reaction of chromium(VI) oxide with liquid thionyl chloride; these reactants are converted quantitatively into chromyl chloride by elimination of  $\text{SO}_2$ .

**Hexacarbonylchromium**, chromium hexacarbonyl,  $\text{Cr}(\text{CO})_6$ ,  $\rho 1.77\text{ g/cm}^3$ , forms colorless, highly refractive crystals which belong to the orthorhombic system. The compound sublimes slowly even at room temperature; when heated in a sealed tube it melts at  $149\text{--}150^\circ\text{C}$ . The boiling point has been calculated to be  $147^\circ\text{C}$ . At  $210^\circ\text{C}$ , explosive decomposition occurs. The enthalpy of formation is  $-1077\text{ kJ/mol}$ . Hexacarbonylchromium is somewhat soluble in chloroform and carbon tetrachloride but insoluble in benzene, ether, alcohol, and acetic acid. It is resistant to water and dilute

acids at room temperature; there is no sign of attack even by concentrated hydrochloric acid or sulfuric acid in the cold, but concentrated nitric acid causes decomposition. No reaction with alkali occurs, but derivatives are produced with ammonia, pyridine, cyclopentadiene, and other organic ligands.

Attempts to synthesize hexacarbonylchromium directly from chromium and carbon monoxide have been unsuccessful. The action of carbon monoxide and a solution of phenylmagnesium bromide in ether on anhydrous chromium(III) chloride suspended in a mixture of benzene and ether produces intermediates that lead to hexacarbonylchromium upon addition of acid and distilling the ether in vacuo. Finely divided sodium can also be used for reduction instead of phenylmagnesium bromide. Yields of up to 80% are reported when very finely divided sodium reacts with anhydrous chromium(III) chloride below  $0^\circ\text{C}$  with carbon monoxide at a pressure of about 6 MPa (60 bar); the reaction proceeds in the presence of diethylene glycol dimethyl ether; the mixture is subsequently hydrolyzed while the carbon monoxide pressure is maintained [98].

Applications quoted for hexacarbonylchromium include the tempering and hardening of metal surfaces by chromizing, use as a fuel additive, an intermediate in the preparation of organic chromium compounds, and a catalyst for oxo syntheses.

**Chromium(II) Compounds.** In general, compounds of divalent chromium are extremely unstable in air and, therefore, are of only minor importance in industry. Gaseous chromium(II) halides (for preparation, see [99]) are used to produce chromium diffusion layers on iron and nickel parts. Air stable sodium fluorochromate(II) is said to be suitable for the precipitation of metals in electroplating operations and for corrosion-protection coatings [100].

## 46.9.6 Analysis

Compounds that are insoluble in water and acids, for example, chromium ore, are solubi-

lized by roasting with sodium peroxide [101] in the presence of soda. Chrome-tanned leathers are incinerated before being treated with sodium peroxide. Under these conditions, chromium is completely converted into water-soluble chromate(VI). The roasted mass is leached with hot water and after cooling sulfuric acid is added. Compounds of lower oxidation state that are soluble in water or acids are oxidized with ammonium persulfate to chromate(VI) in dilute boiling sulfuric acid in the presence of silver ions as catalysts [102]. Chloride ions must be removed beforehand. Traces of chloride ions are precipitated by adding a few drops of silver nitrate solution. The chromate(VI) solutions obtained in this way or solutions of chromium(VI) compounds that are soluble in water or sulfuric acid, are then titrated with iron(II) sulfate solution after phosphoric acid is added [103]. The end point of this titration can be determined potentiometrically or by means of a redox indicator, e.g., sodium diphenylamine-4-sulfonate [103]. Iodometric titration of chromate(VI) is also possible [104]. For very low concentrations, e.g., in the analysis of water, atomic absorption spectrometry (AAS) and, in recent years, inductively coupled plasma atomic emission spectrometry (ICP-AES) have proved successful [106]. Trace amounts of chromium are also detected photometrically at 540 nm after oxidation to chromate(VI) and addition of diphenylcarbazide (formation of a reddish violet complex) [105].

## 46.9.7 Transportation, Storage, and Handling

The toxicity and the effects on the environment of chromium compounds are largely determined by the valency in which the chromium is present. Only tri- and hexavalent chromium compounds, and chromium(IV) oxide,  $\text{CrO}_2$ , are of economic importance. Only chromium(VI) compounds are classified as dangerous in regulations relating to chemicals and transportation [107]. According to the IMDG code, the following classifications are applicable for transportation [108]:

$\text{Na}_2\text{Cr}_2\text{O}_7$ ,  $\text{K}_2\text{Cr}_2\text{O}_7$ : hazard class 6.1, UN No. 2811;  $(\text{NH}_4)_2\text{Cr}_2\text{O}_7$ : hazard class 5.1, UN No. 1439;  $\text{CrO}_3$  (solid chromic acid): hazard class 5.1, UN No. 1463; chromic acid, solution: hazard class 8, UN No. 1755.

During handling and storage, chromates, dichromates, and chromic acid must not be brought into contact with readily oxidizable substances. The possible hazard to water supplies from chromium(VI) chemicals should also be borne in mind [109].

Throughout the world, the limit of  $50\text{ }\mu\text{g/L}$  of chromium recommended by the WHO has been adopted in drinking water regulations. This figure was estimated by the U.S. Public Health Service from the toxicity data, the "No Observable Adverse Effect Level" (NOAEL), and the calculated "average daily intake" (ADI) for  $\text{K}_2\text{Cr}_2\text{O}_7$  [110].

## 46.9.8 Environmental Protection

The following limits are specified in some regulations in Germany [111] and in Japan for the introduction of wastewater into sewage treatment plants: total chromium  $2\text{ mg/L max.}$ , chromium(VI)  $0.5\text{ mg/L max.}$

In Germany, the emission of such carcinogenic chromates as calcium chromate, strontium chromate, chromium(III) chromate, and zinc chromate is limited to  $1\text{ mg/m}^3\text{ max.}$  (specified as chromium) [112]; the emission of the other chromium compounds is limited to  $5\text{ mg/m}^3$  (specified as Cr).

Within the European Community, refuse that contains chromium(VI) compounds is considered hazardous [113]. In Germany, sewage sludge containing up to 1200 mg per kilogram of chromium may be applied to soil used for agricultural purposes provided the chromium content of the soil does not exceed  $100\text{ mg/kg}$  before the application [114]. According to the U.S. Environmental Protection Agency, the chromium content of the soil should not be regarded as a limiting factor for the application of sewage sludge [115]. According to recent studies no harmful effect is to be expected from chromium ions when sewage sludge containing chromium hydroxide is applied to the

soil even if the level presently permitted is exceeded by a factor of 1000 [116].

### 46.9.9 Ecotoxicology

Insoluble inert chromium(III) oxide,  $\text{Cr}_2\text{O}_3$ , is the stable mineral end product into which chromium compounds are converted in the environment as a result of natural processes.

**Inland Waters.** The mean concentration of chromium in surface waters is  $< 1\text{--}10 \mu\text{g/L}$  [117–119]. If trivalent chromium gets into an inland body of water it precipitates as chromium hydroxide in neutral regions. This ages

and becomes increasingly insoluble, with only a small proportion remaining in solution. If chromium(VI) compounds get into inland waters, they are reduced to chromium(III) compounds by the natural content of organic substances.

Table 46.11 summarizes toxicity data for chromium(III) and chromium(VI) compounds in relation to fish, bacteria, algae, daphnia, and plants.

The "water quality criteria documents" in the U.S. Federal Register [133], for example, specify limits for metals in freshwater (Table 46.12).

**Table 46.11:** Ecotoxicology of chromium compounds.

| Species or medium                                     | Chromium(III) compounds  | Chromium(VI) compounds  |
|---|--|---|
| Freshwater fish                                       | $\text{CrCl}_3$ :<br>LC <sub>50</sub> (48 h) minnows, static, 400 mg/L<br>LC <sub>50</sub> (48 h) trout, static, > 1000 mg/L [120]<br>LC <sub>50</sub> (48 h) ides, static, 300 mg/L | $\text{K}_2\text{Cr}_2\text{O}_7$ :<br>14 day no observable effect level (NOEL) for zebra fish ( <i>Brachydanio rerio</i> ) at 50 mg/L [127] or 80 mg/L [128]   |
| Bacteria  | $\text{KCr}(\text{SO}_4)_2 \cdot 12\text{H}_2\text{O}$ :<br>100 mg/L proved not to be poisonous for bacteria of the genus <i>Escherichia</i> [121]                                   | $\text{Na}_2\text{Cr}_2\text{O}_7 \cdot 2\text{H}_2\text{O}$ :<br>toxic limiting concentration for <i>Pseudomonas putida</i> 0.78 mg/L [129]  |
| Algae   | $\text{KCr}(\text{SO}_4)_2 \cdot 12\text{H}_2\text{O}$ :<br>incipient injurious effect at 4–6 mg/L ( <i>Scenedesmus</i> ) [121]  | $\text{K}_2\text{Cr}_2\text{O}_7$ ( <i>Scenedesmus subspicatus</i> ):<br>EC <sub>10</sub> (96 h) 0.5 mg/L [127]; 0.3–1.3 mg/L [130]; 1.8 mg/L [128]<br>EC <sub>50</sub> (96 h) 1.4 mg/L [127]; 1.6–4.7 mg/L [130]   |
| Daphnia   | $\text{KCr}(\text{SO}_4)_2 \cdot 12\text{H}_2\text{O}$ :<br>marked injurious effect at 42 mg/L [121]   | $\text{K}_2\text{Cr}_2\text{O}_7$ (21-day test):<br>concentrations of > 0.1 mg/L markedly decreased the production of offspring [128]; swimming ability of <i>Daphnia magna</i> : EC <sub>0</sub> = 0.3 mg/L; EC <sub>50</sub> = 0.9 mg/L; EC <sub>100</sub> = 2.2 mg/L [131] |
| Mammals (oral, rat)                                   | $\text{Cr}(\text{NO}_3)_3$ :<br>LD <sub>50</sub> 3250 mg/kg [122]  | $\text{Na}_2\text{Cr}_2\text{O}_7 \cdot 2\text{H}_2\text{O}$ :<br>LD <sub>50</sub> 150 mg/kg [132]  |
| Soil mobility   | low, only certain complex compounds are biologically available [123]   | $\text{K}_2\text{Cr}_2\text{O}_7$ :<br>low since chromate is strongly adsorbed on the spodosol type of soil [128, 130] and is also reduced by organic soil constituents   |
| Bioaccumulation                                       | plants, particularly the parts above ground, do not absorb much chromium; accumulation of Cr is prevented at the very beginning of the food chain [124, 125]                         | $\text{K}_2\text{Cr}_2\text{O}_7$ :<br>carp ( <i>Cyprinus carpio</i> ): no bioaccumulation detected [128]   |
| Higher plants<br>EC <sub>50</sub> <sup>a</sup> (14 d) | $\text{CrCl}_3 \cdot 6\text{H}_2\text{O}$ :<br><i>Avena sativa</i> (oat) 560 mg of Cr/kg of soil [126]<br><i>Brassica rapa</i> (turnip) 230 mg of Cr/kg of soil [126]                | $\text{K}_2\text{Cr}_2\text{O}_7$ :<br>oat: 27 mg/kg [127]; 32 mg/kg [128]; 96 mg/kg [130]<br>turnip: 23 mg/kg [127]; 22 mg/kg [128]; 24 mg/kg [130]  |
| Earthworm<br>LC <sub>50</sub> (28 d)                  | not known  | $\text{K}_2\text{Cr}_2\text{O}_7$ :<br>> 2000 mg/kg of soil [127]<br>no lethal effects at 1000 mg/kg [130]  |

<sup>a</sup>EC = effective concentration; at EC<sub>50</sub> growth is retarded by 50% compared with control.

**Table 46.12:** Limits for chromium and copper (for comparison) in freshwater,  $\mu\text{g/L}$  [133].

| Oxidation state | Water hardness, $\text{CaCO}_3$ , mg/L |      |      |
|-----------------|--|------|------|
|                 | 50                                     | 100  | 200  |
| Cr(III)         | 2200                                   | 4700 | 9900 |
| Cr(VI)          | 21                                     |      |      |
| Cu(II)          | 12                                     | 22   | 43   |

**Soil.** The chromium content of soil varies very widely depending on the geological conditions. The range is from 5 to 1500 mg/kg, and the average level is about 50 mg/kg [134]. Chromium is found everywhere in the soil of Germany [135], and levels of over 1100 mg/kg may be reached. Such levels are caused solely by geological conditions.

**Plants.** Chromium occurs in soil in the form of chromium(III) compounds which are available to plants only to a small extent; consequently, chromium is not enriched in the food chain [124, 125, 136–138].

**Animals.** Grazing animals are not subjected unduly to chromium since only small amounts get into the parts of plants above the ground [131]. Less than 1% of the chromium contained in plants is available to animal and human organisms. To cover essential needs, the chromium must be in a special, biologically suitable form [139].

### 46.9.10 Economic Aspects [140–143]

The output of chromium ore is subject to considerable variations. Rich ores which are obtained easily by handpicking have declined. This shrinkage in output has to be counterbalanced by exploiting low-grade ores and upgrading them to saleable concentrates. The statistical documents are incomplete and contradictory.

Even the most pessimistic estimates of the worldwide reserves and the extraction possibilities in individual countries do not predict a chromium shortage before the end of this century. In addition, the huge lean-ore deposits in South Africa, Southeast Asia, and the United States, which are still completely untouched,

afford a replacement for the rich ores being mined at present.

In Table 46.13 the consumption of chromium ore is broken down according to products. The refractory brick share is declining because Siemens–Martin steel is being increasingly supplanted by oxygen-blown steel produced in converters with a basic lining.

Table 46.14 shows the share of individual applications in the consumption of chromium chemicals.

The starting material for virtually all chromium chemicals is sodium dichromate prepared from chromium ore.

**Table 46.13:** Estimated consumption of chromium ore in terms of products in 1984 [141, 144].

| Product   | World | United States |
|---|-------|---------------|
| Ferrochromium, FeSi chromium, chromium metal, and foundry sands | 72%   | 60%           |
| Refractory bricks   | 12%   | 20%           |
| Chemicals   | 17%   | 20%           |

**Table 46.14:** Estimated share (in %) of individual applications in the consumption of chromium chemicals, 1985 (excluding countries with state trading organizations).

|                      | United States | Worldwide |
|----------------------|---------------|-----------|
| Pigments             | 22            | 19        |
| Metal processing     | 15            | 24        |
| Tanning              | 12            | 32        |
| Wood preservation    | 26            | 11        |
| Corrosion protection | 5             | 3         |
| Petroleum industry   | 5             | 2         |
| Textile dyes         | 2             | 1         |
| Catalysts            | 2             | 1         |
| Video tapes          | 2             | 2         |
| Remainder            | 9             | 5         |

### 46.9.11 Toxicology and Occupational Health

Only the hexavalent chromium compounds are biologically active. Metallic chromium and the trivalent compounds, including those in chromium ores, are neither irritating, mutagenic, nor carcinogenic [145]. Sporadic incidences of skin sensitization supposedly caused by chromium(III) were probably caused by traces of chromium(VI) present.

**Human Nutrition.** Chromium is an essential trace element. The antidiabetogenic factor, a chromium-containing protein compound, is an example of a cofactor for the effect of insulin [146]. Some metabolic processes in animals and humans cannot proceed normally in the event of a chromium deficiency [147–149].

Most foodstuffs in the United States and Germany contain less than 0.1 mg of chromium per kilogram of fresh weight. Excessive levels of chromium in vegetable and animal food are unknown. On the contrary, the supply of chromium as an essential trace element tends to be too low rather than too high in Western industrial countries [150, 151]. The U.S. Food Nutrition Board recommends a daily intake of 50–500 µg for adults [152].

For chromium the gap between essential and toxic concentrations is particularly large. Mammals can tolerate 100 to 200 times the normal chromium content of their bodies without injury [153].

**Chromium Dioxide.** In a single administration, chromium dioxide is resorptively non-toxic; the lethal dose is greater than 17 000 mg/kg (rats, oral). In rabbits, chromium dioxide causes slight primary irritation of skin and mucous membranes.

Since any chromium dioxide in the normal atmosphere always contains traces of hexavalent chromium, care is taken during production and further processing to ensure that the concentration of chromium dioxide at the workplace does not exceed 0.08 mg/m<sup>3</sup>, which is approximately equivalent to the MAK of CrO<sub>3</sub> of 0.1 mg/m<sup>3</sup>. At higher concentrations breathing masks should be worn, for example, grade 2b (DIN 3180).

Employees of chromium dioxide plants are examined annually for chromium contamination. So far no indications have been found of any disease caused by chromium in chromium dioxide production plants.

**Hexavalent Chromium Compounds.** Particularly chromic acid and the alkali chromates corrode and irritate the skin and mucous membranes.

**Acute Effects.** Effects of longer exposure to hexavalent chromium compounds vary from irritation of the nasal mucous membrane to the formation of ulcers and perforations of the nasal septum [154].

Higher concentrations irritate the bronchial mucous membrane, thereby leading to bronchitis. Penetration of hexavalent chromium particles into small skin defects — not uninjured skin — causes ulcers which heal badly. Uptake by the digestive system (mostly in suicidal cases) causes serious intestinal inflammation, sometimes with loss of blood. Damage to the renal tubules occurs mainly after dermal absorption. This can lead to kidney failure if the spontaneous reduction capacity of plasma of about 2 ppm (20 minutes) is not sufficient to reduce chromium(VI) to the non-toxic chromium(III). The administration of high doses of ascorbic acid facilitates this reduction, and chromium(III) is then excreted in the urine without causing kidney damage [155].

**Chronic Effects.** Chronic irritation of the nasal mucous membrane can lead to its atrophy. Chronic bronchitis has been reported following long-term exposure to hexavalent chromium compounds, but this does not occur normally under today's manufacturing conditions [145]. Impairment of breathing has not been observed.

Hexavalent chromium compounds are capable of sensitizing the skin strongly, which may lead to chronic eczemas, particularly when the source is cement dust containing chromium(VI). In contrast, no sensitization of the respiratory tract occurs.

**Mutagenicity.** All hexavalent chromium compounds are mutagenic, but trivalent chromium compounds do not have any mutagenic potential. In some cases, the hexavalent compounds must first be solubilized to show a mutagenic effect. This effect is counteracted by the reduction of chromium(VI) to chromium(III), for example, by adding body fluids or organ homogenates [156, 157].

**Carcinogenicity.** Many animal experiments have been carried out to test the carcinogenicity of chromium compounds. These

include subcutaneous injection, inhalation, intratracheal instillation, and introduction of pellets into the bronchial tree [158–161].

According to these experiments the hexavalent compounds of chromium with calcium, strontium, zinc, and chromium(III) (chromic chromate) must be categorized as carcinogenic. Sodium dichromate showed a weak carcinogenic effect only upon intratracheal instillation of doses near to the toxic limits [162]. Lead chromate, chromic acid, and alkali chromates and dichromates are not carcinogenic. Generally, the easily water-soluble as well as the insoluble hexavalent chromium compounds are considered noncarcinogenic, whereas the slightly soluble compounds are carcinogenic [161].

**Epidemiology.** Trivalent chromium compounds have proved to be noncarcinogenic [163].

Earliest indications of increased incidences of lung cancer among workers in the chromate manufacturing industry were observed in the 1930s. More evidence in support of this observation came from a large number of epidemiological studies done after 1948 [164, 165]. Studies carried out between 1948 and 1956 showed a 25- to 29-fold increase in the incidence of lung cancer. In contrast, investigations carried out since 1979 reflect the effects of improved hygienic working conditions and production processes, for example, by avoiding the use of lime in the oxidative roast of chromium ores (low-lime process). These measures have led to a convergence between the observed and the expected incidences of lung cancer [154, [166–169].

An increased incidence of lung cancer was observed among persons employed in the chromate pigment industry only after exposure to zinc chromate. Lead chromate, on the other hand, showed no carcinogenic effect [170–172]. Results of epidemiological studies carried out during the handling of chromic acid, particularly during chromium plating, are blurred by confounding factors; a statistically significant increase in the rate of lung cancer was not observed [158, 173]. An in-

creased risk of lung cancer has also not been clearly established in the manufacture of ferrochromium [174, 175]. Occupational health care has been provided in the chromate-producing industry for several decades.

**Classification.** Germany: MAK list, appendix III, class A1: zinc chromate; class A2: calcium chromate, chromium(III) chromate, strontium chromate; class B: alkali chromates, chromium trioxide. The TRK value of calcium, chromium(III), strontium, and zinc chromate is 0.1 mg/m<sup>3</sup> (as CrO<sub>3</sub> in total dust). For chromium trioxide, the MAK of 0.1 mg/m<sup>3</sup> (as CrO<sub>3</sub>) has been established.

**United States:** According to NIOSH [161], the following chromates are classified as noncarcinogenic: mono- and dichromates of hydrogen, lithium, potassium, sodium, rubidium, cesium, and ammonium, as well as chromic acid anhydride. All other hexavalent chromium compounds are classified as carcinogenic.

The threshold limit value (TLV) is as follows: chromium(VI) compounds 50 µg/m<sup>3</sup> (TWA; as chromium); chromium (metal), chromium(II), and chromium(III) compounds 500 µg/m<sup>3</sup> (TWA; as chromium).

**Biological Monitoring.** In addition to the classical assay for chromium in blood or urine, the degree of previous exposure to chromium can be estimated by determining the extent of bound chromium in erythrocytes [176].

## 46.10 Pigments

### 46.10.1 Chromium Oxide Pigments

Chromium oxide pigments, also called chromium oxide green pigments, consist of chromium(III) oxide, Cr<sub>2</sub>O<sub>3</sub>. Chromium oxide green is one of the few single-component pigments with green coloration. Chrome green is a blend of chrome yellow and iron blue pigments; phthalochrome green is a blend of chrome yellow and blue phthalocyanine pigments.



Natural, minable deposits of chromium oxide are not known. In addition to pigment grade, chromium oxide producers usually also offer a technical grade for applications based on properties other than coloration. These include:

- Metallurgy: aluminothermic production of chromium metal
- Refractory industry: production of thermally and chemically resistant bricks and lining materials
- Ceramic industry: coloring of porcelain enamels, ceramic frits, and glazes
- Pigment industry: raw material for the production of chromium-containing stains and pigments based on mixed metal oxide phases
- Grinding and polishing agent: chromium(III) oxide is used in brake linings and polishing agents due to its high hardness

Chromium oxide hydroxide and hydrated chromium oxide pigments (Grignets Green) have a very attractive blue-green color. They are of low opacity, but provide excellent light-fastness and good chemical resistance. Loss of water on heating limits the application temperature. These pigments are no longer of industrial importance [177].

#### 46.10.1.1 Properties

Chromium(III) oxide crystallizes in the rhombohedral structure of the corundum type; space group  $D_{3d}^6-R\bar{3}c$ ,  $\rho$  5.2 g/cm<sup>3</sup>. Because of its high hardness (ca. 9 on the Mohs scale) the abrasive properties of the pigment must be taken into account in certain applications [178]. It melts at 2435 °C but starts to evaporate at 2000 °C. Depending on the manufacturing conditions, the particle sizes of chromium oxide pigments are in the range 0.1–3  $\mu\text{m}$  with mean values of 0.3–0.6  $\mu\text{m}$ . Most of the particles are isometric. Coarser chromium oxides are produced for special applications, e.g., for applications in the refractory area.

Chromium oxide has a refractive index of ca. 2.5. Chromium oxide green pigments have

an olive green tint. Lighter greens with yellowish hues are obtained with finely divided pigments, and darker, bluish tints with larger particle diameters; the darker pigments are weaker colorants. The maximum of the reflectance curve lies in the green region of the spectrum at ca. 535 nm (Figure 46.8, curve a). A weaker maximum in the violet region (ca. 410 nm) is caused by Cr–Cr interactions in the crystal lattice. Chromium oxide green pigments are used in IR-reflecting camouflage coatings because of their relatively high reflectance in the near infrared (Figure 46.8, curve b).

Since chromium(III) oxide is virtually inert, chromium oxide green pigments are remarkably stable. They are insoluble in water, acid, and alkali and are thus extremely stable to sulfur dioxide and in concrete. They are light-, weather-, and temperature-resistant. A change of the tint only occurs above 1000 °C due to particle growth.

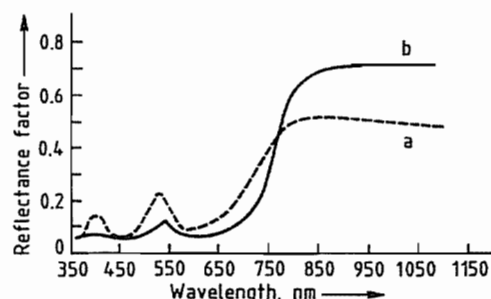

Figure 46.8: Dependence of the reflectance of chromium oxide on the wavelength: a) Regular pigment; b) Special product with larger particle size and high IR reflectance.

#### 46.10.1.2 Production

Alkali dichromates are used as starting materials for the production of chromium(III) oxide pigments. They are available as bulk industrial products in the required purity. High impurity levels have an unfavorable effect on the hue.

**Reduction of Alkali Dichromates.** In industrial processes, solid alkali dichromates are reacted with reducing agents such as sulfur or carbon compounds. The reaction is strongly

exothermic, and with sulfur proceeds as follows:

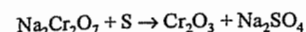

Sodium sulfate can then easily be separated by washing, because it is water soluble. The use of sulfur was first described in 1820 [179]. Roth described the use of  $\text{K}_2\text{Cr}_2\text{O}_7$  in 1927 [180]. If charcoal is used in place of sulfur,  $\text{Na}_2\text{CO}_3$  is formed as by-product [181].

Finely divided sodium dichromate (dihydrate or anhydrous) is mixed homogeneously with sulfur. This mixture is then reacted in a furnace lined with refractory bricks at 750–900 °C. An excess of sulfur is used to ensure completion of the reaction. The reaction mass is leached with water to remove water-soluble components such as sodium sulfate. The solid residue is then separated, dried, and ground.

If potassium dichromate is used instead of sodium dichromate, a green pigment with a more bluish hue is obtained.

If it is to be used as a pigment in paints and lacquers, chromium oxide green can be subjected to jet milling (micronization) to obtain the required properties (e.g., gloss).

**Reduction of Ammonium Dichromate.** Chromium(III) oxide can be obtained by thermal decomposition of ammonium dichromate. Above ca. 200 °C, a highly voluminous product is formed with elimination of nitrogen [182]. The pigment is obtained after addition of alkali salts (e.g., sodium sulfate) and subsequent calcination [183]. In the industrial process, a mixture of ammonium sulfate or chloride and sodium dichromate is calcined [184]:

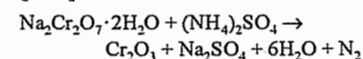

The workup is then carried out as described above. A chromium oxide pigment obtained by this process typically contains (%):

|                         |             |
|-------------------------|-------------|
| $\text{Cr}_2\text{O}_3$ | 99.0–99.5   |
| $\text{SiO}_2$          | 0.05 (max.) |
| $\text{Al}_2\text{O}_3$ | 0.1 (max.)  |
| $\text{Fe}_2\text{O}_3$ | 0.05 (max.) |
| S                       | ca. 0.02    |
| Water                   | ca. 0.3     |

Chromium oxides with a minimal sulfur content are preferred for metallurgical appli-

cations. These are obtained by reacting sodium dichromate with ammonium chloride or sulfate in a deficiency of 10 mol% [185]. Chromium(III) oxides with a low sulfur content can also be obtained by thermal aftertreatment [186]. Thermal decomposition of chromic acid anhydride ( $\text{CrO}_3$ ) yields high-purity chromium(III) oxide [187].

The pigment properties of chromium oxides can be modified by precipitation of hydroxides (e.g., of titanium or aluminum), and subsequent calcining. This treatment changes the color to yellow-green, and decreases the flocculation tendency [188]. Aftertreatment with organic compounds (e.g., alkoxyated alkylsulfonamides) is also used [189].

**Other Processes.** Other production processes are suggested in the patent literature, but have not so far gained industrial importance. For instance, sodium dichromate can be mixed with heating oil and reacted at 300 °C. The soda formed must be washed out prior to calcining at 800 °C to avoid reoxidation in the alkaline melt [190].

In alkaline solution, sodium chromate can be reduced with sulfur at atmospheric pressure with formation of sodium thiosulfate. After neutralization, more sodium chromate is added to exhaust the reducing capacity of the thiosulfate. The mixture is calcined at 900–1070 °C [191].

Another process involves the shock heating of sodium dichromate in a flame at 900–1600 °C in the presence of excess hydrogen and chlorine to bind the alkali as sodium chloride [192]. This method is suitable for the preparation of pigment-grade chromium oxide of high purity, with an especially low sulfur content.

**Environmental Protection.** Since alkali dichromates or chromic acid anhydride are used as starting materials for the production of chromium(III) oxides, occupational health requirements for the handling of hexavalent chromium compounds must be observed [193]. The sulfur dioxide formed on reduction with excess sulfur must be removed from the

flue gases according to national regulations, e.g., by oxidation to  $\text{H}_2\text{SO}_4$ .

Process wastewater may contain small amounts of unreacted chromates; recovery is uneconomical. Prior to release into drainage systems, the chromates in these wastewater streams must be reduced (e.g., with  $\text{SO}_2$  or  $\text{NaHSO}_3$ ) and precipitated as chromium hydroxide [194]. In Germany, for example, the minimum requirements for wastewater in the production of chromium oxide pigments are specified in [195].

### 46.10.1.3 Quality Specifications and Analysis

International, technical specifications for chromium oxide pigments are defined in ISO 4621 (1986), they must have a minimum  $\text{Cr}_2\text{O}_3$  content of 96%.

Various grades are defined according to their particle fineness as measured by the residue on a 45- $\mu\text{m}$  sieve: grade 1, 0.01% residue (max.); grade 2, 0.1% (max.); and grade 3, 0.5% (max.).

ISO 4621 (1986) also specifies analytical methods. Usually, analysis of chromium and the by-products is preceded by melting with soda and sodium peroxide. The content of water-soluble or acid-soluble chromium is becoming important from the toxicological and ecological point of view. It is determined according to DIN 53780 with water, or according to ISO 385615 with 0.1 mol/L hydrochloric acid.

### 46.10.1.4 Storage and Transportation

Chromium(III) oxide pigments are thermally stable and insoluble in water. They are not classified as hazardous materials and are not subject to international transport regulations. As long as they are kept dry their utility as a pigment is practically unlimited.

### 46.10.1.5 Uses

The use of chromium(III) oxide as a pigment for toys, cosmetics, and in plastics and paints that come in contact with food is permitted in national and international regulations [196–203]. Maximum limits for heavy metals or their soluble fractions are usually a prerequisite. Because pure starting materials are used, these limits are satisfied by most types of chromium oxide.

Chromium oxide is equally important as a colorant and in its other industrial applications. As a pigment, it is used predominantly in the paint and coatings industry for high quality green paints with special requirements, especially for steel constructions (coil coating), facade coatings (emulsion paints), and automotive coatings.

A series of RAL (Reichs Ausschuss für Lieferbedingungen) tints (e.g., Nos. 6003, 6006, 6011, 6014, and 6015) can be formulated based on chromium oxide. As mentioned previously, chromium oxide is also an important pigment for the formulation of green camouflage coatings (e.g., RAL 6031-F 9, Natogreen 285, Stanag 2338, and Forestgreen MIL-C-46168 C).

Except for the expensive cobalt green, chromium oxide is the only green pigment that meets the high color stability requirements for building materials based on lime and cement [204]. In plastics, however, chromium oxide green is only of minor importance because of its dull tint.

The industrial significance of chromium oxide is due to its chemical and physical properties. Its high purity makes it suitable as a starting material for the aluminothermic production of very pure chromium metal.

Since the late 1970s chromium oxide has gained significance as a raw material in the refractory industry. The addition of chromium oxide to bricks and refractory concrete based on alumina significantly improves their stability against slag in the production and processing of pig iron. Chromium oxide bricks containing ca. 95%  $\text{Cr}_2\text{O}_3$  have become important in the production of E-glass fibers for

lining melting tanks. These linings have substantially improved furnace stability (i.e., prolonged furnace life).

The high hardness of chromium oxide resulting from its crystal structure is exploited in polishing agents for metals and in brake linings. Addition of a small amount of chromium oxide to magnetic materials of audio and video tapes imparts a self-cleaning effect to the sound heads.

### 46.10.1.6 Economic Aspects

Important producers are American Chrome and Chemicals (USA), Bayer (Germany), British Chrome and Chemicals (UK), and Nihon Denko (Japan).

Statistical data on the consumption of chromium oxide have not been published recently. However, it can be assumed that 37 000 t of chromium oxide, including 18 000 t as pigment, were consumed in 1990 worldwide excluding the former Eastern bloc and China. Chromium oxide is produced in the former Soviet Union and China, but reliable data on production and consumption are not available.

### 46.10.1.7 Toxicology and Occupational Health

Toxicological or carcinogenic effects have not been detected in rats receiving up to 5% chromium(III) oxide in their feed [205] nor in medical studies performed in chemical plants producing chromium(III) oxide and chromium(III) sulfate [206]. The oral  $\text{LD}_{50}$  for chromium(III) oxide in the rat is  $> 10\,000$  mg/kg; it does not irritate the skin or mucous membranes.

Chromium(III) oxide is not included in the MAK list (Germany), the TLV list (USA), or in the list of hazardous occupational materials of the EC [207]. In practice, this means that chromium(III) oxide can be regarded as an inert fine dust with a MAK value of 6 mg/m<sup>3</sup>.

### 46.10.2 Chromate Pigments

The most important chromate pigments include the lead chromate (chrome yellow) and lead molybdate pigments (molybdate orange and molybdate red) whose colors range from light lemon yellow to reds with a blue hue. Chrome yellow, molybdate orange, and molybdate red are used in the production of paints, coatings, and plastics, and are characterized by brilliant hues, good tinting strength, and good hiding power. Special treatment of the pigments has allowed continual improvement of their resistance to light, weathering, chemicals, and temperature.

The chromate pigments are also combined with blue pigments (e.g., iron blue or phthalocyanine blue) to obtain high-quality chrome green and fast chrome green pigments. Molybdate orange and molybdate red pigments are often combined with red organic pigments, giving a considerable extension of the color range.

Lead chromates, lead molybdates, chrome greens, and fast chrome greens are supplied as pigment powders, low-dust or dust-free preparations, or as pastes.

#### 46.10.2.1 Chrome Yellow

The chrome yellow pigments, C.I. Pigment Yellow 34:77600 and 77603, are pure lead chromate or mixed-phase pigments with the general formula  $\text{Pb}(\text{Cr}, \text{S})\text{O}_4$  [208] (refractive index 2.3–2.65, density ca. 6 g/cm<sup>3</sup>). Chrome yellow is insoluble in water. Solubility in acids and alkalis and discoloration by hydrogen sulfide and sulfur dioxide can be reduced to a minimum by precipitating inert metal oxides on the pigment particles.

Both lead chromate and lead sulfochromate (the latter is a mixed-phase pigment) can be orthorhombic or monoclinic; the monoclinic structure is the more stable [209]. The greenish yellow orthorhombic modification of lead chromate is metastable at room temperature, and is readily transformed to the monoclinic modification under certain conditions (e.g.,

concentration, pH, temperature). The latter modification occurs naturally as crocoite.

Partial replacement of chromate by sulfate in the mixed-phase crystals causes a gradual reduction of tinting strength and hiding power, but allows production of the important chrome yellows with a greenish yellow hue.

**Production.** In large-scale production, lead or lead oxide is reacted with nitric acid to give lead nitrate solutions, which are then mixed with sodium dichromate solution. If the precipitation solutions contain sulfate, lead sulfochromate is formed as a mixed-phase pigment. After stabilization the pigment is filtered off, washed until free of electrolyte, dried, and ground.

The color of the pigment depends on the ratio of the precipitating components and other factors during and after precipitation (e.g., concentration, pH, temperature, and time). According to WAGNER [210], the precipitated crystals are orthorhombic, but change very readily to the monoclinic form on standing; higher temperatures accelerate this conversion. Almost isometric particles that do not show any dichroism can be obtained by appropriate control of the process conditions. Needle-shaped monoclinic crystals should be avoided because they lead to disadvantages such as low bulk density, high oil absorption, and iridescence in the coating film.

Unstabilized chrome yellow pigments have poor lightfastness, and darken due to redox reactions. Recent developments have led to improvements in the fastness properties of chrome yellow pigments, especially toward sulfur dioxide and temperature. This has been achieved by coating the pigment particles with compounds of titanium, cerium, aluminum, antimony, and silicon [211–219].

Carefully controlled precipitation and stabilization provide chrome yellow pigments with exceptional fastness to light and weathering, and very high resistance to chemical attack and temperature, enabling them to be used in a wide field of applications. The following qualities are commercially available:

- Unstabilized chrome yellows (limited importance)
- Stabilized chrome yellows with high color brilliance, stable to light and weathering
- Highly stabilized chrome yellow pigments
  - very stable to light and weathering
  - very stable to light and weathering, and resistant to sulfur dioxide
  - very stable to high temperature, light, and weathering
  - very stable to high temperature, sulfur dioxide, light, and weathering
- Low-dust products (pastes or powders)

Lightfast chrome yellow pigments that are coated with metal oxides (e.g., of aluminum, titanium, manganese) are produced by Du Pont [212].

A chrome yellow that is coated with large amounts of silicate and alumina and which shows improved stability to temperature, light, and chemicals is also produced by Du Pont [213].

Bayer describes pigments containing lead chromate stabilized in aqueous slurry with silicate-containing solutions and antimony(III), tin(II), or zinc compounds [214].

ICI produces light- and weatherfast chrome yellow pigments stabilized with antimony compounds and silicates in the presence of polyhydric alcohols and hydroxyalkylamines [215].

Ten Horn describes a process for the production of lead sulfochromate containing at least 50% lead chromate [216]. This has a low acid-soluble lead content (< 5% expressed as PbO, by BS 3900, Part B3, 1965).

BASF produces temperature-stable lead chromate pigments with a silicate coating obtained by hydrolysis of magnesium silicofluoride [217].

Heubach has developed a process for the alternate precipitation of metal oxides and silicates [218, 219]. A homogenizer is used to disperse the pigment particles during stabilization. Products obtained have a very good temperature resistance and very low lead solu-

bility in acid (< 1% Pb by DIN 55770, 1986 or DIN/ISO 6713, 1985).

Continuous processes for the production of chromate pigments have been developed in the United States and Hungary [220, 221].

**Uses.** Chrome yellow pigments are mainly used for paints, coil coatings, and plastics. They have a low binder demand and good dispersibility, hiding power, tinting strength, gloss, and gloss stability. Chrome yellows are used in a wide range of applications not only for economic reasons, but also on account of their valuable pigment properties. They are important base pigments for yellow colors in the production of automotive and industrial paints.

Chrome yellow pigments stabilized with a large amount of silicate play a major role in the production of colored plastics (e.g., PVC, polyethylene, or polyesters) with high temperature resistance. Incorporation into plastics also improves their chemical resistance to alkali, acid sulfur dioxide, and hydrogen sulfide.

Chrome green and fast chrome green mixed pigments are produced by combining chrome yellow with iron blue or phthalocyanine blue.

World production of chrome yellow in 1996 was 37 000 t.

#### 46.10.2.2 Chrome Orange

Chrome orange, C.I. Pigment Orange 21:77601, is a basic lead chromate with the composition  $PbCrO_4 \cdot PbO$  but is no longer of technical or economic importance.

This product was obtained by precipitating lead salts with alkali chromates in the alkaline pH range. By controlling the pH and temperature, the particle size and thus the hue could be varied between orange and red.

#### 46.10.2.3 Chrome Green and Fast Chrome Green

Chrome greens, C.I. Pigment Green 15:77510 and 77600, are combined or mixed pigments of chrome yellow and iron blue with the formula

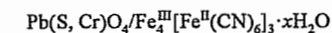

Fast chrome greens, C.I. Pigment Green 48:77600, 74160, and 74260, are combinations of chrome yellow and phthalocyanine blue or phthalocyanine green. For high-grade fast chrome greens, stabilized and highly stabilized chrome yellows are usually used.

The density and refractive index of the chrome greens and fast chrome greens depend on the ratio of the components of the mixture. Their hues vary from light green to dark blue-green, again depending on the ratio of the components.

**Production.** Chrome green and fast chrome green pigments can be prepared by dry or wet mixing.

**Dry Mixing.** The yellow and blue or green pigments are mixed and ground in edge runner mills, high-performance mixers, or mills giving intimate contact of the pigment particles. Excessive increase of temperature must be avoided, because this can lead to spontaneous combustion [222]. Differences in the density and particle size of the components can lead to segregation and floating of the pigment components in the coating. Wetting agents are therefore added to avoid these effects [223].

**Wet Mixing.** Pigments with brilliant colors, high color stability, very good hiding power, and good resistance to floating and flocculation are obtained by precipitating one component onto the other. Solutions of sodium silicate and aluminum sulfate or magnesium sulfate are then added for further stabilization [224].

Alternatively, the components are wet milled or mixed in suspension and then filtered. The pigment slurry is dried, and the pigment is ground.

**Uses.** Chrome greens have very good dispersibility, resistance to flocculation, bleeding, and floating and very good fastness properties. This is especially true of the fast chrome greens that are based on high-grade phthalocyanine and highly stabilized chrome yellows. They are therefore used in the same applications as chrome yellow and molybdate red

pigments (i.e., for the pigmentation of coating media and plastics).

Pigments consisting of zinc potassium chromates combined with blue pigments are no longer of importance.

#### 46.10.2.4 Toxicology and Occupational Health

**Occupational Health.** Precautions have to be taken and workplace concentration limits have to be observed when handling lead- and lead chromate-containing pigments. General regulations exist for all lead-containing materials [225]. Concentration limits are as follows:

|                                 |                          |
|---------------------------------|--------------------------|
| MAK value (lead)                | < 0.1 mg/m <sup>3</sup>  |
| BAT values                      |                          |
| Lead (blood)                    | < 70 µg/dL               |
| Lead (blood – women < 45 years) | < 30 µg/dL               |
| δ-Aminolevulinic acid           |                          |
| (urine, Davies method)          | < 15 mg/L                |
| (women < 45 years)              | < 6 mg/L                 |
| TLV-TWA value (lead)            | < 0.15 mg/m <sup>3</sup> |

It is accepted that the BAT limit has been complied with if the blood lead level does not exceed 50 µg/dL (or for women of < 45 years, 30 µg/dL).

The EEC Directive EEC 82/605 specifies maximum lead concentrations in the air of < 150 µg/m<sup>3</sup> and permitted blood lead levels of 70–80 µg/dL, with δ-aminolevulinic acid values of 20 mg/g creatinine [226].

MAK limits for lead chromates and lead chromate pigments are not given. They are classified as substances suspected of having carcinogenic potential (MAK: Group IIIB; TLV-TWA: 0.05 mg Cr/m<sup>3</sup>, A 2). However, extensive epidemiological investigations have given no indication that the practically insoluble lead chromate pigments have any carcinogenic properties [227, 228]. Such properties have been reported for the more soluble zinc chromate and strontium chromate pigments.

These chromate pigments can be safely handled if the various rules and regulations regarding concentration limits, safe working practices, hygiene and industrial medicine are adhered to.

**Environmental Aspects.** Dust emissions from approved manufacturing plants must not exceed 5 mg/m<sup>3</sup> for lead and chromium with a total mass flow exceeding 25 g/h (TA-Luft [229]).

According to latest German wastewater legislation [230] for inorganic pigment manufacturing processes discharging directly into public stretches of water, mass limits for lead and chromium related to tonnes of average output ( $t_{\text{prod}}$ ) are:

|                  |                           |
|------------------|---------------------------|
| Lead             | 0.04 kg/t <sub>prod</sub> |
| Chromium (total) | 0.03 kg/t <sub>prod</sub> |

These requirements recently replaced earlier legislation dating from 1984 [231]. Lower limits might be set by local or regional authorities, even for “nondirect” discharges into municipal sewer systems.

Waste containing lead and lead chromate that cannot be recycled must be taken to a special waste disposal site under proper control.

**Labeling.** In the EC lead chromate and lead chromate pigments must be appropriately labeled. Such substances must be marked with a skull and crossbone (T) [232, 233]. Additionally, the following risk (R) and safety phrases (S) must be used:

|     |   |
|-----|---|
| R61 | May cause harm to the unborn child  |
| R62 | Possible risk of impaired fertility   |
| R33 | Danger of cumulative effects  |
| R40 | Possible risks of irreversible effects  |
| S53 | Avoid exposure — obtain special instructions before use.  |
| S45 | In case of accident or if you fell unwell, seek medical advice immediately (show the label where possible). |

In the 21st adaptation to EEC Council Directive 67/548, the lead chromate pigments C.I. Pigment Yellow 34 and C.I. Pigment Red 104 have been added individually [234]. These pigments are classified in the same manner as lead chromate and must be labeled with a skull and crossbone (T) and the above mentioned risk (R) and safety phrases (S).

According to the EEC Council Directive for the labeling of preparations [235] in conjunction with the 21st adaptation to EEC Council Directive 67/548, Nota 1 [234], such materials containing more than 0.5% lead are labeled in the same way as the pure lead pig-

ment, with a skull and crossbone (T) and the corresponding R and S phrases.

With respect to improved protection of public health, special restrictions on carcinogenic and teratogenic substances and their corresponding preparations have been established by the 14th amendment of EEC Council Directive EEC 76/769 [236].

In accordance with the 14th amendment of EEC Council Directive EEC 76/769 [236] and revised ChemVerbV [237], lead chromate-based pigments and preparations are no longer permitted to be used by private consumers and have to be labeled with the phrase “Only for industrial purposes”.

Lead-containing coatings and paints with a total lead content exceeding 0.15% of the total weight of the preparation must carry the phrase “Contains lead. Should not be used on surface liable to be chewed or sucked by children” in accordance with EEC Council Directive 89/178 [238] and German GefStoffV [232].

Lead chromate pigments are not permitted for use as coloring materials for plastic for consumer goods [239] or for coatings for toys, according to European Standard EN 71 part 3 [240].

For transportation, the labeling to be used (GGVS/GGVE, ADR/RID) for the pigment as well as for its preparations is class 6.1, No. 62c, hazard symbol 6.1A, and a skull and crossbone, if the lead content soluble in hydrochloric acid [c(HCl) = 0.07 mol/L] exceeds 5%.

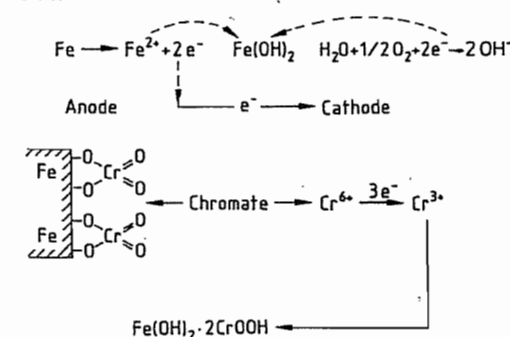

Figure 46.9: Passivation of iron by chromate pigments [248, 249].

#### 46.10.2.5 Anticorrosive Chromate Pigments

Anticorrosive chromate pigments are summarized in Table 46.15.

The anticorrosive action of the chromate pigments is based both on chemical and electrochemical reactions [241–247]. Electrochemical passivation and chemical reaction are illustrated in Figure 46.9 [248, 249]. Passivation is based on electrochemical processes in the cathodic region. In addition, a protective film is also formed by reaction of chromate ions with metal ions at the surface of the substrate to form metal oxide hydrates.

The anticorrosive properties of this class of pigments depend on:

- The content of water-soluble chromate ions
- The ratio of water-soluble chromate ions to water-soluble corrosion-promoting ions (chloride and sulfate ions)
- The active pigment surface in the coating (i.e., particle size distribution and dispersibility)

Chromate-containing pigments are classified as toxic; their use is therefore very limited and they must be appropriately labeled [250, 251].

**Zinc-Containing Chromate Pigments.** Zinc chromate is produced by reacting an aqueous slurry of zinc oxide or hydroxide with dissolved chromate ions followed by neutralization, or by precipitation of dissolved zinc salts with dissolved chromate salts. Zinc tetraoxychromate is produced from zinc oxide and chromic acid in an aqueous medium. Basic zinc potassium chromate is obtained by reacting an aqueous slurry of zinc oxide with potassium dichromate and sulfuric acid. The pigments are washed, filtered, dried, and ground.

Table 46.15: Metallic anticorrosive chromate pigments.

| Name                          | Formula  | Synonym  | Appearance                    | Solubility in water, g/L |
|-------------------------------|--|--|-------------------------------|--------------------------|
| Zinc chromate                 | ZnCrO <sub>4</sub>   | chromic acid-zinc salt (1:1)<br>zinc yellow<br>C.I. Pigment Yellow 36                      | lemon yellow powder           | insoluble                |
| Zinc tetraoxycromate          | ZnCrO <sub>4</sub> ·4Zn(OH) <sub>2</sub>                   | basic zinc chromate<br>ZTO chromate<br>zinc tetrahydroxochromate<br>C.I. Pigment Yellow 36 | yellow powder                 | ca. 0.04                 |
| Basic zinc potassium chromate | 4ZnO·K <sub>2</sub> O·4CrO <sub>3</sub> ·3H <sub>2</sub> O | basic zinc chromate<br>zinc chromate pigment<br>lemon yellow<br>C.I. Pigment Yellow 36     | lemon yellow triclinic flakes | 2.5-5                    |
| Zinc potassium chromate       | KZn <sub>2</sub> (CrO <sub>4</sub> ) <sub>2</sub> OH       | chromic acid-potassium zinc salt (2:2:1)<br>zinc yellow<br>C.I. Pigment Yellow 36          | yellow powder                 | sparingly soluble        |
| Strontium chromate            | SrCrO <sub>4</sub>   | strontium chromate A<br>strontium yellow<br>C.I. Pigment Yellow 32                         | yellow powder                 | ca. 2                    |

Trade names include Zinkchromat CZ20-CZ40 (SNCZ, France); Zinkchromat 1W (BASF, Germany); and Zinktetraoxichromat TC 20-TC 40, LOW DUST (SNCZ, France).

**Strontium Chromate.** Strontium chromate is precipitated from solutions of sodium dichromate and strontium chloride, followed by filtration, washing, drying, and grinding. A primer composition based on strontium and calcium chromates is described in [252, 253].

A trade name for strontium chromate pigments is Strontiumchromat L203 S-L203 E (SNCZ, France).

**Lead Silicochromate** [254]. Lead silicochromate, 4(PbCrO<sub>4</sub>·PbO) + 3(SiO<sub>2</sub>·4PbO), is an orange powder. This pigment is a core pigment, in which the active pigment substance (PbCrO<sub>4</sub>) is precipitated onto an inert core (SiO<sub>2</sub>).

In the production process used by National Lead Industries, a solution of chromic acid is added to an aqueous slurry of lead oxide, finely ground silica, and a small amount of basic lead acetate:

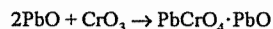

The product is heated in a rotary kiln causing the excess lead oxide to react with the basic lead chromate, forming tetrabasic lead chromate:

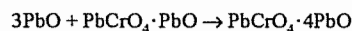

On raising the temperature the following reaction takes place on the surface of the silica:

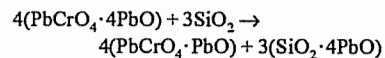

The pigment contains 47% PbO, 5.4% CrO<sub>3</sub>, and 47.6% SiO<sub>2</sub>. Properties are as follows: density 4.2 g/cm<sup>3</sup>, oil number 15 g/100 g, tamped volume 163 cm<sup>3</sup>/100 g, sieve residue (> 42 μm) 0.004%, moisture content 0.1%, and pH ca. 7.

A trade name for lead silicochromate is Onor (National Lead Chemicals, USA) [255].

### 46.10.3 Chromium Dioxide

In the course of the development of pigments for magnetic information storage, CrO<sub>2</sub> was the first pigment material that gave a higher recording density than γ-Fe<sub>2</sub>O<sub>3</sub>. In the field of audio recording this led to the IEC II standard or "chrome position".

**Physical Properties.** Chromium dioxide, chromium(IV) oxide, CrO<sub>2</sub>, is a ferromagnetic material with a specific saturation magnetization  $M_s/\rho$  of 132 Am<sup>2</sup>/kg at 0 K corresponding to the spin of two unpaired electrons per Cr<sup>4+</sup> ion. The  $M_s/\rho$  value of CrO<sub>2</sub> at room temperature is ca. 100 Am<sup>2</sup>/kg [256]; CrO<sub>2</sub> magnetic pigments reach values of 77-92 Am<sup>2</sup>/kg. The material crystallizes with a tetragonal rutile lattice in the form of small needles which have

the desired magnetic shape anisotropy. The morphology of the particles can be varied with several dopants, particularly antimony and tellurium [257]. The coercive field strength (in addition to shape) can be controlled by doping with transition metal ions which modify the magnetocrystalline anisotropy of the material; the Fe<sup>3+</sup> ion being industrially important [258]. Depending on the iron content up to ca. 3 mol%,  $H_c$  values of CrO<sub>2</sub> may vary between 30 and 75 kA/m [259, 260]. Iron doping also increases the Curie temperature from 115 to ca. 170 °C. Because the Fe<sup>3+</sup> ions are coupled antiferromagnetically with Cr<sup>4+</sup> ions in the crystal lattice, the saturation magnetization ( $M_s/\rho$ ) of CrO<sub>2</sub> decreases with increasing dopant levels [261].

Other important properties of CrO<sub>2</sub> when used as a magnetic pigment are its black color, electrical conductivity (2.5-400 Ω<sup>-1</sup>cm<sup>-1</sup> [262]) and relatively high crystal hardness (Mohs hardness 8-9 [263]). Therefore, coating formulations based on CrO<sub>2</sub> require less or even no additives such as carbon black (good conductivity, black color) or refractory oxides such as alumina.

**Chemical Properties.** Pure CrO<sub>2</sub> slowly disproportionates in the presence of water. The CrO<sub>2</sub> crystal surface of commercial pigments is therefore topotactically converted to β-CrOOH which serves as a protection layer [264]. The conditions for this reaction have a great influence on the chemical properties of the pigment surface [265, 266]. Thus, the isoelectric point in water can vary between pH 3 and 7 [263], which affects dispersibility. In the absence of moisture, CrO<sub>2</sub> is stable up to ca. 400 °C; above this temperature it decomposes to form Cr<sub>2</sub>O<sub>3</sub> and oxygen.

**Uses and Economic Aspects.** Chromium dioxide is used exclusively for magnetic recording media, e.g., tapes for audio, video, and computer applications. An application of particular interest depends on its relatively low Curie temperature. This allows thermomagnetic duplication at temperatures low enough for the base polymer of magnetic tapes, and is exploited in a commercial, high-speed copy-

ing process [267]. Chromium dioxide may also be used in combination with cobalt-modified iron oxides in the production of magnetic recording media. The world production of CrO<sub>2</sub> in 1990 amounted to 8000 t, ca. 12% of the total consumption of magnetic pigments. Producers are BASF and Du Pont.

Table 46.16: Composition and properties of chromium phosphate pigments.

| Property (standard)  | Chromium phosphate<br>ZnPO <sub>4</sub> ·3H <sub>2</sub> O |
|--|--|
| Metal content, % (ISO 787, part 2)                         | ca. 27   |
| Phosphate content, % (ISO 787, part 2)                     | ca. 47   |
| Chloride content, % (ISO 787, part 13)                     | < 0.1  |
| Sulfate content, % (ISO 787, part 13)                      | 0.04   |
| Water-soluble content, % (ISO 787, part 3)                 | 0.4  |
| Sieve residue, % (ISO 787, part 18)                        | max. 0.3   |
| Density, g/cm <sup>3</sup> (ISO 787, part 10)              | 2.5  |
| Specific surface area, m <sup>2</sup> /g (DIN 66131/66132) | 22   |
| Loss on ignition, % (ISO 787, part 2)                      | 26   |
| Oil absorption value, g/100 g (ISO 787, part 5)            | 65   |
| Conductivity, μS (ISO 787, part 14)                        | ca. 500  |
| pH (ISO 787, part 9)                                       | 6.5  |
| Color  | green  |

### 46.10.4 Chromium Phosphate

[268, 269]

Chromium phosphate, CrPO<sub>4</sub>·3H<sub>2</sub>O, is produced from chromium(III) salts and alkali phosphates. The physical and chemical properties are listed in Table 46.16 [268].

Chromium phosphate has a low solubility. It is therefore nearly always used in combination with other anticorrosive pigments. It is an extremely good long-term inhibitor, but is less effective during the initial phase of corrosion protection.

## 46.11 References

1. Gmelin, Chromium, Part A (1962) pp. 1-5.
2. J. W. Mellor: *Comprehensive Treatise on Inorganic and Theoretical Chemistry*, vol. 11, Longmans Green & Co., London 1931, p. 122.
3. M. J. Udy: *Chromium*, vol. 1, Reinhold Publ. Co., New York 1956, p. 1.

4. J. F. Papp: "Mineral Facts and Problems", U.S. Bureau of Mines Bulletin no. 675, 1985, Chapter on Chromium.
5. T. Matsumura, J. Hagiya, *Toya Soda Kenkyu Hokoku* 22 (1978) no. 2, 75-89.
6. C. L. Rollinson: *Comprehensive Inorganic Chemistry*, vol. 3, Pergamon Press, Oxford 1973, p. 624.
7. F. A. Cotton, G. Wilkinson: *Advanced Inorganic Chemistry*, Interscience, New York 1966, p. 818.
8. L. B. Pankratz: "Thermodynamic Properties of Elements and Oxides", U.S. Bureau of Mines Bulletin no. 672, 1982, p. 117.
9. A. H. Sully: *Chromium*, Academic Press, New York 1954, pp. 21-29.
10. M. C. Carosella, J. D. Mettler, *Met. Prog.* 69 (1956) no. 6, 51.
11. J. B. Rosenbaum, R. R. Lloyd, C. C. Merrill, U.S. Bureau of Mines, R.I. no. 5322, March, 1957.
12. M. Pourbaix: *Atlas of Electrochemical Equilibria*, Pergamon Press, Oxford 1966, p. 262.
13. H. F. Reichard, H. R. Spendelow, "Chromium", London Metal Bulletin Survey, London 1977.
14. A. N. Rakitskii, V. I. Trefilov, *Poroshk. Metall.* 160 (1976) no. 4, 20-30.
15. Shin Nippon Iron K.K., JP 54156013, 1979 (K. Katayama).
16. SAE, ASTM (eds.): *Metals & Alloys in the Unified Numbering System*, 4th ed., SAE, Warrendale, Pa., 1986, pp. 185-195, 209-211, 217, 359-361.
17. R. C. Gibbons: *Woldman's Engineering Alloys*, 6th ed., American Society for Metals, Metals Park, Ohio, 1979.
18. K. Wellinger, P. Gimmel, M. Bodenstein: *Werkstofftabellen der Metalle*, 7th ed., Kroner, Stuttgart 1972.
19. Union Carbide Corp., US 3592637, 1971.
20. P. D. Deeley, K. J. A. Kundig, H. R. Spendelow, Jr.: *Ferroalloys and Alloying Additives Handbook*, Shield-alloy Corp., Newfield, N.J., 1982, p. 29.
21. A. H. Sully, E. A. Brandes: *Metallurgy of the Rare-Earth Metals - Chromium*, 2nd ed., Butterworth, London 1967.
22. Alloy Surfaces Co., US 3222212, US 3375128, 1962.
23. G. M. Baughman, *Iron & Steel Eng.* 1972 (Sept.), 91-101.
24. *Gmelin*, System no. 52, Chrom.
25. M. J. Udy: *Chromium*, vol. 1, Reinhold, New York 1956.
26. A. H. Sully, E. A. Brandes: *Chromium*, 2nd ed., Butterworth, London 1967.
27. Minerals Yearbook U.S. Bureau of Mines, Washington, DC, 1983.
28. *Chromium minerals. World Survey of Production and Consumption*. ROSKILL Information Services Ltd., London 1972.
29. *Mining J. (London)*, Mining annual review 1985.
30. Mineral Facts and Problems, U.S. Bureau of Mines Bull. 650, 1970.
31. H. Borchert: "Principles of the genesis and enrichment of chromite ore deposits", in *Methods of prospecting for chromite*, OECD, Paris 1964, pp. 175-202.
32. S. Janković: *Wirtschaftsgeologie der Erze*, Springer, Wien 1967.
33. H. Kern: "Zur Geochemie und Lagerstättenkunde des Chroms und zur Mikroskopie und Genese der Chromerze", *Clausthaler Hefte zur Lagerstättenkunde und Geochemie der Mineralischen Rohstoffe*, no. 6, Bornträger, Berlin 1968.
34. T. Lukkarinen, L. Heikkilä: "Beneficiation of chromite ore, Kemi, Finland", *10th International Processing Congress 1973*, Inst. Min. Met., London 1973.
35. H. Schneiderhöhn: *Die Erzlagerstätten der Erde*, vol. I, Gustav Fischer, Stuttgart 1958.
36. T. Shabad: *Basic industrial resources of USSR*, Columbia University Press, New York 1969.
37. H. Strunz: *Mineralogische Tabellen*, Akadem. Verlagsges., Leipzig 1966.
38. A. Sutulov: *Mineral resources and the economy of the USSR*, McGraw-Hill, New York 1973.
39. H. D. B. Wilson (ed.): *Magmatic ore deposits, a symposium*, monograph 4, Economic Geology Publ. Co., Lancaster, PA, 1969.
40. Bayer AG, DE-AS 1533076, 1966.
41. Bayer AG, FR 1531069, 1967.
42. Bayer AG, DE-OS 1926660, 1969.
43. S. K. Cirkov, *Zh. Prikl. Khim. (Leningrad)* 13 (1940) 521-527.
44. Associated Chemical Comp., DE-OS 1467298, 1963.
45. G. N. Bogachov et al., *Khim. Promst. (Moscow)* 1961, 655.
46. Produits chimiques Ugine Kuhlmann, DE-OS 2329925, 1972.
47. Bayer AG DE-AS 1533077, 1966.
48. C. K. Williams, US 2695215, 1950.
49. R. N. Mitra, N. R. Dhar, *J. Indian Chem. Soc.* 9 (1932) 315-327.
50. Pacific Bridge Co., US 2431075, 1945/47.
51. I. G. Farben, DE 492684, 1927.
52. F. Wöhler, *Justus Liebigs Ann. Chem.* 111 (1859) 117-121.
53. DuPont, US 2885365, 1959 (A. L. Oppgard).
54. DuPont, US 2956955, 1960 (P. Arthur).
55. T. J. Swoboda, P. Arthur, N. L. Cox, J. N. Ingraham, A. L. Oppgard et al., *J. Appl. Phys.* 32 (1961) 374-375.
56. F. Hund, *Farbe + Lack* 78 (1972) 11-16.
57. E. Köster, "Neue Werkstoffe für magn. Speicherschichten", in H. H. Mende (ed.): *Neuere magn. Werkstoffe und Anwendungen magn. Methoden*, Verlag Stahlisen, Düsseldorf 1983, pp. 149-170.
58. B. L. Chamberland, *CRC Crit. Rev. Solid State Mater. Sci.* 7 (1977) 1-31.
59. D. S. Chapin, J. A. Kafalas, J. M. Honig, *J. Phys. Chem.* 69 (1965) 1402-1409.
60. L. Brewer, *Chem. Rev.* 52 (1953) 9.
61. F. J. Darnell, W. H. Cloud, *Bull. Soc. Chim. Fr.* 1965, 1164-1166.
62. BASF, unpublished, 1983.
63. DuPont, US 3034988, 1962 (J. N. Ingraham, T. J. Swoboda).
64. F. J. Darnell, *J. Appl. Phys.* 32 (1961) 1269.
65. H. Y. Chen, D. M. Hiller, J. E. Hudson, C. J. A. Westbroek, *IEEE Trans. Magn. MAG-20* (1984) 24-26.
66. CNRS, DE-OS 3209739, 1982 (G. Demazeau, P. Maestro, M. Pouchard, P. Hagenmuller et al.).

67. J. B. Goodenough, *Bull. Soc. Chim. Fr.* 1965, 1200-1207.
68. D. S. Rodbell, J. M. Lommel, R. C. DeVries, *J. Phys. Soc. Jpn.* 21 (1966) 2430.
69. J. Boháček, *J. Signallaufzeichnungsmater.* 8 (1980) 55-60.
70. DuPont, US 3512930, 1970 (W. G. Bottjer, H. G. Ingersoll).
71. BASF, DE-OS 2749757, 1977 (G. Vath, M. Ohlinger, H. J. Hartmann, M. Velic et al.).
72. Montedison, EP 29687, 1980 (G. Basile, G. Boero, E. Mello Ceresa, F. Montino).
73. W. Ostertag, W. Stumpf, R. Falk, M. Ohlinger, *Elektronik-Anzeiger* 11 (1972) 225-227.
74. Montedison, DE 2648305, 1976 (G. Basile, A. Mazza, M. Spinetta).
75. DuPont, US 3278263, 1966 (N. L. Cox).
76. G. R. Cole, L. C. Bancroft, M. P. Chouinard, J. W. McCloud, *IEEE Trans. Magn. MAG-20* (1984) 19-23.
77. P. J. Flanders, *IEEE Trans. Magn. MAG-12* (1976) 348-355.
78. Bayer AG, DE 1203748, 1961.
79. Aktjubinskij Sawod Chromowych Isdelij, DE-OS 2119450, 1971.
80. Bayer AG, DE 1065394, 1958.
81. Diamond Alkali Co., US 2993756, 1959.
82. Diamond Alkali Co., DE-OS 2018602, 1970.
83. Diamond-Shamrock Corp., DE-OS 3020260, 1980.
84. Diamond-Shamrock Corp., DE-OS 3020261, 1980.
85. Diamond-Shamrock Corp., DE-OS 3020280, 1980.
86. A. Werner, P. Pfeiffer: *Neue Anschauungen auf dem Gebiet der anorganischen Chemie*, 5th ed., Vieweg, Braunschweig 1923.
87. Griesheim Elektron, DE 369816, 1920.
88. R. B. Norden, *Chem. Eng.* 63 (1956) 308-311.
89. Degussa, FR 817502, 1936.
90. Pittsburgh Plate Glass Co., US 2185218, 1938.
91. I. G. Farben, DE 514571, 1925.
92. Bayer AG, DE 1467327, 1963.
93. W. F. Rogers: *Composition and Properties of Oil Well Drilling Fluids*, Gulf Publ. Co., Houston, TX, 1963, pp. 459-464.
94. Farbenfabriken Meister Lucius Bruning, DE 103860, 1898.
95. M. J. Udy, US 1739107, 1925.
96. M. J. Udy, GB 546681, 1940.
97. Ass. Chem. Comp., DE-AS 1467298, 1964.
98. Ethyl Corp., DE-AS 1159913, 1959.
99. G. Brauer: *Handbuch der präparativen anorganischen Chemie*, 2nd ed., vol. 2, Enke Verlag, Stuttgart 1962.
100. DuPont, DE-AS 1272909, 1960.
101. I. M. Kolthoff, P. J. Elving (eds.): *Treatise on Analytical Chemistry*, Part II, vol. 8, Interscience, New York-London 1963, pp. 301ff.
102. See [101], p. 326.
103. See [101], pp. 327-328.
104. See [101], p. 330.
105. See [101], pp. 338-339.
106. C. Veillon, K. Y. Patterson, N. A. Bryden, *Analytica Chim. Acta* 164 (1984) 67-76.  
A. G. Cox, G. Cook, C. W. McLeod, *The Analysis* 110 (1985) 331-333.
107. *EEC Directive* of June 27, 1967 (67/548/EEC); *EEC Directive* of July 14, 1976, 1st amendmenf (69/907/EEC).
108. *International Maritime Dangerous Goods Code* (IMDG Code).
109. "Katalog wassergefährdender Stoffe" (List of water-hazard chemicals), Bundesministerium des Inneren, March 1, 1985 (GM Bl p. 175).
110. EPA: *Ambient Water Quality Criteria for Chromium*, Washington, DC, NTIS No. PB 81-117647, 1980.
111. State of Baden-Württemberg (FRG): *Wastewater Requirements*, June 28, 1978, no. 74-5040.
112. *Technische Anleitung zur Reinhaltung der Luft* (TA Luft), Febr. 28, 1986.
113. *EEC Directive on poisonous and hazardous wastes*, March 20, 1978 (78/319/EEC).
114. Klärschlammverordnung, June 25, 1982, BG Bl 1, p. 734.
115. EPA, Municipal Construction Div.: "Application of Sewage Sludge to Cropland. Appraisal of Potential Hazards of the Heavy Metals to Plants and Animals", NTIS PB-264015, EPA-430/9-76-013, Nov. 15, 1976.
116. G. Schmid, W. Pauckner, *Leder* 35 (1984) 165-171.
117. C. N. Durfor, E. Becker, *U.S. Geol. Survey Wafer Supply*, Paper No. 1812, 1964.
118. NAS-U.S. *Geochemistry and the Environment*, Washington, DC, U.S. Government Printing Office, 1974.
119. RIWA annual report 1983, Part A: *Der Rhein*, Aug. 1984, p. 60/61.
120. B. Hamburger, H. Häberling, H. R. Hirtz, *Arch. Fischereiwiss.* 28 (1977) 45-55.
121. G. Bringmann, R. Kühn, *Gesund. Ing.* 80 (1959) no. 4, 115-120.
122. NIOSH, Registry of Toxic Effects of Chemical Substances 1985.
123. R. A. Griffin et al., *J. Environ. Sci. Health Part A* A12 (1977) 431-449.
124. H. Rasp, *Leder* 32 (1981) 188-203.
125. D. Sauerbeck, *Zeitschrift des Verbandes Deutscher Landwirtschaftlicher Untersuchungs- und Forschungsanstalten (VDLUFa)*, Landwirtschaftliche Forschung, special issue no. 39, Kongressband 1982, pp. 108-129.
126. Unpublished results, Bayer AG, May 1985.
127. P. Friesel et al. (Bundesgesundheitsamt): *Überprüfung der Durchführbarkeit und der Aussagekraft der Stufe 1 und 2 des Chemikaliengesetzes*, Umweltbundesamt (UBA) Forschungsbericht 1984.
128. H. W. Marquart et al. (Bayer AG), in [127].
129. G. Bringmann, R. Kühn, *Haustech. Bauphys. Umwelttech. Gesund. Ing.* 100 (1979) 250.
130. W. Kördel et al. (Fraunhofer-Institut für Toxikologie und Aerosolforschung), in [127].
131. G. Bringmann, R. Kühn, *Z. Wasser Abwasser Forsch.* 15 (1982) 1-6.
132. Unpublished results, Bayer AG, 1978.
133. U.S. Federal Register 45, No. 231, of 28th Nov. 1980, p. 79331.
134. H. J. M. Bownes: *Environmental Chemistry of the Elements*, Academic Press, London 1979.

135. *Chrom, Bachsedimente* (creek sediments), Bundesanstalt für Geowissenschaften und Rohstoffe, Hannover 1984.
136. Umweltbundesamt, Jahresbericht 1982, Berlin 1983, pp. 33, 35.
137. D. J. Swaine, R. L. Mitchell, *J. Soil Sci.* **11** (1960) no. 2, 347-368.
138. S. Langard: *Biological and Environmental Aspects of Chromium*, Elsevier, Amsterdam 1982, p. 58.
139. S. Langard, in [138], p. 60, 62.
140. U.S. Geological Survey Circular 930-B, 1984.
141. U.S. Bureau of Mines: Mineral Commodity Summaries 1984.
142. U.S. Bureau of Mines: Mineral Commodity Summaries 1985.
143. T. Power: "Chromite - the non metallurgical markets", *Industrial Minerals* **1985**, April, 17-51.
144. Minerals Bureau, International Report No. 86, Braamfontein.
145. D. Henschler: *Gesundheitsschäd. Arbeitsstoffe*, Verlag Chemie, Weinheim 1973.
146. W. Merz, K. Schwarz, *Am. J. Physiol.* **196** (1959) 614-618.
147. W. Mertz, *Proc. Nutr. Soc.* **33** (1974) 307-313.
148. R. A. Anderson, *Sci. Total Environ.* **17** (1981) 13-28.
149. J. A. Schouten, C. M. van Gent, *Diabetes Praxis* **1983**, no. 1, 2-5.
150. Deutsche Forschungsgemeinschaft, Forschungsbericht Schadstoffe im Wasser, 1982, p. 411.
151. F. J. Diehl, in [125], p. 53.
152. S. Langard, in [138], p. 122.
153. T. D. Luckey et al.: *Heavy Metal Toxicity, Safety and Homology*, G. Thieme, Academic Press 1975, p. 49.
154. U. Korallus, H. Lange, A. Neiß, E. Wüstefeld, T. Zwingers, *Arb. Med., Soz. Med., Präy. Med.* **17** (1982) 159-167.
155. U. Korallus, C. Harzdorf, J. Lewalter, *Int. Arch. Occup. Environ. Health* **53** (1984) 247-250.
156. F. L. Petrilli, S. de Flora, *Appl. Environ. Microbiol.* **33** (1977) 805-809.
157. F. L. Petrilli, S. de Flora in: *Mutagens in our Environment*, A. R. Liss, New York 1982, pp. 453-464.
158. EPA Health Assessment Document for Chromium, August 1984 (EPA-600/8-83-D14F).
159. W. C. Hueper, W. W. Payne, *Arch. Environ. Health* **5** (1962) 445-462.
160. L. S. Levy, Fac. of Sc., University of London, 1975.
161. NIOSH (1975) Criteria for a recommended standard. Occ. exposure to chromium(VI), US DHEW, Washington, DC.
162. D. Steinhoff, C. Gad, G. T. Hatfield, U. Mohr, *Exp. Pathol.* (1986), in the press.
163. U. Korallus, H. Ehrlicher, E. Wüstefeld, *Arb. Med., Soz. Med., Präy. Med.* **3** (1974) 51-54; 76-79; 248-252.
164. W. Machle, F. Gregorius, *U.S. Publ. Hlth. Rep.* **63** (1948) no. 35, 1114-1127.
165. T. Mancuso, W. C. Hueper, *Ind. Med. Surg.* **20** (1951) 358-363.
166. M. R. Alderson, N. S. Rattan, L. Bidstrup, *Br. J. Ind. Med.* **38** (1981) 117-124.
167. R. B. Hayes, A. M. Lilienfeld, L. M. Snell, *Int. J. Epidemiol.* **8** (1979) 365-374.
168. W. J. Hill, W. S. Ferguson, *JOM J. Occup. Med.* **21** (1979) 103-106.
169. H. Satoh, Y. Fukuda, K. Teric, N. Chike Katsumo, *JOM J. Occup. Med.* **23** (1981) 835-838.
170. J. M. Davies, *Br. J. Ind. Med.* **41** (1984) 148-169.
171. R. Frenzel-Beyme, *J. Cancer Res. Clin. Oncol.* **105** (1983) 183-188.
172. S. Langard, T. Norseth, *Br. J. Ind. Med.* **32** (1975) 62-65.
173. H. Royle, *Environ. Res.* **10** (1975) 141-163.
174. G. Axelsson, R. Rylander, A. Schmidt, *Br. J. Ind. Med.* **37** (1980) 121-127.
175. S. Langard, A. Andersen, B. Gylseth, *Br. J. Ind. Med.* **37** (1980) 114-180.
176. J. Lewalter, U. Korallus, C. Harzdorf, H. Weidemann, *Internat. Arch. Occ. Environ. Health* **55** (1985) 305-318.
177. "Properties and Economics", *Pigment Handbook*, 2nd ed., vol. I, John Wiley & Sons, New York 1988, pp. 309-310.
178. S. Keifer, A. Wingen, *Farbe + Lack* **79** (1973) 866-873.
179. J.-L. Lassaigne, *Ann. Chim. Phys. Ser. 2* **14** (1820) 299-302.
180. H. C. Roth, US 1728510, 1927.
181. PPG Industries, US 4127643, 1977 (W. W. Carlin).
182. BASF, EP-A 0238713, 1986 (N. Müller et al.).
183. Pfizer Inc., EP 0068787, 1982 (V. P. Rao).
184. Bayer, US 4040860, 1976 (L. Mansmann, W. Rambold).
185. Bayer, DE 2635086, 1976 (W. Rambold, H. Heine, B. Raederscheidt, G. Trenczek).
186. British Chrome & Chemicals, US 4296076, 1981 (A. S. Dauvers, M. A. Marshall).
187. C. K. Williams & Co., US 2250789, 1940 (I. W. Ayers).
188. Bayer, DE 1257317, 1963 (F. Hund, D. Råde).
189. Bayer, DE-OS 2358016, 1973 (B. Knickel et al.).
190. Colores Hispania S. A., ES 438129, 1975.
191. C. K. Williams & Co., US 2560338, 1950 (C. G. Frayne); C. K. Williams & Co., US 2695215, 1950 (W. A. Pollock).
192. Bayer, US 3723611, 1971 (G. Broja, K. Brandle, C. H. Elstermann).
193. Gefahrstoffverordnung - GefStoffV Dec. 16, 1987 (BGBl. I, 2721).
194. Bayer, DE 3123361, 1981 (J. Rademachers et al.).
195. 37. Abwasser VWV 05. Sept. 1984, GMBL Nr. 22, 344; Water Pollution Control Law, Law No. 138, Dec. 25, 1970 (Japan).
196. 178. Mitteilung BGesundhBl. 31 (1988) 363.
197. *Journal officiel de la République française* no. 1227 (1983) 75, 97, 109.
198. *Gazzetta Ufficiale della Repubblica Italiana*, Apr. 20, 1973, 3, 4.
199. *Belgisch Staatsblad - Moniteur belge* Sept. 24, 1976, 12030.
200. Verpakkingen - en Gebruiksartikelenbesluit (Warenwert) 01. Oct. 1980.
201. EG-Guidelines EEC 88/378, official gazette L 187 16. July 1988.
202. EEC Council Directive, EEC 76/768, on cosmetic products (18th Suppl.).
203. Japanese Pharmaceutical Affaires 1980.

204. E. Püttbach, *Betonwerk + Fertigteiltechnik* **2** (1987) 124-132.
205. S. Ivankovic, R. Preussmann, *Ed. Cosmet. Toxicol.* **13** (1975) 347-351.
206. U. Korallus, H. Ehrlicher, E. Wüstefeld, *ASP* **3** (1974) 51 ff.
207. EG-Guidelines 67/548/EEC 1967 and Suppl.
208. F. Hund, *Farbe + Lack* **73** (1967) 111-120.
209. L. J. H. Erkens et al., *J. Oil Colour Chem. Assoc.* **71** (1988) no. 3, 71-77.
210. H. Wagner et al., *Z. Anorg. Allg. Chem.* **208** (1931) 249; *Farben-Ztg.* **38** (1933) 932.
211. J. F. Clay & Cromford Color, GB 730176, 1951; H. Lesche, *Farbe + Lack* **65** (1959) 79, 80.
212. Du Pont, US 2808339, 1957 (J. J. Jackson).
213. Du Pont, DE-OS 1807891, 1969 (H. R. Linton).
214. Bayer, DE-OS 1952538, 1969 (C. H. Elstermann, F. Hund).
215. ICI, DE-OS 2049519, 1970 (Ch. H. Buckley, G. L. Collier, J. B. Mitchell).
216. Ten Horn Pigment, DE-OS 2600365, 1976 (J. J. Einerhand et al.).
217. BASF, DE 3323247 A1, 19X3 (E. Liedek et al.).
218. Heubach, DE 3806214 A1, 1988 (I. Ressler, W. Horn, G. Adrian).
219. Heubach, DE 3906670 A1, 1989 (I. Ressler, W. Horn, G. Adrian).
220. R. Williams, Jr.: "Continuous Chrome Yellow Process", *Chem. Eng. (N.Y.)* 1949, March.
221. Chemokomplex Vegyipari-Gep és Berendezes Export, Import Vallalat, DE-AS 1592848, 1971 (J. Scholtz et al.).
222. E. Renkwitz, *Farben-Ztg.* **28** (1923) 1066; H. Levecke, *Farbe + Lack* **42** (1936) 41-43; H. Berger, *Arbeitsschutz*: 1941, III/44.
223. *Paint Oil Chem. Rev.* **95** (1933) 86-92; A. E. Newkirk, S. C. Horning, *Ind. Eng. Chem. Ind. Ed.* **33** (1941) 1402-1407.
224. Sherwin-Williams, US 2237104, 1938 (N. F. Livingston).
225. *Internationale MAK-Werte-Liste* (1990) Ecomed Verlag; *TRGS 505 Blei* (1988), Carl Heymanns Verlag.
226. EEC Council Directive, EEC 82/605, July 28, 1982.
227. J. M. Davies, *Lancet* **2** (1978) 18; *Br. J. Ind. Med.* **41** (1984) 158-169.
228. W. C. Cooper, Dry Colour Manufacturers' Association, Arlington 1983.
229. TA-Luft (Technische Anleitung zur Reinhaltung der Luft (1986), C. H. Beck'sche Verlagshandlung, München 1987.
230. 37. Anhang zur Rahmen-Abwasser-Verwaltungsvorschrift vom 27.08.1991; § 7 a Wasserhaushaltsgesetz.
231. 37. Abwasser VwV (05.09.1984) für Direkteinleiter (Herstellung Anorganischer Pigmente).
232. Gefahrstoffverordnung (GefStoffV) vom 26.10.1993, Stand 10.94, und Chemikalien-Verbotsverordnung (ChemVerbV) vom 26.10.1993, Stand 10.94, Deutscher Bundesverlag GmbH, Bonn.
233. EEC Council Directive EEC 67/548, June 27, 1967 together with EEC Council Directive EEC 93/21, April 27, 1993 (18th adaption to EEC 67/548) and EEC Council Directive EEC 93/72, Sept. 1st, 1993 (19th adaption to EEC 67/548).
234. EEC Council Directive EEC 94/46, Dec. 12, 1994 (21th adaption to EEC 67/548).
235. EEC Council Directive EEC 93/18, April 5, 1993 (3rd adaption to EEC 88/379).
236. Erste Verordnung zur Änderung chemikalienrechtlicher Verordnungen vom 12. Juni 1996, Deutscher Bundesverlag GmbH, Bonn.
237. EEC Council Directive EEC 94/60, Dec. 20, 1994 (14th amendment of EEC 76/769).
238. EEC Council Directive EEC 89/178, Feb. 22, 1989.
239. Lebensmittel- und Bedarfsgegenständegesetz vom 15.08.1974 (BGBl. S. 1945).
240. Sicherheit von Spielzeug (Safety of toys) EB 71 Part 3, Dec. 1994.
241. M. Cohen, F. J. Beck, *Z. Elektrochem.* **61** (1958) 696.
242. J. D'Ans, V. Groope, *Dtsch. Farben-Z.* **15** (1961) 51, 69.
243. U. R. Evans, *J. Chem. Soc.* **1927**, 1020.
244. J. E. D. Mayne, *J. Chem. Soc.* **1948**, 1932.
245. J. L. Rosenfeld, *Lakokras. Mater. Ikh. Primen.* **1961** 50.
246. H. H. Uhlig, *Chem. Eng. News* **24** (1946) 3154.
247. G. H. Cartledge, *Corrosion (Houston)* **18** (1962) 316.
248. J. Ruf: *Korrosionsschutz durch Lacke und Pigmente*, A. W. Colomb, H. Heenemann GmbH, Stuttgart-Berlin 1972.
249. J. Ruf, *Farbe + Lack* **75** (1969) no. 10, 943.
250. GefStoffV, TRGA 602, part 2, 1987.
251. Verordnung über gefährliche Arbeitsstoffe (Arbeitsstoffverordnung - ArbStoffV) Feb. 11, 1982 (BGBl. I, 144).
252. Nippon Paint KK, JP 61276861, 1985.
253. Société nouvelle des couleurs zinciques, company information, Beauchamp 1990.
254. G. Lincke, O. Schroers, K. D. Nowak, *Farbe + Lack* **82** (1976) no. 11, 103.
255. NL Chemicals: *Nalcin 2*, company information, Hightstown, NJ 1983.
256. M. Kryder et al., *IEEE Trans. Magn.* **MAG-23** (1987) 45.
257. Du Pont, US 2923683, 1957 (J. N. Ingraham et al.). Bayer, DE-AS 1467328, 1963 (F. Hund et al.).
258. Du Pont, US 3034988, 1958 (J. N. Ingraham et al.).
259. E. Köster in C. D. Mee, E. D. Daniel (eds.): *Magnetic Recording*, vol. I, McGraw-Hill, New York 1987.
260. H. Auweter et al., *IEEE Trans. Magn.* **MAG-26** (1990) 66.
261. M. W. Müller et al., *IEEE Trans. Magn.* **MAG-26** (1990) 1897.
262. Ullmann, A7, 77 ff.
263. BASF, unpublished.
264. M. Essig et al., *IEEE Trans. Magn.* **MAG-26** (1990) 69.
265. Du Pont, US 3512930, 1968 (W. G. Bottjer et al.).
266. BASF, EP-A 218234, 1985 (W. Steck et al.).
267. G. K. Cole et al., *IEEE Trans. Magn.* **MAG-20** (1984) 19.
268. Ten Horn Pigment bv., company information, Maasricht 1977.
269. H. Wienand, W. Ostertag, *Farbe + Lack* **88** (1982) no. 3, 183-188.

## 47 Manganese

PETER M. CRAVEN, JOHN W. WAUDBY, DAVID BRUCE WELLBELOVED (§§ 47.1–47.9); ARNO H. REIDIES (§ 47.10)

|        |  |      |           |   |      |
|--------|--|------|-----------|---|------|
| 47.1   | History  | 1813 | 47.8.2    | Legal Considerations and Nodule Recovery                  | 1830 |
| 47.2   | Properties   | 1814 | 47.8.3    | Processing  | 1831 |
| 47.3   | Occurrence   | 1815 | 47.8.3.1  | Gaseous Reduction and Ammoniacal Leach Process            | 1831 |
| 47.4   | Mining and Beneficiation   | 1816 | 47.8.3.2  | Cuprion Ammoniacal Leach Process                          | 1831 |
| 47.5   | Reduction of Manganese Oxides  | 1818 | 47.8.3.3  | Elevated Temperature and Pressure $H_2SO_4$ Leach Process | 1832 |
| 47.5.1 | Manganese–Oxygen System  | 1818 | 47.8.3.4  | Reduction and HCl Leach Process                           | 1832 |
| 47.5.2 | Reduction of Manganese Oxides with Carbon Monoxide, Hydrogen, and Carbon | 1819 | 47.8.3.5  | Smelting and $H_2SO_4$ Leach Process                      | 1834 |
| 47.5.3 | Reduction of Mixed Oxides and Minerals Containing Manganese Oxides       | 1820 | 47.8.4    | Economic Viability and Future Prospects                   | 1835 |
| 47.5.4 | Reduction of Manganese Oxides by Silicon                                 | 1821 | 47.9      | Economic Aspects  | 1836 |
| 47.5.5 | Reduction of Manganese Oxide by Aluminum                                 | 1821 | 47.10     | Compounds   | 1837 |
| 47.6   | Production of Manganese Metal  | 1821 | 47.10.1   | Introduction  | 1837 |
| 47.6.1 | Electrolysis of Aqueous Manganese Salts                                  | 1823 | 47.10.2   | Oxides  | 1838 |
| 47.6.2 | Electrothermal Process   | 1826 | 47.10.2.1 | Manganese(IV) Oxide                                       | 1838 |
| 47.6.3 | Aluminothermic Process   | 1826 | 47.10.2.2 | Other Oxides  | 1844 |
| 47.6.4 | Silicothermic Process  | 1827 | 47.10.3   | Manganese(II) Salts                                       | 1846 |
| 47.6.5 | Distillation of Ferromanganese   | 1827 | 47.10.4   | Higher Oxidation-State Manganates                         | 1848 |
| 47.6.6 | Electrolysis of Fused Salts  | 1827 | 47.10.4.1 | Potassium Manganates(V) and (VI)                          | 1848 |
| 47.7   | Manganese in the Iron and Steel Industry                                 | 1827 | 47.10.4.2 | Potassium Permanganate                                    | 1848 |
| 47.8   | Processing of Manganese Nodules and Encrustations                        | 1828 | 47.10.4.3 | Sodium Permanganate                                       | 1855 |
| 47.8.1 | Occurrence, Origin, and Composition                                      | 1828 | 47.10.5   | Miscellaneous Compounds                                   | 1856 |
|        |  |      | 47.10.6   | Occupational Health and Environmental Aspects             | 1856 |
|        |  |      | 47.11     | References  | 1857 |

### 47.1 History [1, 2]

There is some dispute over the origin of the name “manganese”. Deposits of manganese ore (probably pyrolusite) were apparently found near Magnesia in Asia Minor. This was referred to by PLINY around 50 B.C. as *magnesia negra* to distinguish it from *lapis magnes* (magnetite), which has a similar appearance and density. The name pyrolusite was derived only in 1826.

The useful properties of manganese were probably first identified in the mineral pyrolusite, which was used by the ancient Egyptians and Romans to control the color of glass.

Small additions of the ore removed the greenish yellow discoloration caused by iron impurities, while further additions imparted pink, purple, or black colorations.

During the 1400s the name braunstein was used for all the manganese oxide ores. SCHEELER recognized manganese as an element in 1774, and GAHN succeeded in isolating the metal for the first time during the same year. The name manganese was first used by BUTTMAN in 1808.

Manganese ore may have been used in iron-making for centuries, but found formal usage in iron- and steelmaking only at the beginning



of the 19th century. Ferromanganese was first produced on an industrial scale in 1841 by POURCEL in France for use in crucible steels, and by 1850 spiegeleisen (an alloy of 20% manganese and iron) had been produced commercially in Prussia. The Bessemer process was made practical by MUSHET, who advised the addition of spiegeleisen in 1856/1857. The use of ferromanganese as an additive to steel to counteract the harmful effects of sulfur and phosphorus was patented by SIEMENS in 1866, and by 1875, POURCEL was making 65% ferromanganese in a blast furnace. HADFIELD developed a wear-resistant steel containing manganese as an alloying agent in 1888. Ferromanganese was first produced in an electric arc furnace during 1890.

A two-stage process for the production of refined ferromanganese with 1–2% carbon was proposed in 1908, and manganese metal was first produced industrially by an aluminothermic process in 1898. In 1866 LECLANCHE filed a patent for the  $MnO_2-NH_4Cl-Zn$  dry-cell battery.

Table 47.1: Properties of manganese.

| Property                                  | $\alpha$ -Mn                          | $\beta$ -Mn                            | $\gamma$ -Mn                            | $\delta$ -Mn                            | Molten Mn                                     |
|---|---------------------------------------|--|---|---|---|
| Atomic number                             | 25                                    |  |   |   |   |
| Atomic mass                               | 54.938                                |  |   |   |   |
| Crystal structure                         | complex cubic                         | complex cubic                          | fcc                                     | bcc                                     |   |
| Lattice parameter, nm                     | 0.8894                                | 0.6290                                 | 0.3774                                  | 0.3080                                  |   |
| Transition temperature, °C                | $\alpha \leftrightarrow \beta$<br>727 | $\beta \leftrightarrow \gamma$<br>1095 | $\gamma \leftrightarrow \delta$<br>1104 | $\delta \leftrightarrow$ liquid<br>1244 | liquid $\leftrightarrow$ gas<br>2032          |
| Standard electrode potential, V           | 1.134                                 |  |   |   |   |
| Magnetic susceptibility, $m^3/kg$         | $1.21 \times 10^{-7}$                 |  |   |   |   |
| Density, $g/cm^3$                         | 7.44                                  | 7.29                                   | 7.21                                    |   | $7.55-1.2 \times 10^{-3} t$<br>(1244–1500 °C) |
| Brinell hardness, MPa                     | 3923–4119                             |  |   |   |   |
| Hardness, I scale                         | 5                                     |  |   |   |   |
| Volume increase on transition, %          | $\alpha \leftrightarrow \beta$<br>3.4 | $\beta \leftrightarrow \gamma$<br>0.8  | $\gamma \leftrightarrow \delta$<br>0.8  | $\delta \leftrightarrow$ liquid<br>2.9  |   |
| Resistivity, $\Omega cm$                  | $150-260 \times 10^{-6}$              | $90 \times 10^{-6}$                    | $40 \times 10^{-6}$                     |   |   |
| Compressibility, $m^2/N$                  | $8.4 \times 10^{-7}$                  |  |   |   |   |
| Coefficient of linear expansion, $K^{-1}$ | $22.3 \times 10^{-6}$                 | $24.9 \times 10^{-6}$                  | $14.8 \times 10^{-6}$                   | $41.6 \times 10^{-6}$                   |   |
| Latent heat of fusion, J/g                | 244                                   |  |   |   |   |
| Latent heat of vaporization, J/g          | 4020                                  |  |   |   |   |
| Heat of transition, J/mol                 | 2240                                  | 2282                                   | 1800                                    | 14 655                                  | 219 901                                       |
| Specific heat, $Jg^{-1}K^{-1}$            | 0.477                                 | 0.482                                  | 0.502                                   |   |   |
| Enthalpy, J/mol                           | 4999                                  |  | 5112                                    |   |   |
| Entropy, $Jmol^{-1}K^{-1}$                | 32.0                                  |  | 32.3                                    |   | 173.8   |

## 47.2 Properties [1–5]

Manganese is a silver-grey metal, resembling iron. It is hard and very brittle, and its primary uses in a metallic form are as an alloying, desulfurizing, and deoxidizing agent for steel, cast iron, and nonferrous metals. Due to its high tendency to oxidize, annealing colors are often evident.

Manganese belongs to group 7 and period 4 of the periodic table with an atomic number of 25 and atomic mass of 54.94. Six isotopes have been produced, of which only  $^{55}Mn$  is stable. The other isotopes,  $^{51}Mn$ ,  $^{52}Mn$ ,  $^{54}Mn$ ,  $^{56}Mn$ , and  $^{57}Mn$ , have half-lives ranging from 46 min to 310 d. Manganese exists in four allotropic forms:  $\alpha$ ,  $\beta$ ,  $\gamma$ , and  $\delta$ . Some important physical and thermodynamic properties are listed in Table 47.1. The vapor pressure of manganese in millibars is given by:

$$\log p = -13.625/T + 8.8837 \quad (770-885 \text{ }^\circ\text{C})$$

$$\log p = -13.994/T + 9.3360 \quad (957-1097 \text{ }^\circ\text{C})$$

$$\log p = -12.275/T + 8.3730 \quad (1250-1550 \text{ }^\circ\text{C})$$

and the molar heat capacity in  $Jmol^{-1}K^{-1}$  as a function of temperature by:

$$\alpha\text{-Mn (0.3–4.2 K):}$$

$$C_p = [16T + 2.39T^2 + 0.0266T^3] \times 10^{-3}$$

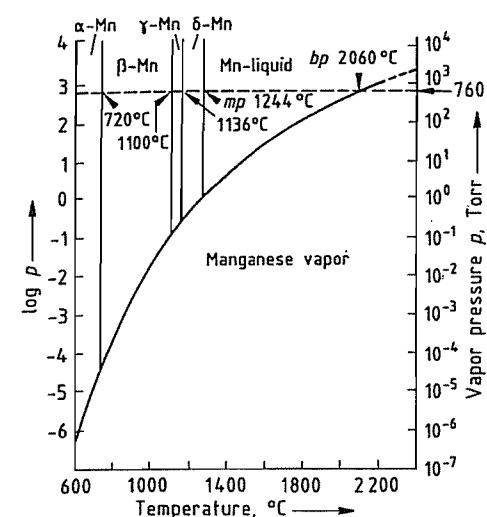

Figure 47.1: The vapor pressure of manganese [3].

$\alpha$ -Mn (298–1000 K):

$$C_p = 23.9 + 14.2 \times 10^{-3}T - 1.55 \times 10^{-5}T^2$$

$\beta$ -Mn (1000–1374 K):  $C_p = 34.9 + 2.765 \times 10^{-3}T$

$\gamma$ -Mn (1374–1400 K):  $C_p = 44.80$

$\delta$ -Mn (1410 K–mp):  $C_p = 47.31$

Liquid Mn (mp–bp):  $C_p = 46.06$

The vapor pressure diagram of manganese is shown in Figure 47.1.

Manganese exhibits certain similarities to its neighbors in the periodic table, iron and chromium. The electronic configuration is  $1s^2 2s^2 2p^6 3s^2 3p^6 4s^2$ .

Manganese occurs in all oxidation states between Mn(–III) and Mn(VII), with Mn(II) being the most stable. Trivalent manganese is less stable and readily disproportionates into Mn(II) and Mn(IV). The remaining oxidation states occur mainly in complexes.

The basicity of the oxides decreases with increasing valency of the manganese. Thus, manganese(II) oxide is the anhydride of a base  $Mn(OH)_2 \rightarrow MnO + H_2O$

while manganese(VII) oxide  $Mn_2O_7$  is an acid anhydride:

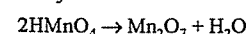

Manganese(IV) oxide ( $MnO_2$ ) is amphoteric. The oxidation states Mn(II) and Mn(VII) are of industrial importance, forming a large

number of useful salts. In metallurgy, oxides of di-, tri-, and tetravalent manganese are important, especially Mn(II) oxide.

At normal temperatures, pure manganese is not attacked by oxygen, nitrogen, or hydrogen. At high temperatures it reacts violently with oxygen, sulfur, and phosphorus. It is therefore a powerful agent for deoxidizing and desulfurizing metals, whereby it is converted to a divalent oxide or sulfide. Reaction with chlorine forms manganese(II) chloride; with  $SO_2$  the products are MnS and  $MnO$ .

Manganese dissolves in acids with liberation of hydrogen and formation of Mn(II) salts. Hot concentrated sulfuric acid dissolves manganese with evolution of  $SO_2$  and nitric acid with evolution of hydrogen, nitrogen, and dinitrogen monoxide.

## 47.3 Occurrence [5–12]

Manganese is the twelfth most abundant element in the earth's crust, at 950 ppm [5].

**Mineralogy.** Manganese is contained in many minerals, of which approximately 250 can be regarded as true manganese minerals. The major ores, generally with manganese contents above 35%, are hydrated or anhydrous oxides. The silicates and carbonates occur to a lesser extent. The major manganese minerals are listed in Table 47.2.

Table 47.2: Manganese minerals of economic importance.

| Mineral       | Formula                             | Theoretical Mn content, % | Relative density |
|---------------|-------------------------------------|---------------------------|------------------|
| Pyrolusite    | $\beta$ - $MnO_2$                   | 63.2                      | 5                |
| Braunite      | $Mn^{2+}Mn_3^{3+}SiO_{12}$          | 66.6                      | 4.7–4.9          |
| Manganite     | $\gamma$ - $MnOOH$                  | 62                        | 4.3              |
| Psilomelane   | $(Ba,Mn^{2+})_3(O,OH)_6 Mn_2O_{16}$ | 45–60                     | 4.4–4.7          |
| Cryptomelane  | $KMn_8O_{16}$                       | 62                        | 4.3              |
| Hausmannite   | $Mn_2MnO_4$                         | 73                        | 4.7–5.0          |
| Jacobsite     | $Fe_2MnO_4$                         | 23.8                      | 4.8              |
| Bixbyite      | $(Mn,Fe)_2O_3$                      | 30–40                     | 5                |
| Rhodonite     | $(Mn,Fe,Ca)SiO_3$                   | 42                        | 3.4–3.6          |
| Rhodochrosite | $MnCO_3$                            | 47.6                      | 3.3–3.6          |
| Bementite     | $Mn_3Si_2O_5(OH)_4$                 | 43.2                      | 3.5              |

Economically significant manganese deposits are all of sedimentary origin, having been dissolved from crystalline rocks and deposited as the oxide, hydroxide, or carbonate.

Wad is the term given to the soft, earthy, hydrous mixture of manganese and iron oxides of variable manganese content.

**Ore Quality.** Typically, only ores containing a minimum of 35% Mn are regarded as manganese ores. Ores containing 10–35% Mn are categorized as ferruginous manganese ores, and iron ores with 5–10% Mn are referred to as manganiferous ores. The three most important areas of application of manganese ores and the specific requirements, are as follows:

- Metallurgical grade ore for the iron and steel industry, which generally contains 38–55% Mn. The phosphorus content should preferably be below 0.1%, and the concentrations of  $Al_2O_3$ ,  $SiO_2$ , CaO, MgO, and S are important. The manganese/iron ratio is critical; a 7.5:1 ratio, for example, is required for a standard ferromanganese alloy with 78% Mn.
- Battery-grade ore, containing 70–85%  $MnO_2$  (44–54% Mn). The ore should generally contain less than 0.05% of metals more electronegative than zinc, such as copper, nickel, cobalt, and arsenic. The suitability of manganese dioxide for use in batteries depends on a number of factors, including the crystal structure, surface area, pore size distribution, particle shape and size, electrical conductivity, surface conditions, chemical composition, and structure defects [2].
- Chemical grade ore whose specifications vary considerably depending on the end use. Included in this category are feed stocks for electrolytic manganese and manganese dioxide, manganese chemicals, colorants and, in South Africa, an oxidant in uranium extraction.

**Ore Deposits.** The most important manganese ore deposits are located in South Africa, the former Soviet Union, Australia, Gabon in West Africa, and Brazil. The deposits in India and Mexico are of declining importance, and

the majority of the production is consumed domestically.

The largest known land-based manganese deposit is the Kalahari Field, located in the Northern Cape Province of South Africa, which contains ca. 78% ( $13\,600 \times 10^6$  t) of the world's potential resources. The surface area underlain by this deposit is approximately 320 km<sup>2</sup>. The deposit is sedimentary and interlayered with banded ironstone.

A breakdown of the world's total estimated manganese ore reserves is presented in Table 47.3.

Each of the major manganese producers offers a range of ore products, the detailed chemical and physical characteristics of which are given in [8]. Analyses of some typical commercial grades are presented in Tables 47.4 and 47.5.

Another potentially important source of manganese are the deep-sea nodules located over certain areas of the ocean floor.

## 47.4 Mining and Beneficiation

The methods employed for the mining and beneficiation of manganese ore vary widely depending on the size and nature of the deposit, ore type, end uses, and size of the operation.

**Mining.** The major producers of manganese ore utilize both underground and open-cast mining techniques. In South Africa, Samancor extracts ore from the open-cast Mamatwan Mine and the underground Wessels Mine. At Mamatwan the ore body attains a maximum thickness of 45.2 m and is overlain by, on average, 45 m of overburden. The open pit is approximately 1900 m by 300 m, and the ore is extracted from three benches by drilling, blasting, loading, and hauling to an in-pit crusher. At Wessels the ore body is located at a depth of ca. 300 m and a room and pillar mining system is employed. The average stope height is ca. 5 m, and the ore is drilled, blasted, loaded, and hauled to underground primary crushing facilities.

Table 47.3: Manganese reserves and production (1995).

|                                    | Ore reserves,<br>10 <sup>6</sup> t | Ore production,<br>10 <sup>3</sup> t | High-carbon ferromanganese production,<br>10 <sup>3</sup> t* | Silicomanganese production,<br>10 <sup>3</sup> t |
|------------------------------------|------------------------------------|--------------------------------------|--|--|
| <i>Ore-producing countries</i>     |                                    |                                      |  |  |
| South Africa                       | 13 600                             | 3 040                                | 433  | 266  |
| Former Soviet Union                | 2 300                              | 4 000                                | 292  | 807  |
| Gabon                              | 400                                | 1 930                                |  |  |
| Australia                          | 400                                | 2 169                                | 93   | 94   |
| Brazil                             | 160                                | 2 500                                | 142  | 230  |
| China                              | 100                                | 3 700                                | 550  | 524  |
| India                              | 60                                 | 1 700                                | 191  | 100  |
| Others                             | 90                                 | 1 347                                |  |  |
| <i>Non-ore-producing countries</i> |                                    |                                      |  |  |
| Germany                            |                                    |                                      |  |  |
| Japan                              |                                    |                                      | 398  | 82   |
| Mexico                             |                                    |                                      | 78   | 65   |
| Norway                             |                                    |                                      | 233  | 210  |
| United Kingdom                     |                                    |                                      |  |  |
| France                             |                                    |                                      | 437  | 89   |
| Others                             |                                    |                                      | 589  | 522  |
| <b>Total</b>                       | <b>17 110</b>                      | <b>20 386</b>                        | <b>3436</b>  | <b>2989</b>                                      |

\* Includes medium carbon ferromanganese production.

Table 47.4: Typical composition of some important metallurgical manganese ores (chemical content on % dry basis).

| Producer                  | Product              | Mn    | Fe      | P         | SiO <sub>2</sub> | Al <sub>2</sub> O <sub>3</sub> | CaO     | MgO     |
|---------------------------|----------------------|-------|---------|-----------|------------------|--------------------------------|---------|---------|
| Samancor, South Africa    | Mamatwan Lumpy       | 37–38 | 4–6     | 0.04      | 4–6              | 0.5                            | 14–16   | 4       |
|                           | Mamatwan Ferruginous | 32–34 | 4–6     | 0.04      | 4–6              | 0.5                            | 14–16   | 5       |
|                           | Wessels High Grade   | 50–51 | 9–11    | 0.05      | 5–7              | 0.5                            | 4–6     | 1.5     |
|                           | Wessels Low Grade    | 38–40 | 18–20   | 0.05      | 5–7              | 0.5                            | 4–6     | 2       |
| Groote Eylandt, Australia | Metallurgical Lump   | 49    | 2.5     | 0.06      | 6                | 4                              | 0.05    | 0.1     |
|                           | Siliceous Lump       | 44    | 2.5     | 0.06      | 15               | 4                              | 0.05    | 0.1     |
| Amapa, Brazil             | Bitolado 48          | 48–49 | 5.5–6.9 | 0.08–0.11 | 2–3              | 3.7–5.5                        |         |         |
|                           | Carbonate Grosso     |       | 2.5–4   | 0.04–0.10 | 10–14            | 2.0–3.8                        | 3.3–5.2 | 2.2–4.5 |
| CVRD, Brazil              | Lumpy                |       | 3.7     | 0.08      | 3.6              | 9.8                            | 0.25    | 0.3     |
| Comilog, Gabon            | Gabon Lumpy          |       | 3–5     | 0.11–0.14 | 2.5–4            | 6                              | 0.11    | 0.07    |
| Chiatura, Georgia         | Chiatura Average     | 31    | 1.5     | 0.62      | 22.2             | 2.27                           | 5.18    |         |

Table 47.5: Typical composition of some important battery-grade manganese ores (chemical content on % dry basis).

| Producer       | MnO <sub>2</sub> | Mn   | Fe  | Pb    | Cu    | Ni    | As    | Co    |
|----------------|------------------|------|-----|-------|-------|-------|-------|-------|
| CVRD, Brazil   | 76.5             | 51.0 | 3.2 | 0.035 | 0.050 | 0.080 | 0.004 | 0.035 |
| Comilog, Gabon | 83.6             |      | 1.8 |       | 0.03  | 0.05  |       | 0.095 |

At Groote Eylandt, BHP operates Australia's only manganese mine by open-cut methods from various quarries, each limited to an area ca. 250 m long by 60 m wide and normally having a single bench [15].

The former Soviet Union's primary manganese source is the Nikopol field, where the thickness of the ore seam is 1.5–2.5 m on average occurring at a depth of 100–120 m. A combination of underground and open-cut mining methods are employed [16].

**Beneficiation.** Ore treatment varies from simple crushing, washing, and sizing plants to fairly sophisticated beneficiation techniques. Gravity separation techniques are frequently employed, such as the dense-medium separation plants at Groote Eylandt and Mamatwan. Extensive investigations on a pilot-plant scale have been undertaken by Samancor on ore sorting techniques, based on neutron activation or X-ray fluorescence; this has not as yet led to a commercial operation. Froth flotation

with fatty acids, amines, sulfates, sulfonates, and hydroxamates has been shown to be feasible on a laboratory scale [17], as have high-gradient magnetic separation techniques [18].

Beneficiation techniques are becoming progressively more complex as reserves of high-grade ores diminish and requirements for smelting and steelmaking become more stringent.

**Intermediate treatment processes.** Various intermediate treatment processes can be applied to manganese natural ores or concentrates prior to smelting to a ferroalloy or direct addition to a steelmaking process. These processes are employed for one or both of the following two reasons: 1) to convert a fine ore to a more suitable size, and 2) to calcine and/or reduce the ore to a more suitable final product.

Agglomeration processes include nodulizing, pelletizing, and briquetting. Reduction can be carried out in a rotary kiln or sinter plant.

Sintering has become the preferred process for intermediate treatment, and approximately ten manganese sinter plants currently exist, with sintering grate areas varying from 3 m<sup>2</sup> to 80 m<sup>2</sup> and production capacities of 2–300 t/h.

Sinter is produced on a moving grate from a mixture of fine ore, fine reductant/fuel, and recycled sinter fines. The fuel in the bed is ignited, and ignition is propagated by applying suction to the grate. A sufficiently high temperature is generated to fuse the ore particles together. During sintering, the ore is calcined and partially reduced. Some of the benefits derived from sintering ore are:

- Fine ore, which has a limited application and value in conventional smelting, is agglomerated and converted to a superior product.
- Reduced gas volumes, and hence fewer furnace eruptions, result when smelting sinter.
- Furnace availability and operating loads are increased.

## 47.5 Reduction of Manganese Oxides<sup>1</sup>

Manganese is only produced commercially from blends of ore in which manganese exists as an oxide. A knowledge of the thermodynamics of the reduction of these oxides [19] is therefore essential to the understanding of the production of alloys from manganese ores.

### 47.5.1 Manganese–Oxygen System

Of the known oxides of manganese (Mn<sub>2</sub>O<sub>7</sub>, MnO<sub>2</sub>, Mn<sub>5</sub>O<sub>8</sub>, Mn<sub>2</sub>O<sub>3</sub>, Mn<sub>3</sub>O<sub>4</sub>, and MnO), the only oxides found naturally in manganese ores are MnO<sub>2</sub>, Mn<sub>2</sub>O<sub>3</sub>, Mn<sub>3</sub>O<sub>4</sub>, and MnO.

Under normal conditions, manganese dioxide occurs as stable β-MnO<sub>2</sub>; the other modifications, α, γ, δ, and ε, are not pure varieties of MnO<sub>2</sub>. Dimanganese trioxide (Mn<sub>2</sub>O<sub>3</sub>) exists in the α-modification, which is cubic above 20 °C and rhombic below this temperature; the γ-modification is metastable. Trimanganese tetroxide (Mn<sub>3</sub>O<sub>4</sub>) exists at atmospheric pressure in the tetragonal α-modification and changes to the cubic β-form at 1170 °C. Manganese oxide (MnO) in normal conditions exists in only one modification. This oxide is, however, nonstoichiometric and is more accurately described as Mn<sub>1-x</sub>O with x = 0–0.25 [20]. The complete phase diagram of the manganese–oxygen system above 1000 °C is given in Figure 47.2.

The equations for the thermal dissociation of the important manganese oxides are as follows:

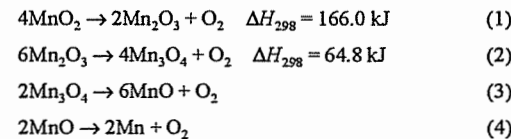

The oxygen partial pressures exerted by these reactions are given as a function of temperature in Figure 47.3 [21]. According to the

<sup>1</sup> For Ferromanganese, see Section 7.4.

thermodynamic data in [22], the decomposition temperature at 101.3 kPa for reaction (1) is 500 °C and for reaction (2), 980 °C. For reaction (3) to occur at atmospheric pressure a reductant is necessary. Reaction (4) requires a high reducing potential. It is important, therefore, to consider the reduction of the oxides of manganese in the presence of carbon monoxide, hydrogen, and carbon. These are the reactions that usually take place in the blast furnaces and electric furnaces used to produce manganese alloys.

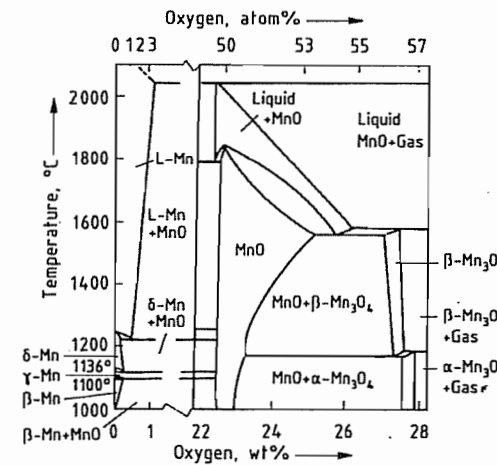

Figure 47.2: Mn–O phase diagram above 1000 °C.

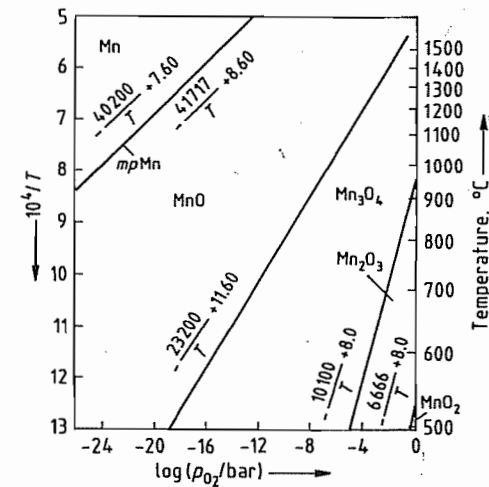
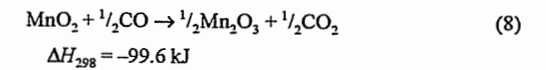
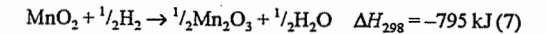
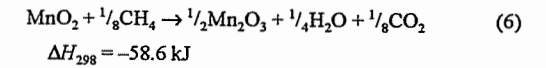
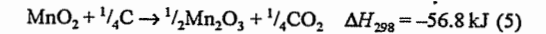

Figure 47.3: Variation of oxygen partial pressure in the Mn–O system with temperature.

### 47.5.2 Reduction of Manganese Oxides with Carbon Monoxide, Hydrogen, and Carbon

The reduction of MnO<sub>2</sub> to Mn occurs in four main steps (Equations 1–4). This reduction is strongly exothermic in the presence of carbon, methane, and carbon monoxide; the following equations apply:



The reduction of Mn<sub>2</sub>O<sub>3</sub> in the presence of the same reducing agents is also exothermic. The following equations apply:

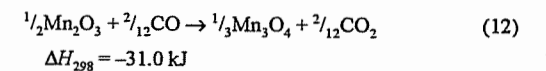
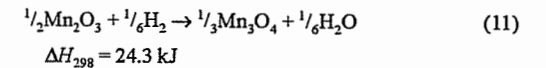
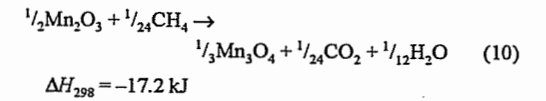
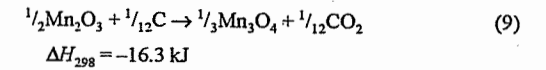

The third step is the reduction of Mn<sub>3</sub>O<sub>4</sub>, which is endothermic with carbon or methane and exothermic with hydrogen or carbon monoxide:

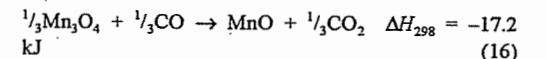
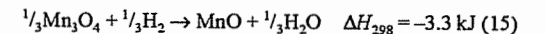
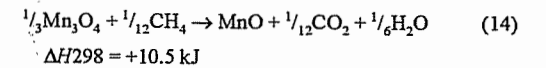
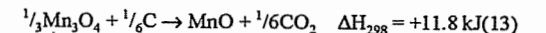

The last step, the reduction of MnO, is more difficult and requires a high reducing potential. The presence of carbon is therefore necessary and at a carbon monoxide partial pressure of 101.3 kPa a temperature of 1420 °C is necessary for the reaction to pro-

ceed. However, the formation of manganese carbides in the presence of carbon lowers the reaction temperature to 1300 °C. The following, highly endothermic overall reaction applies:

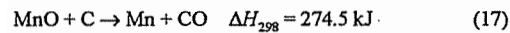

This reaction can be broken down into

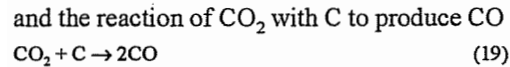

which ensures that a high reducing potential is maintained.

Due to the importance of both carbon monoxide and carbon as reducing agents in the commercial production of manganese-containing alloys, these are discussed in more detail. It is possible to predict the ratio  $\text{CO}/\text{CO}_2$  that will reduce the individual manganese oxides by considering the relationship between the oxygen partial pressures and the equilibrium constants for the reactions (1–4)

$$K_{p(1-4)} = p_{\text{O}_2} \quad (20)$$

(assuming that the activities of the solid phases are unity) and the equilibrium constant of the reaction



which is

$$\frac{1}{K_p} = \frac{p_{\text{CO}}^2 \cdot p_{\text{O}_2}}{p_{\text{CO}_2}^2} \quad (22)$$

and the relationships

$$G^0 = -RT \ln K_p \quad (23)$$

and

$$G^0 = -RT \ln p_{\text{O}_2} \quad (24)$$

the oxygen potentials of the individual reactions at various temperatures can be calculated. This is shown graphically in the Richardson diagram [21] (Figure 47.5). The same applies to the use of hydrogen as a reductant. Although the reduction of  $\text{MnO}_2$ ,  $\text{Mn}_2\text{O}_3$ , and  $\text{Mn}_3\text{O}_4$  takes place at low partial pressures of  $\text{CO}$ , the presence of carbon is necessary for the reduction of  $\text{MnO}$ . In this case the following reaction is important:



for which

$$\log p_{\text{O}_2} = -11 \, 672/T - 9.16 \quad (26)$$

This reaction is pressure dependent due to the change in the number of moles of gas, and again the Richardson diagram can be used to predict under which conditions the reduction of  $\text{MnO}$  will occur (Equations 17, 18, and 19). However, manganese carbides are always formed during the reduction of  $\text{MnO}$  with carbon, and this lowers the temperature at which the reaction occurs.

The products produced in this process always contain carbon. The phase diagram for the manganese-carbon system is shown in Figure 47.4. The melting point increases with increasing carbon content [23]. Commercial ferromanganese (76% Mn, 16% Fe) contains ca. 7% carbon. The solubility of carbon decreases with increasing silicon content.

### 47.5.3 Reduction of Mixed Oxides and Minerals Containing Manganese Oxides

In the discussion of the reduction of manganese oxides it has been assumed that the activity of the solid phases is unity. However, this is usually not true in practice because in most manganese ores the manganese oxides are combined with iron oxides, silicates, aluminum oxides, calcium oxides, and phosphorus oxides.

The oxides  $\text{FeO}$  and  $\text{P}_2\text{O}_5$  are reduced at lower temperature than  $\text{MnO}$ , and  $\text{SiO}_2$  at only slightly higher temperature (Figure 47.5). Any iron oxides and oxides of phosphorus occurring in the ore, fluxes, and reductants used in commercial processes are reduced together with the manganese oxides and report to the product. A judicious choice of ores and raw materials is therefore necessary to limit the amount of these elements which report to the metal. The silica contained in the ores can also be reduced, and in the production of silicomanganese this is desirable. Quartz or quartz-

ite is therefore an important raw material for the production of silicomanganese.

The presence of other oxides in the ores reduces the activity of the manganese oxide. This must be compensated for by increasing the reducing potential by increasing the  $\text{CO}/\text{CO}_2$  ratio of the gas mixture. Alternatively, the reduction temperature must be increased if the reaction is carried out with carbon.

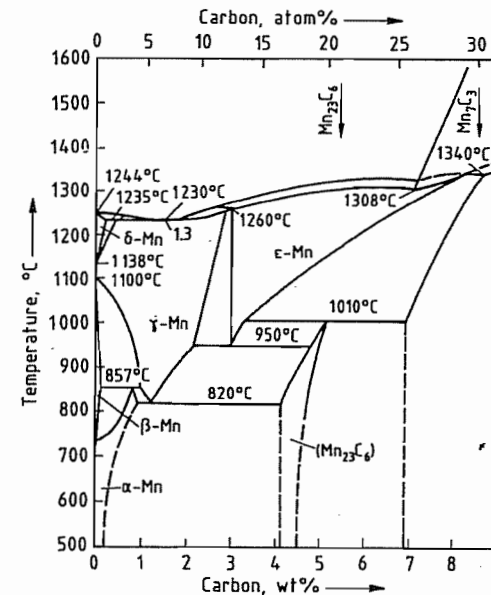
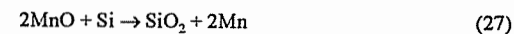

Figure 47.4: Phase diagram for the Mn-C system [23].

### 47.5.4 Reduction of Manganese Oxides by Silicon

Figure 47.5 shows that the reduction of manganese(II) oxide by silicon is also possible:



for which

$$K = \frac{a_{\text{SiO}_2} \cdot a_{\text{Mn}}^2}{a_{\text{MnO}}^2 \cdot a_{\text{Si}}} \quad (28)$$

This reaction is the basis of the Frisch process for the production of low-carbon ferromanganese and manganese metal from silicomanganese. The silicon content of the metal is

restricted by using a basic slag that reduces the activity of  $\text{SiO}_2$  by reaction with  $\text{CaO}$ , displacing reaction (27) as far to the right as possible.

### 47.5.5 Reduction of Manganese Oxide by Aluminum

It is easier to reduce manganese(II) oxide with aluminum than with silicon because the differences in the oxygen potentials of the dissociation equilibria of  $\text{MnO}$  and  $\text{Al}_2\text{O}_3$  are greater than for  $\text{MnO}$  and  $\text{SiO}_2$  (Figure 47.5). As in the case of carbon and silicon, the higher oxides of manganese are also reduced if present in the ore. The aluminothermic process is used in the production of manganese metal (see Section 47.6.3).

### 47.6 Production of Manganese Metal [24, 25]

Pure manganese metal has only become an important commodity since ca. 1940. Today the world market is in excess of  $140 \times 10^3$  t/a. Most of the high-purity manganese produced is consumed by the steel and aluminum industries, although the use of manganese for the production of manganese zinc soft ferrites has led to a demand by electronic component producers [26]. Whilst ferromanganese remains an economically sound additive for manganese steel producers, greater volumes of pure manganese metal are used in the formulation of specialty steels.

In aluminum production, manganese powder is added to the melt to make the product harder. Manganese powder has long been used in welding-rod fluxes, where it imparts superior flow properties to the melt forming the weld.

Producers of manganese chemicals enjoy the convenience of a pure, reactive starting material from which to manufacture manganese salts and compounds.

A number of methods for the production of relatively pure manganese metal are known:

- Electrolysis of aqueous manganese salts

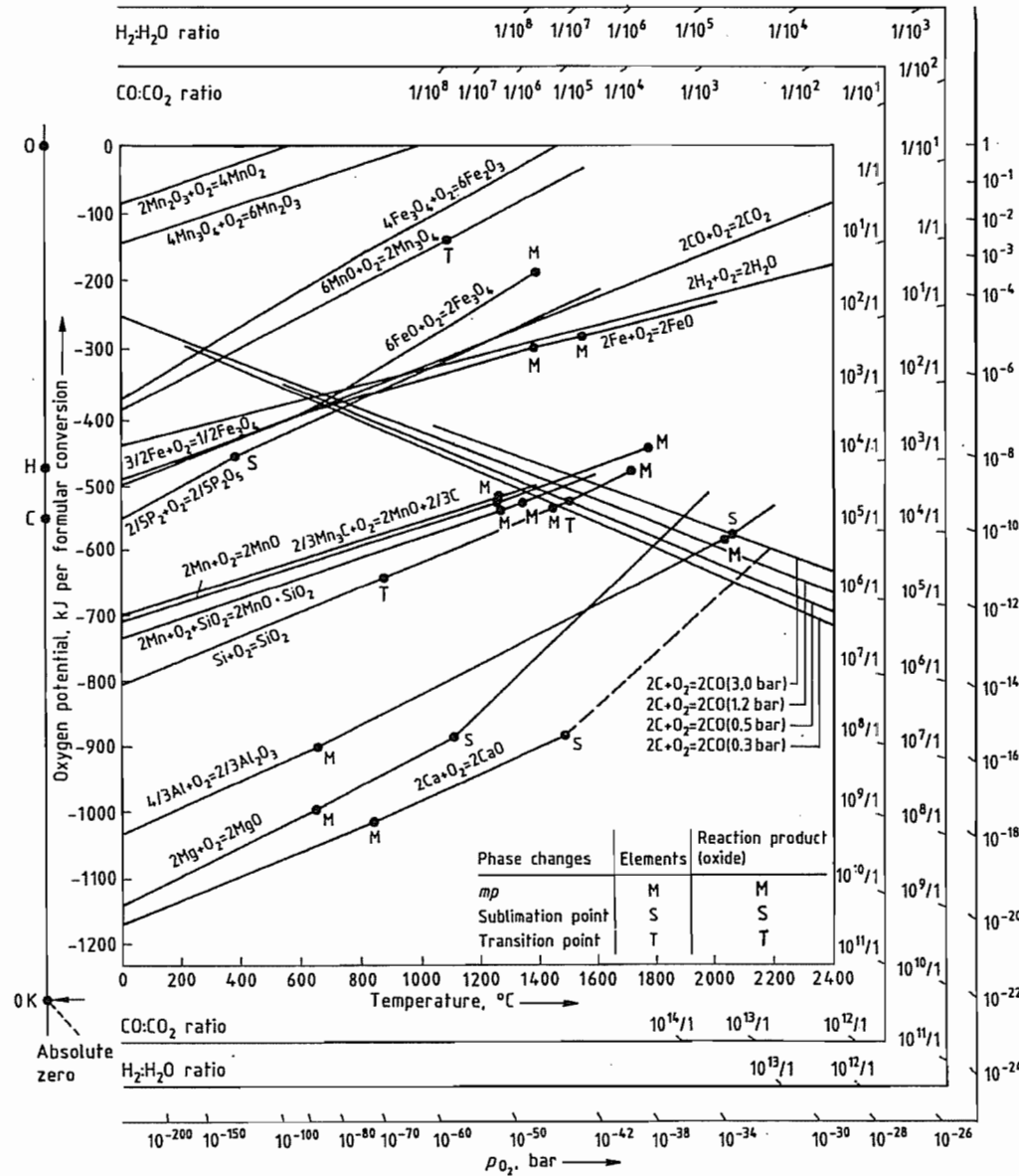

Figure 47.5: Temperature dependence and oxygen potentials of oxide systems [21].

- Electrothermal decomposition of manganese ores
  - Silicothermic reduction of manganese ores or slags
  - Aluminothermic reduction of manganese ores or slags
  - Distillation of ferromanganese
  - Electrolysis of fused salts
- The first two techniques are the most important.

### 47.6.1 Electrolysis of Aqueous Manganese Salts

The electrolytic route to manganese metal was first investigated in 1930 by DAVIS. However, the process did not become significant until 1939 when demand for manganese by the steel producers (for armaments manufacture) prompted the U.S. Bureau of Mines to build a 1 t/a pilot plant at Knoxville, Tennessee. The plant was redesigned in 1940, and by 1944 it was producing ca. 1500 t/a. Chuo Denki Kogio of Japan commenced production in 1941. The U.S. Bureau of Mines built a second pilot plant at Boulder City in 1942 [27], and The Electrolytic Manganese Corporation of Krugersdorp, South Africa began production in 1955.

The Boulder City process forms the basis of modern electrolytic manganese plant operation and is encountered in many parts of the world. Production capacities according to country and company are listed in Table 47.6.

Table 47.6: Estimated production capacity for electrolytic manganese metal, 1988 [59].

| Company                      | Country             | Capacity, t   |
|------------------------------|---------------------|---------------|
| Fermavi Industria e Comercio | Brazil              | 80            |
| Chuo Denki Kogio             | Japan               | 3 600         |
| Tosoh                        | Japan               | 6 000         |
| Manganese Metal Company      | RSA                 | 43 300        |
| Elkem Metals                 | United States       | 10 000        |
| Kerr-McGee Chemicals         | United States       | 11 250        |
| State Organization           | Former Soviet Union | 3 000         |
| <b>Total</b>                 |                     | <b>77 230</b> |

The Manganese Metal Company of South Africa is currently the largest supplier but high prices in the late 1980s have encouraged investment by other countries. The process may be conveniently divided into 3 stages:

- Milling and chemical reduction of a suitable ore
- Leaching of the soluble manganese and removal of deleterious solutes
- Electrowinning of manganese metal

**Ore Milling and Reduction.** To ensure reactivity in both the reduction and leaching steps,

the ore is milled to ca. 80–90% < 75 μm [28]. The surface area (BET) is 2–5 m<sup>2</sup>/g. It is usual to dry mill the ore since the hydrometallurgical part of the process is closed and unnecessary dilution of the liquor must be avoided. Ball or vertical spindle mills are suitable for this purpose. Transport of the ore may be effected pneumatically at this stage.

Manganese ores usually occur in an insoluble form comprising minerals largely in the 4+ oxidation state. Carbonate ores, which are readily soluble, occur in some parts of the world. To render refractory ores soluble in acid, the manganese is usually converted to the 2+ oxidation state by calcining under a reducing atmosphere at 850–1000 °C. Reductants are carbon sources and may include various combinations of anthracite, coal, charcoal, hydrocarbon oils, natural gas, coal gas, or liquefied petroleum gas. The reduction reactions can be simplified to:

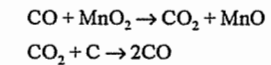

Other species present are also reduced. Iron is reduced to the iron(II) state and in some cases to iron metal. The Fe(II) content of the calcined ore may be used as an indicator of the degree of reduction achieved; a calcine containing 1–3% Fe(II) can be assumed to have its manganese fully reduced to Mn(II).

The discharging calcined ore must be cooled to below 100 °C to exclude the possibility of reoxidation. The reactive nature of the calcine at this stage precludes pneumatic transport.

Reductive leaching has been investigated with bacteria [29] and with reducing chemicals such as sulfur dioxide, hydroquinone, and other organic compounds [30].

**Leaching and Purification.** The reduced ore is agitated with spent electrolyte which normally contains 2–5% sulfuric acid (generated at the diaphragm in the electrolysis stage). Other soluble species, notably iron(II), are also dissolved and must be removed prior to electrolysis. The pH of the leachate should be 5–6, and air oxidation of Fe<sup>2+</sup> to Fe<sup>3+</sup> ensures the precipitation of iron(III) hydroxide to re-

move soluble iron [31]. Other deleterious transition metals are removed by precipitation of their sulfides through pH manipulation and addition of a soluble sulfide [32]. Some manganese sulfide is necessarily coprecipitated during this process and the relative amount of this present in the sulfide precipitate is a measure of the efficiency of the reaction [33–36]. The manganese concentration at this point is ca. 10% expressed as the sulfate. If a substantial amount of soluble silica is present, it may be removed by coprecipitation with aluminum hydroxide. A solid-liquid separation is required to provide a perfectly clean solution for the electrolytic stage. Other current methods of purification include ion exchange and solvent extraction [37, 38].

**Electrowinning of Manganese Metal.** Although manganese has a strongly electronegative electrode potential (–1.13 V), its high hydrogen overvoltage allows electrowinning from aqueous solutions. Good current efficiencies are only obtained when other metallic solutes are absent from the catholyte.

The manganese is recovered in a diaphragm cell. The cathode may be made of titanium, stainless steel, or one of a number of proprietary alloys. The anode is usually a lead calcium or lead-silver alloy, but success has recently been achieved with anodes coated with platinum-group metals. Diaphragms are usually made of synthetic polymer canvas.

Prior to introduction to the cell, the solution is conditioned by addition of sulfur dioxide or, more recently, selenium dioxide [39]. These additives improve current efficiencies and ensure the deposition of the hard and brittle  $\alpha$  allotrope of manganese. It has been reported that the current efficiencies have been increased to as much as 90% with selenium dioxide. However, the latter has the disadvantage that the metal obtained is often contaminated with selenium. This reduces the total manganese content of the metal and causes toxicological and environmental problems for the consumer. Addition of sulfur dioxide produces a metal with slightly higher sulfur content. Ammo-

niun sulfate is used in the cell solution as a supporting electrolyte.

Typical cell operating conditions at the cathode are as follows:

|   |                       |
|---|-----------------------|
| MnSO <sub>4</sub> concentration                               | 4.0%                  |
| (NH <sub>4</sub> ) <sub>2</sub> SO <sub>4</sub> concentration | 13%                   |
| pH  | 7.0                   |
| Temperature   | 35–45 °C              |
| Current densities:  |                       |
| Anode   | 1000 A/m <sup>2</sup> |
| Cathode   | 500                   |
| Potential   | 5–7 V                 |

These values are approximate and vary considerably between installations. Current efficiencies are variable, depending on additives, the purity of the catholyte, and optimization of solute concentrations. Values between 42 and 62% are typical.

The following reactions occur [40]:

At the cathode

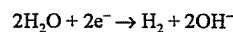
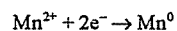

At the diaphragm

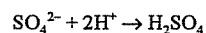

At the anode

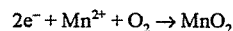
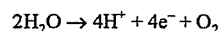

The electrolysis of water is largely responsible for the inefficiency of the electrolytic procedure. Power consumption is typically 9000–12 000 kWh/t. Polymeric smoothing agents may be added to the electrolyte to prevent the formation of dendrites and nodules on the cathodes, which usually cause the metal to be of inferior quality. Deposition time is dependent on current densities and varies between 12 and 30 h. Current efficiencies tail off rapidly as the thickness of the metal increases, and a compromise must be made between high efficiencies and the production of the thick metal flake required by the market. A thickness of 1.5–2.0 mm is considered optimum.

**Metal Treatment.** The cathodes are removed from the electrolysis bath after the appropriate deposition period. Since the  $\alpha$ -manganese deposited is hard and brittle, it is readily stripped from the cathode starter-sheet by mechanical shock. The metal is then washed and dried.

Absorbed hydrogen is removed by heating in air or under an inert atmosphere. The latter is necessary when manganese with a particularly low oxygen content is required. Metal destined to be milled must have hydrogen content < 0.0005% to minimize the explosion risk. A primary hydrogen explosion can initiate a secondary manganese dust explosion.

The metal is sold in flake, powder, or granular forms, depending on the end use. A generalization is that the steel industry requires thick flake, while the aluminum industry, welding-rod manufacturers, and manganese chemical producers require powders of various particle size distributions.

Other forms of manganese are also encountered; for example, powder and flake manganese which has had its surface passivated by mild oxidation. A market exists for briquettes of manganese and iron, or manganese and aluminum, which are conveniently added to melts of the appropriate metal to produce a particular alloy.

**Quality Control and Analysis.** Electrolytic manganese metal has a purity of > 99.5%; no reliable method exists to determine manganese content directly. The sum of the impurities is therefore deducted from 100% to obtain the assay of the metal.

A typical analysis (%) is:

|           |        |
|-----------|--------|
| Manganese | 99.8   |
| Oxygen    | 0.2    |
| Nitrogen  | 0.005  |
| Sulfur    | 0.02   |
| Carbon    | 0.001  |
| Iron      | 0.001  |
| Copper    | 0.001  |
| Cobalt    | 0.001  |
| Nickel    | 0.001  |
| Selenium  | 0.0005 |
| Hydrogen  | 0.0006 |

When selenium dioxide is used as a cell solution additive, typical values (%) are:

|           |      |
|-----------|------|
| Manganese | 99.4 |
| Sulfur    | 0.01 |
| Selenium  | 0.3  |

Analytical methods described in this section are applicable to all types of manganese metal.

In large amounts, manganese is best determined by titration and many methods exist.

The most reliable is the titration of the divalent ion with permanganate in a neutral pyrophosphate buffer that stabilizes the trivalent manganese species. A platinum redox indicator electrode is used with a suitable reference electrode. A microprocessor controlled automatic titrator facilitates precision and accuracy. The reaction can be summarized as:

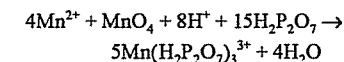

The equivalence potential is ca. 0.47 V versus the saturated calomel electrode.

An alternative is to oxidize the manganese to permanganate with excess sodium bismuthate in the presence of nitric acid, add an excess of standard iron(II) solution and back-titrate with permanganate. This method has the advantage of not requiring sophisticated endpoint detection equipment but suffers from a number of interferences. Variations on this oxidation/titration method include silver-catalyzed oxidation by persulfate followed by an arsenate titration [41].

Metallic impurities in both metal and process liquors are usually determined by absorption or emission spectroscopy, though various voltammetric techniques have been used to determine traces in pure metals. The half wave potential of manganese is –1.57 V versus the saturated calomel electrode, making anodic stripping voltammetry ideally suitable for trace metal determination.

Nonmetallic impurities are universally determined by the use of commercially available equipment. The metal is usually heated above the melting point, in a gas stream, releasing the sought element in the form required. This is then determined in the gas phase by infrared absorption or thermal conductivity detectors. Nitrogen in greater than trace amounts has been determined by acid digestion, distillation, and colorimetric determination of ammonia (cf. Kjeldahl method for ammonia).

**Summary.** The electrolysis of aqueous solutions is the most important manufacturing route at present to high-purity manganese. Economic efficiencies are dependent on scrupulously clean solutions and strict control of

operating parameters. The metal produced may be > 99.7% pure and has many varied uses.

Manganese has also been produced by the electrolysis of aqueous solutions at a flowing mercury cathode. This process, which operates at high current efficiencies, can deliver the manganese in a variety of forms, and is less dependent on solution purities. High electrolysis temperatures, and the inconvenience of coping with toxic mercury are possible reasons why there are now no full-scale plants using this process.

#### 47.6.2 Electrothermal Process

This practice is a refinement of the silico-thermic reduction of manganese (see below). However, the purity of the product obtained from the electrothermal process is superior.

The production of bulk manganese by this method is a well protected secret and little information appears in the literature. It is essentially a multistage hot refining process based on the following principles. Manganese ore is smelted in an arc furnace with a limited amount of reductant. This preferentially reduces the iron to metal with a small amount of manganese to form a low-grade ferromanganese with a high phosphorus content. The slag is thus refined to a purified manganese starting material.

The slag is used to produce a high-silicon silicomanganese (> 30% Si) to ensure a low carbon content. Other ingredients such as quartz, limestone, and coke must be selected carefully to ensure a low contamination level. Coke, in particular, may have to be produced from special low-phosphorus coals.

The liquid silicomanganese is treated in two steps, with a liquid basic slag made from the purified manganese starting material. The operation is carried out in a ladle or a shaking ladle.

Typical analyses of electrothermal manganese are given in Table 47.7. From these analyses it can be seen that electrothermic manganese is a relatively pure product that competes in some areas with electrolytic man-

ganese. The sulfur content is particularly low. The aluminum industry is experimenting the use of these products as alternatives to electrolytic manganese.

Table 47.7: Typical analyses of electrothermal manganese.

|            | Gimel* A | Gimel F | Gimel BF | Gimel LP |
|------------|----------|---------|----------|----------|
| Mn (% min) | 96       | 97      | 98       | 97       |
| C (% max)  | 0.050    | 0.030   | 0.030    | 0.030    |
| Si (% max) | 0.50     | 0.30    | 0.30     | 0.30     |
| P (% max)  | 0.050    | 0.030   | 0.030    | 0.020    |
| S (% max)  | 0.008    | 0.008   | 0.008    | 0.008    |
| Fe (% max) | 3.0      | 2.0     | 1.5      | 2.0      |
| H (ppm)    | 5        | 5       | 5        | 5        |
| N (max)    | 0.035    | 0.035   | 0.035    | 0.035    |

\*Gimel is a registered trade mark of Pechiney Électrometallurgie.

#### 47.6.3 Aluminothermic Process

This production route is based on the well known thermite reaction in which a reactive metal liberates a less reactive metal from its oxide with the evolution of heat. The reactions possible for manganese oxides are:

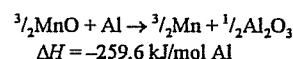
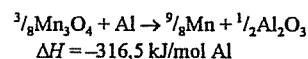
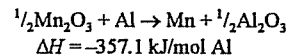
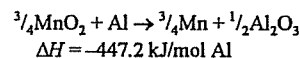

A heat of reaction of between 272 and 314 kJ/mol aluminum is necessary to sustain the reaction and ensure that it is not explosive. Therefore, some ores may require modification of the relative proportions of the different manganese oxides prior to reaction. This is achieved by calcination at ca. 1000 °C. Certain circumstances require reduction of the ore by calcining in a reducing atmosphere.

Calcium oxide is added to the mix to improve the flow properties of the slag, ensuring good separation of slag and metal. Lime also decreases the amount of silica reporting to the metal phase.

The aluminothermic route to manganese production is attractive in that it requires simple technology which is well documented, and

low capital investment. Its disadvantages are that aluminum is expensive, and the exhaust gases from the process carry manganese and aluminum dust into the atmosphere. Efficiencies of up to 87% have been reported.

#### 47.6.4 Silicothermic Process

The production of manganese by silico-thermic reduction resembles that of low-carbon ferromanganese in electric arc furnaces of 1–3 MW power consumption [42, 43]. The raw material used is either low-iron manganese ore or a manganese slag concentrate. The silicon is in the form of a special silicomanganese with ca. 33% Si and < 3% Fe. It is made from a manganese slag concentrate or from pure ores. Reduction as complete as possible is ensured by the addition of lime, which forms a basic slag.

Many slag changes are carried out during the process, as in the silicothermic manufacture of low-carbon ferromanganese. The refined metal has the following typical percentage composition:

|            |        |
|------------|--------|
| Manganese  | 93–97  |
| Carbon     | < 0.10 |
| Silicon    | 1.5    |
| Phosphorus | < 0.06 |

The system is moderately efficient and the manganese yield is 63–64%, with slag losses accounting for the remainder.

#### 47.6.5 Distillation of Ferromanganese

Pechiney has filed patents dealing with the vacuum distillation of ferromanganese at 1200–1350 °C. The process has not been used on a large-scale since the manganese produced is inferior to electrolytic manganese and the production costs are prohibitive.

#### 47.6.6 Electrolysis of Fused Salts

Manganese has been produced on a laboratory scale by the electrolysis of fused salts. A system in which an untreated manganese ore is dissolved in a fused mixture of calcium and manganese fluorides and electrolyzed at

1150–1200 °C has been described [44]. The cell potential was 5.5–6.5 V and current density was 9–11 A/cm<sup>2</sup> at the anode, and 2–2.5 A/cm<sup>2</sup> at the cathode. Manganese purity in the range 80–99.3% was obtained at current efficiencies of 53–65%.

### 47.7 Manganese in the Iron and Steel Industry [45]

More than 90% of the manganese mined is used in the steel industry (Figure 7.8). In the production of normal mild steel, high-carbon ferromanganese and silicomanganese are used; however, in special low-carbon steels, medium-carbon ferromanganese, low-carbon ferromanganese or electrolytic manganese is used. A steel producer has to weigh up the additional costs of the refined manganese alloys against the extra time in the argon oxygen decarburization process that would be necessitated by the use of carbon-containing alloys [46]. Manganese occupies a special place among all alloying elements as it is present in almost all types of steel and cast iron.

The addition of manganese to iron-carbon systems has the following effects:

- It retards the rate of transformation (i.e., it increases the hardenability).
- It lowers the martensitic start temperature. This effect is 40 °C at 1% addition of manganese and increases linearly to 200 °C with 5% addition.

Manganese has extensive solid solubility in austenitic iron; therefore, it has no solution hardening effect in austenite. The solubility of manganese in ferritic iron is limited to 3%. Hence, manganese exhibits a solution hardening effect in ferrite (30–40 MPa per % Mn).

Hadfield's austenitic manganese steels (which were developed from 1882) contain 1–1.4% carbon and 10–14% manganese. When they are quenched from 1000 °C the normal hardening transformation temperature is suppressed by the manganese and the steel remains austenitic at room temperature. These steels are exceptionally tough, have high tensile strength, and are wear resistant due to

work hardening. As a consequence, they are used extensively in the mining and earth moving industries.

Manganese is a milder deoxidant than silicon and aluminum. Manganese enhances the effectiveness of aluminum and silicon as deoxidizers of steel due to the formation of stable manganese silicates and aluminates.

The solubility of nitrogen in ferrite is increased by the presence of manganese. The solution hardening effect of manganese is considerably enhanced by nitrogen, which is valuable in high-temperature creep-resistant alloys. Both the yield and ultimate stress at elevated temperatures are increased by the presence of nitrogen in steel, and this effect is enhanced by the presence of manganese.

Nitrogen is a powerful austenizing agent in steels and can be used as a partial substitute for nickel in austenitic stainless steels. The solubility of nitrogen in stainless steels is increased by the addition of manganese, and this is the basis of the series 200 stainless steels.

Manganese has had a long association with the efforts of steel makers to remove sulfur and to minimize the harmful effects of residual sulfur in steel. In the absence of sufficient manganese, sulfur can concentrate in the interstitial liquid in the form of ferrous sulfide. This compound has a low melting point and can persist as a liquid down to low working temperatures. This can cause cracking (hot shortness) during steel rolling. Steel requires a manganese to sulfur ratio of 4 for adequate ductility in the hot working range (950–1150 °C). In practice, ratios of up to 20 are used.

One of the most significant properties of steel is its ability to harden with heat treatment. A number of alloying elements can influence the hardenability of steels but manganese has become virtually synonymous with hardenability due to its effectiveness, availability, and relatively low cost. Increasing the manganese content permits the use of lower heat treating temperatures for steel parts

where the use of higher temperatures would result in deformation.

Shortages, notably during the Korean War, originally prompted the use of manganese as a replacement for some of nickel in austenitic stainless steels.

## 47.8 Processing of Manganese Nodules and Encrustations

The primary economic interest in manganese deposits on the ocean floor has never been for the manganese content, but rather for the associated valuable metals, including nickel, copper, and cobalt. There are, however, some indications that the manganese content is becoming more attractive in its own right.

The deep ocean resources of manganese nodules were first discovered during the British HMS Challenger expedition of 1872–1876. The commercial potential of these resources was recognized in 1958 as a result of work undertaken at the University of California.

### 47.8.1 Occurrence, Origin, and Composition [47–50]

**Occurrence.** Manganese nodules occur over most of the deep ocean floor, but are currently considered to have economic potential in one primary and three subsidiary areas (Figure 47.6). The primary area is located in the northwestern equatorial Pacific (the Clarion Clipperton zone), and the subsidiary areas are in the South Pacific, western equatorial Pacific, and the central Indian Ocean. All of the main areas of potentially economically viable manganese nodules occur on the abyssal seafloor.

Limited quantities of ore-grade nodules have been identified within the Exclusive Economic Zones (EEZ) of some of the western Pacific islands.

Manganese encrustations occur on oceanic seamounts, primarily in the Pacific ocean.

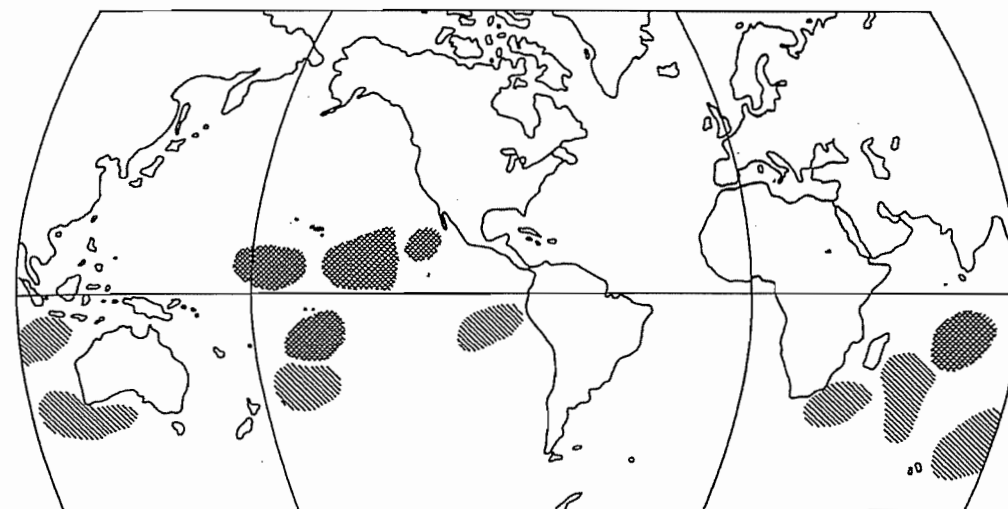

Figure 47.6: Manganese nodule occurrence. □ Areas of high nodule concentration; ▨ Areas of potential economic viability.

**Origin.** Manganese on the ocean floor originates from two primary sources: runoff from the continents and submarine volcanic activity. It is believed that plankton extract the manganese and associated metals from seawater and carry them to the ocean floor after death.

The metals are liberated by organic decay processes into the pore water of the deep-sea muds, where, by a series of diagenetic reactions, they migrate to centers of nucleation within the uppermost sediments and precipitate to form manganese nodules. Encrustations are formed on exposed rocks.

**Composition.** The chemical composition of manganese nodules varies widely. Some 74 elements have been found to occur in manganese nodules and encrustations. The average chemical composition varies from ocean to ocean and with latitude, water depth, and mineralogy.

World averages of nodule composition are influenced by the disproportionately high number of stations located in the Pacific Clarion Clipperton zone, in which the nodules average 25.4% Mn, 6.66% Fe, 1.27% Ni, 1.02% Co. Excluding these values from the world averages decreases the average nickel, copper,

and manganese contents, increases the iron content, and has no effect on the cobalt content.

Principle metal contents, together with nodule concentration and depth, are listed in Table 47.8.

Table 47.8: Chemical composition of manganese nodules.

| Element | Mean content, % | Range, %   |
|---------|-----------------|------------|
| Mn      | 18.60           | 0.04–50.3  |
| Fe      | 12.47           | 0.30–50.0  |
| Ni      | 0.66            | 0.01–1.95  |
| Cu      | 0.45            | 0.101–1.90 |
| Co      | 0.27            | 0.01–2.23  |

The top of a nodule is generally higher in Fe, Co, and Pb and lower in Cu, Ni, Mo, Zn, and Mn compared to the bottom. The nodule core is usually deficient in Fe, Co, and Pb.

**Physical Characteristics.** Manganese nodules generally exhibit five external shapes: spheroidal, ellipsoidal, discoidal, botryoidal, and flat faced. The surface textures, which may be smooth or granular, may vary on the opposite sides of the nodule. The size varies from 0.5–20 cm, with concretions larger than 20 cm generally assuming the form of slabs. The color is usually dark reddish brown to black. Some zonal pattern in nodule cross sec-



tion, produced by variation in mineral content of the growth layers, is generally present. The porosity is relatively high and relative density low (2.1–3.1).

Water comprises about 45–50% of nodules when removed from the ocean. Air drying removes about half of this water. Approximately 5–10% water is contained within the crystal structure.

**Mineralogy.** Nodules comprise a complex mixture of organic and colloidal matter, nucleus fragments, and crystallites of various minerals. The phases are fine grained, often metastable, poorly crystallized, and intimately intergrown.

Todorokite, birnessite, and vernadite are the predominant manganese oxide minerals, while various other  $MnO_2$  modifications in the form of  $\alpha$ - $MnO_2$ ,  $\beta$ - $MnO_2$ , and  $\gamma$ - $MnO_2$  have also been reported.

Iron is present as oxide, oxyhydroxide, and hydrated oxide phases, the most commonly observed being ferroxhyte, goethite, and lepidocrocite.

The accessory minerals can be divided into the following three categories: sheet silicates and zeolites, clastic silicates, volcanic minerals, and biogenic minerals.

Known minerals of nickel, copper, or cobalt have not been identified; Cu, Mo, Ni, and Zn are associated almost entirely with the manganese mineral phase. Ba, Cd, Ca, Mg, Sb, Sr, and V are usually associated with manganese but are also found in other phases. Pb and Ti are associated almost entirely with the Fe and Mn phases.

### 47.8.2 Legal Considerations and Nodule Recovery [47, 49, 51–54]

**Legal Considerations.** The Law of the Sea as pertaining to the exploitation of mineral resources is of major importance to the future viability and prospects of commercial venture.

During the early 1960s interest in deep-ocean mining increased and the Third UN Law of the Sea conference began in 1974. The

current Convention was eventually adopted by this conference in 1982.

The United States, Germany, and United Kingdom voted against the convention because of objections to certain provisions related to deep-sea mining.

The most important of the above regimes as pertaining to manganese nodule exploitation are the EEZ, extending to 200 nautical miles from the coastal state shoreline, and the so-called Area, extending beyond this limit. The coastal state has sovereignty over the EEZ, but the sea floor outside these zones falls under the jurisdiction of an International Seabed Authority which will be responsible for all mineral deposits and even mine these deposits through its own organization. The Authority would also license independent mining organizations to exploit these deposits, but in doing so would impose a number of conditions which some national governments and mining consortia find unacceptable.

The 200 mile EEZ would put under coastal state jurisdiction most of the minerals of the continental margins and, in some areas, those of the deep-ocean floor.

The convention also limits the amount of nickel that can be produced outside the EEZ over the first 20 years of commercial production in order to protect the markets of land-based producers.

The United States, Germany, France, the United Kingdom, the Soviet Union, and Italy have passed national deep-seabed mining legislation which, in many instances, is in contradiction of the UN Convention.

**Nodule Recovery.** Research into nodule recovery has been conducted since the 1960s and the technical feasibility, to a large extent, has been established.

Three main systems have been investigated: the continuous line bucket, the autonomous shuttle, and hydraulic pumping with a suspended conduit or dredge pipe.

Techniques based on continuous hydraulic pumping systems are the most technically and economically viable.

### 47.8.3 Processing

The following processes [48, 49, 55, 56] for recovering the metals of value (Mn, Co, Ni, Cu) from nodules have been identified as being potentially feasible:

- Gas reduction and ammoniacal leach
- Cuprion ammoniacal leach
- Elevated temperature and pressure  $H_2SO_4$  leach
- Reduction and HCl leach
- Smelting and  $H_2SO_4$  leach

The first three of the above options recover Co, Ni, and Cu, while Mn can be optionally recovered from the tailings. The last two are more suited to the recovery of all four metals.

Ammoniacal processes are similar to those used for the treatment of land-based nickeliferous laterites which, in some respects, are similar to manganese nodules. Cobalt, nickel, and copper are soluble in  $NH_3-NH_4CO_3$  (the Caron process) and  $NH_3-(NH_4)_2SO_4$  solutions.

These processes involve selective reduction of the metals and disruption of the nodule matrix to permit rapid, complete dissolution of the valuable metals. Acidic chloride solutions are also capable of dissolving the valuable metals including manganese. Acidic sulfate solutions can solubilize cobalt, nickel and copper. Nickel is recovered from laterites by sulfuric acid leaching at elevated temperature.

The diverse chemical, physical and mineralogical composition of the nodules exclude physical enrichment prior to the complex hydrometallurgical processing. Separation on the basis of density, magnetic properties, or flotation has not been successful.

The recovery of manganese from the tailings of the ammoniacal processes (routes 1 and 2 above) involves flotation of the  $MnCO_3$ , which could then be converted to a manganese oxide product for further processing or sale. Manganese dioxide could be recovered from the  $H_2SO_4$  process tailings (route 3 above) by dissolution and chemical treatment. Direct use of the tailings from all the processes above for ferromanganese production is probably pre-

cluded due to the unacceptably high levels of trace metals, sulfur, and phosphorus.

#### 47.8.3.1 Gaseous Reduction and Ammoniacal Leach Process

This process (Figure 47.7) is an adaptation of the Caron process for nickeliferous laterites (see Chapter 12).

The  $MnO_2$  is reduced to MnO at 625 °C by a producer gas rich in CO. The mineral structure is disrupted by this reduction and the contained metals can be dissolved by an aqueous solution of 10% ammonia and 5%  $CO_2$  at 40 °C and atmospheric pressure. The pregnant solution is separated from the solids, and copper and nickel are isolated by solvent extraction and aqueous stripping. The products are recovered as cathode copper and nickel by electrowinning.

The aqueous  $NH_3-CO_2$  solution is contacted with hydrogen sulfide, and insoluble cobalt sulfides and residual copper, nickel, zinc, and other metals are precipitated.

This precipitate is removed and contacted with air and  $H_2SO_4$  to selectively redissolve the cobalt and the small amount of nickel still present. The cobalt and nickel are recovered from the liquid in powder form by selective reduction with hydrogen at 3.4 MPa and 185 °C.

The residual ammonia and carbon dioxide are removed from the nodule residue by steam at 120 °C and 0.2 MPa. The resulting mixture is condensed and, together with the mixture of ammonia carbon dioxide and steam arising from the cobalt extraction step, is recycled.

#### 47.8.3.2 Cuprion Ammoniacal Leach Process

Manganese dioxide is reduced in an aqueous ammoniacal solution containing an excess of copper(I) ions at 50 °C. The cobalt, nickel, and copper are solubilized in an aqueous solution of ammonia and carbon dioxide at 50 °C and atmospheric pressure. The separation and purification of the metals is identical to the Caron gas reduction process (Figure 47.7).

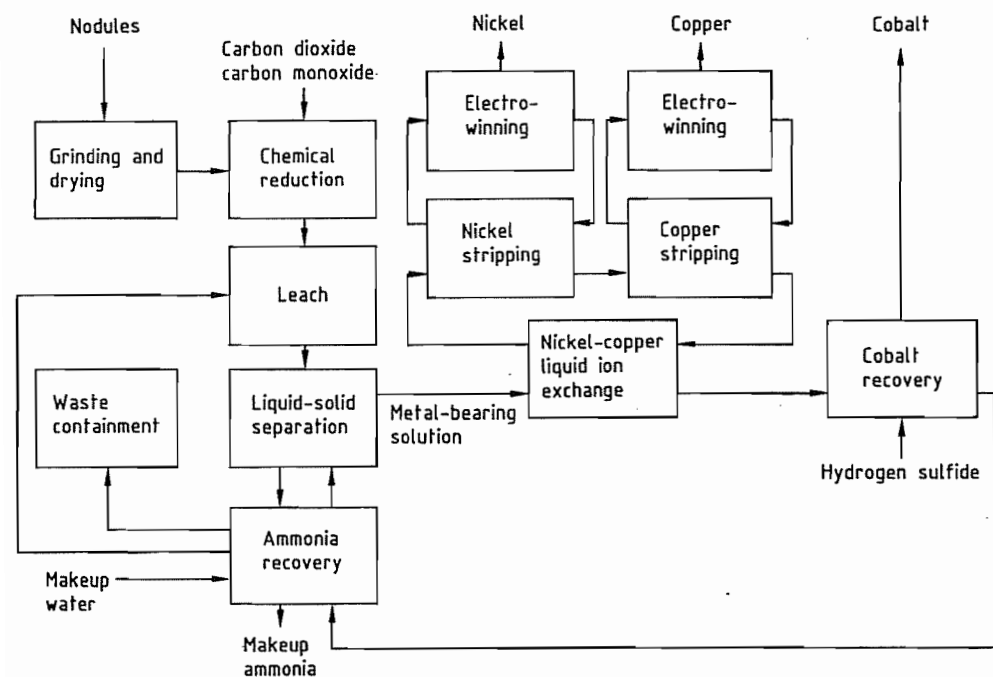

Figure 47.7: Gaseous reduction and ammoniacal leach process.

### 47.8.3.3 Elevated Temperature and Pressure $H_2SO_4$ Leach Process

In this process (Figure 47.8) the cobalt, nickel, and copper content of the milled nodules is dissolved in a 30% sulfuric acid solution at 245 °C and 3.54 MPa. Manganese and iron are not solubilized to any appreciable extent. The resultant slurry is cooled and the acid solution separated from the nodule residue. The pregnant solution is pH adjusted and the copper and nickel are selectively removed by extraction with an organic solvent. These metals are then stripped as copper and nickel sulfate in acidic aqueous solutions and subsequently recovered by electrowinning.

The cobalt is precipitated with hydrogen sulfide together with residual nickel, copper, and zinc. The precipitate is separated from the solution and contacted with air and  $H_2SO_4$  at 100 °C to selectively redissolve the cobalt and

residual nickel, which are recovered as powders from the solution by reduction with hydrogen gas at 3.4 MPa and 185 °C.

The ammonia is recovered from the barren solution and recycled. The barren, ammonia-free solution is recycled for washing of the leached nodule material.

### 47.8.3.4 Reduction and HCl Leach Process

In this process (Figure 47.9) the manganese dioxide is reduced to soluble manganese chloride with hydrogen chloride at 500 °C and 0.1 MPa. A portion of the hydrogen chloride is oxidized to chlorine. The excess hydrogen chloride is separated from this chlorine and water vapor and recycled. Dissolution of the iron in the nodules is minimized by injection of steam, which results in the hydrolysis of iron chloride to insoluble ferric hydroxide.

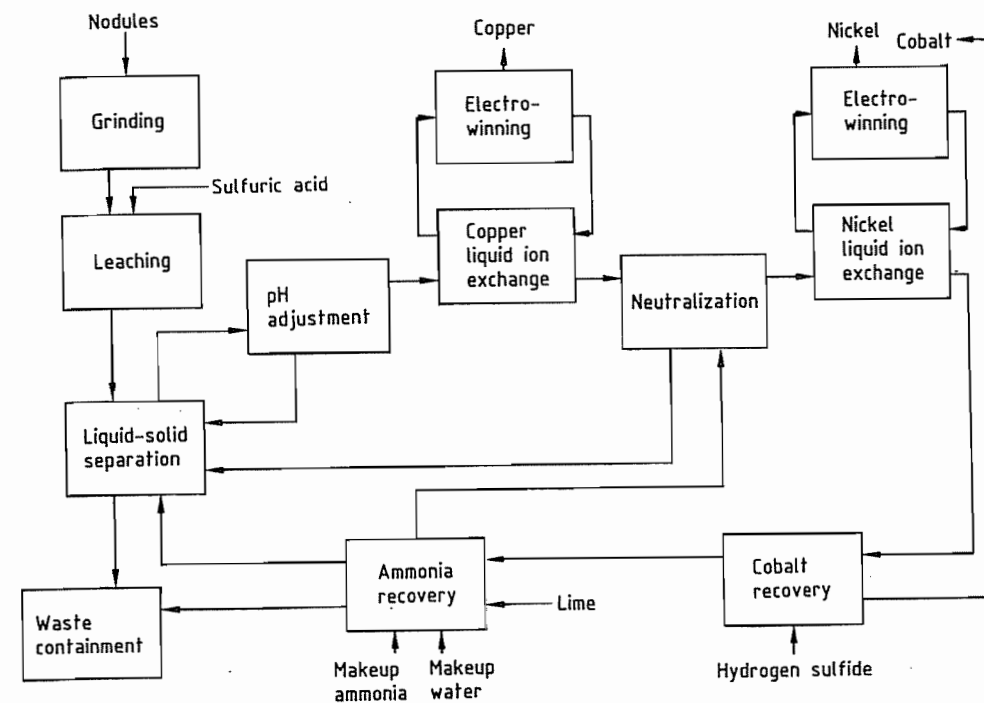

Figure 47.8: High-temperature, high-pressure sulfuric acid leach process.

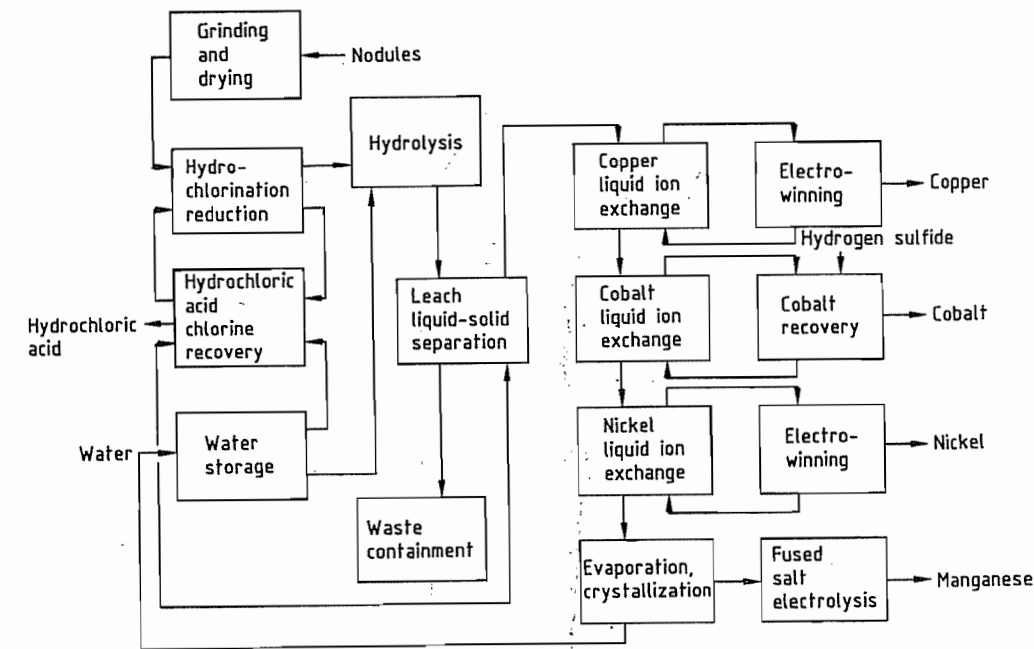

Figure 47.9: Reduction and hydrochloric acid leach process.

The soluble Co, Ni, Cu, and Mn chlorides are dissolved by leaching with HCl. Copper is selectively extracted by organic ion exchange and subsequently stripped into a strong  $H_2SO_4$  solution. The copper is recovered by electro-winning.

The copper-free chloride solution is neutralized and cobalt is removed by a second selective solvent extraction stage. The cobalt is recovered as a powder by a sequence of stripping, precipitation as cobalt sulfide by hydrogen sulfide, selective leaching, and hydrogen reduction.

The copper- and cobalt-free solution is subjected to a third solvent extraction stage to remove nickel. The nickel is stripped into an acidic sulfate solution for subsequent electro-winning.

The final aqueous chloride solution can be dried to produce impure manganese chloride,

which can be charged to an electrolysis furnace where it dissolves in a molten alkali chloride bath. Molten manganese is tapped from the furnace and cast. Chlorine gas is also produced from the electrolysis furnace and, together with the chlorine resulting from the initial hydrochlorination stage, can be converted to hydrogen chloride for recycling.

#### 47.8.3.5 Smelting and $H_2SO_4$ Leach Process

In the sulfuric acid leach process (Figure 47.10), the nodules are dried and the manganese dioxide and ferric oxide reduced to manganous and ferrous oxides at 625–1000 °C with coal and carbon-monoxide-rich producer gas. The reduced nodules, together with coke and silica, are hot-charged to an electric furnace.

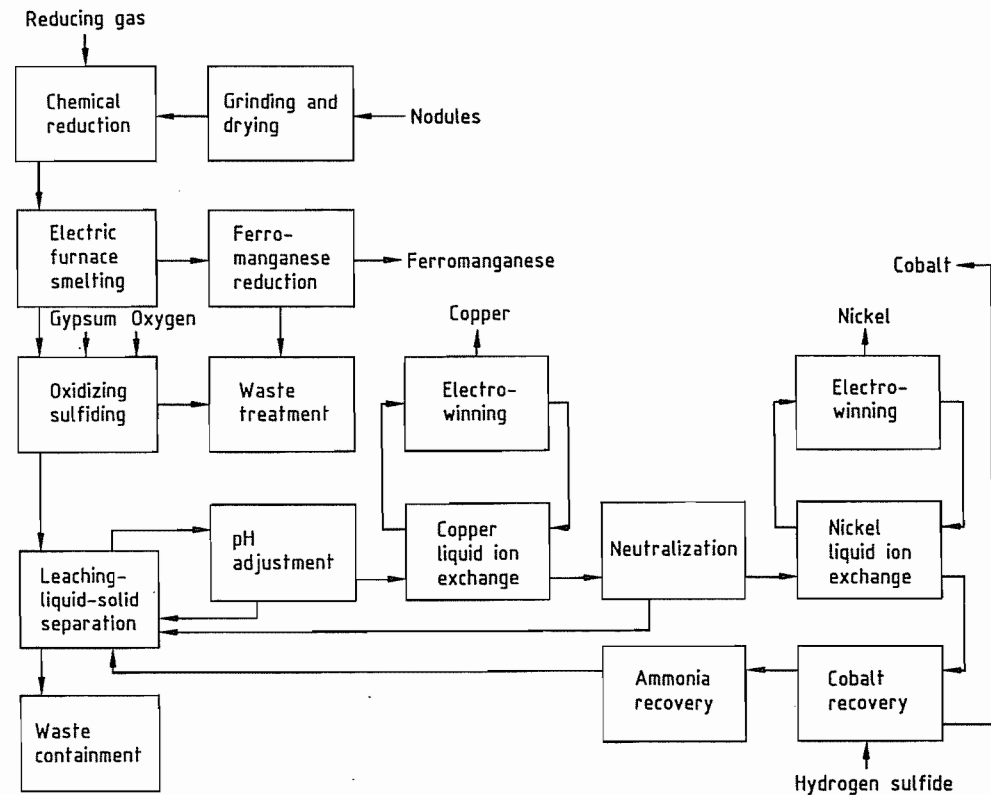

Figure 47.10: Smelting and sulfuric acid leach process.

In this step most of the Cu, Ni, Co, and Fe, and some of the Mn is reduced at 1425 °C to form a molten alloy phase, which separates by gravity from the unreduced management slag. The alloy is transferred to converters where, after the addition of further silica, the Mn and most of the Fe is reoxidized with air, separated as a slag, and recycled to the furnace. Gypsum, coke, and possibly sulfur are added to the alloy, producing a metal sulfide matte phase containing the Cu, Ni, and Co. These are separated in the converter and the slag is recycled to the electric furnace, while the matte is water quenched and granulated.

A ferromanganese alloy can be produced from the furnace slag by smelting, together with iron-rich slags and coke, in an electric furnace.

The metals are leached from the granulated matte with a 5%  $H_2SO_4$  solution in the presence of oxygen at 1 MPa and 110 °C. Copper and nickel are recovered separately from this solution by selective solvent extraction. The pH of the solution is controlled by addition of ammonia. The metals are stripped into acidic aqueous solutions and the products recovered by electro-winning.

Cobalt and the residual other metals are recovered from the aqueous ammonium sulfate solution by precipitation with hydrogen sulfide. The separated precipitate is contacted with air and  $H_2SO_4$  at 100 °C to selectively redissolve the cobalt and residual nickel, which are recovered in powder form by selective reduction with hydrogen at 3.4 MPa and 185 °C.

#### 47.8.4 Economic Viability and Future Prospects [47, 49–51, 57, 58]

The constraints inhibiting the exploitation of the nodule reserves are complex a combination of economic, technological, sociological, and political. Any operation would have to satisfy several prerequisites: technical feasibility of mining and processing; economic or strategic viability; legal authorization and security of tenure; and environmental acceptability.

Although most of the results of the extensive research and development work undertaken by several nodule recovery consortia has not been published, sufficient successful announcements have been made to indicate that the recovery and processing of nodules is technically feasible.

Numerous environmental impact assessments indicate that nodule dredging totally destroys the area of operation. Adjacent undredged areas, however, appear to be unharmed and provide the basis for rehabilitation. Adverse environmental effects are therefore short-lived.

The estimated economic viability of mining and processing nodules has been well reported, covering a wide range of scenarios. Estimates of the internal rate of return range from 3 to 18%, with the more recent studies showing lower rates. The high degree of risk associated with nodule exploitation probably necessitates a rate of return of ca. 30% to warrant investment. The studies also exhibit very high sensitivity to variations in commodity prices, metal recoveries, and deposit grades. From an economic viewpoint only, it is most likely that nodules will not be mined and processed in the foreseeable future without significant financial incentives in the form of price supports, market protection, and tax breaks.

The considerable uncertainty currently existing as to the legal authorization for mining beyond the limits of national jurisdiction (that is, outside the EEZ) casts more doubt on the feasibility of commercial nodule mining for some years to come. The prospects of commercial exploitation of the extensive deposits of cobalt-rich manganese oxide crusts lying within the EEZ are better than those for the nodules. The technical feasibility of recovering these crusts has not yet, however, been developed and tested.

The supply and demand situation, coupled to strategic considerations, for the four metals of interest will probably be the ultimate determining factor for future exploitation. Most mining consortia have only considered the recovery of cobalt, nickel, and copper. Recent reappraisals of manganese and its perceived

value as a strategic metal (particularly in the United States) has led to an increasing interest in four-metal extraction. A modest increase in manganese usage is predicted in future, directly coupled to steel production. The perceptions of the instability of cobalt supply from African sources increase the strategic sensitivity of this metal.

Another important use for nodules is as a stack gas absorption mechanism. Elimination or reduction of sulfur and nitrogen oxides is possible by catalytic oxidation by compositions involving transition metals. Nodules possess the high specific surface area and transition metal oxide content required for an oxidation catalyst. This use of nodules also provides a primary stage for the recovery of the metals of value. The complex metal oxides in the nodules are readily reduced to sulfides as a contaminated gas stream is passed through the filter pack of ground nodules. Well defined processing techniques, as described before, can then be applied to recover the four metals of interest.

## 47.9 Economic Aspects [59]

Ninety percent of manganese produced is consumed in the steel industry, and the growth of the manganese industry is therefore directly related to that of the steel industry. Steel production in the Western world dropped sharply in the early 1980s and bottomed out in 1982–1983. Economic recovery in the Western industrialized countries in the late 1980s resulted in strong growth in the steel sector. Between 1986 and 1988 the world production of crude steel increased by 9% to  $780 \times 10^6$  t and is likely to continue at this level into 1990, when a drop off is expected. Hereafter steel is expected to grow at ratio between 1% and 1.5% per annum however a migration of production capacity from developed to undeveloped countries will occur, China will become the world's largest producer of steel in the late nineties. As a consequence the demand for ferromanganese alloys has increased considerably. The increase in demand placed upward pressure on the price of ferromanganese and

silicomanganese in 1988 and 1989 and in terms of constant 1980 US\$ similar price levels are being achieved to those in the early 1980s (Figure 47.11). A sharp drop in the price of silicomanganese was experienced at the end of 1989 due to an excess of Chinese material in the market and the low ferrosilicon prices (Figure 47.12).

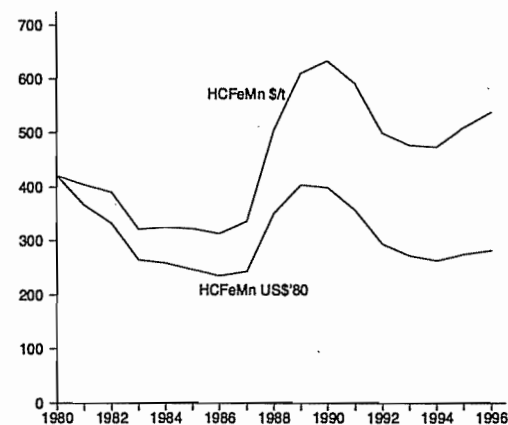

Figure 47.11: Price of ferromanganese.

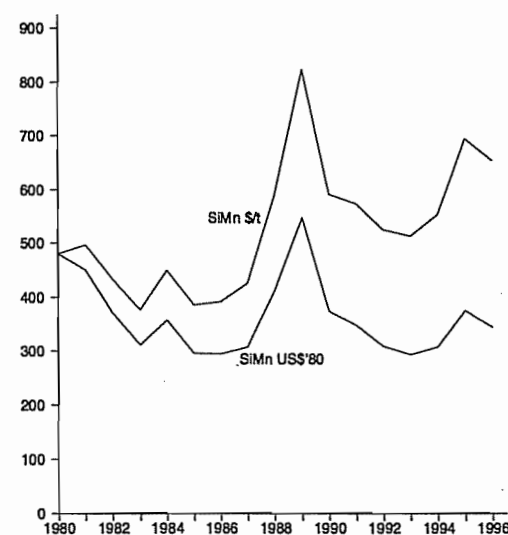

Figure 47.12: Price of silicomanganese.

Alloy prices remained low through the early nineties due to a stagnant world economy and a reorganization in the European steel industry. Recovery of prices began again in 1994 due to the rebuilding of the American

infrastructure and the collapse of the ex-Soviet steel industry.

In the future demand for alloys will shift to high- and medium-carbon ferromanganese from silicomanganese as mini mill steel producers increasingly introduce thin slab casting processes in their factories.

Prices of high and medium carbon ferromanganese should therefore remain reasonably firm, showing slight fluctuations as the steel goes through stocking and destocking cycles.

The increasing demand for high grade alloys has once again highlighted the shortage in the production capacity of high grade ores (as was the case in 1988–1989) (Figure 47.13). Traditional low grade ore producers, namely, the CIS, China and India are now becoming significant importers of high grade ore. China for instance imported 1.2 million tons in 1995. Ore prices are expected to flatten out at current levels and fluctuate in accordance with world electricity and coke prices.

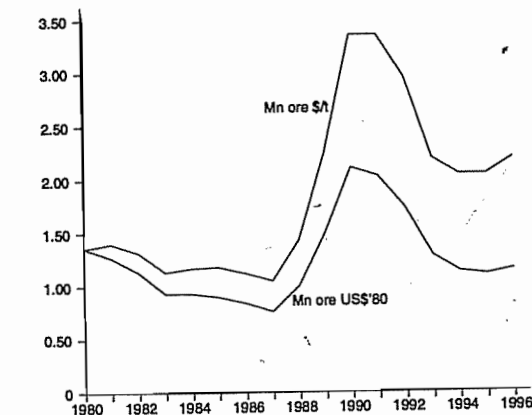

Figure 47.13: Manganese ore prices.

## 47.10 Compounds

### 47.10.1 Introduction [60]

Manganese compounds occur in all oxidation states from 3– to 7+, with 2+, 4+, and 7+ being the most important. Most of the species in which Mn displays a negative valence state are anionic; for example, the ion  $\text{Mn}(\text{CO})_5^{3-}$

[obtained by vigorous reduction of  $\text{Mn}_2(\text{CO})_{10}$ ] contains Mn in the 3– state. The 2– oxidation state can be found in a complex of manganese with phthalocyanine, whereas manganese in the 1– state is represented by the manganese pentacarbonyl ion  $\text{Mn}(\text{CO})_5^-$ . Ions representing the various positive valences display characteristic colors, as indicated in Table 47.9. The color of a particular ion in solution is not always the same as that of the corresponding solid compound. Thus, solid  $\text{MnO}$  is light green,  $\text{Mn}(\text{OH})_2$  is white, and  $\text{Mn}_3\text{O}_4$ ,  $\text{Mn}_2\text{O}_3$ , and  $\text{MnO}_2$  are black. Liquid  $\text{Mn}_2\text{O}_7$  is green under reflected light but deep red under transmitted light.

Table 47.9: Ionic species of manganese.

| Ion                 | Valence | Color          |
|---------------------|---------|----------------|
| $\text{Mn}^{2+}$    | 2+      | pink           |
| $\text{Mn}^{3+}$    | 3+      | red            |
| $\text{Mn}^{4+}$    | 4+      | brownish black |
| $\text{MnO}_3^{3-}$ | 5+      | blue           |
| $\text{MnO}_4^{2-}$ | 6+      | green          |
| $\text{MnO}_4^-$    | 7+      | purple         |

Given the multitude of valence states for manganese compounds, redox reactions are of great importance. Under suitable pH conditions, compounds containing manganese with a valence of 3+ or more are effective oxidants. Furthermore, tri-, penta-, and hexavalent manganese compounds tend to undergo disproportionation reactions under the influence of  $\text{H}^+$  and  $\text{OH}^-$ :

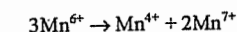
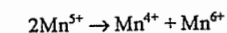
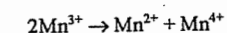

The divalent state is generally regarded as the most stable, at least in acid to neutral media. Tetravalent manganese is also quite stable as  $\text{MnO}_2$  under moderately acid and moderately alkaline conditions, while the heptavalent state displays maximum stability around pH 7. Precipitated manganese(II) hydroxide is oxidized at room temperature by oxygen to tri- and tetravalent manganese oxides in the presence of traces of alkali, while conversion to manganates (i.e., the penta- and hexavalent states) requires much higher temperatures and high alkali concentrations ( $\geq 180^\circ\text{C}$  for 60–

70% KOH). The basicity of the manganese oxides decreases (and the acidity increases) with increasing valency. Thus, MnO behaves as a basic anhydride, MnO<sub>2</sub> is amphoteric, and Mn<sub>2</sub>O<sub>7</sub> is an acidic anhydride. Even though manganese in its highest valence state (7+) resembles chlorine (i.e., perchlorate), its general reactivity corresponds more closely to that of iron.

## 47.10.2 Oxides

### 47.10.2.1 Manganese(IV) Oxide

#### Properties

Manganese(IV) oxide, MnO<sub>2</sub>, is deep black to dark brown and practically insoluble in water. It is more commonly referred to as manganese dioxide, occasionally as pyrolusite. Pyrolusite (German: Braunstein) is also the name of a specific MnO<sub>2</sub>-containing mineral. The purest manganese dioxide—corresponding rather closely to the formula MnO<sub>2</sub>—occurs in the form known as the β-modification. The compositions of other natural or synthetic manganese dioxides range from MnO<sub>1.7</sub> to MnO<sub>2.0</sub> with varying contents of lower-valent manganese, foreign cations (e.g., K<sup>+</sup>, Na<sup>+</sup>, Ba<sup>2+</sup>), hydroxyl ions, and water molecules. At least six distinct modifications of manganese dioxide have been characterized (α, β, γ, δ, ε, and ramsdellite) [61, 62], which differ according to their degree of crystallization and their content of foreign ions. The β-modification (as in the mineral pyrolusite) is not only the least reactive form of MnO<sub>2</sub> but also the most highly crystalline, and it comes the closest to having a stoichiometric composition. By contrast, γ-MnO<sub>2</sub> is nearly amorphous and much more reactive both chemically and electrochemically. When heated up to 500 °C, manganese dioxides frequently release water and/or undergo phase transitions; above 500 °C they liberate oxygen. Between 500 and 600 °C MnO<sub>2</sub> is converted into Mn<sub>2</sub>O<sub>3</sub>, and above 890 °C into Mn<sub>3</sub>O<sub>4</sub>. Manganese dioxide acts as an oxidant toward readily oxidizable

materials, its own valency changing from 4+ to 3+ or 2+. For example, under acidic conditions manganese dioxide oxidizes chloride ions to chlorine; hydrazine and hydroxylamine to nitrogen; iron(II) to iron(III); carbon monoxide to carbon dioxide; alkylbenzenes to aromatic carboxylic acids, ketones, and, in some cases, aldehydes; and oxalic acid to carbon dioxide.

In the presence of strong alkalis and at elevated temperature, however, manganese dioxide is itself readily oxidized by oxygen to manganese(V) and (VI) compounds. Other noteworthy properties of the various MnO<sub>2</sub> modifications include their sorptive and ion-exchange capabilities and their catalytic and electrochemical activities. The latter is of great importance to the dry-cell battery industry, which consumes large amounts of “battery-active” MnO<sub>2</sub> (especially the γ- and ε-modifications) for use as a depolarizer.

#### Natural Manganese Dioxide

Only about 5% of the world production of manganese ore (presently totalling about 27 × 10<sup>6</sup> t/a) is consumed in nonmetallurgical applications. In 1976 (the latest year for which data have been published), the following approximate tonnages of manganese ore were associated with applications other than steel making [63, p. 331]:

|  |               |
|--|---------------|
| For dry cell batteries (battery-active ore plus ore consumed in the production of battery-grade electrolytic manganese dioxide and chemical manganese dioxide) | 500 000 t/a   |
| In brick and ceramic coloring, including in glass manufacture  | 200 000 t/a   |
| In welding rod manufacture   | 200 000 t/a   |
| For the production of Mn chemicals and diverse chemical and metallurgical products   | 450 000 t/a   |
| Total  | 1 350 000 t/a |

Within limits, these consumption figures are probably still applicable, because world ore consumption in 1976 (24 × 10<sup>6</sup> t/a) was only slightly less than that in 1986 (25 × 10<sup>6</sup> t/a), and about 5% is still consigned to metallurgical uses. Organic MnO<sub>2</sub> oxidations are generally carried out in the presence of sulfuric acid, and they lead to manganese sulfate as a by-product. Oxidation of aniline by MnO<sub>2</sub> in

the presence of sulfuric acid was once the main industrial route to hydroquinone, but since the late 1960s this technique has been largely replaced by other methods, at least in the Western world. For more information on the synthetic applications of native manganese dioxide [64, pp. 36–37].

Several processes are known for the recovery of manganese from low-grade MnO<sub>2</sub>-containing ores (Mn content < 20%) [65, pp. 727–731; 66], but they are currently of little practical significance since high-grade manganese ores (Mn > 40%) are widely available at moderate prices.

#### Synthetic Manganese Dioxides

##### Commercial Forms

Several types of synthetic manganese dioxide are produced commercially for specific end uses. In principle, synthetic manganese dioxide can be prepared either by a strictly chemical route (*chemical manganese dioxide*, CMD) or by electrochemical methods (*electrolytic manganese dioxide*, EMD).

Procedures leading to CMD include the oxidation of Mn(II) salts or lower manganese oxides, reduction of permanganates, thermal decomposition of manganese(II) nitrates, thermal decomposition/oxidation of manganese carbonate, and disproportionation of Mn(III) compounds.

Manganese dioxides obtained by reduction of permanganate are commonly known as *manganites*. They correspond to the δ-modification of MnO<sub>2</sub> and should actually be regarded as salt-like combinations of hydrous manganese dioxide and cations of base-forming metals (e.g., K<sub>2</sub>O·4MnO<sub>2</sub>). The metal portion is exchangeable against other cations. Such manganites [which are actually alkali manganates(IV)] are often obtained as by-products from technical permanganate oxidations, but they may also be synthesized intentionally by direct reduction of permanganate (e.g., with manganese(II) salts). Until the late 1960s, the manganites were important in the manufacture of dry cells because they are

highly active depolarizers. Manganites for this purpose were produced and sold in Europe under such trade names as Manganit and PermanoX. However, in recent years they have been largely displaced by electrolytic manganese dioxide (EMD) and the other types of chemically prepared manganese dioxide (CMD) described later.

Also of interest is the *hydrated manganite*, better known as *active manganese dioxide*, used in organic syntheses under nonaqueous, neutral conditions. Manganese dioxide of this type is generally prepared from MnSO<sub>4</sub> and KMnO<sub>4</sub> under strictly controlled conditions. Numerous methods are available for the preparation of “active” manganese dioxide. Many involve oxidation of a Mn<sup>2+</sup> salt with KMnO<sub>4</sub>, but NaClO<sub>3</sub> or O<sub>3</sub> are also used as oxidants. In a typical procedure, a solution of manganese sulfate (151 g/2.87 L) is added with stirring to a solution of potassium permanganate (105 g/2 L), and the resulting suspension of hydrous MnO<sub>2</sub> is stirred at 60 °C for 1 h. After filtration and washing, the precipitate is dried to a constant weight at 60 °C [67, p. 122]. These conditions lead to precipitated MnO<sub>2</sub> in the poorly crystallized but very reactive γ-form. It is a specific oxidant whose uses include dehydrogenation (e.g., the preparation of unsaturated aldehydes and ketones from unsaturated alcohols) and coupling reactions.

Mention should also be made of the increasing use of manganese-dioxide-based *oxidation catalysts*, particularly for air pollution abatement (removal of volatile organics, destruction of Ozone) [68, 69].

Another commercial CMD is a *high-purity manganese dioxide* used in the manufacture of high-purity lower manganese oxides as well as ferrites (ceramic magnets) and thermistors for the electronics industry. This product (99.5% MnO<sub>2</sub>) is obtained by thermal decomposition of manganese nitrate:

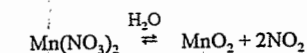

For a description of the original manganese nitrate process developed by IG Farbenindustrie (Bitterfeld) in the 1920s, see [70]. A later

modification of this process by Chemetals has been utilized at a plant in Baltimore since the early 1970s [71, 72] (Figure 47.14).

A concentrated solution of manganese nitrate (made from  $MnO_2$  ore by reaction with  $NO_2$ ) is first purified and then thermally decomposed at about  $140^\circ C$  in a well-agitated, externally heated reactor. The resulting  $\beta$ -manganese dioxide precipitates as a fine, free-flowing powder; the nitrogen dioxide coproduct is recycled to generate new manganese nitrate. Chemetals' production capacity for high-purity manganese dioxide is about 6000 t/a.

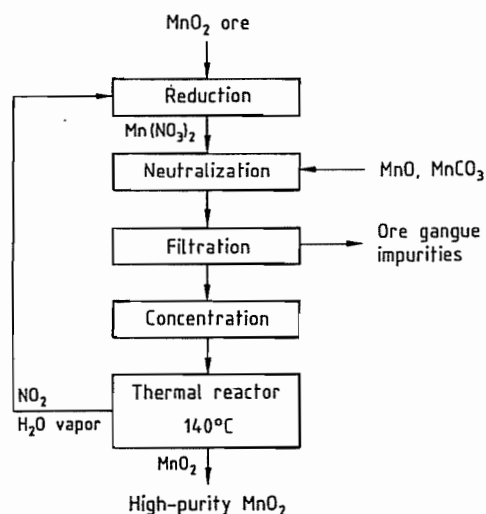

Figure 47.14: Manufacture of high-purity manganese dioxide  $MnO_2$  (Chemetals process).

### Synthetic Manganese Dioxides for Dry Cells

From a commercial standpoint the most important synthetic manganese dioxides are those that are electrochemically active and are therefore useful as depolarizers in dry-cell batteries. Electrochemical or battery activity of  $MnO_2$  results from a favorable combination of such factors as crystal structure, surface area, porosity, and chemical purity. Battery activity is not readily predictable; the only reliable

way of establishing this property is by an actual performance test in a battery.

One important type is the so-called *activated manganese ore*, actually a semisynthetic product. It is made by roasting a high-grade oxidic manganese ore containing at least 80%  $MnO_2$  but with low or no battery activity at  $600^\circ C$ . The product is then treated with hot sulfuric acid.

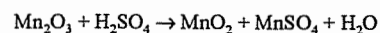
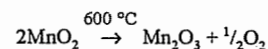

The second reaction is a disproportionation of trivalent manganese leading directly to battery-active  $\gamma$ - $MnO_2$ . The coproduct  $MnSO_4$  must be separated by leaching with water. Activated manganese ore is somewhat less effective as a depolarizer than EMD or fully synthetic CMD (see below), but it is still produced in France at a rate of several thousand tonnes per year under the names Ergogene and Philodyne.

**Chemical Manganese Dioxide (CMD).** Much more important than activated ores are the CMD products manufactured by the Sedema Division of Sadacem S.A. in Belgium under the trade names Faradiser M (for Leclanché and magnesium cells) and Faradiser WSZ (for zinc chloride batteries). The chemical compositions of the two products are practically identical: ca. 90%  $MnO_2$  (primarily the  $\gamma$ -modification), 2% water, plus minor amounts of lower manganese oxides. Critical trace impurities (Co, Ni, Cu, Mo) are kept below 0.001%. Types M and WSZ differ in such physical properties as surface area and density. Typical particle sizes are  $80\% < 44 \mu m$  for type M and  $85\% < 44 \mu m$  for type WSZ.

The first step in the production process [72, 73] (Figure 47.15) is the reduction of  $MnO_2$  ore to  $MnO$  using heavy fuel oil and a temperature of ca.  $900^\circ C$ . The  $MnO$  is then treated with sulfuric acid to form manganese(II) sulfate. After careful neutralization with  $MnO$  to precipitate heavy metal impurities, solids are removed by thickening.

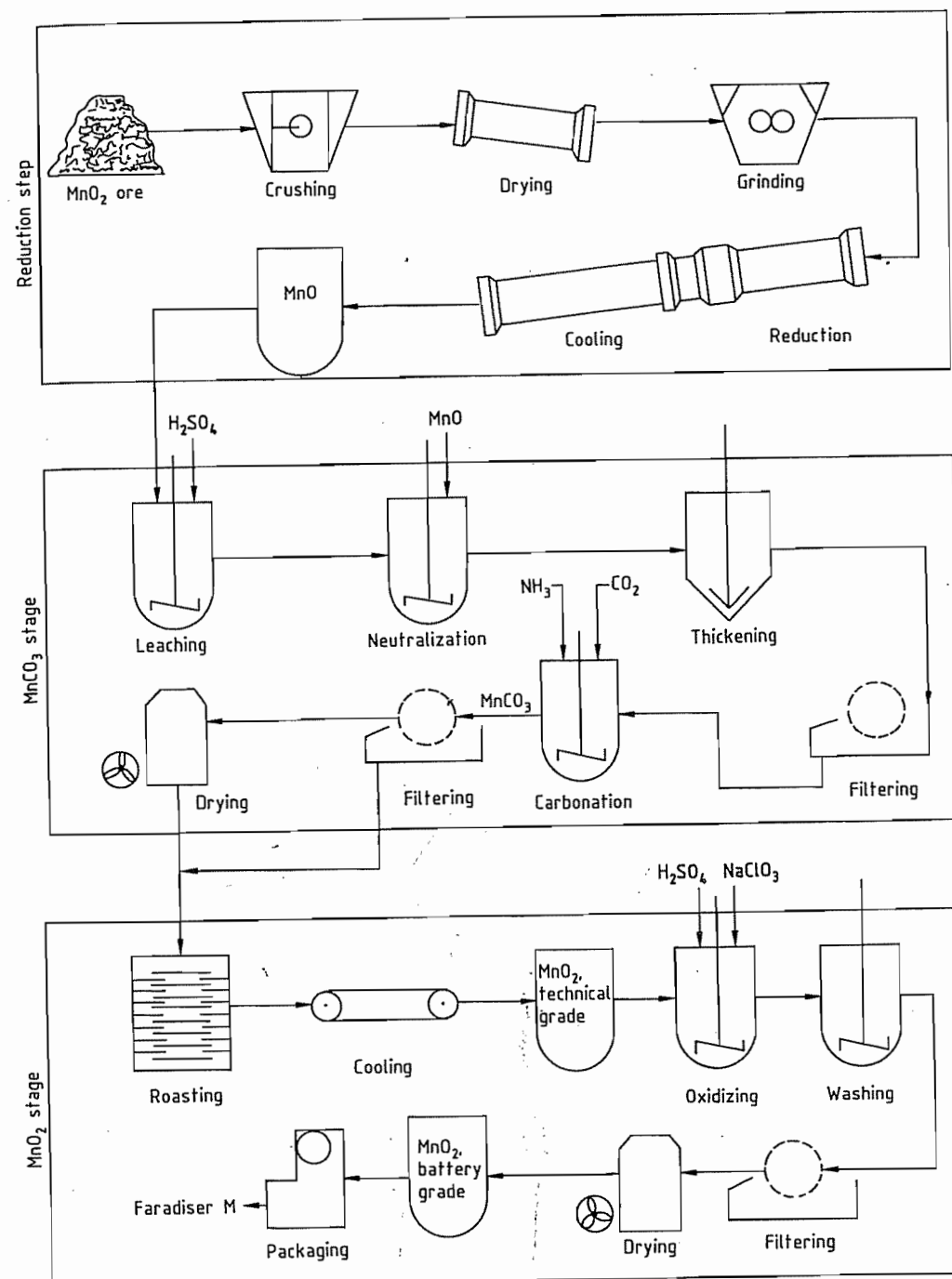

Figure 47.15: Production of chemical manganese dioxide (CMD) according to the Sedema process [72].

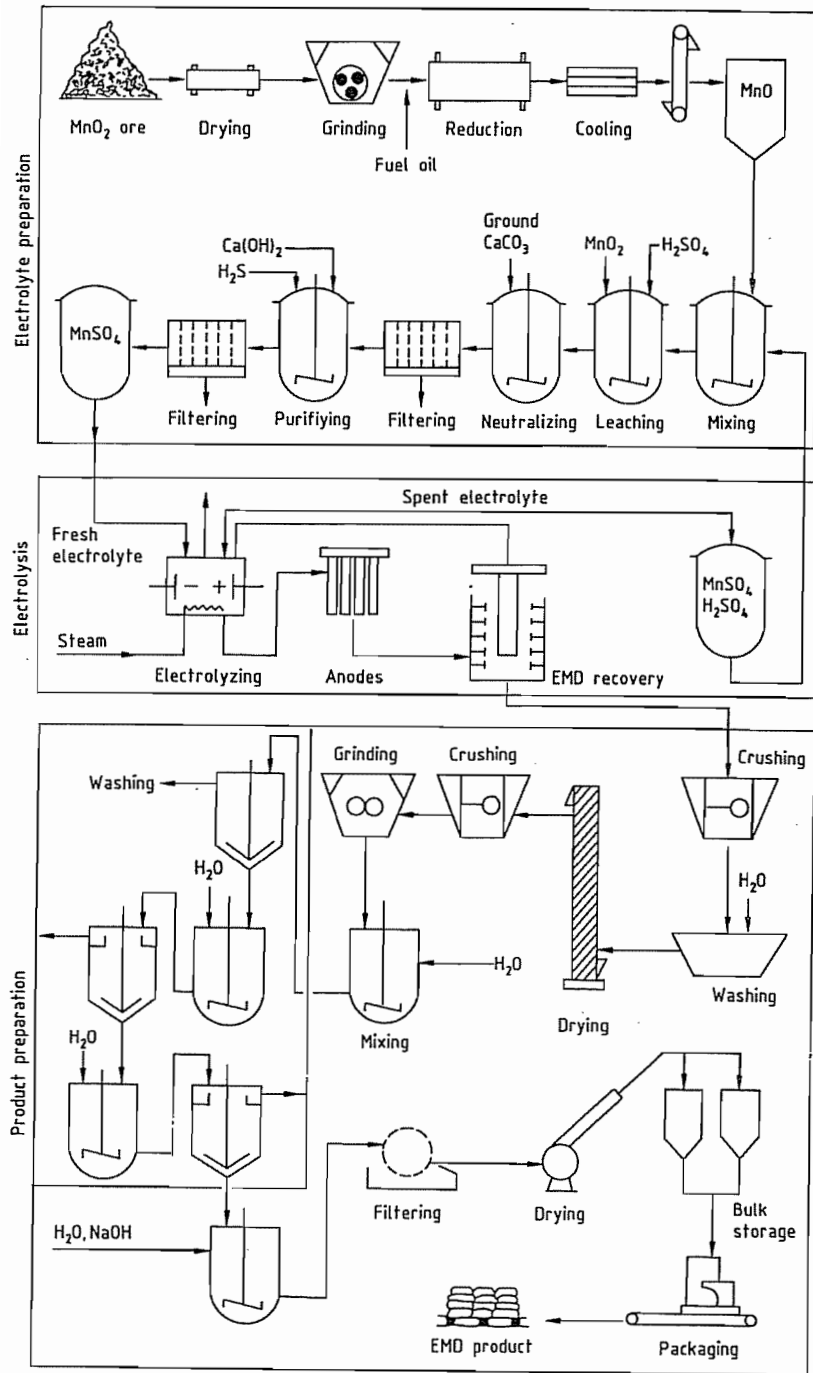
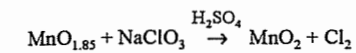
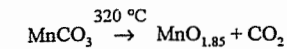

Figure 47.16: Production of electrolytic manganese dioxide (EMD) according to the process used by Tekkosha, Greece [72].

The solution of  $\text{MnSO}_4$  is then treated with ammonium carbonate (by simultaneous addition of  $\text{NH}_3$  and  $\text{CO}_2$ ) to precipitate manganese(II) carbonate, ammonium sulfate being generated as a by-product. The  $\text{MnCO}_3$  is separated and dry-roasted in the presence of air at about  $320^\circ\text{C}$  to form a higher manganese oxide with the approximate composition  $\text{MnO}_{1.80-1.85}$ . Complete oxidation to  $\text{MnO}_2$  is achieved by treatment with  $\text{NaClO}_3$  in the presence of sulfuric acid.

The key oxidation reactions may be represented as



Sedema has recently introduced a process improvement in the course of expanding their production in which the  $\text{MnO}_2$  is transformed directly to  $\text{Mn}(\text{NO}_3)_2$  by reaction with nitric oxides. The procedure is similar to the first step in the Chemetals synthesis of high-purity manganese dioxide. The  $\text{Mn}(\text{NO}_3)_2$  solution thus obtained is treated with ammonium carbonate to give manganese carbonate (processed as before) and ammonium nitrate. The latter by-product is more readily marketed as a fertilizer than the previously obtained manganese sulfate [74].

**Electrolytic manganese dioxide (EMD)** is the most important of the synthetic manganese dioxides even though it is a relatively new commodity. Practically all the EMD produced is used in the manufacture of dry cells and electronic materials such as ferrites.

The electrolytic preparation of  $\text{MnO}_2$  was discovered during the first half of the 19th century, but the outstanding suitability of the product as a depolarizer for dry cell batteries was not recognized until 1918 [75]. Commercial production started in Japan and the United States during the 1930s. By about 1952 the Japanese industry had perfected their technology to such an extent that the performance of dry cells made with EMD was about two to three times that of cells made with native bat-

tery ore [76]. Ever since, the Japanese EMD industry has maintained its world leadership in this field.

Electrolytic manganese dioxide is a black powder and typically contains 91%  $\text{MnO}_2$  (mostly the hexagonal  $\epsilon$ -modification [77]), 3–5% moisture, up to 1.3% sulfate, < 0.02% Fe, and very low residual concentrations (< 0.001%) of such metals as Pb, Cu, and Co. The balance consists largely of lower manganese oxides. The true density of EMD ranges from 4.0 to 4.3  $\text{g}/\text{cm}^3$ , and its tap density from 2.2 to 2.3  $\text{g}/\text{cm}^3$ . The BET surface area is 40–50  $\text{m}^2/\text{g}$  [76] with a particle size of < 74  $\mu\text{m}$  (< 200 mesh).

The outstanding performance of EMD as a battery depolarizer (especially in high-performance alkaline cells) is a result of its unique solid state properties (which permit free transport of protons through the lattice) and the virtual absence of elements that promote the corrosion of zinc metal [78].

Production of EMD usually starts from manganese dioxide ore [72; 79, p. 385; 80, p. 637; 81] (Figure 47.16), which is first reduced to  $\text{MnO}$  with either coal, heavy fuel oil, hydrogen, or natural gas. The  $\text{MnO}$  is then leached with sulfuric acid to form a manganese sulfate solution. Alternatively, if the rhodochrosite (manganese carbonate) is the starting material (as in Japan), only a leaching step with sulfuric acid is required. The acidic manganese sulfate solution is then purified by oxidation with  $\text{MnO}_2$  and neutralized with lime to a pH of 4–6. This treatment precipitates any heavy-metal ions present (Fe, Pb, Ni, Co). Hydrogen sulfide may be added for even more complete purification. After filtration and adjustment of concentrations to 75–160  $\text{g}/\text{L}$   $\text{MnSO}_4$  and 50–100  $\text{g}/\text{L}$   $\text{H}_2\text{SO}_4$ , the manganese sulfate solution is subjected to electrolysis, which can be represented in simplified form by the following reactions:

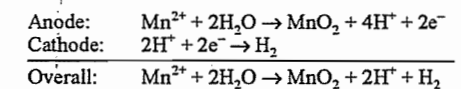

The electrolytic cells generally consist of open steel troughs equipped with an acid-re-

sistant, electrically nonconductive lining (e.g., Hypalon, rubber, or ceramic). The anode is made from graphite, hard lead, or titanium. Anode current density is 70–120 A/m<sup>2</sup> at a cell voltage of 2.2–3.0 V. During the electrolysis, which is carried out at 90–98 °C (a paraffin layer is used to minimize evaporation), the concentration of MnSO<sub>4</sub> decreases and that of H<sub>2</sub>SO<sub>4</sub> increases. Current yields range from 70% in older installations to > 90% in modern plants. In practically all commercial processes the EMD is deposited as a solid coating on the anode.

Electrolysis is terminated when the EMD deposit is 20–30-mm thick (requiring 14–20 d). The product is then mechanically removed from the anode, crushed, repeatedly washed with hot water, dried, and ground to the desired particle size (which depends upon the grade). The ground product is resuspended in water, adjusted to pH 6.5–7.0 with alkali, dried at 85 °C to a defined residual water content, and packaged.

Much of the recent progress toward economical production of high-quality EMD is related to technical advances in electrolytic cell (especially electrode) technology. Nevertheless, many EMD producers still use graphite and lead anodes (Table 47.10). The main disadvantage of graphite anodes lies in their relatively short life; lead anodes lead to undesirable product contamination. The modern trend is toward titanium anodes, which are mechanically and chemically stable and do not cause product contamination. One of the apparent limitations of titanium anodes is the formation of a passivated layer on the electrode surface at current densities > 80–90 A/m<sup>2</sup>, but this problem has been overcome by the addition of a mixture of finely ground manganese oxides (MnO<sub>2</sub>, Mn<sub>2</sub>O<sub>3</sub>, Mn<sub>3</sub>O<sub>4</sub>) to the electrolyte [83]. Cells are now operated at current densities ≥ 150 A/m<sup>2</sup>, resulting in a substantial increase in productivity.

**Economic Aspects.** World capacity for CMD is estimated to be ca. 40 000 t/a. This includes the Sedema Division of Sadacem in Belgium, Chemetals Corporation in the United States,

and several plants in the former Soviet Union. Actual consumption is about 25 000 t/a [84]. Even though CMD has its own established niches in the battery industry, it also competes increasingly with EMD as a depolarizer in high-performance cells.

Electrochemical manganese dioxide is now the most important fastest growing synthetic manganese product due to the high growth rate of the dry-cell battery and electronic component markets. World production capacity for EMD is approximately 183 000 t/a (Table 47.10) and growing. The EMD capacities in Japan and the United States are 73 000 and 32 000 t/a, respectively. Additionally, two Japanese companies operate EMD plants in Ireland and Greece, with a combined capacity of ca. 25 000 t/a.

In view of the rapid growth of the EMD market in the 1980s (averaging about 10%/a), considerable interest has been stimulated in establishing new EMD production plants. Thus, announcements regarding the construction of new facilities were recently made by BHP in Australia (15 000 t/a), Metalman in Brazil (12 000 t/a), and CIA Minera Autlan in Mexico (13 200 t/a).

According to [85], the 1986 world demand for EMD was about 128 000 t/a, and current production is said to be 165 000 t/a [84]. Serious EMD oversupply and fierce competition among producers is already evident, and is expected to intensify in the future.

#### 47.10.2.2 Other Oxides

**Manganese(II) oxide**, manganese monoxide, MnO, green, ρ 5.37 g/cm<sup>3</sup>, mp 1945 °C, is practically insoluble in water and occurs in nature as manganosite. It dissolves readily in most acids. Synthetic manganese monoxide is obtained by reduction of manganese dioxide or by thermal decomposition of Mn(II) carbonate under the exclusion of air. Depending on particle size (a function of the method of preparation), MnO reacts at varying rates with atmospheric oxygen even at room temperature, thereby forming Mn<sub>3</sub>O<sub>4</sub>.

Table 47.10: Major producers of electrolytic manganese dioxide (EMD).

| Country                     | Producer                           | Location             | Production capacity, 10 <sup>3</sup> t/a <sup>a</sup> | Anode material [82] |
|-----------------------------|------------------------------------|----------------------|---|---------------------|
| Japan                       | Toyo Soda                          | Hyuga                | 24  | Ti                  |
|                             | Mitsui Mining and Smelting         | Takehara             | 24  | Ti                  |
|                             | Dai-Ichi Carbon Company            | Yokohama             | 6   | C                   |
|                             | Japan Metals and Chemicals Company | Takaoka              | 18  | Ti                  |
| Greece                      | Tekkosha Hellas                    | Thessaloniki         | 15  | C                   |
| Ireland                     | Mitsui Denman                      | Cork                 | 12  | Ti                  |
| United States               | Kerr McGee                         | Henderston, NV       | 11  | C                   |
|                             | Eveready Battery Co.               | Marietta, OH         | 7   | C                   |
|                             | ESB Materials Company              | Covington, TN        | 3   | C                   |
|                             | Chemetals, Inc.                    | New Johnsonville, TN | 10  | Ti                  |
| Spain                       | Cegasa                             | Oñate                | 5   | Pb                  |
| Former Soviet Union         | state                              | Rustavi              | 5   | Pb                  |
| China                       | state                              |                      | 8   | C                   |
| India                       | Union Carbide                      | Thaha                | 3   | C                   |
|                             | T.K. Chemical                      | Trivandrum           | 1   | C                   |
| Brazil                      | Union Carbide                      | Itapericera          | 4   | C                   |
| South Africa                | Delta                              | Nelspruit            | 6   | Pb                  |
| <b>Total world capacity</b> |                                    |                      | <b>183</b>  |                     |

Compiled by Hoechst AG, 1987.

Manganese monoxide has major significance as an intermediate in the manufacture of Mn(II) compounds (especially manganese sulfate and sequential products) from MnO<sub>2</sub> ores. Reducing agents for MnO<sub>2</sub> in the large-scale manufacture of manganese monoxide include finely powdered coal, hydrogen, carbon monoxide, natural gas, and heavy fuel oils. The reaction is carried out at 400–800 °C in a rotary kiln or shaft furnace. The freshly formed manganese oxide must be allowed to cool in a reducing atmosphere in order to ensure room-temperature stability with respect to atmospheric oxygen.

Manganese monoxide (in contrast to manganese dioxide) is readily assimilated by most plants. This fact accounts for its widespread use as a fertilizer for manganese-deficient soils.

The consumption of manganese monoxide in the United States for fertilizer applications (alone or in combination with MnSO<sub>4</sub>) is about 20 000 t/a. A similar amount is used as an animal feed additive. Fertilizer/feed grade manganese monoxide (containing 77% MnO) is made by direct reduction of manganese ore.

High-purity manganese monoxide (obtained, for example, by reduction of 99.5% MnO<sub>2</sub>) is used in the production of specialty

ceramics and glasses for electronic applications, in ferrites and thermistors, and for making welding rod fluxes and high-purity manganese chemicals.

**Manganese(III) oxide**, Mn<sub>2</sub>O<sub>3</sub>, decomp. > 900 °C, ρ 4.89 g/cm<sup>3</sup>, exists in α- (rhombohedral) and γ- (tetragonal) modifications. The hydrate Mn<sub>2</sub>O<sub>3</sub>·H<sub>2</sub>O occurs as the mineral manganite and forms steel-gray, shiny, rhombic crystals. Manganese(III) oxide is made industrially from manganese dioxide by calcination at 600–800 °C, or by thermal decomposition and controlled air oxidation of manganese carbonate. Primary uses are the preparation of such electronic materials as ceramic magnets and semiconductors. It is a small-volume product, a few hundred tonnes are consumed annually.

**Manganese(II, III) oxide**, Mn<sub>3</sub>O<sub>4</sub>, mp 1562 °C, occurs naturally as hausmannite and crystallizes tetragonally (ρ 4.84 g/cm<sup>3</sup>). It may be obtained from the other manganese oxides by heating above 950 °C in the presence of air. According to a recently issued patent [86], high-purity Mn<sub>3</sub>O<sub>4</sub> can also be made from an aqueous suspension of finely divided manganese metal by air oxidation at 30–100 °C in the presence of ammonium salts. The compound forms black crystals, but finely dis-



persed it appears as a red powder. Highly purified  $Mn_3O_4$  is used in the manufacture of semiconductors and ceramic magnets. World production is estimated at ca. 2000 t/a.

**Other Manganese Oxides.** Oxides with penta-, hexa-, or heptavalent manganese have no industrial significance. Indeed, the hypothetical oxides  $Mn_2O_5$  and  $MnO_3$  have never been prepared. The anhydride of permanganic acid,  $Mn_2O_7$ , forms readily from  $KMnO_4$  and concentrated sulfuric acid. It is an unstable, highly explosive, green-black liquid.

### 47.10.3 Manganese(II) Salts

**Manganese acetate**,  $Mn(CH_3COO)_2 \cdot 4H_2O$ ,  $\rho$  1.589 g/cm<sup>3</sup>, forms pink crystals that are soluble in water, methanol, and ethanol. The compound dehydrates between 80 °C and 130 °C, and decomposes at 350 °C to  $Mn_2O_3$ . It is made industrially from acetic acid and either manganese carbonate, manganese(II) oxide, or electrolytic manganese metal. Its main use is as a catalyst (either alone or in combination with cobalt) in the liquid-phase air oxidation of hydrocarbons to carboxylic acids.

**Manganese borate**,  $MnB_4O_7 \cdot 8H_2O$ , is a white to pale reddish-white solid. It is insoluble in water and ethanol, but soluble in dilute acids. The compound is precipitated from aqueous solutions of manganese chloride and sodium borate, and is used as a siccative.

**Manganese(II) carbonate**,  $MnCO_3$ , light pink, decomp. > 200 °C,  $\rho$  3.125 g/cm<sup>3</sup>, occurs naturally as rhodochrosite. It is sparingly soluble in water (solubility product at 25 °C:  $8.8 \times 10^{-11}$ ) but readily soluble in acids. It is produced commercially from manganese sulfate by precipitation with alkali-metal carbonates or hydrogen carbonates. If the presence of alkali-metal ions must be avoided in the product (as in the manufacture of ferrites), ammonium hydrogen carbonate may be used as the precipitating agent. According to a German patent [87], the use of ferromanganese as a starting material results in manganese carbonate of especially high purity. The precipitated  $MnCO_3$  is filtered, washed, and dried at 110–

120 °C. Heating above 200 °C causes decomposition to  $MnO$  and  $CO_2$ .

Manganese carbonate is used in the synthesis of other manganese(II) salts (by reaction with the corresponding acids) and also in the production of battery-active, chemical manganese dioxide (CMD). Manganese carbonate is also important in the preparation of high-quality manganese zinc ferrites for the television and computer industries [63, p. 180]. World production of  $MnCO_3$  is estimated to be about 9000–10 000 t/a.

**Manganese(II) chloride**,  $MnCl_2$ ,  $\rho$  2.977 g/cm<sup>3</sup>, *mp* 690 °C, *bp* 1190 °C, is readily soluble in water and exists in the anhydrous form and as di-, tetra-, and hexahydrates. Unless precautions are taken (see below), thermal dehydration of the hydrates to the anhydrous form may result in some hydrolytic decomposition, with formation of gaseous HCl and manganese oxychloride.

Industrial preparation of manganese chloride is based either on the reaction of aqueous hydrochloric acid with  $MnO_2$  ore,  $MnO$ ,  $MnCO_3$  (rhodochrosite), or on direct chlorination of manganese metal or ferromanganese. The process currently employed in Bitterfeld (Germany) starts from manganese ore ( $MnO_2$ ). Chlorine gas is generated



and is absorbed in a suspension of hydrated lime [65, p. 739]. An alternative process used by Chemetals avoids the formation of chlorine by prerreduction of the  $MnO_2$  to  $MnO$ .

The  $MnCl_2$  solution thus obtained is purified by neutralization with  $MnCO_3$ , causing iron and aluminum impurities to precipitate. After filtration and evaporation, the tetrahydrate crystallizes from the cooled solution in plate-like crystals. This material, which is itself a commercial product, requires very careful drying because it melts at 58 °C in its own water of crystallization. Dehydration requires a temperature above 200 °C. Fusion in the oven is avoided by addition of previously dehydrated product. The drying process may be carried out in the presence of excess dry HCl

gas if anhydrous manganese chloride free of oxychlorides is required.

Uses of manganese(II) chloride include dry cell manufacture, preparation of hard and corrosion-resistant magnesium alloys, synthesis of methylcyclopentadienylmanganese tricarbonyl brick coloring [63, p. 182].

**Manganese(II) nitrate**,  $Mn(NO_3)_2$ , decomp. > 140 °C, exists in the anhydrous form and as mono-, tri-, tetra-, and hexahydrates. The commercial product is the tetrahydrate, which is readily soluble in water. Manganese nitrate is prepared by nitric acid treatment of manganese carbonate or  $MnO$ , or by reaction of  $MnO_2$  with nitric oxides. The compound is an important intermediate in the production of high-purity manganese oxides and is also used in the preparation of colorants for the ceramics industry.

**Manganese(II) phosphates.** The most important manganese phosphate is the water-soluble  $Mn(H_2PO_4)_2 \cdot 2H_2O$ , which is prepared by dissolving manganese carbonate, manganese(II) oxide, or manganese metal in phosphoric acid. This phosphate finds wide application in the phosphatizing of ferrous metals and is also used as a light stabilizer for polyamide fibers.

**Manganese(II) sulfate**,  $MnSO_4$ ,  $\rho$  3.25 g/cm<sup>3</sup>, *mp* 700 °C, *bp* 850 °C (decomp.), is almost pure white in the anhydrous state; the corresponding mono-, tetra-, penta-, and heptahydrates are pink. Manganese(II) sulfate is readily soluble in water, but has a strongly negative solubility coefficient at temperatures > 24 °C. The solids content of a manganese sulfate solution saturated at 24 °C is 39.3%; at 100 °C the solids content drops to 26.2%.

The customary commercial product (technical grade) is the monohydrate, containing 99%  $MnSO_4 \cdot H_2O$ . Manganese sulfate is produced either directly by reaction of manganese(II) oxide (or manganese carbonate) with sulfuric acid or as a by-product from organic oxidations with manganese dioxide.

Until recently the manufacture of hydroquinone (by oxidation of aniline with  $MnO_2$  and  $H_2SO_4$ ) was a major source of fertilizer-

grade manganese sulfate, containing 78%  $MnSO_4$  [88], but modern hydroquinone processes are based on either diisopropylbenzene/ $O_2$  or phenol and  $H_2O_2$ .

Before 1977 Tennessee Eastman, a major U.S. hydroquinone producer, operated with a by-product manganese sulfate capacity of about 35 000 t/a. Eastman's manufacturing technology has since been changed, and manganese sulfate is no longer produced. Other organic oxidations are still carried out with  $MnO_2$  as the oxidant (e.g., the manufacture of 4-*tert*-butylbenzaldehyde and *p*-anisaldehyde), but the output of manganese sulfate from these processes is no more than a few thousand tonnes per year, so the majority of U.S. manganese sulfate is now derived directly from  $MnO$  or  $MnCO_3$ .

Manganese sulfate is commercially one of the most important manganese products. It is the starting material for electrolytic manganese metal, electrolytic manganese dioxide, fungicides such as Maneb, and other manganese compounds including manganese carbonate, manganese soaps (naphthenate, linolate, and resinate, all used as siccatives), and certain inorganic pigments. Manganese sulfate is also used in textile printing and glass making. Very significant in terms of volume is the use of manganese sulfate as a fertilizer for manganese-deficient soils, for example, in the vegetable- and citrus-growing areas of Florida. It is also valuable as a micronutrient additive for animal feeds [63, p. 187].

World production of commercial manganese sulfate is estimated to be about 120 000–130 000 t/a. Production in the United States is ca. 8000 t/a, with a demand of approximately 14 000–14 500 t/a. The deficit is covered by imports from Europe and China.

Major producers of manganese sulfate include: Eagle Picher (USA), production capacity 6000 t/a; Sulfamex (Mexico) 21 000 t/a (start-up delayed); and Sedema (Belgium) 22 000 t/a. For more economic information on manganese sulfate, see [89].

## 47.10.4 Higher Oxidation-State Manganates

### 47.10.4.1 Potassium Manganates(V) and (VI)

**Potassium manganate(V)**,  $K_3MnO_4$ ,  $\rho$  2.78 g/cm<sup>3</sup>, decomp. > 1000 °C, occurs as fine blue-green to turquoise crystals. In the presence of water it is readily hydrolyzed, disproportionating to  $K_2MnO_4$ ,  $KMnO_4$ , and  $MnO_2$ . Solutions of  $K_3MnO_4$  in 40% potassium hydroxide have limited stability even below -10 °C; however, in the presence of 75% KOH and under nitrogen, potassium manganate(V) is stable up to 240 °C. Pure potassium manganate(V) can be heated to over 900 °C without decomposition. It is an important intermediate in the production of potassium permanganate.

**Potassium manganate(VI)**,  $K_2MnO_4$ ,  $\rho$  2.703 g/cm<sup>3</sup>, decomp. 640–680 °C, exists in the pure state as brilliantly green, rhombic crystals. Upon aging, the color changes to black-green due to the formation of a surface film of  $KMnO_4$ . The compound is less prone to decomposition than  $K_3MnO_4$ ; the deep green solutions in 15–20% potassium hydroxide (for solubilities in KOH see [90]) are quite stable even at 50–60 °C. In more dilute solutions, and especially in the presence of acid,  $K_2MnO_4$  disproportionates to  $KMnO_4$  and  $MnO_2$ . Pure potassium manganate(VI) is stable up to ca. 600 °C; at higher temperatures it loses oxygen to form  $K_3MnO_4$  and  $Mn_2O_3$ . By far the largest part of the  $K_2MnO_4$  produced industrially is converted to potassium permanganate; smaller quantities are used in the surface treatment of magnesium metal [91] and as a chemical oxidant [64, p. 175].

### 47.10.4.2 Potassium Permanganate

The best known of the manganates, potassium manganate(VII) (potassium permanganate) was introduced as a commercial product in 1862 [92]. It soon became a very important

chemical [93] not only industrially but also in the eyes of many generations of academic and industrial researchers. The former concerned themselves with the chemistry of  $KMnO_4$  and its precursors, while the latter devised new and improved methods for its production. Unraveling the chemistry of the higher valence states of manganese (generally referred to as manganates) proved to be a major challenge. Since 1954 the roles of the various manganates [especially manganate(V)] in the industrial production of  $KMnO_4$  have been fully clarified [94]. For more detailed historical information; see [95].

### Properties

Potassium manganate(VII)  $KMnO_4$ ,  $\rho$  2.703 g/cm<sup>3</sup>, decomp. > 200 °C, gives dark purple to bronze-colored rhombic crystals. Its solutions are faint pink to deep violet, depending on concentration. The solids content of a saturated aqueous solution at 20 °C is ca. 6%  $KMnO_4$  (11% at 40 °C and 20% at 65 °C). Permanganate solutions are most stable in the neutral or near-neutral pH region; acidic or alkaline solutions decompose with loss of oxygen. For solubilities in aqueous KOH see [90]. Potassium permanganate is also soluble in several organic solvents, including acetone, glacial acetic acid, methanol, and sulfolane (tetrahydrothiophene-1,1-dioxide). Such solutions usually have limited stability because the permanganate ion slowly attacks the solvent.

When dry potassium permanganate is heated to 200–300 °C, an exothermic, autocatalytic decomposition takes place with the evolution of oxygen. Contact with combustibles, especially water-soluble organic substances (such as polyhydroxy compounds), can lead to spontaneous ignition and potentially violent combustion.

The usefulness of permanganate as an oxidant is a result of several unique properties. One is the compound's ability to function as an oxidant at all pHs. Also interesting is the fact that permanganate oxidations can be carried out in both aqueous and several nonaque-

ous solvents. Phase-transfer catalysis greatly extends the range of usable solvents [96].

Permanganate oxidizes a wide variety of inorganic and organic compounds. It is often regarded as the oxidant of choice for olefins and aromatic side chains even though it can also interact with other functional groups [64, pp. 183–288; 97]. Permanganate oxidations can be used not only for specific modification of organic molecules but also to destroy such materials as in pollution abatement applications.

In moderately alkaline, neutral, or slightly acidic media,  $KMnO_4$  donates active oxygen according to the following equation:

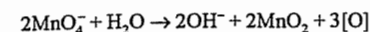

Only under substantially more acidic conditions, and with particular substrates, does permanganate oxidation follow an alternative course:

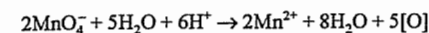

### Production [6, pp. 741–762]

Most permanganate is made from  $MnO_2$ -containing ore by fusion followed by electrolysis. However, all-electrolytic methods also exist. One such method, practiced in the Soviet Union since the late 1950s, involves direct single-step anodic oxidation of ferromanganese to permanganate [98]:



This process is not generally considered economical because of high energy consumption (about 15 kWh/kg), the high cost of preparing cast ferromanganese anodes, and the cost of cooling the electrolyte to the required operating temperature 20 °C.

In another patented all-electrolytic process [99] a 10–25% suspension of precipitated manganese dioxide in aqueous KOH is electrolyzed at  $\geq 60$  °C:



It is not clear whether this process is, or has been, used commercially.

### Fusion Processes [100]

The industrial preparation of potassium permanganate and its precursors ( $K_3MnO_4$  and  $K_2MnO_4$ ) begins with a finely ground  $MnO_2$  ore which is subjected to alkaline oxidative fusion:

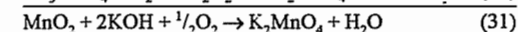
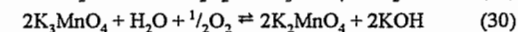
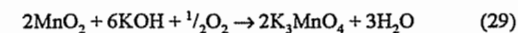

In a separate step, potassium manganate(VI) is subsequently converted to potassium permanganate, usually by anodic oxidation.

Several continuous or batch-type fusion processes are in current use, but they may be categorized in two groups:

- *Roasting processes* that employ a  $MnO_2$ :KOH molar ratio of 1:2 to 1:3 (the reaction mixture is a solid).
- *Liquid-phase processes* with a  $MnO_2$ :KOH molar ratio  $\geq 1:5$ .

**Roasting processes** usually involve two steps, with reactions (29) and (30) carried out sequentially. In the primary step, finely ground manganese dioxide is mixed with 50% KOH (frequently in a highly dispersed form) and treated with air or oxygen at 300–400 °C. The KOH/ $MnO_2$  reaction mixture is usually introduced as a fine spray into internally or externally heated rotary kilns (Figure 47.17). Stationary spray drier-like reactors are also in use. Most of the water quickly evaporates, and the highly concentrated KOH reacts within a few minutes with  $MnO_2$  and oxygen to form  $K_3MnO_4$  (Equation 29). The dry, blue-green reaction product is ground to increase its surface area and then subjected to secondary oxidation (Equation 30), in which it is exposed to a moisture-laden air or oxygen stream at 190–210 °C. Several hours are required to effect nearly complete conversion to the black-green  $K_2MnO_4$ .

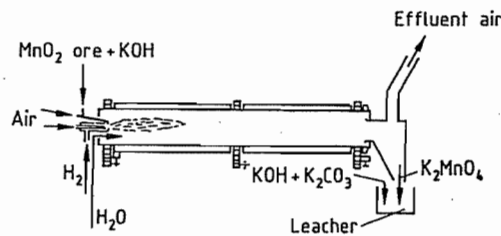

Figure 47.17: Rotary kiln with internal heating for the production of potassium manganate(VI).

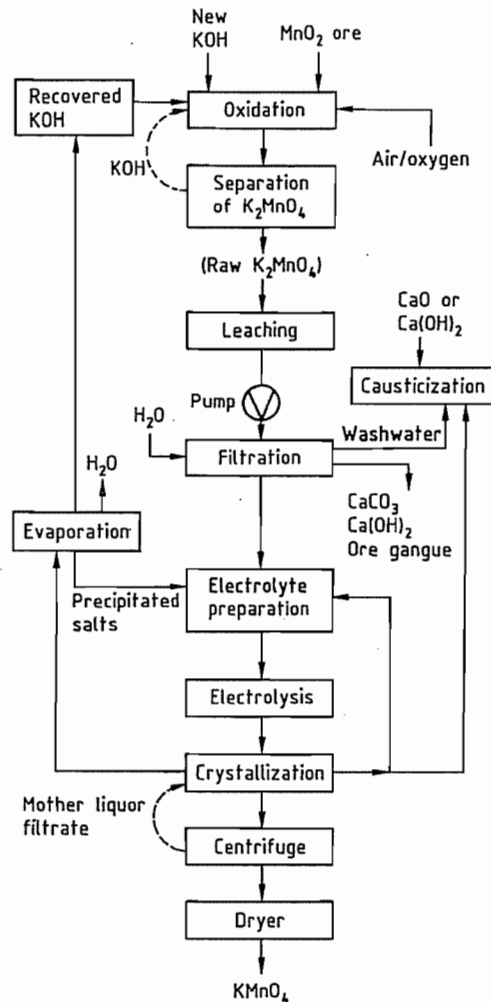

Figure 47.18: Production of potassium permanganate: liquid-phase oxidation process (overall flow schematic).

Rotary kilns are commonly employed for this step, but other types of solid gas contactor

(e.g., specially designed "plate" reactors) are also utilized. The removal of hard crusts that form on the inner walls of the reactor can cause substantial downtime.

**Liquid-Phase Processes.** In liquid-phase processes (Figure 47.18) finely ground  $\text{MnO}_2$  ore is added to an excess of concentrated, molten potassium hydroxide (70–90%) at 200–350 °C. The reaction mixture is agitated vigorously and a stream of finely dispersed air or oxygen is passed through the molten mass. The  $\text{MnO}_2$  is converted to  $\text{K}_2\text{MnO}_4$  in a single step (Equation 31), although such an oxidation can also be effected in two stages [101–103]. Potassium manganate(VI) crystallizes from the melt, from which it must then be separated by suitable means (e.g., thickening, decantation, filtration, and centrifugation) [104, p. 870].

#### Anodic Oxidation of Manganate(VI)

Oxidation of the manganate(VI) to permanganate is always accomplished by electrolysis:

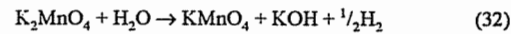

Crude manganate from the fusion process is first leached in dilute potassium hydroxide (90–250 g KOH per liter, depending upon the nature of the subsequent electrolysis). The resulting leach solution is usually filtered to separate insolubles, originating from the gangue portion of the ore (Figure 47.18).

Effective control of key parameters is decisive for the overall success of the electrolysis, including the concentrations of  $\text{K}_2\text{MnO}_4$ ,  $\text{KMnO}_4$ , and  $\text{KOH}$ , as well as the temperature (usually ca. 60 °C).

**Cell Design.** Typical electrolysis cells employ voltages of 2.3–3.8 V and anodic current densities of 50–1500  $\text{A}/\text{m}^2$ . Current yield depends on cell design and mode of operation, and ranges from 40–90%. Nickel or Monel Metal are the preferred materials for the anode, whereas iron is usually the metal of choice for the cathode.

Cells may be either monopolar or bipolar, rectangular or circular, and may be designed for either flow-through or batch operation.

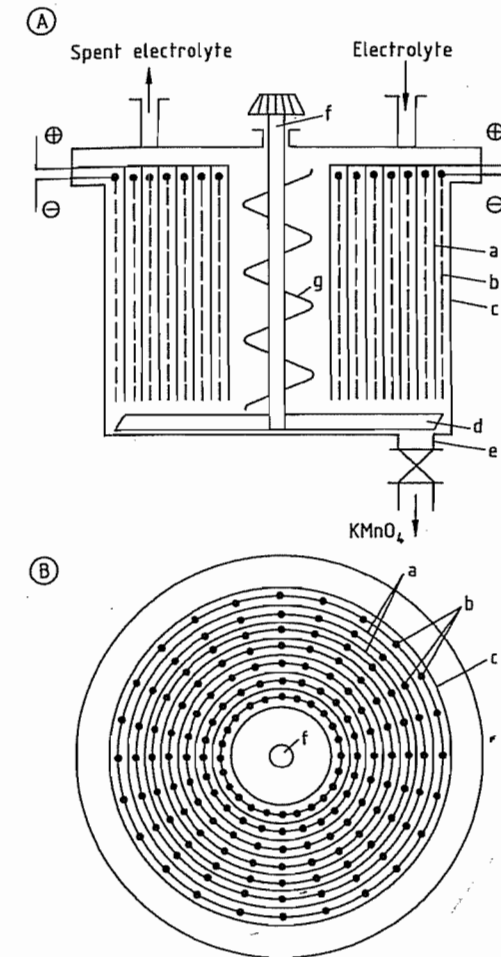

Figure 47.19: Electrolytic cell used in the Bitterfeld (Germany) process for the production of potassium permanganate. A) Vertical section; B) Cross section. a) Anode; b) Cathode; c) Rubber-lined cell trough; d) Agitator; e) Bottom discharge valve; f) Agitator shaft; g) Spiral agitator.

Cells used by the Chemiekombinat Bitterfeld in Germany [65, p. 749] (Figure 47.19), for example, have a volume of about 4  $\text{m}^3$ , are circular in shape, and are equipped with a built-in mechanical agitator. The electrode system is monopolar. These batch-operated cells use unfiltered electrolyte; the resulting  $\text{KMnO}_4$  is allowed to crystallize within the cells and is drawn off periodically through a bottom valve. The crude product must be re-

crystallized to separate it from residual ore gangue.

In the cell developed by the Carus Chemical Company, numerous bipolar electrodes are combined in an arrangement resembling a filter press to form a closed, diaphragm-less, flow-through electrolyzer (Figure 47.20) [105–107]. The anodic side of each cell sheet consists of Monel Metal screens while the effective cathode area consists of a multitude of small steel protrusions. The rest of the cathode is covered with a corrosion-resistant insulating material. A lower surface area for the cathode than for the anode maximizes the anodic oxidation of  $\text{MnO}_4^{2-}$  and minimizes undesirable cathodic reduction of both manganate and permanganate. The resulting potassium permanganate is crystallized outside the carus cell in a continuous crystallizer system.

**Crystallization.** Crystallization of potassium permanganate is effected either directly in a specially designed electrolytic cell or in separate crystallizers. Modern installations use single- or multistage vacuum crystallizers, which produce a crystalline product directly from the mother liquor in such purity that only centrifugation and drying are required before the  $\text{KMnO}_4$  is packaged and sold (Figure 47.21).

**Removal of Impurities and Recycling.** When the crude manganate is leached with dilute  $\text{KOH}$  a solid residue remains. This is composed of the insoluble portion of the ore gangue (e.g., iron oxide hydrates, precipitated aluminum silicate), unreacted  $\text{MnO}_2$  ore, and some precipitated  $\text{MnO}_2$  (from disproportionation of  $\text{K}_2\text{MnO}_4$ ). These insoluble constituents are removed by the use of thickeners, vacuum filters, or filter presses. The Bitterfeld process operates with unfiltered electrolyte, but here the electrolyzers have been specially designed to cope with suspended matter.

In order to recycle potassium hydroxide generated in the electrolysis step (Equation 32), the spent mother liquor is first concentrated by evaporation to a relative density of ca. 1.575–1.585. This "recovered" caustic potash is then recycled to the front end of the pro-

cess and added to either the roaster or the liquid-phase oxidizer. Alternatively, after removal of dissolved impurities, the recovered KOH can be treated with carbon dioxide to produce potassium carbonate. This method has the drawback that there is a limited market for the substantial quantities of potassium carbonate coproduct.

Dissolved impurities (in particular silicate and aluminate from the gangue portion of the ore) must be removed from the process liquors in order to avoid formation of rock-like deposits on pipeline and equipment walls. Equally undesirable is the buildup of carbonate in the process liquors due to reaction of atmospheric  $\text{CO}_2$  with KOH. Excessive carbonate concentrations in the recycle system reduce the rate of conversion of ore into manganates and can

also cause low current efficiencies in the electrolytic cell.

All three major impurities (Si, Al, and carbonate) can be removed together with such minor impurities as Cu, Pb, Ni, and Co by treatment with calcium hydroxide [108]. Effective causticization of the potassium carbonate occurs according to

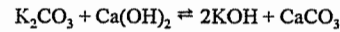

and requires that the potassium hydroxide concentration be kept  $< 80 \text{ g/L}$ . The process used by Nippon Chemical Industrial Company [109] entails addition of  $\text{Ca}(\text{OH})_2$  as early as the roasting step to prevent formation of soluble carbonate and the solubilization of other impurities.

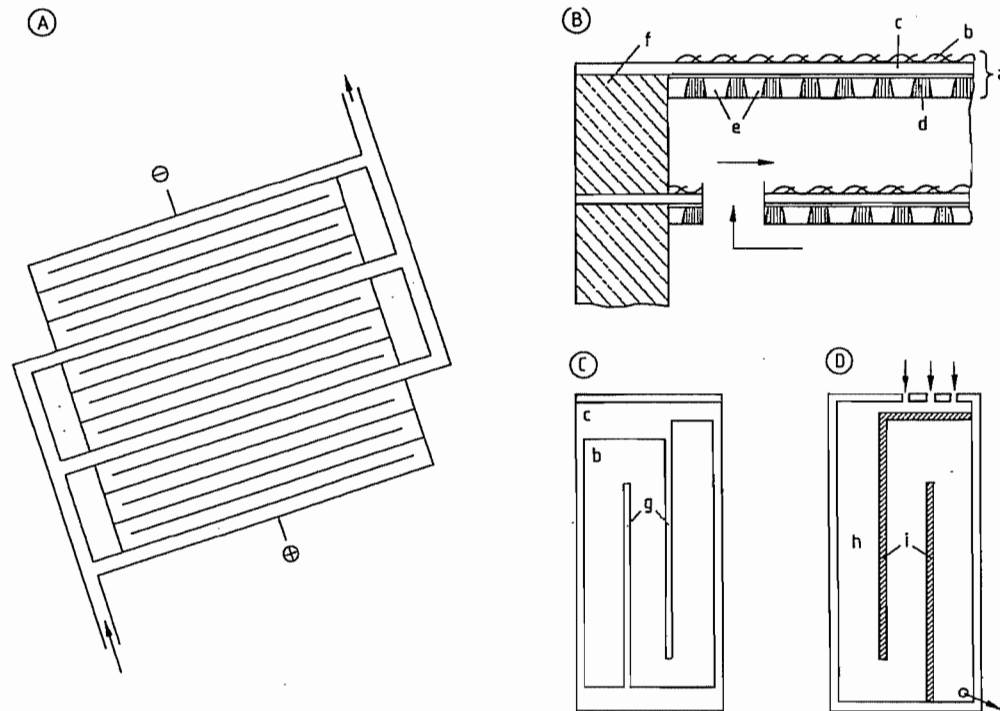

**Figure 47.20:** Carus Chemical electrolytic cell for the production of potassium permanganate from potassium manganate(VI) [106]. A) Schematic overview of the cell bank; b) Side elevation of an individual cell section; C) Cross section of the anode side of a bipolar electrode; D) Cross section of the cathode side of a bipolar electrode. a) Individual bipolar electrode; b) Anode (wire screen of Monel Metal); c) Base steel sheet; d) Steel cathode with perpendicular projections; e) Insulating plastic; f) Insulating spacer; g) Cutout for flow dividers; h) Cathode projections embedded in plastic; i) Flow dividers.

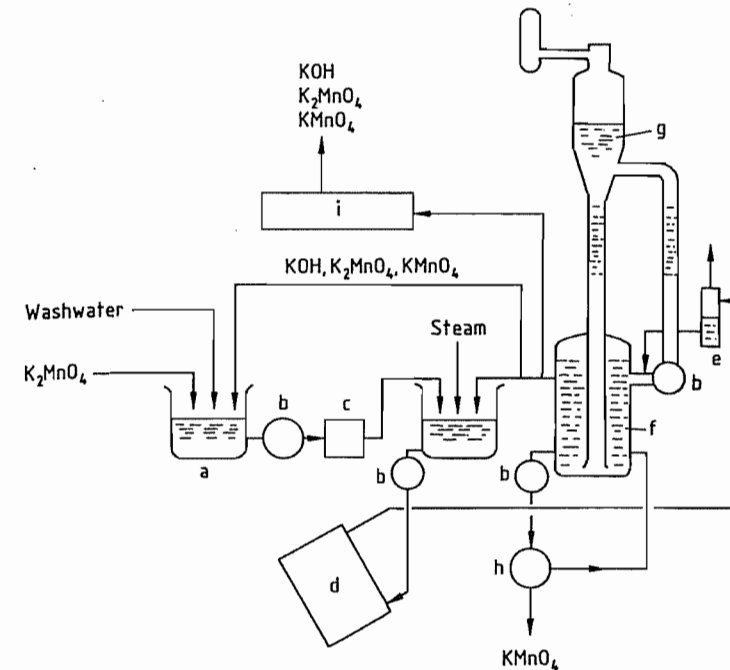

**Figure 47.21:** Production of potassium permanganate: continuous electrolyzing-crystallizing system: a) Leach tank; b) Pump; c) Filter; d) Electrolysis cell; e) Gas separator; f) Crystallizer; g) Vacuum evaporator; h) Centrifuge; i) Evaporator.

**Waste Disposal.** The treatment and disposal of solid wastes from permanganate production is an ecological as well as an economic problem. The waste product contains not only unreacted ore but also some-precipitated  $\text{MnO}_2$ . The main constituents are derived from the insoluble portion of the ore gangue (Fe, Si, Al compounds) but these are accompanied by significant quantities of potassium and calcium salts. One permanganate producer has proposed recovering most of the adsorbed and chemically-bound potassium by treatment with calcium hydroxide. After washing, the treated waste could then be deposited in landfills [110]. The patent literature describes a number of potential uses for the waste from permanganate production, including extraction of residual manganese, or use of the waste as an absorbent for air pollutants [111], as a micronutrient additive for fertilizers [112], or in building materials [113].

### Production Plants

This section gives a brief review of production plants for potassium permanganate in eight countries. Most of the reported production capacities are estimates.

**Germany.** The VEB Chemiekombinat Bitterfeld was built in 1920 and modernized recently (capacity 5000 t/a) [114]. Potassium manganate is produced by a two-stage roasting process. Electrolytic oxidation and crystallization of the resulting potassium permanganate occur in cylindrical, monopolar, batch-type cells.

**India.** Permanganate production began in India after World War II. Only one plant remains, that of Curti Chemicals (Goa) built in 1970 with a capacity of less than 1000 t/a. It uses a roasting step followed by electrolytic oxidation.

**Spain.** The Spanish permanganate plant in Trubia was established in 1940 and modernized in 1977. The plant is operated by As-

turquímica and capacity is 4000 t/a. A modified spray drier is used as the reactor in the first roasting step and a "plate" reactor for the second roasting step [115]. Electrolytic oxidation and vacuum crystallization occur continuously.

**Japan.** Nippon Chemical constructed a new, continuously operating plant in Aichi Prefecture in 1971 (capacity ca. 3000 t/a). An improved roasting process is employed for making the manganate intermediate, whereby the  $MnO_2$ -KOH reaction mixture containing hydrated lime is dewatered in a separate step before it is introduced into the two-stage roaster system [109]. The electrolysis cells are arranged in cascade fashion and overflow from the final stage is passed to a vacuum crystallizer.

**Former Soviet Union.** The former Soviet Union operates three plants, built in the late 1950s and early 1960s. The plant in Rustavi has a capacity of 500 t/a and employs single-step anodic oxidation of ferromanganese [104, p. 875]. The second plant, in Saki, has a capacity of about 2500 t/a and uses technology similar to that of the Bitterfeld plant in Germany. The third plant is also in Saki and has a capacity of about 3000 t/a. It uses discontinuous liquid-phase oxidation in the manganate step [104, p. 870], followed by batch electrolysis and crystallization.

**Former Czechoslovakia.** The Czech plant (Spolek pro Chimickou a Hutní Vyrobu n.p., Usti n.L.) was built in the 19th century. It uses a two-stage roasting process with rotary hearth furnaces for the manganate step. Conversion of each batch of  $MnO_2$  to  $K_2MnO_4$  requires ca. 48 h. The monopolar, continuously operating electrolytic cells contain asbestos diaphragms and electrodes. Plant capacity in 1981 was stated to be 2000 t/a [116].

**China.** China, with ten state-owned plants, has become a major factor in the world permanganate market, especially as an exporter. Estimates of production capacity range from 7000–15 000 t/a. The largest most modern installation (with production of ca. 3000 t/a), es-

tablished in 1954 in Guangzhou, Canton, presumably uses a liquid-phase oxidation process in the manganate step. The other (smaller) plants are said to employ roasting methods.

**United States.** The Carus Chemical Company of La Salle, Illinois, has been a producer of potassium permanganate since 1915. New production technology was developed and installed during the late 1950s and early 1960s when patented processes included liquid-phase oxidation in the manganate step [101–103] and closed bipolar cells with continuous crystallization in the permanganate step [105–107]. Numerous improvements have since been introduced, and the current process is fully continuous, highly automated, and in full compliance with environmental regulations. Production capacity is ca. 15 000 t/a.

### Commercial Grades, Packaging, and Transportation

Potassium permanganate is offered in several standard grades, including technical, technical free-flowing, U.S.P., and reagent. Guaranteed assays for the various products range from 97%  $KMnO_4$  for the free-flowing grade (which contains an anticaking additive) to 98% for the technical grade and 99% for both U.S.P. and reagent grades (typical assays are usually approximately 0.5% above the guaranteed levels). In addition to assay requirements, reagent grade and U.S.P. grade potassium permanganate conform to specifications set forth in the U.S.P. [117] and the 7th Edition of Reagent Chemicals [118], respectively. Additional specialty grades are also available. Material intended for drinking water treatment must conform, for example, to NSF Standard 60 [119] in the United States and to DIN 19619 [120] in Germany. Packaging is in steel drums or, for large users, bulk containers, bulk cars, and trucks.

The following transportation regulations are applicable: IMDG code D 5187, class 5; RID/ADR class 5.1, number 9c; UN no. 1490; CFR 49:172.101 oxidizing material.

### Uses

The United States is the leading consumer (followed by Western Europe and Japan) of permanganate intended for environmental applications, such as drinking water treatment (removal of tastes, odors, iron, and manganese [121]; control of trihalomethanes [122]); wastewater treatment (destruction of hydrogen sulfide [123] and other toxic and/or corrosive compounds, including phenols [124] and plating wastes [125]); and air purification (degradation of malodorous or toxic constituents in industrial off-gases) [126].

In other parts of the world (particularly Eastern Europe and India), the principal use of potassium permanganate is in chemical processing, especially the manufacture of synthetic organics (e.g., saccharine, chloroamphenicol, ascorbic acid, isonicotinic acid, pyrazinoic acid). Even in the Western world, chemical processing applications are significant. Thus, numerous intermediates for pharmaceuticals and pesticides are made via permanganate oxidation, as are many fine organics, including flavoring. Significant tonnage is also consumed for the oxidative destruction or precipitation of undesirable impurities, often ones that impart unwanted colors or odors.  $KMnO_4$  is used in the purification of such chemicals as methanol, ethanol, acetic acid, caprolactam, adiponitrile, plasticizers, carbon dioxide for dry ice manufacture, zinc chloride, and hydrofluoric acid. In recent years,  $KMnO_4$  has played a major role in the bleaching of indigo and other dyes for cotton twill fashion garments. This involves processes known as "frosting", "icing", or "acid washing". Permanganate is also used for bleaching beeswax, natural sponges, jute fibers, and certain clays.

Other important uses include surface treatment of carbon steels and stainless steels (descaling and desmutting, especially in wire manufacture), etching of rubber and plastics, and decontamination of nuclear reactors. Fish farmers utilize  $KMnO_4$  to prevent oxygen depletion and to control fish parasites.

### Economic Aspects

Even though potassium permanganate is not a large-volume chemical it is industrially very important. Especially in the manufacture of specific organic intermediates  $KMnO_4$  is an indispensable oxidant.

World production capacity for potassium permanganate is estimated to be 43 000–51 000 t/a, although actual demand is less than 30 000 t/a. Most of the idle capacity is to be found in countries with free market economies: the United States, Western Europe, and Japan. Two of the three West European permanganate plants have been shut down since 1975: Rhône Poulenc's installation in France and the Boots Company plant in the United Kingdom.

Much of the permanganate output from countries with controlled economies enters Western markets at very low prices as a result of extremely low labor costs and virtually no environmental overhead. Government-imposed antidumping duties provide some relief, but not enough to ensure competition on a comparable-cost basis between the imported and domestic product.

#### 47.10.4.3 Sodium Permanganate

Many permanganates other than  $KMnO_4$  are known [103, pp. 859–860], but only sodium permanganate is currently of industrial significance.  $NaMnO_4 \cdot H_2O$ ,  $\rho$  1.972 g/cm<sup>3</sup>,  $mp$  36.0 °C, can be made in several ways, including anodic oxidation of ferromanganese in  $Na_2CO_3$  solution [65, p. 759], via aluminum permanganate [127], or from  $KMnO_4$  by the hexafluorosilicate method [128]. The price of sodium permanganate is about 5 to 8 times that of  $KMnO_4$ . This is mainly due to the fact that  $NaMnO_4$  cannot be made in the same way as  $KMnO_4$ , because the oxidation of  $MnO_2$  in a NaOH melt does not lead to the required  $Na_2MnO_4$  (with hexavalent Mn) but only to  $Na_3MnO_4$  with pentavalent Mn. The latter is very unstable in dilute NaOH solution (and therefore cannot be converted electrolytically to the desired  $NaMnO_4$ ). Even if electrolytic

oxidation were possible, there would still be the difficult problem of isolating the extremely soluble  $\text{NaMnO}_4$  from the alkaline mother liquor.

Sodium permanganate is readily soluble in water (900 g/L at ambient temperature) and is preferred for applications requiring high concentrations of the  $\text{MnO}_4^-$  ion. Thus,  $\text{NaMnO}_4$  is used in the etching of plastic parts such as printed circuit boards [129], as well as in some special organic oxidation reactions, particularly if the presence of potassium ions is undesirable.

#### 47.10.5 Miscellaneous Compounds

*Manganese(III) fluoride*,  $\text{MnF}_3$ ,  $\rho$  3.54 g/cm<sup>3</sup>, is a red crystalline material, thermally stable to 600 °C, that is obtained by reacting Mn(II) halides with elemental fluorine at 200 °C. It decomposes in water and is used as a fluorinating agent for organic compounds.

*Manganese hypophosphite*,  $\text{Mn}(\text{H}_2\text{PO}_2)_2 \cdot \text{H}_2\text{O}$ , is soluble in water, forms pink, odorless crystals, and decomposes spontaneously upon heating to flammable phosphine. It is prepared from calcium hypophosphite and manganese sulfate. The compound is used as a stabilizer to improve the heat and light resistance of certain man-made fibers and as a food additive and dietary supplement.

*Manganese(III) acetylacetonate*,  $\text{Mn}(\text{C}_5\text{H}_7\text{O}_2)_3$ ,  $mp$  172 °C, is a brown to black crystalline solid that is insoluble in water but soluble in organic solvents. In the dry state it is relatively stable. It is synthesized by reacting manganese(III) sulfate, acetylacetone, and ammonia in an aqueous medium, and is used industrially as a catalyst for organic reactions (e.g., in the polymerization of 2-hydroxyethyl methacrylate to a soluble polymer [130]).

*Manganese ethylenebis(dithiocarbamate)*, Maneb,  $(\text{CH}_2\text{NHCS}_2)_2\text{Mn}$ , is a yellow powder. It is prepared by the addition of an aqueous solution of ethylene diamine and ammonia to carbon disulfide, followed by neutralization with acetic acid and precipitation with  $\text{MnSO}_4$

or  $\text{MnCl}_2$ . The compound is an important fungicide.

*Methylcyclopentadienylmanganese tricarbonyl* (MMT),  $\rho$  1.39 g/cm<sup>3</sup>,  $bp$  233 °C, is a yellow liquid that is insoluble in water but soluble in organic solvents. Several synthetic routes exist for this compound. For example, manganese(II) chloride may be allowed to react with cyclopentadienylmagnesium bromide,  $\text{C}_5\text{H}_4\text{MgBr}$ , to form bis(cyclopentadienyl)manganese, an intermediate that reacts with carbon monoxide to give the tricarbonyl. This is then methylated in the presence of Friedel-Crafts catalysts. The product finds limited use as an antiknock additive in motor fuels and as a combustion aid in heating oils.

#### 47.10.6 Occupational Health and Environmental Aspects

Manganese plays an important biochemical role in animal and plant life, and is regarded as an essential trace element [131]. It is added as a fertilizer (in the form of  $\text{MnO}$  or  $\text{MnSO}_4$ ) to manganese-deficient soils and is also a constituent in dietary supplements for animals and humans.

The United States Food and Drug Administration has given GRAS (Generally recognized as safe) clearance to manganese chloride, manganese citrate, manganese gluconate, and manganese sulfate as direct human food ingredients [132]. Nevertheless, excessive intake and long-term exposure, especially to airborne manganese, can lead to toxic effects [133–136]. Acute poisoning with manganese compounds in humans is very rare, but a few cases involving potassium permanganate are mentioned in the literature, either in connection with its attempted use as an abortifacient (abortifacient) or in cases of attempted suicide. The human LDLo for  $\text{KMnO}_4$  is reported to be 143 mg/kg, with a TDLo for women of 2400 mg kg<sup>-1</sup> d<sup>-1</sup> [137].

Chronic manganese poisoning is of much greater concern [138]. Inhalation of manganese in the form of oxidic dust or as vaporized metal over extended periods of time (3 months to several years) increases susceptibility of the

respiratory organs to infection (manganese pneumonia). Manganese can also cause permanent damage to the central nervous system (manganism). The hazard of chronic manganese poisoning affects not only workers in manganese mines and manganese ore crushing/grinding facilities but also those employed in various manganese-consuming industries (e.g., the production and use of ferro- and silicomanganese in steelmaking, welding with manganese-containing welding rods, dry cell manufacture, and production of manganese chemicals) [139, 140]. The early symptoms of manganism are classed as psychological disturbances: fatigue, loss of appetite, incoordination, speech disorders, and psychotic behavior. Manganism at this stage is reversible provided exposure ceases. Continued exposure causes the disease to enter a second stage, in which permanent injury is inflicted on the central nervous system. Symptoms include severe rigidity of the limbs with jerky movements, gait problems, tremors, and excessive salivation and perspiration. There is some similarity between the symptoms of manganism and those of Parkinson's disease.

In the United States, Germany, Switzerland, and Japan a general ceiling value (MAK) has been set for manganese in air at 5 mg/m<sup>3</sup>. The ceiling value for  $\text{Mn}_3\text{O}_4$  is 1 mg/m<sup>3</sup> [141]. OSHA has recently proposed lowering the "Permissible Exposure Limit" to manganese at the workplace to 1 mg/m<sup>3</sup> [142]. On the other hand, the United States Environmental Protection Agency decided not to designate manganese as a hazardous air pollutant under the Clean Air Act, mainly because public exposure to manganese is far below levels associated with serious noncarcinogenic health effects, and available data do not indicate that manganese is carcinogenic [143].

Detailed information about the location of major manganese air emission sources in the United States can be found in [144]. At current exposure levels, manganese does not constitute a general environmental risk [141]. The limit for manganese in drinking water in the United States and most West European countries is 0.05 ppm. This low value is based

largely on aesthetic rather than toxicological considerations [145].

#### 47.11 References

1. J. S. Stanko: *Manganese for Steelmakers*, Council for Mineral Technology, Johannesburg, South Africa 1989.
2. S. A. Weiss: *Manganese – the Other Uses*, The Garden City Press Ltd., Letchworth 1977.
3. E. A. Brandes, R. F. Flint: *Manganese Phase Diagrams*, The Manganese Centre, Paris 1980.
4. O. Kubaschewski, E. L. Evans, C. B. Alcock: *Metallurgical Thermochemistry*, Pergamon Press, Oxford 1967.
5. L. Habraken: "Manganese – an Alloying Agent", *Proc. Semin. Non Ferrous Applications of Manganese*, The Manganese Centre, Paris 1977.
6. B. McMichael: "Manganese, EMD – the Power in the Market", *Ind. Miner.* (1989) May, 42–59.
7. J. F. Machamer: "A Working Classification of Manganese Deposits", *Min. Mag.* 157 (1987) no. 10, 348–351.
8. *Manganese Ores Analysis*, The Manganese Centre, Paris 1986.
9. A. S. E. Kleyenstuber: "The Correlation of the Mineralogy with the Sedimentary Cycles of the Proterozoic Manganese-Bearing Hotazel Formation in South Africa", *IAS Int. Symp. Sedimentology Related to Mineral Deposits*, 30th July–4 August 1988, Beijing.
10. C. J. Nel, N. J. Beukes, J. P. R. de Villiers: "The Mamatwan Manganese Mine of the Kalahari Manganese Field", in C. R. Anhaeusser, C. R. Maske (eds.): *Mineral Deposits of Southern Africa*, vol. 1, Geol. Soc. S. Afr., Johannesburg 1986, pp. 963–978.
11. S. Roy: *Manganese Deposits*, Academic Press, London 1981.
12. I. M. Varentson, G. Y. Graselly: *2nd International Symposium on the Geology and Geochemistry of Manganese*, Schweitzerbart'sche Verlagsbuchhandlung, Stuttgart 1980.
13. D. B. Wellbeloved: "Manganese in South Africa – an Overview", *Conference on Base Metals*, Johannesburg, May 17, 1988.
14. *Manganese Statistical Bulletin 1987*, The Manganese Centre, Paris 1988.
15. M. P. Sassos: "Manganese GFMCO Mines Huge Resources at Groote Eylandt", *Eng. Min. J.* 185 (1984) 57–58.
16. A. R. Chernenko, A. S. Sidorov: "Updating the Technology and Machinery for Underground Manganese Ore Mining", 12th World Mining Congress, New Delhi 1984.
17. M. C. Fuerstenaue, K. N. Han, J. D. Miller: "Flotation Behaviour of Chromium and Manganese Minerals", in P. Somasundaran (ed.): *Advances in Mineral Processing*, Society of Mining Engineers, Littleton 1986, pp. 289–307.
18. J. Chen, D. Chen, T. Chen, S. Liu: "Technological Innovations and Theoretical Approach to Shear Washing for a Refractory Manganese Ore", *Zhongnan Kuangye Xueyuan Xuebao* 19 (1988) no. 4, 371–378.

19. O. Holta, S. E. Olsen: "Composite Briquettes of Manganese Ore and Coal", *Electr. Furn. Conf. Proc.* **43** (1986) 273-277.
20. K. P. Abraham, M. W. Davies, F. D. Richardson: "Determination of Manganese Oxide in Silicate Melts", *J. Iron Steel Inst. London* **196** (1960) 82-86.
21. F. D. Richardson: *Physical Chemistry of Melts in Metallurgy*, vol. 2, Academic Press, London 1974, p. 333.
22. I. Barin, O. Knacke: *Thermodynamic Properties of Inorganic Substances*, Springer Verlag, Berlin 1974.
23. J. H. Downing: "Fundamental Reactions in Submerged Arc Furnaces", *Electr. Furn. Conf. Proc.* **19** (1963) 288-296.
24. S. A. Weiss: *Manganese the Other Uses. A Study of the Non-Steelmaking Applications of Manganese*, Metal Bulletin Books Ltd. London 1977.
25. J. W. Mellor: *A Comprehensive Treatise on Inorganic and Theoretical Chemistry*, vol. XII, Longmans, London 1972.
26. E. C. Snelling: *Soft Ferrites, Properties and Applications*, 2nd ed., Butterworths, London 1988.
27. J. H. Jacobs et al.: "Operation of Electrolytic Manganese Pilot Plant, Boulder City, Nevada", *U.S. Dep. Inter. Bull.* **463** (1948).
28. G. L. Hubred, R. T. Lewis, US 4317730, 1982.
29. T. I. Mercz, J. C. Madgwick: "Enhancement of Bacterial Leaching by Microalgal Growth Products", *Proc. Australas. Inst. Min. Metall.* **283** (1982) 43-46.
30. F. N. Bender, C. Rampacek: "Percolation Leaching of Manganese Ores With Sulphur Dioxide", *U.S. Dep. Inter. Rep. of Investigation* **5233** (1957).
31. P. K. Sahoo, S. C. Das, S. K. Bose, S. C. Sircar: "Separation of Iron From Manganese Ore Roast-leach Liquor", *J. Chem. Tech. Biotechnol.* **29** (1979) 307-310.
32. S. Joris: "La cinétique de précipitation des sulfures de cobalt et de nickel par l'hydrogène sulfuré", *Bull. Soc. Chim. Belg.* **78** (1969) 607.
33. P. M. Ambrose, US 2316750, 1943.
34. J. Koster, US 2483287, 1949.
35. E. M. Wanamaker, W. D. Morgan, US 2325723, 1943.
36. P. M. Ambrose, US 2347451, 1944.
37. J. J. Harper, US 4311521, 1982.
38. J. E. Reynolds, N. J. Lombardo, US 4423012, 1984.
39. The Consolidated Mining and Smelting Company of Canada Ltd., GB 540228, 1939.
40. M. Harris, D. M. Meyer, K. Auerswald: "The Production of Electrolytic Manganese in South Africa", *J. S. Afr. Inst. Min. Metall.* **77** (1977) Feb. 137.
41. A. I. Vogel: *A Text Book of Quantitative Inorganic Analysis, Including Elementary Instrumental Analysis*, 3rd ed., Longmans, London, p. 953.
42. J. K. Tuset: "Silicothermic Reduction of Manganese", *Steelmaking Conf. Proc.* **69** (1986) 59-64.
43. M. M. Bourgeois: "Les alliages de manganèse à bas carbone: silicomanganèse et ferromanganèse", *Rev. Métall. (Paris)* (1979) June.
44. K. Venugopalan, M. Kamaludeen, N. G. Renganathan, V. Aravamuthan: "Massive Manganese Metal By Fused Salt Electrolysis", *Trans. Indian Inst. Met.* **33** (1980) no. 1, 79-81.
45. J. S. Stanko: *Steel Makers Guide to Manganese*, Mintek, Randburg 1989.
46. T. Chisaki, K. Takervchi: "Electric Smelting of High Carbon Ferromanganese with Preheated Pre-reduced Materials at Kashima Works", Kashima 1971.
47. D. S. Cronan: "Marine Mineral Resources", *Geol. Today* **1** (1985) no. 1, 15-19.
48. B. W. Haynes et al.: "Pacific Manganese Nodules, Characterization and Processing", *U.S. Bur. Mines Bull.* **679** (1985) 2-32.
49. V. E. McKelvey: "Subsea Mineral Resources", *U.S. Geol. Surv. Bull.* **1689-A** (1986) 72-95.
50. D. S. Cronan: "Manganese on the Ocean Floor", *Trans. Inst. Min. Metall. Sect. A* **94** (1985) July, 166-167.
51. W. D. Siapno: "Manganese Nodules: Overcoming the Constraints", *Mar. Min.* **5** (1986) no. 4, 457-465.
52. J. S. Chung: "Advances in Manganese Nodule Mining Technology", *Mar. Technol. Soc. J.* **19** (1985) no. 4, 39-44.
53. S. Wakabayashi, E. Kuboki, T. Saito, A. Takata, T. Linuma: "Research and Development Project of Manganese Nodule Mining System in Japan", *Proc. Fifth Int. Offshore Mechanics and Arctic Eng. Symp.*, Tokyo 1986.
54. D. C. Tolefson, J. P. Latimer, R. Kaufman: "Design Considerations for a Commercial Deep Ocean Mining System", *Proc. Fifth Int. Offshore Mechanics and Arctic Eng. Symp.*, Tokyo 1986.
55. S. B. Kanungo, R. P. Das: "Extraction of Metals from Manganese Nodules of the Indian Ocean by Leaching in Aqueous Solution of Sulphur Dioxide", *Hydrometallurgy* **20** (1988) no. 2, 135-146.
56. S. Anand, S. C. Das, R. P. Das, P. K. Jena: "Leaching of Manganese Nodules at Elevated Temperature and Pressure in the Presence of Oxygen", *Hydrometallurgy* **2** (1988) no. 2, 155-168.
57. C. T. Hillman, B. B. Gosling: "Mining Deep Ocean Manganese Nodules. Inf. Circ. No. 9015", *U.S. Dept. Inter. Bur. Mines*, Washington 1985, p. 1-15.
58. H. Bozon: "La future exploitation des nodules polymétalliques sous-marins", *JFE J. Four. Electr.* (1982) no. 9, 13-21.
59. Roskill Information Services: *The Economics of Manganese* 1989, 5th ed., 1989.
60. R. D. W. Kemmit: "Manganese" in J. C. Bailar, H. J. Emelius, R. Nyholm, A. F. Trotman-Dickenson (eds.): *Comprehensive Inorganic Chemistry*, vol. 3, Pergamon Press Ltd., Oxford 1973, pp. 771-876. *Gmelin*, System-Number 56, Mangan.
61. O. Glemser, G. Gattow, H. Meisiek, *Z. Anorg. Allg. Chem.* **309** (1961) 1-19.
62. R. Giovanoli, E. Stähli, *Chimia (Aarau)* **24** (1970) 49-61.
63. S. A. Weiss: *Manganese - The Other Uses. A Study of the Non-Steelmaking Manganese Trade and Industry*, Metal Bulletin Books, London 1977.
64. D. Arndt: *Manganese Compounds as Oxidizing Agents in Organic Chemistry*, Open Court Publishing Company, La Salle, IL, 1980.
65. H. Marcy: "Anorganische Manganverbindungen", in F. Matthes, G. Wehner (eds.): *Anorganisch-Technische Verfahren*, VEB Deutscher Vlg. für Grundstoffindustrie, Leipzig 1964.

66. A. D. Little, Inc.: *Recovery of Manganese from Low-Grade Domestic Sources*, Bureau of Mines Open File Report 201-84 (1985), National Technical Information Service, U.S. Department of Commerce, Springfield, VA, under PB85-119378.
67. A. J. Fatiadi: "The Oxidation of Organic Compounds by Active Manganese Dioxide", in W. J. Mijs, C. R. H. I. de Jonge (eds.): *Organic Syntheses by Oxidation with Metal Compounds*, Plenum Press, New York-London 1986, pp. 119-260.
68. Lambeg Industrial Research Association, US 3900425, 1975 (E. Robinson).
69. Carus Corporation, US 4299375, 1981; US 4304760, 1981 (P. G. Mein, A. H. Reidies).
70. Ullmann, 4th ed., **16**, 469.
71. Diamond-Shamrock Corp., US 3780158, 1973 (J. Y. Welsh).
72. E. Preisler, *Chem. Unserer Zeit* **14** (1980) no. 5, 137-148.
73. Manganese Chemicals Corp., US 2956860, 1960 (J. Y. Welsh).
74. E. Preisler, Hoechst AG, personal communication.
75. G. D. Van Arsdale, C. G. Meier, *Trans. Electrochem. Soc.* **33** (1918) 109.
76. A. Kozawa, I. Tanabe, *Proc. Electrochem. Soc.* **87** (1987) no. 14, (*Proc. Symp. Hist. Battery Technol.*, 1987), 39-46.
77. P. M. De Wolff, J. W. Visser, R. Giovanoli, R. Brüttsch, *Chimia* **32** (1978) 257-259.
78. E. Preisler, *Dechema Monographien* **102** (1986) 543-559; **109** (1987) 123-137.
79. K. v. Kordes: *Batteries, Manganese Dioxide*, vol. 1, M. Dekker Inc., New York 1974.
80. E. Preisler, A. Reidies: "Manganverbindungen", in *Winnacker-Küchler*, vol. 2, 1982, 633-650.
81. G. Kano, *Mem. Fac. Eng., Fukui Univ.* **34** (1986) no. 2, 163-172.
82. A. Kozawa: "New Materials and New Processes", in *New Materials and New Processes*, vol. 3, JEC Press Inc., Cleveland, OH, 1985, p. 36.
83. Japan Metals and Chemicals, DE 3046913 C2, 1987 (M. Misawa et al.).
84. K. E. Anthony, Broken Hill Proprietary Co., Melbourne, Australia, personal communication.
85. H. Takahashi, *Jpn. Chem. Week* **27** (1986) 8.
86. Kerr-McGee Chemical Corp., US 4812302, (W. C. Laughlin, D. A. Schulke).
87. H. J. Koch, F. Henneberger, DD 45071, 1966.
88. Ullmann, 4th ed., **16**, 472.
89. *Chem. Mark. Rep.*, Feb 15, 1988, 33; May 4, 1987, 50; Apr 23, 1984, 58.
90. R. Landsberg, P. Örgel, *Chem. Technol.* **13** (1961) 665-667.
91. H. A. Evangelides, US 2723952, 1952.
92. H. Cassebaum, *Pharmazie* **34** (1979) 740-744.
93. A. H. Reidies, *Water Conditioning and Purification*, 1987, 32-33.
94. R. Scholder, W. Klemm, *Angew. Chem.* **66** (1954) 463-465.
95. Ullmann, 4th ed., **16**, 473; 3rd ed., **12**, 229.
96. D. G. Lee: "Phase Transfer Assisted Permanganate Oxidations", in W. S. Trahanowski (ed.): *Oxidation in Organic Chemistry*, Academic Press Inc., New York 1980, Part D, pp. 147-206.
97. A. J. Fatiadi, *Synthesis* **1987**, no. 2, 85-127.
98. G. R. Popov, *Khim. Ind. (Sofia)* **4** (1968) 166-169; *Chem. Abstr.* **69** (1968) 1023326.
99. Nippon Chemical Industrial Company Ltd., US 3986941, 1976 (T. Okabe, E. Narita, Y. Kobayashi, M. Mita).
100. W. Baronius, J. Marcy, *Chem. Techn.* **18** (1966) 723-727.
101. Carus Chemical Company, US 2940821, 1960 (M. B. Carus, A. H. Reidies).
102. Carus Chemical Company, US 2940822, 1960 (M. B. Carus, A. H. Reidies).
103. Carus Chemical Company, US 2940823, 1960 (A. H. Reidies, M. B. Carus).
104. A. H. Reidies in *Kirk-Othmer*, **14**, 844-895.
105. Carus Chemical Company, US 2843537, 1958 (M. B. Carus).
106. Carus Chemical Company, US 2908620, 1959 (M. B. Carus).
107. Carus Chemical Company, US 3062734, 1962 (M. B. Carus).
108. Carus Chemical Company, US 3172830, 1965 (M. B. Carus).
109. Japan Chemical Industrial Company, JP 7230520, 1972 (S. Takasawa, Y. Kobayashi); *Chem. Abstr.* **78** (1973) 86706e.
110. Carus Chemical Company, US 4085191, 1978 (P. G. Mein, H. Adolf).
111. Academy of Sciences, Kasakh SSR, SU 874135, 1981 (A. V. Kotova, N. S. Buyanova, S. T. Deikalo, Y. N. Kolesnikov); *Chem. Abstr.* **96** (1982) 37689q.
112. Nippon Chemical Industrial Co., JP Kokai 7411664 1974 (T. Takeda, K. Aihara); *Chem. Abstr.* **80** (1974) 144813s.
113. E. T. Berezhenko, B. M. Kuninets, E. V. Martynets, L. V. Pisarev, *Khim. Tekhnol. Kiev* **4** (1981) 29-30; *Chem. Abstr.* **95** (1981) 208465z.
114. *Chem. Tech. (Leipzig)* **33** (1981) no. 4, 209.
115. Industrial Química del Nalón S.A., BE 905130, 1986 (M. O. González García).
116. Spolek Pro Chemickov a Hutni Vyrobu n.p., Usti n. L., personal communication.
117. *The United States Pharmacopeia*, XIX revision (1975) p. 394; XX revision, 4th suppl. (1983) p. 711, United States Pharmacopeial Convention Inc., Rockville, MD.
118. *Reagent Chemicals*, 7th ed., American Chemical Society, Washington, DC, 1986, pp. 533-535.
119. NSF: *Standard 60 for Drinking Water Treatment Chemicals - Health Effects*, December 1987, revised June 1988, NSF, Ann Arbor, MI.
120. DIN 19619, *Kaliumpermanganat zur Wasseraufbereitung, Technische Lieferbedingungen*, Feb. 1975.
121. K. Fieck in R. L. Sanks (ed.): *Water Treatment Plant Design for the Practicing Engineer*, Ann Arbor Science Publications, Inc., Ann Arbor, MI, 1978, 461-479.
122. Ph. C. Singer, J. H. Borchardt, J. M. Colthurst, *J. Am. Water Works Assoc.* **72** (1980) 573-578.
123. K. S. Pisarczyk, L. A. Rossi, *Sludge Odor Control and Improved Dewatering with Potassium Permanganate*, paper presented at the 55th Annual Conference of the Water Pollution Control Federation in St. Louis, 5 Oct. 1982; *J. H. Jackson, Pulp & Pap.* **58** (1984) 147-149.

124. Hiyuga Scirensheo K.K., JP-Kokai 7830163, 1978 (K. Atsuchi, F. Hagiwara, K. Fujita).
125. C. Freudenberg K.-G., Langbein-Pfanhauser Werke AG, DE-OS 3335746, 1985 (L. Feikes, D. Schröder, P. Reyer); *Chem. Abstr.* 103 (1985) 26768b.
126. K. J. Ficek, *Paint Varn. Prod.* 63 (1973) no. 5, 45.
127. Carus Chemical Company, US 2504131, 1950 (T. Jaskowiak).
128. M. M. Kushnir, *Khim. Prom. Nauk. Tekhn. Zh.* 79 (1963); *Chem. Abstr.* 59 (1963) 4813.
129. Morton Thiokol Inc., US 4601783, 1986; US 4601784, 1986 (G. Krulik).
130. Leningrad Technological Institute, SU 1353780, 1987 (N. A. Lavrov, A. F. Nikolaev, N. A. Astafeva); *Chem. Abstr.* 108 (1988) 205263h.
131. Committee on Medical and Biologic Effects of Environmental Pollutants, National Research Council, Manganese, Washington, DC, 1973.
132. FDA: *Fed. Regist.* 50 (1985) 19164-19167.
133. EPA: *Health Assessment Document for Manganese, Final Report*, EPA-600/18-83-013F, NTIS PB 84-229954, Environmental Criteria Assessment Office, Cincinnati 1984.
134. EPA: *Health Effects Assessment for Manganese (and Compounds)*, EPA/54011-861057. PB 86-134681, Office of Health and Environmental Assessment, Cincinnati 1984.
135. U.S. Department of Health and Human Services, Public Health Service, Centers for Disease Control, NIOSH: *Registry of Toxic Effects of Chemical Substances*, 13th ed., 1983-1984 cumulative supplement to the 1981-1982 ed.
136. WHO: *Task Group on Environmental Health Criteria for Manganese, Environmental Health Criteria 17: Manganese*, WHO, Geneva 1981.
137. Registry of Toxic Effects of Chemical Substances, ed. 1985/86, item 55171, U.S. Department of Health and Human Services DHHS (NIOSH), publication no. 87-114.
138. M. Tolonen: "Industrial Toxicology of Manganese", *Work, Environ. Health* 9 (1972) 53-60.
139. H. Roels et al., *Am. J. Ind. Med.* 11 (1987) 297-305.
140. H. Roels et al., *Am. J. Ind. Med.* 11 (1987) 307-327.
141. R. Schiele, *Met. Umwelt* 1984, 471-477.
142. NIOSH: *Fed. Regist.* 53 (1988) no. 109, 21000-21001.
143. EPA: *Fed. Regist.* 50 (1985) 36627-36628.
144. EPA: *Locating and Estimating Air Emission from Sources of Manganese*, EPA-450/14-85-007h, NTIS PB 86117587, Sep. 1985.
145. R. J. Bull, G. F. Craun: "Health Effects Associated with Manganese in Drinking Water", *J. Am. Water Works Assoc.* 69 (1977) 662-663.

## 48 Silicon

WERNER ZULEHNER (§§ 48.1-48.4); WALTER SIMMLER (§ 48.5); BERND NEUER, GERHARD RAU (§ 48.6); OTTO W. FLÖRKE, BRIGITTE MARTIN (§§ 48.7.1-48.7.2); LEOPOLD BENDA, SIEGFRIED PASCHEN (§ 48.7.3); HORACIO E. BERGNA, WILLIAM O. ROBERTS (§ 48.7.4); WILLIAM A. WELSH (§ 48.7.5); MANFRED ETTLINGER (§ 48.7.6); DIETER KERNER, PETER KLEINSCHMIT, JÜRGEN MEYER (§ 48.7.7); HERMANN GIES (§ 48.7.8); DIETMAR SCHIFFMANN (§ 48.7.9)

|  |      |  |      |
|--|------|--|------|
| 48.1 Introduction .....                  | 1862 | 48.7.1.4 Silica Rocks .....                  | 1911 |
| 48.2 History .....                       | 1862 | 48.7.1.5 Crystalline Silica Products .....   | 1911 |
| 48.3 Properties .....                    | 1862 | 48.7.2 Quartz Raw Materials .....            | 1917 |
| 48.4 Production .....                    | 1863 | 48.7.2.1 Physical Forms and Occurrence ..    | 1917 |
| 48.4.1 Metallurgical Silicon .....       | 1863 | 48.7.2.2 Processing .....                    | 1919 |
| 48.4.2 Semiconductor Silicon .....       | 1865 | 48.7.2.3 Uses .....                          | 1921 |
| 48.4.2.1 Purification .....              | 1865 | 48.7.3 Kieselguhr .....                      | 1925 |
| 48.4.2.2 Chemical Vapor Deposition ..... | 1866 | 48.7.3.1 Introduction .....                  | 1925 |
| 48.4.2.3 Single-Crystal Growth .....     | 1868 | 48.7.3.2 Formation, Composition, and Quality | 1925 |
| 48.4.2.4 Wafer Manufacture .....         | 1876 | Criteria .....                               | 1925 |
| 48.4.2.5 Epitaxy .....                   | 1877 | 48.7.3.3 Occurrence and Mining .....         | 1927 |
| 48.4.2.6 Characterization .....          | 1879 | 48.7.3.4 Processing .....                    | 1927 |
| 48.4.3 Solar Silicon .....               | 1879 | 48.7.3.5 Analysis .....                      | 1929 |
| 48.4.3.1 Crystalline Silicon .....       | 1880 | 48.7.3.6 Storage and Transport .....         | 1930 |
| 48.4.3.2 Amorphous Silicon .....         | 1882 | 48.7.3.7 Environmental and Health            | 1930 |
| 48.5 Compounds .....                     | 1883 | Protection .....                             | 1930 |
| 48.5.1 Hydrides .....                    | 1883 | 48.7.3.8 Uses .....                          | 1931 |
| 48.5.1.1 Monosilane .....                | 1884 | 48.7.3.9 Recycling .....                     | 1932 |
| 48.5.1.2 Disilane .....                  | 1885 | 48.7.4 Colloidal Silica .....                | 1932 |
| 48.5.1.3 Purification .....              | 1885 | 48.7.4.1 Introduction .....                  | 1932 |
| 48.5.1.4 Uses .....                      | 1885 | 48.7.4.2 Structure of Colloidal Silica       | 1934 |
| 48.5.1.5 Safety Measures .....           | 1886 | Particles .....                              | 1934 |
| 48.5.1.6 Photochemistry .....            | 1886 | 48.7.4.3 Physical and Chemical Properties .. | 1939 |
| 48.5.2 Halides .....                     | 1886 | 48.7.4.4 Stability .....                     | 1941 |
| 48.5.2.1 Trichlorosilane .....           | 1886 | 48.7.4.5 Production .....                    | 1943 |
| 48.5.2.2 Tetrachlorosilane .....         | 1889 | 48.7.4.6 Analysis and Characterization ..    | 1945 |
| 48.5.2.3 Hexachlorodisilane .....        | 1892 | 48.7.4.7 Uses .....                          | 1945 |
| 48.5.2.4 Other Chlorides .....           | 1893 | 48.7.4.8 Storage, Handling, and              | 1946 |
| 48.5.2.5 Fluorides .....                 | 1893 | Transportation .....                         | 1946 |
| 48.5.2.6 Bromides .....                  | 1893 | 48.7.4.9 Economic Aspects .....              | 1947 |
| 48.5.2.7 Iodides .....                   | 1894 | 48.7.5 Silica Gel .....                      | 1948 |
| 48.5.3 Oxides .....                      | 1895 | 48.7.5.1 Introduction .....                  | 1948 |
| 48.5.3.1 Monoxide .....                  | 1895 | 48.7.5.2 Structure, Properties, and          | 1948 |
| 48.5.3.2 Sesquioxides .....              | 1896 | Characterization .....                       | 1948 |
| 48.5.3.3 Other Silicon-Oxygen Compounds  | 1897 | 48.7.5.3 Production .....                    | 1951 |
| 48.5.4 Sulfides .....                    | 1897 | 48.7.5.4 Uses .....                          | 1952 |
| 48.5.5 Borides .....                     | 1898 | 48.7.5.5 Economic Aspects .....              | 1954 |
| 48.6 Silicides .....                     | 1899 | 48.7.5.6 Legal Aspects .....                 | 1954 |
| 48.6.1 General .....                     | 1899 | 48.7.6 Pyrogenic Silica .....                | 1954 |
| 48.6.2 Calcium Silicon .....             | 1900 | 48.7.6.1 Flame Hydrolysis .....              | 1954 |
| 48.7 Silica .....                        | 1902 | 48.7.6.2 Electric-Arc Process .....          | 1962 |
| 48.7.1 Silica Modifications and Products | 1902 | 48.7.6.3 Plasma Process .....                | 1962 |
| 48.7.1.1 Geochemistry and Crystal        | 1902 | 48.7.7 Precipitated Silicas .....            | 1962 |
| Structure .....                          | 1902 | 48.7.7.1 Introduction .....                  | 1962 |
| 48.7.1.2 Crystalline Silica Phases ..... | 1905 | 48.7.7.2 Production .....                    | 1962 |
| 48.7.1.3 Noncrystalline Silica Minerals  | 1911 | 48.7.7.3 Properties .....                    | 1963 |
|  |      | 48.7.7.4 Uses .....                          | 1965 |
|  |      | 48.7.8 Porosils .....                        | 1967 |



|  |      |  |      |
|--|------|--|------|
| 48.7.8.1 Introduction . . . . .                    | 1967 | 48.7.9.1 Experiences with Humans . . . . . | 1970 |
| 48.7.8.2 Physical and Chemical Properties. . . . . | 1967 | 48.7.9.2 Animal Experiments . . . . .      | 1971 |
| 48.7.8.3 Manufacture of Porosils. . . . .          | 1969 |  |      |
| 48.7.9 Toxicology . . . . .                        | 1970 | 48.8 References . . . . .                  | 1973 |

## 48.1 Introduction<sup>1</sup>

Silicon is a gray, metallically lustrous element with atomic number 14 and atomic mass 28.086. It is situated between carbon and germanium in the periodic table and has three natural isotopes: <sup>28</sup>Si (92.2%), <sup>29</sup>Si (4.7%), and <sup>30</sup>Si (3.1%). Corresponding to its position in the periodic table, silicon has four valence electrons, two of them in the 3s and two in the 3p levels. It crystallizes in the diamond structure like diamond, germanium, and  $\alpha$ -tin. Silicon is a nonmetallic, semiconducting element with a resistivity of ca. 400 k $\Omega$ cm at room temperature in its purest state. Its electrical resistivity decreases with increasing temperature and increasing concentration of electrically active elements such as B, Al, Ga, In, Tl, P, As, and Sb. By doping silicon with boron, for example, its room-temperature resistivity can be reduced by nine orders of magnitude to ca. 0.4 m $\Omega$ cm. Except for very thin foil, silicon is impermeable to visible light, but it is highly permeable to infrared light. The IR permeability decreases with decreasing electrical resistivity.

After oxygen (50.5%), silicon is the second most abundant element (27.5%) in the lithosphere. It does not occur in elemental form, but only in oxides and silicates.

Modern electronics is almost exclusively (> 95%) based on silicon devices, both in low-power and in high-power electronics, a situation that will continue for at least the next few decades. Because of the eminent and ever increasing importance of electronics in technology and everyday life, silicon is one of the most important technical materials, although the quantity required for this application is relatively small (ca. 10 000 t of electronic-grade silicon in 1992). This small quantity results

from the very small dimensions of electronic devices (e.g., 0.5  $\times$  4  $\times$  4 mm).

Of secondary importance are the uses of silicon for metallurgy and chemistry (silicon compounds), although they consume the major portion of the silicon produced.

## 48.2 History

The name silicon derives from the Latin word *silex* (= flint). Even in ancient times, silicon compounds were used for the production of glass. The first attempts to obtain elemental silicon from silica were made in the 1700s, but only in 1810 did BERZELIUS succeed in isolating silicon from ferrosilicon by reduction with carbon and iron at the melting point of iron. In 1823, he obtained iron-free silicon by reducing SiF<sub>4</sub> with potassium metal.

In 1854, SAINTE-CLAIRE DEVILLE obtained coarse-grained silicon by fusion electrolysis of silicon-containing NaAlCl<sub>4</sub>. Further important developments were achieved by WÖHLER (1855), WINKLER (1864), SCHEID (1899), and KÜHNE (1902). Commercial production of ferrosilicon (iron-rich silicon), which had proved to be an excellent deoxidant in steel production, began in the early 1900s as an offshoot of calcium carbide production. Ferrosilicon is produced in the same type of furnace as calcium carbide and is a by-product of calcium carbide production.

## 48.3 Properties

Some physical properties of silicon are as follows (values without references are taken from [1]):

|  |           |
|--|-----------|
| Atomic number  | 14        |
| A <sub>r</sub>   | 28.086    |
| Lattice constant<br>(= edge length of the cubic unit cell) | 0.5431 nm |
| Interatomic distance in (111)<br>direction                 | 0.2352 nm |

<sup>1</sup> For Ferrosilicon, see Section 7.3.

## Silicon

|  |  |
|--|--|
| Atomic density   | $5.00 \times 10^{22}$ atoms/cm <sup>3</sup>          |
| Density at 300 K                                       | 2.329 g/cm <sup>3</sup>                              |
| Density at melting point                               |  |
| Solid  | 2.30 g/cm <sup>3</sup>                               |
| Liquid   | 2.51   |
| Volume increase at transition<br>from liquid to solid  | + 9.1 %  |
| Specific heat (300 K)                                  | 0.713 J g <sup>-1</sup> K <sup>-1</sup>              |
| Thermal expansion (300 K)                              | $2.6 \times 10^{-6}$ K <sup>-1</sup>                 |
| Thermal conductivity (300 K)                           | 1.5 W cm <sup>-1</sup> K <sup>-1</sup>               |
| mp   | 1687 K   |
| bp   | 3504 K [2]   |
| Critical temperature                                   | 5193 K   |
| Critical pressure                                      | 145 MPa  |
| Latent heat of fusion                                  | 50.66 kJ/mol   |
| Heat of evaporation                                    | 385 kJ/mol   |
| Combustion heat, H <sub>0</sub> (Si/SiO <sub>2</sub> ) | 850 kJ/mol   |
| Bulk modulus (300 K)                                   | 97.84 Pa   |
| Vickers hardness                                       | 10.2 GPa   |
| Mohs hardness  | 7  |
| Surface tension at melting point                       | 885 mJ/m <sup>2</sup>                                |
| Band gap (300 K)                                       | 1.126 eV   |
| Electron mobility                                      | 1440 cm <sup>2</sup> V <sup>-1</sup> s <sup>-1</sup> |
| Hole mobility  | 484 cm <sup>2</sup> V <sup>-1</sup> s <sup>-1</sup>  |

As an element of group 14 of the periodic table, silicon represents the transition from the base metals of groups 1, 2, and 13 to the metalloids and nonmetals of groups 15–17. With nonmetals of higher electronegativity, silicon forms predominantly nonpolar compounds such as Si<sub>3</sub>N<sub>4</sub> or SiC, as well as more polar compounds such as SiO<sub>2</sub> and SiF<sub>4</sub> with oxidation state 4+. If Si–Si bonds are present, the mean oxidation state is lower (e.g., 3+ in Si<sub>2</sub>I<sub>6</sub>).

Silicon binds oxygen dissolved or present as compounds in metal melts to give SiO<sub>2</sub> or SiO, and it may partially evaporate in the form of the volatile SiO. With metals, silicon forms alloys, intermetallic compounds, or silicides.

Bulk silicon is very resistant to acid, including HF or HNO<sub>3</sub>, but not to a mixture of HF and HNO<sub>3</sub>. In this mixture, HF first etches away the SiO<sub>2</sub> layer from the silicon surface, then HNO<sub>3</sub> oxidizes silicon again, the new SiO<sub>2</sub> layer is removed by HF, and so on. Silicon reacts violently with even dilute alkaline solutions to generate hydrogen. Heating in an oxygen-containing atmosphere forms an SiO<sub>2</sub> layer that inhibits further oxidation. Above 520 K, silicon reacts with HCl to form SiHCl<sub>3</sub> and SiCl<sub>4</sub>, and with CH<sub>3</sub>Cl in the presence of copper to give alkylchlorosilanes. At ca. 620 K, silicon and HBr give SiBr<sub>4</sub> and SiHBr<sub>3</sub>. At

room temperature, silicon and fluorine produce SiF<sub>4</sub>.

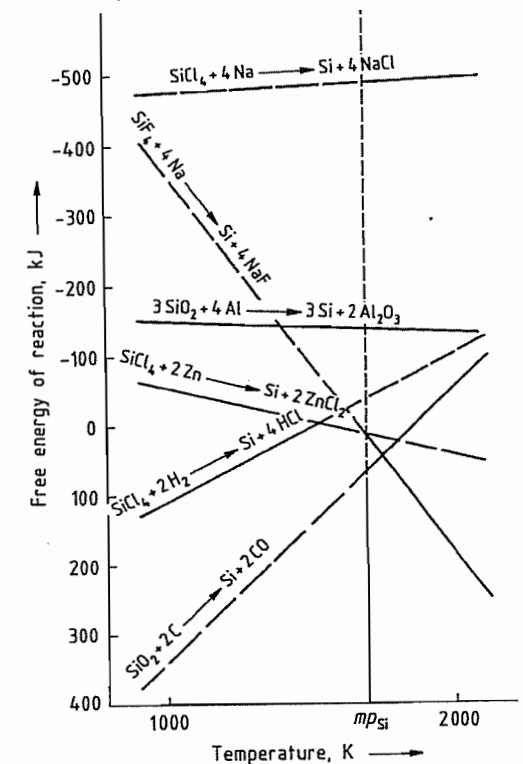
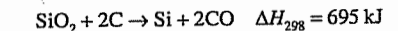

Figure 48.1: Free energy of selected reactions for production of silicon from SiO<sub>2</sub> and Silicon tetrahalides [5].

## 48.4 Production

### 48.4.1 Metallurgical Silicon

Since the turn of the century, silicon has been produced almost exclusively by carbothermal reduction of silicon dioxide:



Another way to produce silicon from SiO<sub>2</sub> is aluminothermal reduction:

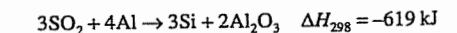

Figure 48.1 shows the free energy of reaction  $\Delta G_0$  of the two reactions for the range 900 to 2100 K. Whereas carbothermal reaction of SiO<sub>2</sub> is unattractive below 2000 K, reduction with aluminum is strongly exothermic over

the entire temperature range. In carbothermic reaction, the side reactions

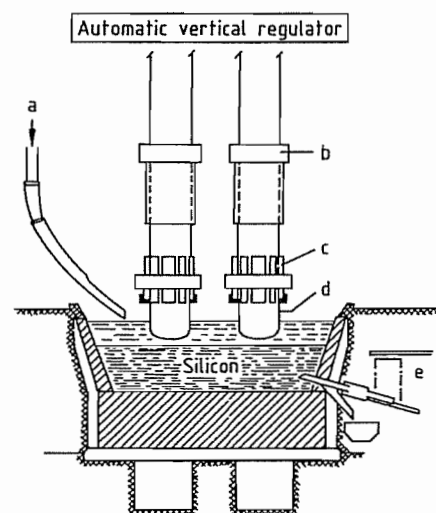
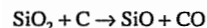
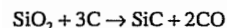

Figure 48.2: Arc furnace for silicon production [5]: a) Input of quartz and carbon; b) Electrode holder; c) Electric contact; d) Carbon electrode; e) Tapping electrode.



and



must be avoided.

For the carbothermal production of silicon and ferrosilicon, electric-arc furnaces (Figure 48.2) are used. For silicon production, graphite electrodes are used, whereas for the production of ferrosilicon, Söderberg electrodes (steel tubes filled with a mixture of coal powder, tar, and pitch) are employed. The carbothermal process yields silicon with a purity of ca. 98% (metallurgical-grade silicon, MG-Si), for which a typical analysis is 0.5% Fe; 0.4% Al; 100–400 ppm each of Ca, Cr, Mg, Mn, Ni, Ti, and V; and 20–40 ppm each of B, Cu, P, and Zr. The usual starting materials are chunks of quartzite, coke, as well as charcoal and wood chips for good ventilation of the charge. To produce 1 t of silicon, 2.9–3.1 t of quartz or quartzite, 1.2–1.4 t of coke (gas coke and petroleum coke), and 1.7–2.5 t of charcoal and wood are required. The consumption of electrode graphite is 120–140 kg/t Si, which must be added to the amount of reducing

agent, and of electrical energy is 12.5 14 MWh/t Si. The purity of the silicon produced depends primarily on the purity of these materials and secondarily on the purity of the graphite electrodes and the furnace lining.

The purity of silicon can be increased by using purer starting materials, by improving the furnace construction, and by optimizing the production process. Dow Corning [3, 4] has introduced an improved arc furnace, the so-called direct arc reactor (DAR), which yields purer silicon. With adequately pure starting and furnace materials and with optimized operation, the DAR process gives silicon with a purity of 99.99%. Residual impurities are Al, Fe (50–100 ppm each), and other metals, as well as B and P (< 10 ppm each).

Another method of producing silicon starts with silicon tetrafluoride, which is a by-product of the production of superphosphate fertilizer from phosphate rock. The ore contains  $\text{CaF}_2$ , which is converted to HF when treated with  $\text{H}_2\text{SO}_4$ ; HF then reacts with  $\text{SiO}_2$  to form  $\text{SiF}_4$ , with an estimated 75 000 t/a being recovered in the United States as fluosilicic acid,  $\text{H}_2\text{SiF}_6$ . Sodium fluoride is added to the  $\text{H}_2\text{SiF}_6$  to form sodium fluosilicate:

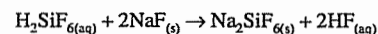

After filtration and drying,  $\text{Na}_2\text{SiF}_6$  is decomposed at 920 K:

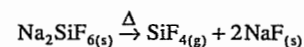

Then,  $\text{SiF}_4$  is purified by passing it over iron at 1070 K to remove air and  $\text{SO}_2$ , and by subsequent fractional distillation. Silicon tetrafluoride can be reduced readily to silicon by reaction with sodium:

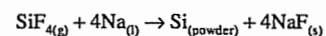

The exothermic character of this reaction provides sufficient heat to maintain the process at 770 K. To separate silicon from NaF, the Si–NaF mixture is melted to form two immiscible phases for which liquid–liquid extraction (migration of impurities from silicon to NaF) provides additional purification. This reduction process is known as the SRI (Stan-

ford Research Institute International) process [6, 7]. Because the reduction reaction yields four times as much NaF as silicon, low-cost silicon is attainable only if the by-product can be sold.

An alternative way to transform  $\text{H}_2\text{SiF}_6(\text{aq})$  into elemental silicon is used by Ethyl Corporation [8]:

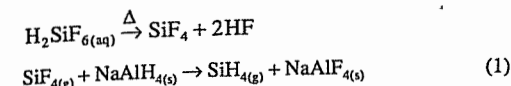

Also,  $\text{KAlH}_4$  or a mixture of  $\text{NaAlH}_4$  and  $\text{KAlH}_4$  can be used.  $\text{NaAlF}_4$  is used in aluminum production, and  $\text{SiH}_4$  is decomposed at ca. 1000 K to generate elemental silicon:



About 150 other reactions yield elemental silicon, but most of them are not used in industrial production.

Ferrosilicon production, ca.  $2 \times 10^6$  t in 1992, constitutes the major part of industrial silicon production. Ferrosilicon is used in steelmaking, mainly as a deoxidizer, but also as an alloying element (e.g., for the production of transformer sheet metal).

World production of metallurgical-grade silicon in 1991 was ca. 650 000 t, with a market price of ca. \$1.5/kg. About 60% was used as an alloying element for nonferrous metals, particularly aluminum alloys; ca. 37% for the production of silicon compounds; and ca. 3% for electronic applications (electronic devices, solar cells, sensors, micromechanics). The main producer countries for MG silicon are Norway, the United States, France, Canada, the Republic of South Africa, the CIS, Italy, Spain, and Yugoslavia.

## 48.4.2 Semiconductor Silicon

### 48.4.2.1 Purification

For applications in electronics, photovoltaics, sensors, and micromechanics, metallurgical-grade silicon must be refined to a much higher purity. Purity requirements for the fabrication of high-efficiency solar cells, for ex-

ample, are nearly as high as those for advanced semiconductor devices.

At present, the main refining steps are the adsorption and distillation of a silicon compound. For this purpose, silicon is first converted into a compound such as  $\text{SiHCl}_3$ ,  $\text{SiCl}_4$ ,  $\text{SiH}_2\text{Cl}_2$ , or  $\text{SiH}_4$ . After purification, the silicon compound is transformed back into elemental, high-purity silicon by chemical vapor deposition (CVD). Alternative refining methods [5] have not been used in industrial production up to the present.

The starting material for the production of semiconductor-grade silicon (SG-Si) is about 90% carbothermal silicon and about 10% silicon produced by the Ethyl process [8].

Carbothermal silicon, milled to a sand or powder, is fed into a fluidized-bed reactor where it is fluidized by a stream of hydrogen chloride flowing through small orifices in the bottom of the reactor (Figure 48.3). The reactor is held at ca. 650 °C and the exothermic reaction yields predominantly trichlorosilane and hydrogen,



as well as silicon tetrachloride:

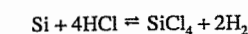

In addition to  $\text{SiHCl}_3$  and  $\text{SiCl}_4$ , other chlorosilanes and compounds of the impurities with chlorine or hydrogen are formed. After removal of silicon powder, impure trichlorosilane is condensed and stored in an intermediate tank, and subsequently purified by adsorption and distillation (Figure 48.3). Because of its favorable boiling point of 305 K, trichlorosilane can be purified effectively by fractional distillation. To improve the removal of boron and phosphorus, the two most important electrically active elements in silicon, boron(III) and phosphorus(III) chloride are transformed into less volatile compounds before distillation by use of complexing agents. In this way, the production of trichlorosilane with boron and phosphorus contents of < 1 ppba (parts per billion atomic) is possible.

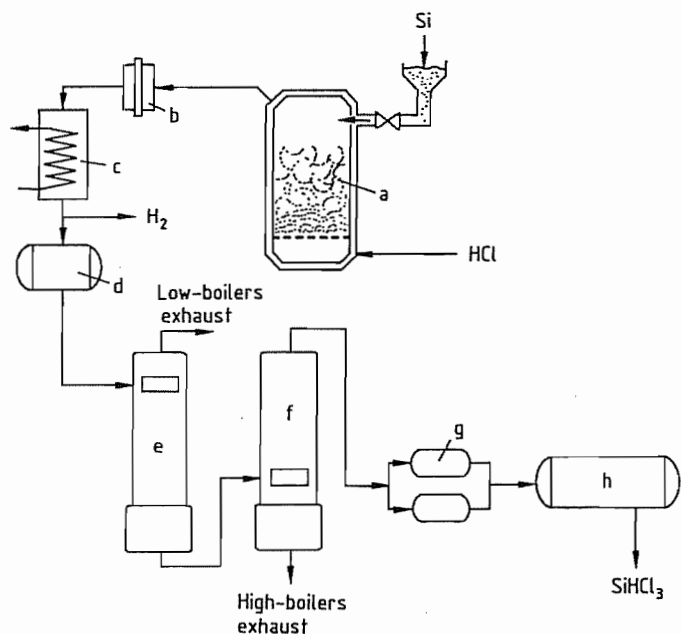

Figure 48.3: Flow chart of the preparation and refining of trichlorosilane: a) Fluidized-bed reactor; b) Dust filter; c) Condenser; d) Tanks; e) Distillation of low-boiling impurities; f) Distillation of high boilers; g) Tanks; h) Storage tanks.

From the point of view of chemical process engineering, trichlorosilane is easiest to handle and most economical. About 90% of the electronic-grade silicon is purified by distillation of trichlorosilane, and the rest by distillation of silane,  $\text{SiH}_4$ . The distillation of  $\text{SiH}_4$  is applied only after the Ethyl process (Equation 1). Silane is much more dangerous to handle than trichlorosilane.

#### 48.4.2.2 Chemical Vapor Deposition

All semiconductor-grade silicon is produced by converting silicon compounds to elemental silicon by chemical vapor deposition (CVD). For ca. 75% of worldwide CVD production, trichlorosilane is used as the silicon compound (e.g., by Wacker, Hemlock, Tokuyama Soda, Kyundo, OTC, MEMC); for ca. 25%, silane (ASiMI, Ethyl), partly produced from trichlorosilane, is used.

The method of converting trichlorosilane into high-purity silicon was first developed by Siemens & Halske in 1952 and patented in

1956 [9]. It employs the reverse of Equation (3), which is strongly endothermic and therefore requires a high reaction temperature (ca. 1400 K). This reaction also yields much tetrachlorosilane as by-product:



The by-product  $\text{SiCl}_4$  is partly converted back to trichlorosilane in the reactions

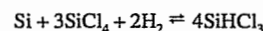
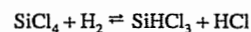

The remaining  $\text{SiCl}_4$  is used for the production of highly dispersed  $\text{SiO}_2$  (e.g., HDK from Wacker) and synthetic silica glass and glass fibers, and for silicon epitaxy in the production of electronic devices.

To avoid the deposition of silicon on unwanted and contaminating surfaces, the CVD arrangement shown schematically in Figure 48.4 is used. In a bell-jar reactor, three silicon slim-rods (ca. 8 mm in diameter, semiconductor grade, float zone pulled in a specially designed apparatus) are mounted in the form of an inverted U and are resistance heated electri-

cally to ca. 1400 K, while the bell jar is kept cold. In this way, the heat required for the reaction is available only on the surface of the silicon rods; silicon forms there exclusively and adheres to the rods. Elemental silicon not adhering to the rods is transformed back to a gaseous silicon compound at lower temperature (e.g., Equation 3) in the reactive atmosphere around the rods.

In the CVD process, the concentration of impurities is again reduced [10], in the case of boron and phosphorus by a factor of up to 1000. The trichlorosilane CVD process yields silicon with < 0.02 ppba boron and < 0.01 ppba phosphorus, so that further refining of the CVD silicon by zone melting for electronic applications is no longer necessary in most cases, in contrast to the situation at the beginning of semiconductor-grade silicon production.

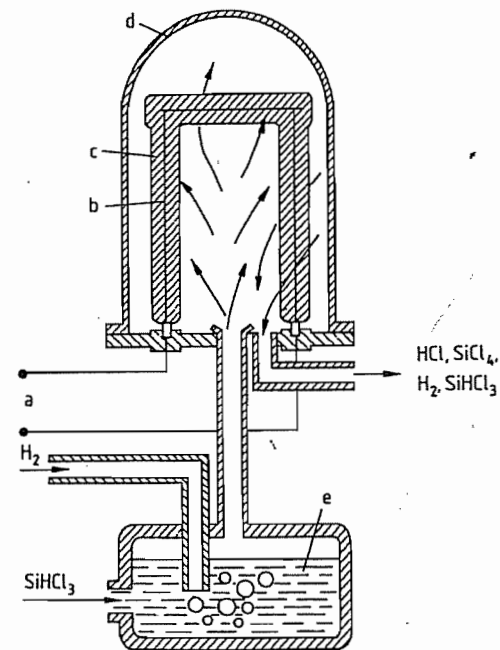

Figure 48.4: Chemical vapor deposition of silicon: a) Electrical current; b) Starting silicon slim-rod; c) CVD polycrystalline silicon rod (1400 K); d) Reactor (silica, metal); e) Saturator.

Silicon single crystals can also be grown by CVD if monocrystalline slim-rods are used. However, this process is very expensive be-

cause of the very low growth rate that must be used for single-crystal growth, and it yields low-quality single crystals. Therefore, the CVD silicon produced today is a fine-grained, polycrystalline material used as starting material for the melt growth of single crystals.

In the CVD process, much energy is lost by thermal radiation from the silicon rods. The radiant energy is absorbed largely by the cold reactor walls. Energy is therefore the primary cost factor in this process; thus endeavors are made to maximize the deposition rate. Theoretically, the highest growth rate is ca. 2 mm/h; however, growth rates used in industry are lower ca. 1 mm/h or less.

The upper limit for the deposition rate is determined by the required silicon quality, especially in the production of silicon rods for float-zone crystal growth, which requires long cylindrical silicon feed rods, free of cracks and voids, and with a smooth surface, as starting material. Too rapid a growth rate results in dendritic growth, which gives a rough surface, voids, and cracks in the material. Such a feed rod would either crack or emit silicon particles on melting during float-zone growth.

Whereas the diameter of the feed rods for float-zone growth is determined by the requirements of the crystal growth process (the diameter of the feed rods should be a little larger than that of the crystals to be grown), CVD silicon rods for the growth of crucible-pulled crystals may be of any diameter. Therefore, CVD rods for crucible pulling are always grown to the largest possible diameter for economic reasons: the CVD yield (kg/W/h) and the CVD output (kg/h) increase linearly with the radius of the rod at a constant deposition rate. However, the maximum diameter of CVD rods is ca. 25 cm, since at larger diameters, the center of the rod begins to melt and the rod system breaks down, causing damage to the reactor and contamination of the silicon. Therefore, the deposition process is stopped at a rod diameter known to exhibit no melting.

At present, CVD processes run automatically. Process parameters such as current, temperature, pressure, gas flow, and concentration

are measured continuously and are used by a computer to calculate new control parameters. Rod lengths > 2 m and rod numbers of 8–16 per reactor are usual today.

A different method of producing CVD silicon is used by ASiMI (formerly UCC), which transforms  $\text{SiHCl}_3$  into  $\text{SiH}_4$  and performs the CVD process with  $\text{SiH}_4$  at ca. 1000 K. The CVD reactor and arrangement are similar to those used for deposition with  $\text{SiHCl}_3$  (deposition on silicon rods, Figure 48.4). The transformation of trichlorosilane into silane occurs according to the following reactions:

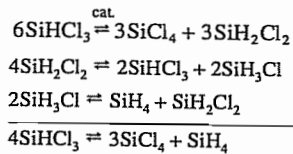

The CVD reaction is the decomposition of silane:



A very different way of transforming silane into elemental silicon is used by Ethyl, United States [11], and KRICT, Korea [12], based on a Texas Instruments patent [13].

A mixture of ca. 20 mol% silane and 80 mol% hydrogen is fed through a gas-dispersing frit into the bottom of a reactor; a fine silicon powder is let in through an opening at the top of the reactor and fluidized by the upflowing gas. The silicon powder is heated to ca. 1000 K, and silane decomposes according to Equation (4) into silicon and hydrogen on the hot silicon particles. The silicon particles grow, and the larger ones fall to the bottom of the reactor where they are removed through an opening.

In the Ethyl process, the silicon particles are heated from outside the reactor by resistance heating (Figure 48.5). This leads to problems with unwanted deposition of silicon on the hot walls of the reactor.

This problem is overcome in the newer KRICT process. Silicon particles are heated with microwaves, and the reactor wall remains cold if it is made from an appropriate material (e.g., silica).

Granular CVD silicon has major advantages over rod-shaped CVD silicon for feeding, particularly for continuous feeding of the melt with silicon during crystal growth, because the round silicon granules flow much better than the sharp-cornered grains of broken CVD silicon rods. Moreover, breaking the rods contaminates the silicon severely.

In 1992, the world production of electronic-grade CVD silicon was ca. 10 000 t with a market value of ca.  $\$500 \times 10^6$  ( $\$50/\text{kg}$ ).

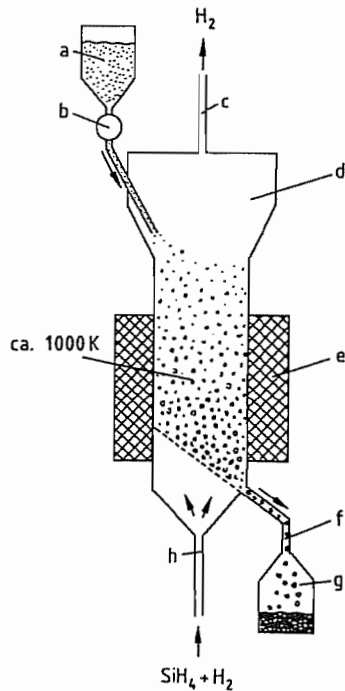

Figure 48.5: Chemical vapor deposition of granular silicon: a) Silicon powder; b) Powder-feeding device; c) Exhaust; d) Fluidized-bed reactor; e) Heating (resistance or microwave); f) Removal of coarse silicon granules; g) Container for silicon granules; h) Gas injection.

#### 48.4.2.3 Single-Crystal Growth

More than 95% of all electronic devices are made from single-crystal silicon. In addition, single-crystal silicon is used at present for ca. 40% of all photovoltaic solar cells and for all micromechanical devices. Two crystal growth methods are used in industry for the production of silicon single crystals: the Czochralski

(CZ) method, which yields about 85% of all silicon crystals, and the float-zone (FZ) method, which yields 15% of the silicon crystals. The CZ crystals are used mainly for manufacturing highly integrated low-power devices, typically for microprocessors, RAMs, DRAMs, ASICs, etc., whereas the FZ crystals are used mainly for making discrete or low-integrated high-power devices such as diodes, transistors, and thyristors.

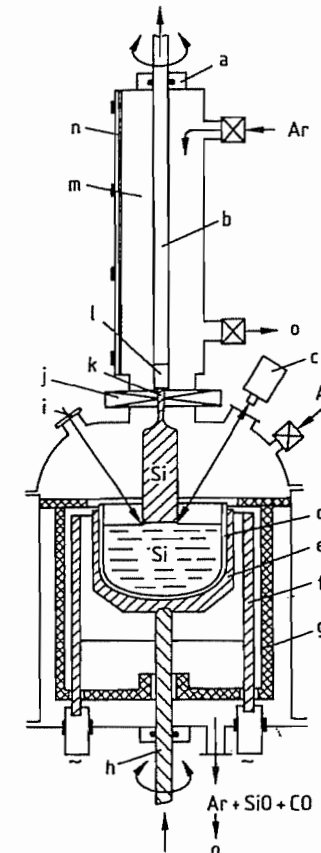

Figure 48.6: Czochralski silicon crystal puller: a) Seal; b) Seed shaft; c) Optical system; d) Silica crucible; e) Graphite crucible; f) Graphite heater; g) Thermal insulation; h) Crucible shaft; i) Viewing port; j) Separation valve; k) Seed crystal; l) Seed holder; m) Front opening chamber; n) Front opening door; o) Valve.

**Czochralski Crystal Growth.** The Czochralski method [14] uses a crucible for crystal pulling and is therefore also known as crucible pulling (see Figure 48.6; for more detailed in-

formation, see [15–17]). A silicon melt is held in a crucible and a single-crystal seed of the proper orientation is dipped into the melt and slowly withdrawn vertically. With suitable pulling speed and crystal and crucible rotation rate, a single crystal of the desired shape can be grown.

To eliminate dislocations, which always occur on immersing the seed crystal, a thin crystal neck (ca. 3–5 mm in diameter and several centimeters long) must be grown with a growth rate of several millimeters per minute. Because of the small diameter, the thermal strains in the neck are too low and the growth rate is too high for propagation of dislocations downward into the growing crystal, and the crystal neck becomes dislocation free after a few centimeters. The same procedure is used in float-zone pulling.

The dislocation-free state is stable, and large diameters can be grown despite the high cooling strains in large crystals. After neck growth, the diameter is increased to the nominal crystal diameter and then kept constant by adjusting the pulling rate and the heating power. Dislocation-free crystal growth can be completed by reducing the crystal diameter to nearly zero at the end of the crystal.

Usually, a small residual melt remains in the crucible, the amount of which depends on quality demands and economic factors. Owing to the segregation effect, the majority of the impurities remain in the melt since most of them have very low segregation coefficients (see Table 48.1).

The silicon melt reacts with all materials to some extent. Only silica can be used as crucible material, because the product of its reaction with the silicon melt, silicon monoxide ( $\text{SiO}$ ), evaporates readily from the melt. Thus supersaturation of the melt with oxygen or  $\text{SiO}$  is prevented. Supersaturation of oxygen in the melt would cause supersaturation of oxygen in the crystal, oxygen precipitation, and the formation of dislocations in the crystal near the freezing interface. The growth of a dislocation-free crystal would be impossible. All other crucible materials either contaminate the silicon crystal with impurities (e.g.,  $\text{Al}_2\text{O}_3$

or  $ZrO_2$ ) or cause dislocated crystal growth by supersaturation (e.g., SiC and  $Si_3N_4$ ).

Both to promote the evaporation and removal of SiO and to prevent the backflow of CO and other reaction and evaporation products, the furnace is purged with a strong argon stream and the pressure is kept low (generally 10–100 mbar). Table 48.2 gives an overview of the basic data for current industrial silicon crystal growth.

About 1.5 g of silica is dissolved per 1000 g of CZ-Si crystal during growth, but < 1% of the oxygen in the dissolved silica is found in the crystal. This indicates that the evaporation rate of SiO is very high and the oxygen content of the melt is exchanged every 10 min. Accordingly, oxygen transport from the crucible to the crystal and thus the oxygen content of the crystal can be manipulated over a wide range by influencing convective flows in the melt and the evaporation of SiO at the melt surface.

**Table 48.1:** Equilibrium distribution coefficients  $k_0$  and typical concentrations of impurities in CVD-Si and CZ-Si.

| Element | $k_0$                  | Impurity concentration, ppba |                        |
|---------|------------------------|------------------------------|------------------------|
|         |                        | CVD-Si                       | CZ-Si                  |
| C       | 0.07                   | ≤ 200                        | ≤ 200                  |
| N       | $7 \times 10^{-4}$     | ≤ 4 <sup>a</sup>             | < 4 <sup>a</sup>       |
| O       | ca. 1                  | ≤ 100                        | ca. 15 000             |
| A       | 0.8                    | ≤ 0.02                       | ca. 0.2                |
| Al      | $2.8 \times 10^{-3}$   | ≤ 0.01                       | ≤ 0.4                  |
| Ga      | $8 \times 10^{-3}$     | < 0.002 <sup>a</sup>         | < 0.002 <sup>a</sup>   |
| In      | $4 \times 10^{-4}$     | < 0.002 <sup>a</sup>         | < 0.002 <sup>a</sup>   |
| P       | 0.35                   | ≤ 0.01                       | ca. 0.1                |
| As      | 0.30                   | ca. 0.01                     | ≤ 0.01                 |
| Sb      | 0.023                  | ca. 0.0008                   | ca. 0.01               |
| Li      | 0.01                   | < 0.3 <sup>a</sup>           | ≤ 0.1                  |
| Na      | ca. $1 \times 10^{-3}$ | < 0.3 <sup>a</sup>           | ≤ 0.1                  |
| K       |                        | < 0.2 <sup>a</sup>           | < 0.1 <sup>a</sup>     |
| Ti      | $2.0 \times 10^{-6}$   | < 0.5 <sup>a</sup>           | < 0.5 <sup>a</sup>     |
| Cr      | $1.1 \times 10^{-5}$   | < 0.02 <sup>a</sup>          | < 0.004 <sup>a</sup>   |
| Fe      | $6.4 \times 10^{-6}$   | < 0.5 <sup>a</sup>           | ≤ 0.01                 |
| Ni      | ca. $3 \times 10^{-5}$ | ca. 0.4                      | ≤ 0.01                 |
| Co      | $1.0 \times 10^{-5}$   | ca. 0.002                    | < 0.001 <sup>a</sup>   |
| Cu      | $8 \times 10^{-4}$     | ca. 0.05                     | ≤ 0.01                 |
| Ag      | ca. $1 \times 10^{-6}$ | 0.01                         | < 0.0008 <sup>a</sup>  |
| Au      | $2.5 \times 10^{-5}$   | 0.00001                      | < 0.00001 <sup>a</sup> |
| Zn      | ca. $1 \times 10^{-5}$ | ca. 0.1                      | < 0.05 <sup>a</sup>    |
| Zr      | < $1.5 \times 10^{-7}$ | < 0.5 <sup>a</sup>           | < 0.5 <sup>a</sup>     |

<sup>a</sup>Concentration below the detection limit listed here.

**Table 48.2:** Data for industrial silicon single-crystal growth.

| Property               | Maximum value <sup>a</sup> | Industrial standard production, 1992    |   |
|------------------------|----------------------------|---|---|
|                        |                            | CZ crystals                             | FZ crystals                               |
| Diameter, mm           | ≥ 300                      | ≤ 200                                   | ≤ 150                                     |
| Length, mm             | ≥ 2500                     | ≤ 2000                                  | ≤ 1800                                    |
| Weight, kg             | ≥ 100                      | ≤ 100                                   | ≤ 50                                      |
| Orientation            | any                        | {100}, {111}, {110}, {115}              | {111}, {100}, {110}, {115}                |
| [B], cm <sup>-3b</sup> | ≤ $3 \times 10^{20}$       | $1 \times 10^{14}$ – $1 \times 10^{20}$ | $5 \times 10^{11}$ – $1 \times 10^{17}$   |
| [P], cm <sup>-3</sup>  | ≤ $3 \times 10^{20}$       | $1 \times 10^{14}$ – $1 \times 10^{18}$ | $1 \times 10^{12}$ – $5 \times 10^{18}$   |
| [As], cm <sup>-3</sup> | ≤ $3 \times 10^{20}$       | $5 \times 10^{18}$ – $8 \times 10^{19}$ |   |
| [Sb], cm <sup>-3</sup> | ≤ $3 \times 10^{19}$       | $2 \times 10^{17}$ – $1 \times 10^{19}$ |   |
| [Al], cm <sup>-3</sup> | ≤ $3 \times 10^{17}$       |   |   |
| [Ga], cm <sup>-3</sup> | ≤ $3 \times 10^{18}$       |   |   |
| [In], cm <sup>-3</sup> | ≤ $3 \times 10^{17}$       |   |   |
| [C], cm <sup>-3</sup>  | ≤ $3 \times 10^{18}$       | $1 \times 10^{15}$ – $3 \times 10^{16}$ | $1 \times 10^{15}$ – $3 \times 10^{16}$   |
| [N], cm <sup>-3</sup>  | ≤ $3 \times 10^{15}$       | < $1 \times 10^{14}$                    | < $1 \times 10^{14}$ – $1 \times 10^{15}$ |
| [O], cm <sup>-3</sup>  | ≤ $3 \times 10^{18}$       | $1 \times 10^{17}$ – $1 \times 10^{18}$ | $1 \times 10^{15}$ – $2 \times 10^{16}$   |
| Crucible material      |                            | silica                                  | no crucible                               |
| Crucible diameter, mm  |                            | ≤ 600                                   |   |
| Rotation rate, rpm     |                            | ≤ 50 crystal, ≤ 30 crucible             | ≤ 50 crystal, ≤ 2 feed rod                |
| Growth rate, mm/min    |                            | ≤ 2.5                                   | ≤ 4.5                                     |
| Pressure, mbar         |                            | 5–1000                                  | $5 \times 10^{-4}$ –5000                  |
| Argon flow, L/h        |                            | 400–5000                                |   |

<sup>a</sup>The maximum concentration for dislocation-free growth is generally lower than the maximum solubility in silicon (at ca. 1550 K) due to the effect of retrograde solubility for most of the elements (for most elements, solubility increases up to ca. 1550 K, then decreases continually up to the melting point of 1687 K). The maximum growth and rotation rates decrease with increasing crystal and crucible diameters.

<sup>b</sup>Concentration in number of impurity atoms per cm<sup>3</sup> of silicon; 1 cm<sup>3</sup> Si contains  $5.00 \times 10^{22}$  atoms.

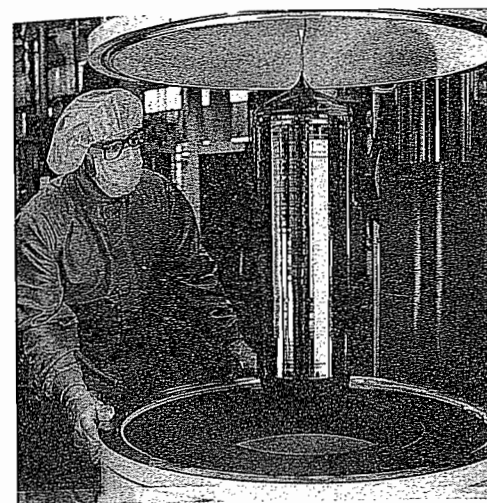

**Figure 48.7:** Removal of a large CZ silicon crystal (diameter 204 mm, weight 50 kg) that is still hanging from the seed crystal.

Impurities in the dissolved silica are absorbed by the silicon melt. However, only a small portion of impurities are incorporated into the crystal owing to the segregation effect, which is very strong for most elements (see Table 48.1). For example, from 100 000 iron atoms in the melt, only one atom is incorporated into the crystal. As a result of this strong segregation, the impurity content of the CZ-Si crystal is lower than that of the starting material for most elements.

Figure 48.6 shows the basic arrangement of a CZ-Si crystal puller, and Figure 48.7 shows a photograph of such a crystal puller during removal of a grown crystal. The best and most economical heating method is resistance heating with a graphite heating element. The soft silica crucible must be supported by a graphite crucible. The diameter of the crystal is monitored by an optical system (e.g., a CCD camera) and, in most cases, the melt and furnace temperatures are measured by pyrometers. The crystal and the crucible can be moved and rotated very precisely. A valve between the front-opening chamber and the furnace allows the removal of the crystal while the furnace is hot and refilling of the hot crucible (containing residual melt) with polycrystalline silicon and dopant. The growth control of modern

crystal pullers allows completely automatic crystal growth. However, with monitoring and correction by an operator, the yield of the crystal grower can be improved. In 1992, the standard diameters of commercial CZ-Si crystals ranged from 50 to 200 mm, averaging 150 mm, and CZ-Si crystals 300 mm in diameter are being developed.

**Float-Zone Crystal Growth.** Figure 48.8 shows the basic arrangement for large diameter float-zone silicon crystal growth in a modern FZ puller. The FZ-Si method differs from the CZ-Si method mainly in the absence of a crucible and in the small melt volume. The absence of a crucible results in a very low oxygen content and in lower concentrations of impurities compared to CZ-Si crystals. The small melt volume leads to an axially constant boron or phosphorus concentration in contrast to CZ-Si (see Figure 48.9). Boron and phosphorus are the only dopants used in industrial FZ-Si production.

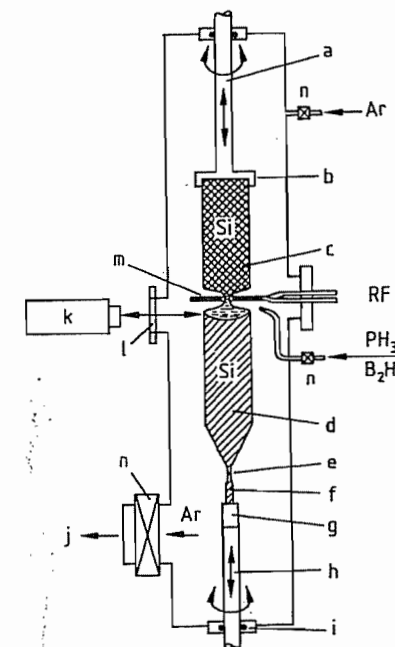

**Figure 48.8:** Float-zone silicon crystal puller: a) Feed rod shaft; b) Feed rod holder; c) Feed rod, polycrystalline; d) Single crystal; e) Neck; f) Seed; g) Seed holder; h) Seed shaft; i) Seal; j) To the vacuum pump; k) Camera; l) Viewing port; m) RF heating coil; n) Valve.

The starting material for the growth of an FZ-Si single crystal is a polycrystalline silicon feed rod clamped to a movable shaft. The feed rod can be unmelted CVD silicon or FZ-premelted silicon (CVD rods that have been float zone grown to give cylindrical, bubble- and crack-free polycrystalline rods). An induction coil melts the feed rod at the bottom, generating a large melt drop. A slim seed crystal is moved through the narrow opening in the center of the induction coil and brought into contact with the melt drop. Upon movement of the seed crystal downward the melt crystallizes on it and the seed crystal grows.

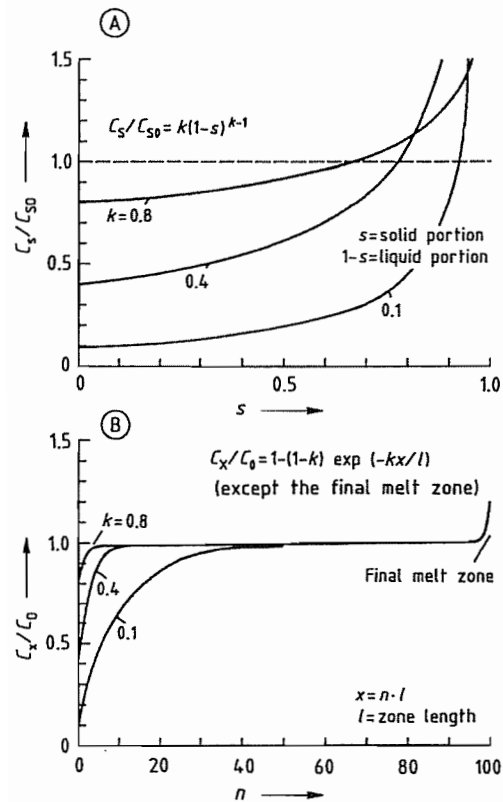

Figure 48.9: Relative axial concentration variation  $C/C_0$  in silicon crystals produced from starting material (melt or feed rod) in which the impurities are distributed homogeneously. A) CZ crystals (normal freezing); B) FZ crystals (final melt zone freezes according to normal freezing); in this example, total length of feed rod is 100l, and a constant cylindrical shape and diameter is assumed for the system feed rod-FZ melt-FZ crystal.  $k$  = Distribution coefficient.

As in CZ-Si pulling, a dislocation-free state must be generated by growing a neck prior to growth of the large-diameter crystal. After the crystal diameter is increased, melt and crystal are heated from above by the induction coil, not laterally as in the case of small crystal diameters. The melt lies on top of the crystal and is held together mainly by its surface tension and partly by electromagnetic forces. It is connected to the feed rod by a slim melt neck through which the melt flows from the feed rod to the crystal. At the end of the crystal growth process, the FZ melt freezes on top of the crystal and generates dislocations. The dislocations multiply and propagate into the crystal over a distance of about one-half the crystal diameter.

The height of the melt at the edge of the crystal is only several millimeters and does not depend on crystal diameter. Therefore, the growth of large crystal diameters is not limited by heating problems, as was assumed earlier. The FZ-Si crystals can be grown to similar dimensions as CZ-Si crystals. The main problem in the growth of large-diameter FZ-Si crystals is the high thermal stress. The temperature gradients are larger in growing FZ-Si crystals than in growing CZ-Si crystals of the same diameter because FZ-Si rods cool faster. The CZ-Si crystals are reheated by thermal radiation from the melt, the crucible, and the heater. For the growth of large diameters, cooling of the FZ-Si crystals must be reduced.

Growing large-diameter crystals requires large amounts of energy and thus high RF voltages. To prevent sparkover at the induction coils, FZ-Si growth is carried out at higher gas pressures ( $> 1$  bar). In contrast to CZ-Si growth, no argon flow takes place during FZ-Si growth; the FZ pulling chamber is first evacuated to high vacuum and then filled with argon to a certain pressure. The doping of silicon is currently realized during FZ crystal growth by the controlled addition of a doping gas ( $B_2H_6$  or  $PH_3$ ) to the argon during growth.

The monitoring and control of crystal diameter and the degree of automation of FZ-Si growth are similar to those of CZ-Si growth. Standard commercial production in 1992 (see

Table 48.2) had crystal diameters up to 150 mm (usually ca. 100 mm). Larger diameters could be developed if they were in industrial demand.

Float-zone crystals can be pulled with higher growth rates than CZ crystals, because the solidification energy of FZ crystals is removed more quickly. With FZ growth the entire environment of the cooling crystal is cold (ca. 300 K, see Figure 48.8), whereas the environment of the CZ crystal is very hot in places (melt, crucible, and furnace near 1700 K), and the growing CZ crystal receives much energy from thermal radiation.

The maximum growth rate depends strongly on the crystal diameter in both FZ and CZ growth. With increasing diameter the ratio between the heat-emitting surface (predominantly the parts of the surface hotter than 1200 K) and the heat-absorbing and generating growth interface becomes smaller, and additionally, the diffusion length of the heat increases owing to increasing distance between the crystal axis and the crystal surface. The maximum growth rate decreases from about 10 mm/min at 5-mm crystal diameter to about 1 mm/min at 150-mm crystal diameter for CZ-Si growth; the corresponding values for FZ-Si growth are 12 mm/min and 2 mm/min. In industrial production, the growth rates are lower than the maximum growth rates for reasons of yield and quality.

**Segregation of Impurities.** The axial variation of impurity concentration in CZ- and FZ-Si crystals due to segregation is shown in Figure 48.9. The segregation of impurities, in particular of dopants, has important qualitative and economical effects. Silicon device manufacturers demand silicon materials with tight resistivity tolerances, but CZ-Si crystal rods meet these tolerances only in small sections of their length.

In this respect, FZ-Si growth has major economic advantages. The resistivity of a boron- or phosphorus-doped FZ-Si crystal is nearly constant over its entire length. Strong variations occur only in the seed cone and in the finally freezing melt because of the small

FZ melt volume. The height and depth of the melt are only a few centimeters (near the crystal axis) and depend on the crystal diameter and the curvature of the concave solid-liquid interface. The melt volume in FZ growth is much smaller than in CZ growth and remains nearly constant during growth of the cylindrical crystal.

In CZ growth the silicon charge is melted completely at the beginning. The melt volume decreases and the dopant concentration increases continuously during crystal growth. This is valid for nonvolatile or moderately volatile dopants such as B, P, Al, and Ga. In the case of volatile dopants such as As, Sb, or In, the enrichment of the melt with dopant can be compensated or overcompensated by evaporation of the dopant. In FZ growth the enrichment of boron or phosphorus is continuously compensated by the supply of unenriched silicon.

Many attempts and developments have been made to eliminate the axial resistivity decrease during CZ-Si growth. A partial solution of this problem is to consume only a part (e.g., one-half) of the melt and then to refill the crucible by adding polycrystalline silicon chips or by immersion and melting of a polycrystalline silicon rod.

Conditions similar to those during FZ growth can be realized with small CZ melts that are fed quasi-continuously with silicon and dopant (Figure 48.10). The crucible is held in a fixed position and filled with melt to a certain level. A silica baffle is suspended from the cover of the furnace and dips several centimeters into the melt. The baffle has openings above the melt level to allow purging with argon. Additionally, a conical shield covers a large part of the melt surface to prevent the backflow and condensation of  $SiO$  on the feeding tube and baffle and to reduce heat losses by radiation. The silica feeding tube reaches to a short distance above the melt. Silicon granules and dopants are fed continuously through this tube at the same rate melt is removed by the growing crystal.

The problem with this technique is that fusion energy for the granules must be supplied

during crystal growth, resulting in higher temperature of the crucible walls and problems with corrosion of the silica, with oxygen content, and with dislocation-free growth. Additional problems result from silicon crystallites that "swim" underneath the baffle from outside to the growing crystal where they generate dislocations.

The fusion energy for the silicon need not be supplied to the melt from which the crystal is grown if the melt is fed with molten silicon.

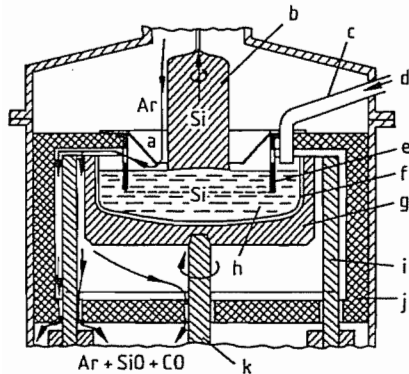

**Figure 48.10:** Quasi-continuous feeding of a CZ melt with silicon granules: a) Radiation shield, graphite; b) Crystal; c) Feeding tube, silica; d) Silicon granules; e) Baffle, silica; f) Crucible, silica; g) Susceptor, graphite; h) Melt; i) Heater, graphite; j) Thermal insulation, carbon; k) Crucible shaft, graphite.

**Melt Flows.** Constant-volume melts have the advantage that their convective flows are constant over time. On a macroscopic scale they give a constant oxygen content and a constant radial impurity distribution. Small melts have the advantage of more controllable convective flows because of their weaker thermal convection. The thermal convection in the CZ-Si melt depends on the Grashof number  $Gr$ :

$$Gr = \frac{g\alpha dTh^3}{\nu^2}$$

where  $g$  is the acceleration due to gravity,  $\alpha$  is the volume thermal expansion coefficient,  $dT$  is the temperature difference in the melt,  $h$  is the height of the melt, and  $\nu$  is the kinematic viscosity.

Owing to the dependence on  $h^3$  and  $dT$  (the temperature differences in large melts are greater than in small melts), the convective

flows in large CZ-Si melts become very turbulent, unsteady, and nearly uncontrollable. The unsteady flows result in large temperature fluctuations at the solid-liquid interface and in large fluctuations in oxygen transport to the crystal.

Figure 48.11 shows schematically the various convective flows in a CZ-Si melt. In the classical "open" growth furnace, thermal convection is strongest. A thermocapillary convection—also called Marangoni convection—always occurs below the melt surface at the edge of the crystal and at the crucible wall. It is driven by the differences in surface tension due to differences in the melt temperature. The effects of thermocapillary convection are not well understood.

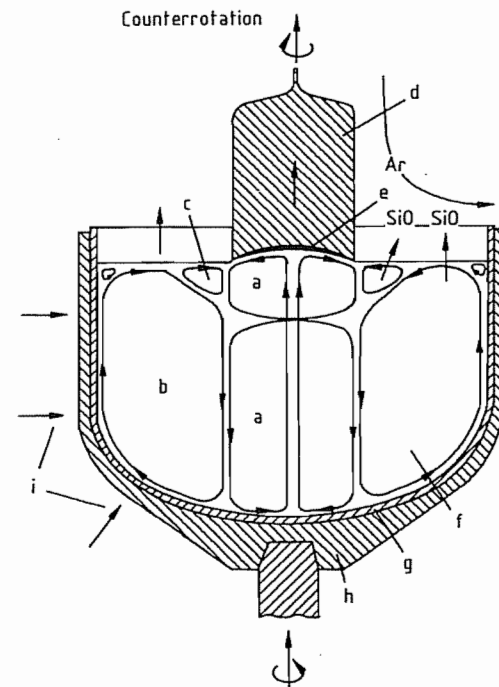

**Figure 48.11:** Schematic of the convective flows in a CZ silicon melt; flows are both temporally and locally inhomogeneous, creating temperature and concentration fluctuations. a) Mechanically forced convection; b) Thermal convection; c) Thermocapillary (Marangoni) convection; d) Crystal; e) Diffusion layer; f) Melt; g) Crucible; h) Susceptor; i) Heat flow direction.

Mechanically forced convection is generated by rotation of the crystal and crucible.

Crystal rotation must be used for two reasons. First, without rotation, the crystal would grow with a noncylindrical shape and dislocations would be generated; second, crystal rotation reduces the strong impurity enrichment toward the center of the crystal caused by thermocapillary convection and segregation.

The incorporation of impurities depends strongly on the thickness of the diffusion layer in the melt at the solid-liquid interface: the thicker the diffusion layer, the higher the incorporation of impurities into the crystal. The thickness of the diffusion layer is strongly influenced by melt flows.

**Impurity Striations.** Temperature fluctuations at the solid-liquid interface lead to unsteady growth and backmelting. These result in microscopic impurity variations in the crystal, also called impurity striations. Unsteady growth can be reduced by using a high crystal rotational velocity because, first, mechanically forced convection decreases the influence of unsteady thermal convection at the growth interface, and second, when the crystal is moved quickly over the temperature irregularities, temperature variations in the crystal are decreased owing to its thermal response time.

In general, the oxygen distribution does not correspond to the distribution of other elements; this is true on a microscopic scale as well. The effective distribution coefficient of oxygen is nearly unity and depends only slightly on the growth rate. However, the incorporation of oxygen into the growing crystal depends strongly on the pattern of convective flows in the melt. Therefore, unsteady melt flows result in an unsteady supply of oxygen and in oxygen striations in the crystal.

**Modifying Melt Flows.** Melt flows in a CZ-Si melt can be modified in several ways. In most cases, this is achieved by altering growth parameters such as crystal rotation rate, crucible rotation rate, melt dimensions, furnace dimensions, furnace construction, and so on.

A more expensive way to influence the flows in a silicon melt is by the application of magnetic fields, which interact with the free

electrons of the silicon melt and retard melt flows.

The easiest way to produce a magnetic field in a CZ-Si melt is to wind a magnetic coil around the furnace vessel and generate a vertical magnetic field in the melt. However, purely vertical fields were shown to result in poor radial impurity distributions. Better results were obtained with transverse magnetic fields, which damp the melt particularly in the vertical direction. This gives a more homogeneous radial impurity distribution of both oxygen and dopant and a low oxygen content. However, the isotherms in the melt are elliptically distorted, which causes backmelting at each revolution of the crystal and rotational striations of oxygen and dopants. Transverse magnetic fields up to 4000 G with diameters up to 100 cm are applied at present.

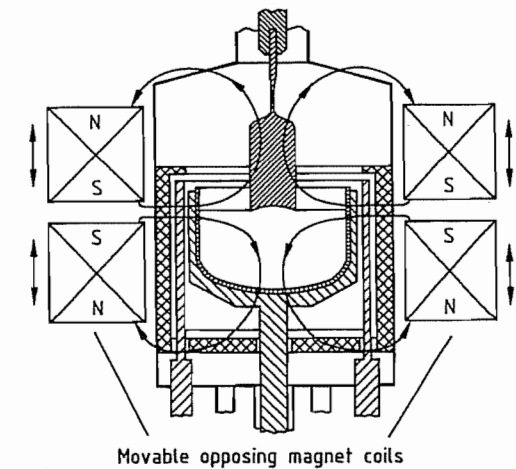
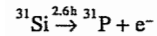
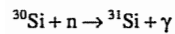

**Figure 48.12:** Growth of CZ silicon with two opposing vertical (also called cusp or configured) magnetic fields.

The third and newest method is the use of two opposing magnetic fields (see Figure 48.12); this is probably the best method of the three, but it is not yet fully developed. Two magnetic coils surround the furnace vessel and generate opposing vertical magnetic fields. The coils can be moved vertically to adjust the field to the requirements of the melt; this can also be done during crystal growth. The coils and the field strength are arranged in such a way that a strong field is present near the cru-

cible wall and a weak or zero field in the melt below the crystal. Thereby, melt flows are damped near the crucible wall and the transport of oxygen from the crucible to the crystal is reduced, but they are not damped below the crystal, where mechanically forced convection may result in a homogeneous radial impurity distribution. Good radial oxygen and dopant distributions and low oxygen contents are possible with this method.

**Neutron Transmutation Doping.** In the case of phosphorus doping, the problem of macro- and microscopical resistivity variation in silicon crystals can be overcome by neutron transmutation doping (NTD). The isotope  $^{30}\text{Si}$ , which is present in natural silicon at 3.1 atom %, can be transformed to  $^{31}\text{P}$  by absorption of a thermal neutron and emission of an electron:



In the nuclear reaction, the  $^{31}\text{Si}/^{31}\text{P}$  atoms are displaced from their lattice sites and travel a short distance through the lattice, causing lattice defects. Annealing the crystal at ca. 1100 K restores the silicon lattice, and the  $^{31}\text{P}$  atoms return to lattice sites.

The transformation takes place very homogeneously in silicon, because most of the neutrons pass through the silicon crystal without being captured, and each  $^{30}\text{Si}$  atom in the crystal has nearly the same probability of capturing a neutron as of being transformed into phosphorus. Consequently, the  $^{31}\text{P}$  atoms generated by transmutation are distributed very homogeneously in the crystal.

#### 48.4.2.4 Wafer Manufacture

After they are grown, silicon crystals are not perfectly cylindrical and do not have the precise nominal diameter despite highly automated and sophisticated crystal pulling. There are always lines of small nodes (at  $\langle 100 \rangle$  crystals) or facets (at  $\langle 111 \rangle$  crystals) on the crystal surface parallel to the crystal axis and small variations in crystal diameter. Therefore, the

crystals are grown slightly larger in diameter and then ground precisely to cylinders of the stated diameter. To allow crystal-oriented positioning of the wafers in subsequent process steps, the wafers must have flats or notches at special crystallographic sites. For this purpose, planes or notches with defined crystal orientations (e.g.,  $\langle 100 \rangle$ ,  $\langle 110 \rangle$ ,  $\langle 112 \rangle$ ) are ground into the cylinders. After grinding, the ingots are polish-etched to remove grinding damage and to reduce wafer breakage on slicing.

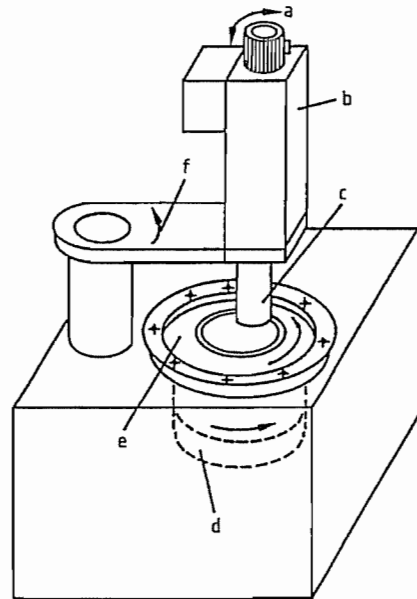

Figure 48.13: Inner-diameter (ID) sawing machine for slicing silicon: a) Crystal tilting; b) Crystal support and vertical feeding; c) Crystal; d) Saw-blade drive unit; e) ID saw blade; f) Horizontal crystal feeding.

Depending on the application of the wafers, the ingot is cut perpendicular to the crystal axis or with a well-defined misorientation of several degrees. These off-axis wafers, after polishing, are normally used as substrates for epitaxial processes. Slicing is performed with inner-diameter saws (see Figure 48.13), the saw blade of which is a 0.1-mm-thick high-grade steel foil clamped under high tension between two steel rings. The steel foil has a large circular opening in its center, the edge of which is covered with small diamonds at-

tached to the foil by a galvanic nickel layer. During sawing, the steel foil rotates at ca. 2000 rpm and consumes 0.3 mm of the ingot length (0.3-mm cutting loss). This method generates the flattest and most parallel cuts, and allows the cutting of silicon wafers down to ca. 150- $\mu\text{m}$  thickness with little wafer breakage. For the manufacture of electronic devices, wafers with thicknesses between 150 and 1000  $\mu\text{m}$  are cut.

After cutting, the wafers are edge-rounded in special machines, which enable the grinding of different round forms. Edge rounding substantially reduces chipping of the edges in subsequent process steps, imparts a higher mechanical strength to the wafers, and prevents the so-called epi-crown (irregular outgrowth of silicon at the wafer edge) in epitaxial deposition processes and the piling up of photoresist at the edges.

Especially for the mask printing techniques of modern VLSI (very large scale integrated) device manufacturing, the flatness and parallelism of the wafers must be improved by a lapping step. The silicon wafers are lapped between two large counterrotating steel disks, whereby the wafers are held and led by a lapping carrier. A suspension of an abrasive (a powder of silicon carbide, aluminum oxide, or a mixture of oxides with tightly specified grain size) is added to the process. After lapping, the wafers are etched to remove mechanical damage and then polished.

Figure 48.14 shows a schematic of a polishing machine for silicon wafers. Nowadays, polishing methods basically involve the combined action of chemical and mechanical forces. The polished wafer surface must be free of any residual damage, because such damage may cause stacking faults during subsequent oxidation treatments. Another very stringent demand on surface quality stems from modern photolithographic processing techniques. The polished surface must lie within the depth-of-focus range of the optical systems used to project a masking pattern on the photoresist covering the surface of the wafer.

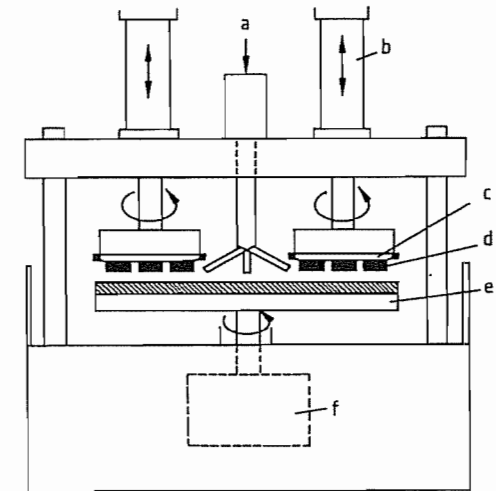

Figure 48.14: Polishing machine for silicon wafers: a) Polishing slurry feeding; b) Polishing pressure control; c) Wafer carrier; d) Wafers; e) Polishing plate; f) Drive unit.

With current technology, 200-mm-diameter wafers with both total flatness and total thickness variation of  $< 1 \mu\text{m}$  are obtained. After polishing, a careful multistep cleaning process follows that yields a wafer free of particles ( $> 0.2 \mu\text{m}$ ) and residues.

#### 48.4.2.5 Epitaxy

In epitaxy a crystallographically oriented film is grown as an extension onto an oriented crystal substrate. The growth of an epitaxial film or layer may be realized either by chemical vapor deposition, by physical vapor deposition (e.g., molecular beam epitaxy, MBE), or by liquid-phase epitaxy (LPE). In industrial silicon epitaxy, chemical vapor deposition is employed [18, 19]. With this method, homoepitaxial silicon layers with thicknesses of 0.5–120  $\mu\text{m}$  are deposited on perfectly polished single-crystal silicon wafers or substrates. The epitaxial or epi layers extend the crystal structure of the substrate exactly and differ only in resistivity and dopant. For device manufacturing, resistivities of ca. 0.03–50  $\Omega\text{cm}$  are generated in the layers by doping, mainly with boron, phosphorus, and arsenic.

Epitaxy is performed both on the whole wafer surface (after polishing and prior to device



manufacturing) and on small areas of structured wafers (during device manufacturing). In most cases, only one layer is deposited, but in some cases two or three additional layers of different thickness, resistivity, and dopant are deposited. The reasons for using epitaxial layers in device technology are numerous and various [18, 19]. The use of vapor-phase epitaxy in the semiconductor industry began in the early 1960s.

Epitaxial deposition of silicon is in principle the same process as the chemical vapor deposition used for the production of high-purity polycrystalline silicon. It is carried out at about the same temperature (usually ca. 1400 K) but with a lower growth rate and more precise control. Epitaxial deposition is possible down to ca. 1100 K. At lower temperature the silicon layer becomes polycrystalline or amorphous. The chlorosilanes  $\text{SiCl}_4$ ,  $\text{SiHCl}_3$ , and  $\text{SiH}_2\text{Cl}_2$  are used most frequently as silicon sources, with hydrogen as a reducing gas. The overall simplified reactions are

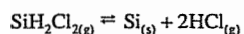
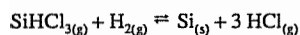
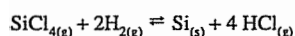

By using trichlorosilane,  $\text{SiHCl}_3$ , and hydrogen at 1400 K, an epitaxial silicon layer grows at about 5  $\mu\text{m}/\text{min}$ . Table 48.3 gives epitaxial growth rates for various silanes and temperatures [19].

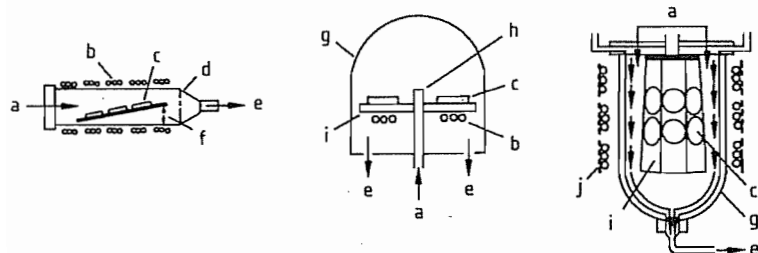
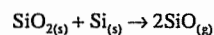

Figure 48.15: Three types of epitaxy reactors for silicon wafers: a) Gas inlet; b) Induction coil; c) Silicon wafers; d) Silica tube; e) Exhaust; f) Tilt angle; g) Silica belt; h) Inlet nozzle; i) Wafer susceptor; j) Radiant heaters.

Table 48.3: Chemical vapor epitaxial growth of silicon films.

| Silane                    | Temperature range, K | Attainable growth rate, $\mu\text{m}/\text{min}$ |
|---------------------------|----------------------|--|
| $\text{SiCl}_4$           | 1420–1530            | 0.4–15.0   |
| $\text{SiHCl}_3$          | 1370–1480            | 0.4–2.0  |
| $\text{SiH}_2\text{Cl}_2$ | 1320–1430            | 0.4–3.0  |
| $\text{SiH}_4$            | 1220–1330            | 0.2–0.3  |

Prior to deposition, the native oxide on the silicon wafer is removed by baking in hydrogen:



After that, a brief hydrogen chloride etch is generally applied to remove impurities from the wafer surface. During epitaxy, the wafer is held by a susceptor made of high-purity graphite coated with a layer of silicon carbide. The graphite susceptor is also hot during deposition and therefore is also covered with a silicon layer after epitaxy. This unwanted silicon layer is removed by etching with hydrogen chloride. In this way, deposition conditions are identical for each wafer.

To generate electrical doping in the epi layer, gases such as  $\text{B}_2\text{H}_6$ ,  $\text{PH}_3$ , and  $\text{AsH}_3$  are added to the chlorosilane hydrogen mixture. The doping gases decompose and the doping elements are absorbed or dissolved by the growing silicon layer. Because of their low diffusivity, the dopants diffuse only a short distance into the silicon substrate. Epitaxial layers with net charge carrier concentrations in the range of  $10^{14}$ – $10^{20} \text{ cm}^{-3}$  can be obtained readily. Figures 48.15 and 48.16 show schematically some epitaxial reactors.

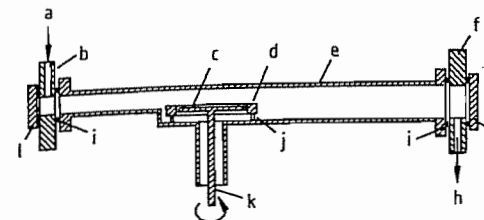

Figure 48.16: Single-wafer epitaxy reactor for large wafers (according to ASM): a) Gas injection; b) Gas injector flange; c) SiC-coated rotating wafer susceptor; d) SiC-coated surn ring; e) Silica process tube; f) Back flange; g) Rear access port; h) Exhaust; i) O-ring; j) Silica surn ring support; k) Rotating susceptor support; l) Gate valve.

#### 48.4.2.6 Characterization

After crystal pulling, the properties of the silicon crystals, particularly the CZ-Si crystals for megabit devices, must be measured and tested in manifold respects. A great and constantly growing number of measuring and testing methods are employed on silicon. The extent of their application depends on the type and use of the respective material. The most common measuring and testing methods are described briefly below.

##### Bulk properties:

- Macroscopic axial and radial distribution of resistivity by two- and four-point probe measurements
- Microscopic resistivity distribution by spreading resistance measurements
- Oxygen and carbon concentrations by Fourier transform infrared absorption (FTIR) measurements
- Oxygen content in samples with high dopant concentration by gas fusion analysis
- Oxygen precipitation behavior in standardized annealings by FTIR measurements and microscopic visual or instrumental determination of the precipitate density and distribution
- Determination of the content of stacking fault nuclei by oxidation tests and microscopic analysis

- Testing of the gate oxide integrity by a gate oxidation and a subsequent electrical measurement
- Trap analysis by measuring the minority carrier diffusion length [e.g., with the surface photovoltage method]
- Concentrations of N, B, Al, Ga, P, As, Sb, C–O complexes, thermal donors, etc., by low-temperature (ca. 8 K) FTIR measurements
- Concentration of electrically active impurities (e.g., metals) and compounds (e.g., FeB) by deep-level transient spectroscopy
- Concentration of impurities by instrumental neutron activation analysis (INAA; detection limit = 0.00001–10 ppba depending on the element)

##### Geometrical and structural wafer properties:

- Thickness, parallelism, and flatness by diverse mechanical, optical, or electrical measurements ( $\geq 0.1 \mu\text{m}$ )
- Chipping off, scratches, spots
- Number and size of particles  $> 0.15 \mu\text{m}$  on the wafer surface
- Roughness and haze on the surface by visual or instrumental optical inspection

##### Purity of the wafer surface:

- determination of diverse elements and compounds by
- Inductively coupled plasma mass spectrometry
  - Total reflection X-ray Fourier analysis
  - Inductively coupled plasma Auger electron spectroscopy
  - Vapor-phase decomposition Auger electron spectroscopy
  - Ion chromatography and other methods

#### 48.4.3 Solar Silicon

Detailed information on solar silicon and its production is given in [5].

A distinction can be made between solar cells for terrestrial applications and solar cells for extraterrestrial applications. In the latter

case, the efficiency (output per square meter) is the most important factor; therefore, the best CZ silicon single-crystal qualities are used. Float-zone silicon is not used for extraterrestrial applications because it degrades too strongly on exposure to cosmic radiation, eventually reaching a lower efficiency than CZ silicon. The CZ silicon is more stable owing to its high oxygen content (ca. 15 ppm).

In the case of terrestrial photovoltaic solar cells, the prevailing opinion was initially that solar silicon should be as cheap as possible, and this led to the development of low-priced silicon of low efficiency for solar applications. However, the majority of the costs of a solar module come not from the silicon wafers but from costs that are proportional to the area of the module and are difficult to reduce. At present, about 30% of the module costs result from the silicon wafers, 30% from the manufacturing of the solar cell structures, and 40% from module costs (metals, glass, machining, etc.). Therefore, recent developments concentrate increasingly on the production of high-efficiency silicon of moderate or low price. High-efficiency silicon means that the purity and crystal quality of the material must be similar to those of silicon for electronic applications (i.e., monocrystalline and free of dislocations and microdefects). Consequently, solar-grade silicon and electronic-grade silicon will be produced by similar methods in the future.

This trend can already be seen in the development of the solar energy market. The market shares of amorphous silicon and nonsilicon solar materials such as  $\text{CuInSe}_2$  and  $\text{CdS}$  are decreasing, while the market shares of multicrystalline silicon and, in particular, single-crystal silicon are increasing.

Table 48.4 shows the situation of the photovoltaic market in 1990 [20–22]. Photovoltaic (PV) modules for 48 MW<sub>p</sub> (p = peak) were produced in total. The value of these PV modules (ca.  $\$400 \times 10^6$ ) was about 0.5% of the value of the electronic devices made from silicon (ca.  $\$90 \times 10^9$ ).

Table 48.4: Solar silicon market in 1990.

| Type of material | Efficiency, % | Module price <sup>a</sup> , \$/W <sub>p</sub> |    | Production      |          |
|------------------|---------------|---|----|-----------------|----------|
|                  |               |   |    | MW <sub>p</sub> | Share, % |
| Mono-Si          | ca. 15        | ca. 4.5                                       | 21 | 44              |          |
| Multi-Si         | ca. 13        | ca. 4.5                                       | 12 | 25              |          |
| $\alpha$ -Si:H   | ca. 5         | ca. 4.5                                       | 15 | 30              |          |
| Others           |               | in development                                |    | ca. 1           |          |

<sup>a</sup> The selling prices are coupled to the output of the modules and not to the manufacturing cost.

#### 48.4.3.1 Crystalline Silicon

At present, the industry uses the same starting material (high-purity CVD polycrystalline silicon) for the production of crystalline solar silicon as is used for the growth of single-crystal silicon for electronic devices. The production of CVD polycrystalline silicon is described in Sections 48.4.2.1 and 48.4.2.2. In 1990, ca. 8000 t of CVD polycrystalline silicon was produced, of which ca. 7000 t was consumed for the production of electronic devices, ca. 700 t for the production of solar cells, and the rest for other applications.

**Monocrystalline Silicon.** For terrestrial solar cells, CZ and FZ silicon single crystals of 0.5–5  $\Omega\text{cm}$ , mostly p-type and sometimes n-type, are used. Float-zone silicon has a market share of about 3% and is used only for manufacturing very high-efficiency solar cells for light concentrators.

For extraterrestrial applications, CZ crystals of higher resistivity (7–13  $\Omega\text{cm}$ ) are used to reduce the degradation of the material by cosmic radiation. The resistivity chosen results from the optimization of the internal resistivity of the solar cell and the diffusion length of the minority charge carriers that are generated by photons and form the electrical current in the solar cell. Increasing the internal resistivity and decreasing the diffusion length reduce the efficiency of a solar cell. The diffusion length of the minority charge carriers is reduced by “traps” that capture the carriers and by too high a dopant concentration. Traps are formed by impurities (e.g., transition metals such as Fe, Mn, Cr, V, and Ti), by small impu-

urity precipitates, and by crystal defects having dangling bonds.

Single-crystal silicon for solar cells is produced in the same way as that for electronic applications. The cylindrical silicon crystals are cut to square ingots and then sawed into slices. Square slices give a more complete area covering than round slices.

At present, the efficiency of PV modules made from monocrystalline silicon reaches 18% in industrial production [23] and 24% in laboratory production [24].

**Multicrystalline silicon** is produced by ingot or sheet crystallization.

**Ingot Crystallization.** Several methods are used to produce multicrystalline silicon ingots:

1. Melting in a crucible and crystallization onto a cold plug, which is immersed in the melt and then withdrawn
2. Melting and solidification in the same crucible
3. Melting in a crucible, and casting and solidification in a mold (Figure 48.17)
4. Quasi-continuous melting in and pulling downward through a so-called cold crucible, which is open at the bottom (Figure 48.18)
5. Quasi-continuous casting through a cold crucible or graphite shaper analogous to (4)

Method (1) is not used for several reasons. Method (2) yields a good crystalline structure owing to its very slow crystallization but includes high crucible costs (crucible is not reusable). Method (3) is the most economical (reusable mold) and also yields good crystal quality. Methods (2) and (3) both yield square ingots, which is a major economic advantage (100% area coverage).

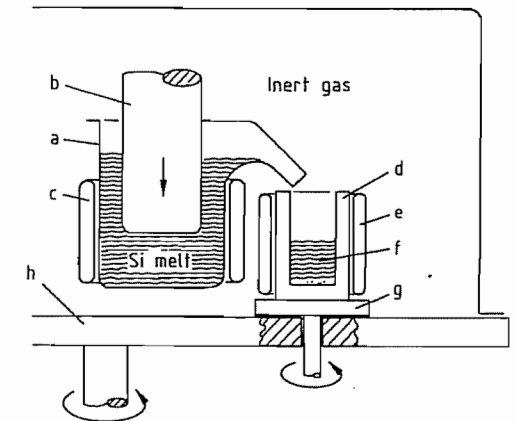

Figure 48.17: Equipment for semicontinuous production of multicrystalline silicon ingots by mold casting: a) Crucible; b) Piston; c) Heater; d) Mold; e) Heating; f) Cast ingot; g) Rotating cooling plate; h) Base plate.

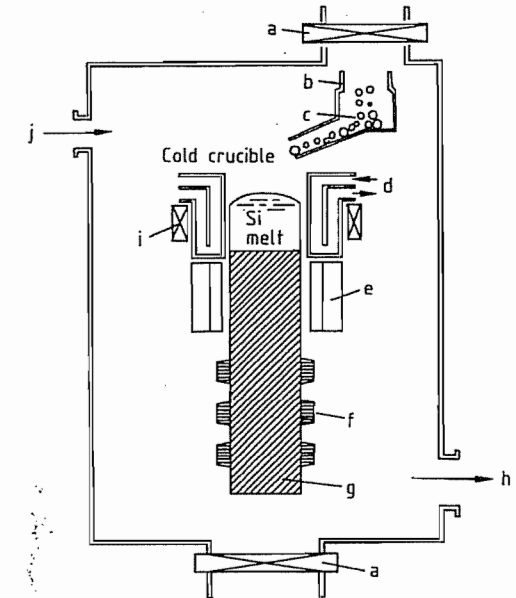

Figure 48.18: Cold crucible induction casting for multicrystalline silicon ingots: a) Valve; b) Granule feeder; c) Silicon granules; d) Cooling water; e) Auxiliary heater; f) Ingot puller; g) Ingot; h) Vacuum port; i) Induction coil; j) Inert gas inlet.

The ingots must be cut into thin slices (200–500  $\mu\text{m}$  thick) for manufacturing solar cells. At present, inner-diameter saws (Figure 48.13) are generally used. However, multiple-wire sawing (Figure 48.19) is gaining in im-

portance. Multiple-wire sawing will be the slicing technique of the future for solar silicon because it results in lower material losses and can cut thinner slices.

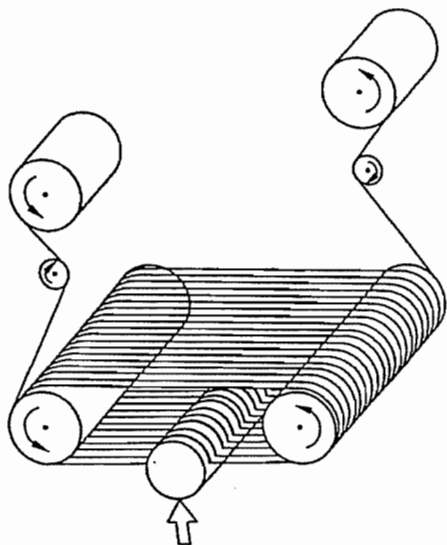

Figure 48.19: Multiple-wire slurry slicing technique. A single cutting wire is wound onto a delivery spool. The wire is arranged in multiple loops around grooved drive and idle rollers and fixed to the take-up spool.

The current efficiencies of multicrystalline solar cells reach 15%.

The advantage of sheet crystallization is that slicing, which causes high machining costs and material loss, is unnecessary. For economic reasons, sheet crystallization must be carried out at a very high growth rate. However, with such a growth rate, the segregation coefficients of the impurities become unity, and the impurities from the bulk and the surface of the starting polysilicon are incorporated completely into the silicon sheet. In contrast, at the low growth rates in single-crystal pulling or ingot crystallization the impurity concentration of the silicon is reduced drastically (e.g., by a factor of 105 for iron). Therefore, the starting silicon for sheet growth must be of a much higher purity than that for crystal or ingot growth.

A second disadvantage is that the very high growth rate leads to poor crystal quality (high density of dislocations and grain boundaries).

The higher content of both impurities and crystal defects results in lower solar cell efficiency. These two major drawbacks may not be overcome in the future.

Figures 48.20 and 48.21 give examples of multicrystalline silicon sheet growth. Many other methods exist for producing such materials [5, 25].

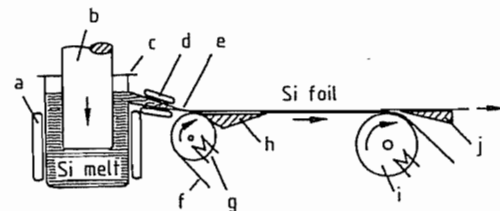

Figure 48.20: Continuous production of silicon ribbons: a) Heaters; b) Piston; c) Crucible; d) Heater; e) Die; f) Foil carrier; g) Heated cylinder; h) Ramp; i) Cooled cylinder; j) Separator.

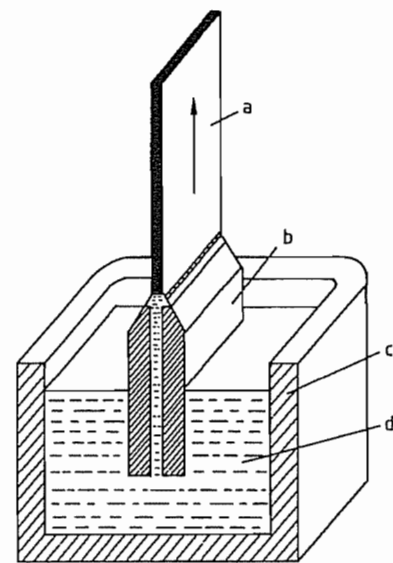

Figure 48.21: Edge-defined film-fed growth (EFG) or capillary action shaping technique (CAST) for the production of silicon ribbons: a) Silicon ribbon; b) Die; c) Crucible; d) Melt.

#### 48.4.3.2 Amorphous Silicon

Amorphous silicon is often abbreviated to  $\alpha$ -Si:H in contrast to c-Si for crystalline silicon. The H in  $\alpha$ -Si:H stands for hydrogen, which is needed to neutralize the detrimental

dangling bonds. Most of the  $\alpha$ -Si:H is used for photovoltaics and is prominent in consumer and low-power applications. In addition to photovoltaics,  $\alpha$ -Si:H is employed for electrophotography, in photodetectors, and in accumulation-model field-effect transistors and other electronic devices. In particular, it can be used in integrated functions.

The  $\alpha$ -Si:H solar cell is a typical thin-film device. The film is ca. 1  $\mu\text{m}$  thick and is manufactured in large areas in integrated thin-film deposition lines (CVD at 470–530 K; see Section 48.4.2.2). The stabilized efficiency of modules in the field is ca. 5%. Multijunction devices incorporating  $\alpha$ -Si:H/ $\alpha$ -Si:H tandems or  $\alpha$ -Si:H/ $\alpha$ -Si:H/ $\alpha$ -Si,Ge:H triple junctions are under development for a stabilized efficiency of 8% [22].

## 48.5 Compounds

A number of inorganic compounds of silicon have gone through a remarkable development in the past years, prompted chiefly by the electronics industry and efforts of environmental protection. A tremendous growth of knowledge in physics and chemistry, as well as technical applications, has taken place around certain hydrides, halides, and oxides of silicon. Progress in solid state physics, the material sciences, and an increase in unwanted by-product formation in the course of production of large-scale silicon compounds have necessitated that one look anew at process engineering. Energy consideration is of direct bearing in this technology since most processes in technical silicon chemistry require high temperature.

Environmental protection and elimination of safety hazards during production and handling of the above silicon products has been the concern of all ever since these compounds became large-scale technical products. The moisture sensitivity of the halides, the oxygen sensitivity of the hydrides, and pyrophoric properties of some of the distillation residues from reaction steps involving elementary silicon or silicides have caused waste problems

and particular emphasis on process safety. Greater flexibility of chemical transformation within at least partly recycling procedures have both decreased waste and enhanced safety. Making use of by-products has been extended to comprise substances of the system C–Si–O Hal, its phases and transformations. Alongside product making, by-product formation, its investigation, suppression, or transformation into useful silicon derivatives has been to some degree due to efforts of environment protection.

With respect to use, many new applications were found for special inorganic silicon compounds, optical fibers and solar cells being example for both surface as well as bulk properties.

Surface treatments, not necessarily confined to protective coatings but including migration beneath the surface, are carried out to increase hardness, thermal stability, to influence cohesion and adhesion, to resist oxidation, erosion, corrosion, and to enhance reflection, etc. Interfaces and multilayer cermets and plastics need silicon in various bonding states as intermediates during production or permanently in a final product.

### 48.5.1 Hydrides

Silicon hydrides are sensitive to hydrolysis and oxidation; volatile higher silanes are spontaneously flammable [26–28]. The first five members of the homologous series  $\text{Si}_n\text{H}_{2n+2}$  are known in the pure state (Table 48.5).

All silanes are decomposed in reactions of the type:

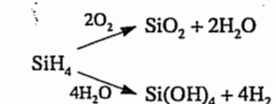

The thermal decomposition of monosilane takes place as follows:

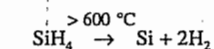

Higher silanes decompose at lower temperature.

High-purity silicon can be produced in this way from pure silanes. Organosilicon compounds can be obtained by addition of silanes to unsaturated organic compounds.

Table 48.5: Silanes  $\text{Si}_n\text{H}_{2n+2}$ .

|                            | mp, °C | bp, °C | $d_4^{20}$ |
|----------------------------|--------|--------|------------|
| $\text{SiH}_4$             | -185   | -112   | 0.68       |
| $\text{Si}_2\text{H}_6$    | -130   | -14.5  | 0.69       |
| $\text{Si}_3\text{H}_8$    | -117   | -53    | 0.72       |
| $\text{Si}_4\text{H}_{10}$ | -91    | -108   | 0.79       |

### 48.5.1.1 Monosilane

Monosilane,  $\text{SiH}_4$ , is formed by the hydrolysis of magnesium silicide ( $\text{Mg}_2\text{Si}$ ) with 10% hydrochloric acid at 50 °C. It is, however, accompanied by higher homologues which must be removed by high-vacuum fractionation [29, 30]. However, if magnesium silicide is hydrolyzed with ammonium chloride in anhydrous ammonia under its own vapor pressure at room temperature,  $\text{SiH}_4$  is obtained exclusively [31]. Ammonium bromide has also been used [32]. The ammonia is condensed out as far as possible, and any remaining traces are removed by washing the silane with dilute nitric acid.

Silane can readily be prepared from silicon halides and metal hydrides. The most convenient laboratory method is the reaction of  $\text{SiCl}_4$  with lithium aluminum hydride in diethyl ether [33] or THF [34].

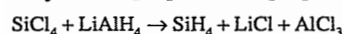

The hydrogenation can also be performed with alkali metal hydride/aluminum alkoxide or alkali metal hydride/boron triethyl in paraffin oil [35], or by alkali metal aluminum hydride/calcium aluminum hydride in other organic solvents [36, 37].

The alkali or alkaline-earth metal hydrides can be formed in situ by passing silicon tetrachloride and hydrogen into an electrolyzed melt of the metal halide [38].

In a two-step process, in which the rate of silane formation is adjusted by means of the temperature difference between the two stages, silicon halides other than the tetrafluoride are first reacted with excess alkali metal hydride or alkali metal aluminum hydride, fol-

lowed by degassing and then contacting the solid reaction product with excess silicon halide [39]. Monosilane is obtained in low yield but with sufficient purity to be used in the manufacture of semiconductors with toluene as a solvent instead of ethers [40].

Benzyltriethylammonium chloride or other quaternary ammonium salts are used as catalysts in concentrations up to 25 mol%. High yields of monosilane are obtained from the reaction of silicon halides with a mixture of aluminum products containing dialkyl aluminum hydrides, trialkylaluminum, ethylaluminum chloride, and aluminum powder in liquid paraffin at 40 °C.

Catalytic disproportionation of chlorosilane mixtures originating from various sources in the silicon industry provides a route to monosilane for the manufacture of polycrystalline solar silicon. For a mixture of trichloro- and dichlorosilane, copper [41], a mixture of silica and alumina at 300 °C [42], and quaternary ammonium groups bonded to carbon in an ion-exchange resin have been reported as catalysts for the main reaction

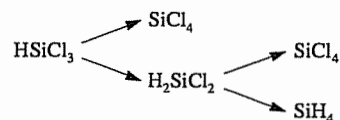

leading to monosilane [43].

The catalytic conversion of intermediate dichlorosilane can also be accomplished by alkyl or aryl nitriles on carbon carriers at 50 °C [44]. Boron catalysts, however, enhance the formation of dichlorosilane in chlorosilane mixtures obtained by high-pressure plasma hydrogenation of tetrachlorosilane [45]:

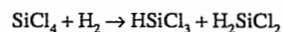

In-process purification is achieved by contacting part of the monosilane produced with the starting mixture of chlorosilanes, which contains the impurities as chlorides, chiefly those of arsenic, phosphorus, and boron. This procedure converts the contaminants into their more volatile hydrides, which are removed with the off-gas [43].

Properties and physical data of monosilane, particularly with regard to obtaining high-purity silicon by chemical vapor deposition, are compiled in [46].

### 48.5.1.2 Disilane

Increasing amounts of hexachlorodisilane are being produced as a by-product of the chlorosilane industry. Since it is of no immediate use, it is subjected to hydrogenation or disproportionation to convert it to useful derivatives, mainly tetra- or trichlorosilane. When the production of amorphous silicon from disilane became commercially viable, the hydrogenation of hexachlorosilane became a feasible alternative to disproportionation. The production of disilane resembles that of monosilane, the reducing agents being metal hydrides, mainly lithium aluminum hydride. The use of di-*n*-butyl ether as a solvent is reported to give a smooth reaction at 35 °C [47]. Addition of lithium hydride increases the yield molar ratios  $\text{LiH}:\text{LiAlH}_4$  of 0.8, 2.0, 12.0, 20.0, and 40.0 resulted in yields of 83, 88, 90, 89, and 70%, respectively. Lithium hydride can be used as the sole reducing agent if aluminum bromide or chloride is added to the ether solvent [48]. Lithium aluminum hydride in refluxing diethyl or diisopropyl ether gave disilane in 88% yield [49].

### 48.5.1.3 Purification

Removal of boron compounds from silanes that are to be used for the production of high-purity silicon is very important. When  $\text{SiH}_4$  is produced from alkali metal hydrides [37], it is recommended that water should be added to hydrolyze boron hydrides under the alkaline reaction conditions. Water vapor is added during distillation for the same reason [50]. Boron compounds can be removed from  $\text{SiH}_4$  by adsorption from the gas phase onto activated carbon or silica carriers loaded with compounds that form complexes with boron compounds ( $\text{AlCl}_3$ ,  $\text{FeCl}_3$ ,  $\text{C}_2\text{H}_5\text{CN}$ ,  $\text{NH}_2\text{CN}$ ,  $\text{PCl}_3$ ) [51].

If alkali metal hydrides MH are reacted in organic solvents, it is often unnecessary to in-

clude a special stage for removing boron compounds from the silicon compounds, as the former react to form boranate complexes under the following conditions:

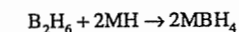
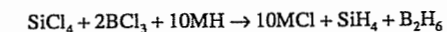

A systematic study has been carried out on the liquid-vapor distribution coefficients of volatile trace impurities in the hydrides of boron, silicon, phosphorus, arsenic, sulfur, and selenium. Experimental and calculated data are reported for the temperature range between the boiling point and critical temperature. Linear regression coefficients for the temperature dependence of the impurity distribution coefficients are included [52].

### 48.5.1.4 Uses

Direct use of silicon hydrides involves their decomposition on surfaces, leading to deposition of elemental silicon or silicon compounds. Polycrystalline films of elemental silicon of controllable grain size are deposited on glass or silica-coated surfaces by heating them to 450–800 °C in an atmosphere consisting of monosilane and tetrabromo- or tetraiodosilane [53]. Chemical vapor deposition is generally followed by annealing and recrystallization with an energy beam. This is used to deposit silicon on insulator surfaces [54]. Amorphous silicon photoconducting layers on electrophotographic plates are made by using a plasma for silane decomposition and silicon deposition [55]. Liquid crystal displays, based on thin film transistors, for screens in monitoring devices, are made from amorphous silicon which is produced on alkali-free glass surfaces in situ by an electric discharge in an atmosphere of monosilane at reduced pressure. Residual bonds are saturated by hydrogen atoms to avoid diminishing the semiconductor effect [56]. On the surfaces of transition metals, cleaned by sputtering in an argon atmosphere, monosilane and the higher silicon hydrides can be thermally decomposed at ca. 300 °C to form metal silicides [57]. Exposure to air leads to the formation of silicon oxides.

### 48.5.1.5 Safety Measures

Silicon hydrides are combustible; the lower members are spontaneously flammable. Particular attention has been given to the system monosilane-oxygen and its explosibility [58]. Oxygen-rich mixtures (> 70% O<sub>2</sub>) give water and silicon dioxide as combustion products. As the mixtures become richer in monosilane, hydrogen replaces water as a combustion product. For monosilane-rich mixtures (> 70% SiH<sub>4</sub>) the products are hydrogen, silicon, and silicon oxides. The explosion of monosilane-rich mixtures is primarily a thermal explosion of monosilane itself.

Hazardous waste gases containing silicon hydrides and halides are passed through columns containing pelletized oxidants to remove the silicon compounds. The oxidants are made by treating a mixture of copper and zinc nitrate with sodium carbonate [59].

### 48.5.1.6 Photochemistry

Irradiation of silanes and silyl compounds leads to fragments, namely the silylene (:SiH<sub>2</sub>) intermediate. Silane mixtures with boron trichloride [60] and hydrogen chloride [61] have been investigated with infrared laser techniques.

Monosilane and boron trichloride react along two pathways, one being hydrogenation of boron compounds, leading to boron dichloride, diborane, and trichlorosilane. In a side reaction, decomposition of silane takes place, forming hydrogen and amorphous silicon. Carrying out this procedure with methane instead of silane leads to a pyrolysis of methane, the released hydrogen partly converting the boron trichloride to hydrides.

In the presence of hydrogen chloride, the primary reaction seems to be the formation of intermediate silylene which in turn reacts with silane and hydrogen chloride. Simultaneous formation of chlorosilanes also occurs. The activation energy for the insertion of silylene into hydrogen chloride was determined to be < 1.3 kcal/mol. In general, silylene insertions are considered in the context of a triplet state,

and symmetry allows insertions to proceed without excitation energy when the antibonding orbital, relating to the bond into which the insertion occurs, is symmetrical with respect to the reaction coordinate [62].

Table 48.6: Melting and boiling points of halogenosilanes.

|                                  | mp, °C             | bp, °C |
|----------------------------------|--------------------|--------|
| SiH <sub>3</sub> F               |                    | -98.6  |
| SiH <sub>2</sub> F <sub>2</sub>  | -119               | -77.5  |
| SiHF <sub>3</sub>                | -131.5             | -97.5  |
| SiF <sub>4</sub>                 | -90.2 <sup>a</sup> | -98.6  |
| SiH <sub>3</sub> Cl              | -118               | -30.5  |
| SiH <sub>2</sub> Cl <sub>2</sub> | -122               | -8.5   |
| SiHCl <sub>3</sub>               | -134               | 36.5   |
| SiCl <sub>4</sub>                | -70                | 57.6   |
| SiH <sub>3</sub> Br              | -94                | 2.0    |
| SiH <sub>2</sub> Br <sub>2</sub> | -70                | 66     |
| SiHBr <sub>3</sub>               | -73.5              | 112    |
| SiBr <sub>4</sub>                | 5                  | 153    |
| SiH <sub>3</sub> I               | -56.5              | 46     |
| SiH <sub>2</sub> I <sub>2</sub>  | -1                 | 149.5  |
| SiHI <sub>3</sub>                | 8                  | 220    |
| SiI <sub>4</sub>                 | 121                | 290    |

<sup>a</sup> At 1753 mbar triple point.

## 48.5.2 Halides

Silicon halides (Table 48.6) are mostly colorless liquids that fume in air, are readily hydrolyzed, and consequently have an irritating effect on the mucous membranes. Silicon hydridoalides with a high hydrogen content are spontaneously flammable. All 18 mixed silicon halides with the composition SiHal<sub>n</sub><sup>1</sup>Hal<sub>m</sub><sup>2</sup> (n + m = 4) are known.

### 48.5.2.1 Trichlorosilane

Trichlorosilane, HSiCl<sub>3</sub>, mp -134 °C, bp 36.5 °C (Table 48.6) is the most important silicon hydridoalide. The vapor is highly flammable; mixtures with oxygen or air explode violently on ignition or on contact with a hot surface. It is decomposed by water with the evolution of hydrogen.

#### Preparation from Elemental Silicon

Trichlorosilane was first prepared by F. WÖHLER, who used the same method as that

now used for laboratory and industrial scale production [63]:

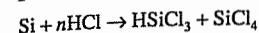

A mixture of chlorinated silanes is produced when a mixture of hydrogen chloride and hydrogen at ca. 250–400 °C is passed over high-silicon (ca. 97% Si) ferrosilicon or silicon mixed with aluminum, nickel, or copper(I) chloride [64]. The process is sometimes carried out in a turbulent [65–67] or nonturbulent fluidized bed [68, 69].

Due to the growing demand for pure precursors for high-purity silicon, process improvements have been made continuously to raise the yield of trichlorosilane and to lower energy consumption as the chief cost cutting measures in production. The fluidized-bed reactor [70–79] has become the predominant process base for the manufacture of trichlorosilane from metallurgical-grade silicon or other silicon solids. Additional feed gases, both inert (e.g., nitrogen, argon, and helium) or reactive (e.g., chlorine) have been used [70, 71]; feeding hydrogen chloride in pulses is reported to give a higher yield [72]. Tetrachlorosilane added to the feed gas serves as a carrier and fluidizing agent when silicon residues are utilized as a source of silicon [73]. These residues can originate from the direct synthesis of organochlorosilanes. Higher temperature in the fluidized bed followed by rapid quenching are reported to increase yield 1.8-fold. Quenching is effected by spraying the top of the bed with tetrachlorosilane at 20 °C such that the reaction gases leaving the reactor are cooled to 400 °C in less than one second [75].

Extremely fine particles of silicon (50–800 μm), obtained by atomizing molten elemental silicon in a nitrogen atmosphere, are claimed to give a high yield of trichlorosilane [76]. A screw conveyor has also been used for producing trichlorosilane from ferrosilicon [80]. Depending on the cooling rate the tetrachlorosilane to trichlorosilane ratio can be adjusted between 4:1 to 0.2:5.

In a two-step [81] process silicon is first reacted with tetrachlorosilane at 1100–1300 °C

and the resulting product is treated with hydrogen chloride. The conversion of tetrachlorosilane to trichlorosilane is 50–60%.

Adding tetrachlorosilane to the hydrogen chloride prior to contact with powdered silicon is claimed to enable complete conversion to trichlorosilane [82].

Silicon powder with 2% copper [83] or 6% copper [84], has been used at 350–600 °C. The yield of trichlorosilane was 7–27 mol% for 2% Cu, and 80–90 mol% for 6% Cu. Much lower temperatures (down to 260 °C) were possible when antimony pentachloride was used as a cocatalyst with copper; the trichlorosilane yield was 21% [85]. Silicon residues from direct synthesis of organochlorosilanes can also be reacted with hydrogen chloride to give trichlorosilane [86].

#### Preparation from Tetrachlorosilane

Tetrachlorosilane, up to now used as a starting material for silica fillers, quartz, and special glasses, has become an important precursor for trichlorosilane. The basic reaction is



Although use of a graphite heating element at 1100–1400 °C has been reported [87], most processes are operated between 800 and 1400 °C. The residence time is critical and is adjusted by quenching or by using a two-step process. The residence time of the feed should be < 2.5 s [88], and quenching carried out below 600 °C within < 1 s [89]. A feed stream of tetrachlorosilane hydrogen mixture with a molar ratio of 1:2 in the absence of silicon at 1100, 1200, and 1500 °C, gave trichlorosilane in 27, 31, and 35%, respectively.

In two-stage processes the reaction with silicon is carried out at lower temperature in the second-stage reactor.

Typical temperatures are 500–700 °C for the first stage, and 300–350 °C for the second [90]. The yield of trichlorosilane can be doubled by adding hydrogen chloride to the gas from the first reactor prior to entering the second [91]. A reaction mixture obtained by pass-

ing tetrachlorosilane and hydrogen through a reactor at 1050–1250 °C is then cooled to 250–350 °C and reacted with silicon in a second reactor [92], giving a product containing 38% trichlorosilane and 61% tetrachlorosilane. It is also possible to react the intermediate dichlorosilylene with hydrogen in a separate reaction chamber [93].

Single-step processes are mostly carried out in fluidized-bed reactors [94, 95] with quenching of the gaseous reaction products. For furnaces operating at ambient pressure, preheating the reactant gases [96], and removing surface oxide coatings from the silicon powder with aqueous acid or alkaline hydrogen fluoride solution raises the trichlorosilane yield to 70% [97]. Pretreatment of silicon can also be carried out with gaseous hydrogen chloride [98]. While particle size of the silicon and its distribution seems to have little influence on the reaction [99], it is strongly affected by catalysts. Copper, the main catalyst, is added as such to the silicon [100–106]. The reaction kinetics have been studied in the presence of copper chloride [107]. The hydrogenation of tetrachlorosilane has an activation energy of 20–25 kcal/mol which is lowered to 10–15 kcal/mol by the catalyst; conversion and throughput are improved.

Copper has also been used with cocatalysts such as metal oxides [108] and metal halides. Aluminum halides give trichlorosilane yields of 20–30 mol% [109–111]; iron and vanadium halides give comparable yields [112–114].

Using nickel salts as cocatalysts [115, 116] between 500 and 600 °C gave trichlorosilane yields of 36% whereas powdered nickel alone gave 27% [117]. Antimony chloride in a pressure reactor gave 21% [118].

Platinum compounds have also been used [119, 120]. Silicon with addition of  $10^{-3}$  mol% platinum black [121] catalyzes tetrachlorosilane conversion at 550 °C to give an 80% yield of trichlorosilane. At the same temperature, platinum on carbon gives a mere 5% yield [122]. Carbon as the sole catalyst has also been reported in a two-step process [123], in a fluidized-bed reactor [124], and in a packed-bed reaction chamber [125], the latter

two giving trichlorosilane yields of 20 vol% and 11 mol%, respectively.

The conversion of tetrachlorosilane to trichlorosilane has also been effected electrolytically [126] with 1,2-dimethoxyethane as a solvent, hydroquinone as hydrogen donor, and tetrabutylammonium perchlorate as supporting electrolyte.

### Purification

Extreme purification of trichlorosilane is necessary if it is to be used for production of high-purity silicon for semiconductors or photoconductors. This is mainly to remove impurities such as chlorides of calcium, aluminum, titanium, copper, magnesium, iron, boron, and phosphorus, which would remain in the silicon formed by hydrogen reduction. The trichlorosilane is treated with complexing agents such as thioglycolic acid,  $\beta$ -naphthylamine, and salts of ethylenediaminetetraacetic acid [127]. An extremely pure product is obtained by extraction with  $\text{CH}_3\text{CN}$  [128]. Other methods include adsorption of the impurities on columns of activated silica [129], activated carbon, ion exchangers [130, 131], titanium sponge [132], or by treatment with acetals [133] or salt hydrates, which cause partial hydrolysis of the impurities [134–136]. The purification of trichlorosilane [137, 138], the development of purity criteria, and industrial control of purity [139] are well developed subjects.

The ultimate aim in trichlorosilane purification is the elimination of trace amounts of boron and phosphorus. Both elements are retained in chemical processing in sufficient amounts to impede or even prohibit certain uses in electronics. Boron impurities are first converted from volatile halides or hydrides to nonvolatile acids or oxides, for example, by passing moist nitrogen into the boilers of a multistage distillation [140]. The addition of 0.1–1.0 g/t of trichlorosilane decreased the boron content from 1.6 ppm to 0.2 ppb. A similar procedure [141] gave 12 ppb residual boron in a one-step distillation. The addition of silica

with at least 0.25% of total hydroxyl groups is also claimed to effect partial hydrolysis [142].

Phosphorus, the other chief contaminant of silicon compounds, is present in chlorosilanes as phosphorous trichloride. During their distillation, it is trapped in the high-boiling residue by complex formation with molybdenum oxychloride and covalent nickel compounds. The phosphorus-metal complexes are thermally stable. Residual phosphorus contents of chlorosilanes distilled were below the analytical detection limit [143, 144]. Manganese dioxide is also reported as a purification agent. It forms phosphorus oxychloride which has a much higher boiling point than phosphorus trichloride and hence remains in the distillation residues [145]. Boron and phosphorus impurities in trichloro- or dichlorosilane can be oxidized with oxygen to give less volatile compounds [146]. Polycrystalline silicon prepared from purified chlorosilanes had residual impurities of 0.1 ppb boron and 0.18 ppb phosphorus.

### Waste Disposal

The in-plant, partly on-line conversion of waste from chlorosilane manufacture and use has two chief sources: distillation residues and off-gases which are both hazardous materials. To provide safety, environment protection, and an economic conversion of material that can be used elsewhere or safely deposited, several procedures have been adopted. Distillation sludge is evaporated in the presence of metal chloride slurries giving chlorosilanes [147] and then hydrolyzed with steam in azeotropic hydrogen chloride which continuously gives additional hydrogen chloride [148].

### Uses

The purity of trichlorosilane greatly influences its end use. High purity silicon is produced by the pyrolysis of trichlorosilane in the presence of hydrogen [149, 150], for which a large number of techniques have been used, e.g., pyrolysis in a fluidized bed [151], pyrolysis in or over molten silicon [152–154], and

epitaxial growth on silicon [155–157] or graphite [158]. Other processes reported include the production of polycrystalline silicon by the pyrolysis of trichlorosilane [159–162], the production of amorphous silicon coatings by CVD [163], and the production of solar silicon [164, 165]. A reactor made of silicon has been described for the pyrolytic process [166].

In fluidized-bed reactors caking of silicon on the inner wall is prevented by starting with a bed of polycrystalline silicon of grain size 700–3000  $\mu\text{m}$ , fluidized by a mixture of trichlorosilane and hydrogen [167]. The polycrystalline silicon granules are continuously removed from the reactor.

Other important uses for trichlorosilane include the manufacture of very finely divided (“micronized”) silica for use as a filler [168], the manufacture of silicon nitride ceramics, sometimes together with metal nitrides [169], the surface treatment of boron and borides [170], the production of free-flowing granulated fertilizers [171], and in screen printing [172].

### 48.5.2.2 Tetrachlorosilane

Silicon tetrachloride,  $\text{SiCl}_4$ , *mp*  $-69.4$  °C, *bp*  $57.3$  °C,  $T_c$   $234.0$ ,  $p_c$   $37.5$  bar,  $V_c$   $326.3$   $\text{cm}^3\text{mol}^{-1}$ , is a clear, colorless liquid that fumes strongly in air and hydrolyzes rapidly in water, producing  $\text{SiO}_2$  gel. When dry, it does not attack steel, and can therefore be transported in steel tanks. It is soluble in benzene, ether, chloroform, and petroleum ether. It reacts with alcohols to give esters of silicic acid. On partial hydrolysis (e.g., with ether–water mixtures), silicon oxychlorides,  $\text{Si}_n\text{O}_{n-1}\text{Cl}_{2n+2}$ , are formed as colorless, viscous liquids. These oxychlorides, together with the corresponding metallic chlorides, are formed when silicon tetrachloride reacts with metal oxides (e.g., of Mn, Cu, Ca, Zn, Mg, Ag, or Hg) in organic solvents [173].

### Production

Silicon tetrachloride is prepared in the laboratory by the reaction of silicon or high-sili-

con ferrosilicon with dry chlorine at  $> 400$  °C. At lower temperature,  $\text{Si}_2\text{Cl}_6$  and other subchlorides are also formed [40].

In industry,  $\text{SiCl}_4$  is mainly produced by reacting ferrosilicon, pure silicon, or silicon carbide with chlorine. Other possible processes include the reaction of  $\text{SiO}_2$  or a  $\text{SiO}_2/\text{SiC}$  mixture with carbon and chlorine (or with  $\text{COCl}_2$  or  $\text{CO}/\text{Cl}_2$  mixture). This older process, which uses silica sand as the cheap raw material, has attracted renewed interest since the introduction of the fluidized-bed reactors.

**From Ferrosilicon (> 90 % Si) or Pure Silicon and Chlorine.** The reaction between silicon and chlorine is exothermic. Therefore, after the reaction has been initiated, cooling must be provided. Ferrosilicon, with a high silicon content, is cheaper than pure silicon, and due to the greater reactivity of the iron, is more readily chlorinated. However, the temperature must be maintained at  $> 400$  °C so that the  $\text{FeCl}_3$  formed is removed, and blockages in the pipework are prevented.

In the Dynamit Nobel process, large pieces of ferrosilicon containing  $> 90\%$  silicon are continuously fed into a furnace at  $> 500$  °C fitted with a cooling jacket. Silicon tetrachloride is formed together with iron chloride and the chlorides of the other elements present in the ferrosilicon, mainly aluminum chloride, calcium chloride, and titanium tetrachloride. The nonvolatile chlorides (e.g.,  $\text{CaCl}_2$ ) remain in the furnace, and are removed from time to time together with unchlorinated components (e.g.,  $\text{SiO}_2$ ).

The volatile chlorides pass out of the furnace and are then partially condensed by cooling. The collecting vessel is maintained at such a temperature that the  $\text{SiCl}_4$  distills over while the  $\text{FeCl}_3$  and  $\text{AlCl}_3$  remain behind. Most of the  $\text{SiCl}_4$  is then condensed out, and the residual gases are cooled to  $-35$  °C, causing any remaining tetrachloride to separate.

The crude silicon tetrachloride still contains small quantities of iron and aluminum chlorides, and also some chlorine, titanium tetrachloride, and hexachlorodisiloxane formed by partial hydrolysis of  $\text{SiCl}_4$  by the

traces of water that enter the furnace during charging. This is purified by simple evaporation and condensation, followed by fractional distillation. In the evaporation process, which is also applied to the residues from the fractional distillation, chlorides of iron and aluminum remain behind along with some of the medium boiling point compounds, i.e., hexachlorodisiloxane and titanium tetrachloride. The crude distillate obtained is fractionated in a double distillation column.

It has been proposed that a molten salt reaction medium should be used [174], and that inert materials such as carbon, aluminum oxide, and silica should be added in both the batch [175] and the continuous process [176].

#### From Silicon Carbide and Chlorine.

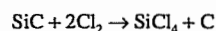

The advantage of using the readily available industrial-grade silicon carbide as the starting material must be balanced against the disadvantages that the reaction with chlorine starts at a higher temperature, and the heat of reaction is not sufficient to maintain the material at the reaction temperature without heating. Also, the carbon formed remains behind as a residue.

Silicon is added to the silicon carbide to facilitate the reaction. The chlorination is carried out in a vertical shaft furnace made of steel or cast iron lined with carbon plates. The downstream condensation system includes a spray of liquid silicon tetrachloride to prevent blockage by the iron and aluminum chlorides formed from impurities in the raw material [177].

In a modified process, the chlorine is mixed with oxygen, which oxidizes some of the carbon formed in the reaction to carbon monoxide [178, 179]:

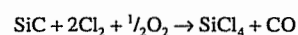

**From Silica, Carbon, and Chlorine.** Information on the temperature required for the reaction of various silica modifications with chlorine and carbon is given in [180].

Chlorides of alkali metals or alkaline earths can be mixed with the finely powdered coke

and kieselguhr or other silica-containing materials to lower the reaction temperature. The mixture is treated with chlorine at red heat [181]. In a variation of the process, the energy is provided by an electric arc, which is applied to the reaction mixture in a fixed [182] or fluidized bed [183].

As the reaction of  $\text{SiO}_2$  with carbon and chlorine is endothermic, it is necessary to couple it with an energy-producing process, e.g., silicon and chlorine, ferrosilicon and chlorine, or silicon carbide and chlorine. In the Stauffer process [184], silicon carbide, silica sand, and coke are treated with chlorine gas in a fluidized-bed reactor. A separator removes any solid material from the gaseous reaction product, which is then cooled in heat exchangers. Silicon tetrachloride condenses out and is purified by the usual distillation process.

**Other Processes.** These include: treatment of silicon or a Si-Cu alloy with  $\text{CCl}_4$  vapor at  $260$ – $300$  °C [185], reaction of alkali metal silicofluorides (e.g.,  $\text{Na}_2\text{SiF}_6$ ) with  $\text{AlCl}_3$  at  $280$  °C [186] or with  $\text{MgCl}_2$  at  $500$ – $1000$  °C [187], and recovery of by-product silicon tetrachloride from the production of methylchlorosilanes.

The formation of incrustations in a fluidized-bed reactor can be prevented if a mixture of metallurgical silicon and silicon carbide with silicates of iron, titanium, vanadium, or chromium is used. Increases in yield of up to 12% have been observed [188].

Lower reaction temperatures, down to  $200$  °C, and the use of silicides, preferably calcium silicide, yields substantial amounts of tetrachlorosilane together with an appreciable amount of hexachlorodisilane [189, 190]. The conversion of higher chlorosilanes into tetrachlorosilane is effected by tertiary amines in catalytic amounts below  $160$  °C. Refluxing of hexachlorodisilane with 0.8 vol% of pyridine gave tetrachlorosilane [191].

#### Purification

The main aim of purification is to remove halides of boron and phosphorus by preferential hydrolysis, complexing agents, or the in-

corporation of adsorption stages in the distillation process. Examples include preferential hydrolysis of  $\text{BCl}_3$  by adding water or ice [192, 193], adding substances to the distillation process that combine with  $\text{BCl}_3$  such as  $\text{CH}_3\text{CN}$  and  $(\text{C}_6\text{H}_5)_3\text{CF}$  [194, 195], substances that combine with  $\text{PCl}_3$  such as  $\text{AlCl}_3$  [196], and passing the silicon tetrachloride through adsorption columns charged with substances containing tertiary amine groups, quaternary ammonium groups [197], or water-containing oxides or silicates [198]. A countercurrent zone-melting process has also been developed for the purification of  $\text{SiCl}_4$  [199].

Removing boron impurities is also accomplished by high-temperature hydrogenation, which converts boron trichloride, the chief impurity to volatile diborane [200]. The fact that considerable amounts of silicon hydrides, chiefly trichlorosilane and dichlorosilane, are formed as by-products, is of no apparent disadvantage since both can now be used in high-purity silicon manufacture.

Low-loss optical fibers require precursors with extremely low contents of hydroxyl-containing impurities. These are probably chloro hydroxy complexes of metals, mainly iron. They are removed by partial hydrolysis of the tetrachlorosilane with adsorption of the impurities on the in situ precipitated silica gel. The residual contaminant content is 12 ppm Fe, 2 ppm OH, and 18 ppm HCl [201].

#### Uses

High-purity silicon is produced by the thermal decomposition of  $\text{SiCl}_4$  in the presence of hydrogen, and highly dispersed silica is produced by flame hydrolysis of  $\text{SiCl}_4$ .

Corrosion-resistant silicon coatings are produced on metal surfaces, e.g., steel and iron [202, 203], molybdenum, tungsten, tantalum [204], molybdenum, or tungsten [205] by heating the metal component in an atmosphere of  $\text{SiCl}_4$ - $\text{H}_2$  or  $\text{SiCl}_4$  at  $1000$ – $1400$  °C.

### 48.5.2.3 Hexachlorodisilane

For years, hexachlorodisilane was a typical by-product; its formation was suppressed as far as possible or a conversion to more versatile products carried out. It is now a compound of its own standing leading directly to the production of several special silicon products. The manufacturing processes, however, are still dominated by the basic reaction of silicon or silicides with chlorine giving a number of chlorosilanes, hexachlorodisilane being just one.

#### Production

To obtain hexachlorodisilane as a high share in a crude chlorosilane product mixture, conversion or degradation processes have been designed. Calcium silicide is the preferred raw material and a low reaction temperature of 200 °C is used [206]. Continuous production in a multicolumn reactor [207], and batch production [208] with a compropor-tion step have been described:

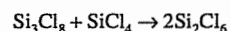

Reaction of ferrosilicon, with a silicon content of 50%, and chlorine at 160 °C in a vibrating reactor gave 55% hexachlorodisilane, and 44% tetrachlorosilane with a 70% ferrosilicon conversion [209, 210].

High-boiling residues, predominantly containing polychloropolysilanes, are cleaved by chlorine in a fluidized bed [211] at 250–450 °C.

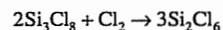

At 500 °C on  $\alpha$ -alumina beads [212] compropor-tion of tetrachlorosilane is readily achieved, with a conversion of 70%. The reverse reaction is carried out at a temperature of 700 °C aided by lithium-magnesium double oxides as catalysts and alumina as the carrier.

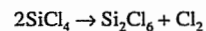

The reaction product consists of 50% un-changed tetrachlorosilane, 40% hexachloro-disilane, and 10% higher homologues [213].

Liquid-phase chlorination allows a lower reaction temperature to be used. Using ele-

mental silicon and a catalyst consisting of the chlorides of sodium, potassium, and zinc gives a product mixture that contains tetrachlorosi-lane, hexachlorodisilane, and tetrachlorodisi-lane in a weight ratio of 12:17:11 [214]. Suspension of silicides and antimony pen-tachloride can be chlorinated to hexachloro-disilane with 34% conversion [215]. In a solvent mixture in which some components exhibit catalytic properties [e.g., perfluoroal-kanes, tris(perfluoroalkyl)amines, and cyclic perfluoroalkyl ethers] elemental silicon reacts with chlorine at 150 °C [216] to give hexachlorodisilane and octachlorotrisilane.

#### Uses

In most of its applications, hexachlorodi-lane can be replaced by other special silicon compounds, but in some cases, the reactions take place at much lower temperature than with tetrachlorosilane or trichlorosilane. The deposition of elemental silicon by purely ther-mal decomposition has been carried out on sil-icron wire at 750 °C [217], on a quartz plate at 500 °C [218], or on quartz crucibles [219].

Hydrogen as a reducing agent has been used to make bulk polycrystalline silicon above 250 °C [220] or to produce atomic lay-ers of silicon by homoepitaxy [221]. A viscous oil obtained by reacting hexachlorodisilane with tetrabutylphosphonium chloride at 200 °C can be pyrolyzed to give finely divided amorphous silicon [222]. The reaction of hexachlorodisilane with propane on graphite surfaces at 700 °C [223] gives  $\beta$ -silicon car-bide. On a cobalt-containing substrate, silicon carbide whiskers are obtained [224]. Mixed carbides of silicon and titanium are made by hydrogenation of a mixture of hexachlorodisilane, titanium tetrachloride, and alkyl halide [225].

Optical fibers can be made by direct surface coating of preforms by flame hydrolysis of hexachlorodisilane [226, 227]. Ultrafine sil-ica particles are formed by thermal decompo-sition of hexachlorodisilane in an oxygen atmosphere [228]. The method is suitable for

the manufacture of quartz glass as a substrate for wave guides [229].

### 48.5.2.4 Other Chlorides

Hexachlorodisiloxane, intermediate or by-product in oxidation or hydrolysis reaction, can be obtained as the chief product by react-ing tetrachlorosilane with sulfur trioxide 500 °C.

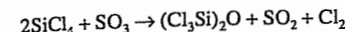

By comparison, other monosilanes react dif-ferently. The bromide and hydride at room temperature give silicon dioxide, the fluoride, not at all even at 600 °C [230]. Formation and degradation of hexachlorodisiloxane can be shown by high-temperature reactions. It is formed from tetrachlorosilane and oxygen [231] together with other oligomeric siloxanes but with mono- and polycyclic siloxanes also. Thermodynamic studies indicate a certain metastability of halosiloxanes in general. No direct use has been made of hexachlorodisiloxane, conversion to chlorosilanes, i.e., recy-cling, is practised [232]:

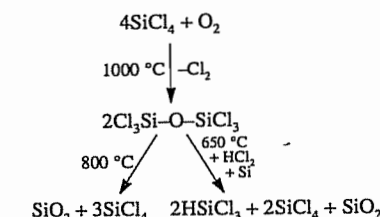

An important intermediate is dichlorosily-lene, the first reaction product of the attack of chlorine on silicon. Dichlorosilylene can be obtained directly in high-vacuum apparatus from the elements at 1250 °C [233, 234], and 1100 °C [235]; it is a transparent, amber-like solid.

### 48.5.2.5 Fluorides

**Difluorosilylene.** Silicon tetrafluoride and sil-icron react at 1200 °C in a high vacuum, yield-ing a condensate with the composition  $(\text{SiF}_2)_x$ . This turns yellow on cooling with liquid air and ignites on contact with atmospheric oxy-

gen. It loses its color on heating to  $-78\text{ }^\circ\text{C}$  and becomes highly polymeric [236].

A plasma flame in an argon atmosphere [237, 238] can also be used as a reaction me-dium. A molar ratio of tetrafluorosilane to sili-con of 0.8:1 gives a  $\text{SiF}_2$  yield of 70%.

Difluorosilylene can be used to produce sil-icron difluoride filaments [239]. The produc-tion of amorphous silicon films from  $\text{SiF}_2$  by chemical vapor deposition leads to material with residual Si-F groups [240], which is claimed to afford a higher doping efficiency [241] for boron and phosphorus.

Reacting  $\text{SiF}_2$  with methane and hydrogen in a glow discharge [242] gives a photocon-ductive amorphous silicon carbide. Silicides can be prepared by reacting hexafluorides of tungsten or molybdenum with difluorosilylene in a hydrogen atmosphere at 300–600 °C [243]. Oxidation of  $\text{SiF}_2$  with oxygen, nitrous oxide, or nitrogen dioxide [244] gives silicon dioxide with residual Si-F groups, suitable for the manufacture of optical fibers.

### 48.5.2.6 Bromides

Silicon tetrabromide, tetrabromosilane,  $\text{SiBr}_4$ , is produced from silicon and bromine vapor at  $> 600\text{ }^\circ\text{C}$ . It is a colorless liquid, with  $mp\ 5\text{ }^\circ\text{C}$  and  $bp\ 153\text{ }^\circ\text{C}$ .

With ferrosilicon powder a 70% yield of  $\text{SiBr}_4$  is obtained. Crude tetrabromosilane is heated with zinc to remove residual bromine [245].

The main use for silicon tetrabromide is as a raw material for the production of silicon and its compounds. The reaction used is the reverse of the preparation method, i.e., it is py-rolytically decomposed [246, 247], usually to-gether with silanes, using fluidized-bed processes [248], or crystal growth techniques [249]. These techniques are also used in the manufacture of optical fibers [250–253] and photoconductive silicon [254].

In a plasma, tetrabromosilane is readily cleaved to the elements, and the deposition of the silicon layer is much faster than with tetra-chlorosilane [255]. Tribromosilane can be pro-duced by reacting metallurgical-grade silicon



with tetrabromosilane at 600–800 °C in hydrogen atmosphere [256].

Other processes include the electrolytic deposition of silicon from solutions of silicon tetrabromide in aprotic organic solvents [257–259].

Silicon tetrabromide is also used to produce silicon nitride itself [260–263], as a coating, or to seal porous solids by exposing them to SiBr<sub>4</sub> vapor followed by reaction with ammonia [264]. Boron–silicon phases have been obtained by the copolyolysis of halogenated silanes and boranes [265].

Silicon tetrabromide is used as an auxiliary in the production of SnO<sub>2</sub> whiskers [266], the etching of aluminum and its alloys [267], and the copolymerization of dienes and vinyl compounds [268].

The entire series of bromosilicon hydrides are obtained by disproportionation [269]. With Amberlite A 21 as catalyst at 135 °C the major product is dibromosilane. Fluorobromosilanes are made by reacting tetrabromosilane with antimony trifluoride [270].

Fluorobromosilicon hydrides are made by reaction with alkyltin hydrides [271] at room temperature under reduced pressure:

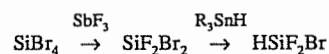

Comproportionation can be extended to the disilanes:

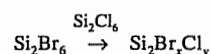

Separation of the products by distillation is difficult due to continuing halogen redistribution [272]. Since aryl groups on silicon can be cleaved by hydrogen halides in the presence of aluminum halide catalysts, this method can be used to prepare higher silicon bromides:

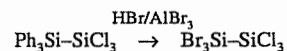

A well-defined, very reactive subhalide with the composition (SiBr<sub>2</sub>)<sub>x</sub> is obtained by the reaction of SiBr<sub>4</sub> and silicon at 1150–1200 °C in a high vacuum. It is a transparent,

almost colorless, amber-like solid, soluble in benzene, xylene, and CCl<sub>4</sub> [40, 273, 274].

### 48.5.2.7 Iodides

Silicon iodide, SiI<sub>4</sub>, *mp* 121 °C, is a crystalline substance that is very sensitive to hydrolysis, decomposes into its elements on heating or on exposure to light, and reacts with oxygen at elevated temperature with liberation of iodine. SiI<sub>4</sub> is produced in 70% yield by passing a carrier gas saturated with iodine vapor over silicon containing 4% copper at 600–700 °C [40]. Silicon tetraiodide can be obtained on the kilogram scale in quantitative yield by passing nitrogen saturated with iodine vapor at ca. 200 °C over granulated silicon at 1150–1200 °C. Approximately 1.5 kg SiI<sub>4</sub> can be produced in 5 h by this method [275].

Other methods include the reaction of mixtures of iodine with bromine or chlorine with silicon at 600–800 °C [276], and heating alkali metal fluorosilicates with alkaline-earth iodides at 500–1000 °C [277] or with aluminum iodide at 300 °C [278].

Like the tetrachloride, tetraiodide can be used for the production of high-purity silicon by thermal decomposition (sometimes in the presence of hydrogen). The silicon tetraiodide can be purified beforehand by repeated sublimation and zone melting [279, 280].

Silicon tetraiodide has some value as an additional reactant in the pyrolysis of silicon hydrides for the production of high-purity silicon [160], in the reduction of other silicon halides in a fluidized bed [281], and for the purification of silicon by zone melting [247].

Silicon tetraiodide is used as a starting material for the preparation of high-purity silicon films for solar cells by electrolyzing a solution of SiI<sub>4</sub> in aprotic organic solvents [257, 258].

Special applications of silicon tetraiodide as a raw material include the manufacture of cermets [255], and of optical fibers with a germanium core and an outer coating of SiO<sub>2</sub> [282]. A subhalide having the composition of diiodosilylene has been reported [28].

## 48.5.3 Oxides

For silicon dioxide, see Section 48.7.

With the oxides, more so than with the halides, the growth of interest in use and production, i.e., formation, is brought about by the same driving forces as for the halides, i.e., electronics manufacture and environment protection.

Sources of silicon oxides are chiefly high-temperature processes in heavy industry like blast furnaces, carbide manufacture, coke making, and silicate processing. Main uses are found in high-tech precision preparation of chips, wafers, integrated circuits, layers, and coatings.

### 48.5.3.1 Monoxide

Silicon monoxide, SiO, is formed initially as a gas when SiO<sub>2</sub> and silicon, or SiO<sub>2</sub> and an amount of carbon insufficient for complete reduction, are heated to > 1250 °C. It therefore plays a part in the industrial production of silicon and silicon carbide from SiO<sub>2</sub> and carbon, and in the production of ferrosilicon [283, 284].

At lower temperature (ca. 600–1000 °C), SiO disproportionates into silicon and silicon dioxide:

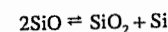

There has, therefore, been prolonged controversy over the question whether SiO should be considered a true compound. Nevertheless, rapid chilling of the gas to room temperature enables the monoxide to be obtained in a solid metastable state. It has a wide range of uses as an additive in applied solid-state physics, and as a raw material in the production of other silicon compounds.

### Production

A stoichiometric mixture of finely powdered SiO<sub>2</sub> and silicon in a reaction tube closed at one end is heated at its lowest point in a high vacuum for ca. 4 h at 1250 °C. A brown mixture of SiO<sub>2</sub> and Si, formed by disproportionation, collects in a short transition

zone in the part of the tube that just protrudes from the furnace, and the SiO collects as black, compact, shellac-like masses in the parts further away from the furnace.

If an intimate mixture of SiO<sub>2</sub> and silicon is heated for 9 h to 1300 °C and rapidly chilled, cubic crystals of SiO are formed [40]. On an industrial scale, the monoxide can be produced by heating SiO<sub>2</sub> with silica, carbon, or silicon carbide to 1500–1800 °C in a resistance furnace [285, 286].

Heating the vapors of the reaction

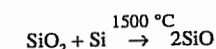

to 1800 °C in an ammonia atmosphere gives amorphous silicon monoxide powders [287].

Silicon monoxide can be made directly in the form of fibers by reducing sand flour with methane at 2500 °C in a fluid-wall reactor [288].

The formation of silicon monoxide by side reactions or as a by-product of the main process takes place in the course of a number of industrial production streams. In terms of chemical categories these production steps are based on reductions as well as oxidations.

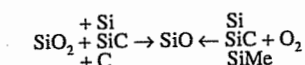

### Properties

At room temperature, silicon monoxide is a light brown, finely divided powder, or, if it has been produced by slow condensation, it is a black or very dark brown, shellac-like, glassy mass. The lower limit of stability for gaseous SiO is not below 1025 °C, and is very probably > 1175 °C [289]. The best temperature range for its production from SiO<sub>2</sub> and Si is 1200–1400 °C [290–292].

At 600 °C, SiO decomposes in several hours, at 700–900 °C in ca. two hours, and at 1000–1200 °C almost instantaneously into SiO<sub>2</sub> and silicon [291, 293]. Oxygen causes surface oxidation to SiO<sub>2</sub> even at room temperature, and complete oxidation takes place at ca. 500 °C. Finely divided SiO is pyro-

phoric and burns with flame formation if there is rapid access of air.

With the increase in the number of possible uses for SiO, the silicon-oxygen system has been the subject of extensive investigations [294], particularly with regard to suppressing the formation of SiO during the production of high-purity silicon [295], and of Si-O-N mixed phases in atmospheres containing O<sub>2</sub> and N<sub>2</sub> [296].

### Uses

Silicon monoxide is used in small quantities to produce protective films on semiconductors [297–299], vidicon targets [300], and in antireflective coatings on optical glass and plastics [301–304]. Silicon monoxide prevents the formation of anatase in rutile coatings on glass [305]. In entertainments electronics and data processing, silicon monoxide is used in recording tape, other types of data storage media, data transfer heads [306, 307], and in the alignment of liquid crystals for digital displays [308, 309]. Other applications include the coloring of glass surfaces by the simultaneous or sequential deposition of metals and silicon monoxide [310].

Another application of silicon monoxide electronics is the manufacture of heat-resistant films and devices in which corrosion resistance is required. It can be used as a heat-resistant protective layer in laser recording media [311], and in multilayer thermal heads for thermographic printers [312]. Multilayer devices consisting of aluminum, germanium, and silicon monoxide are selective solar absorbers for thermal conversion [313]. Ceramics consisting of silicon carbide whiskers in a graphite matrix can be reinforced by decreasing the porosity by filling the voids with silicon prepared in situ [314].

Silicon monoxide is used as a raw material, a construction material, and as an auxiliary. The best known application is the oxidation of gaseous silicon monoxide to amorphous finely divided silica [315]. Other uses include the production of silicon carbide [316, 317], silicon nitride [318–320], Si-O-N mixed phases

[321], and cermets [322, 323]. Silica can be removed from silica-containing materials (e.g., kaolin) by adding silicon and heating the mixture at 1450 °C in a vacuum [324–326]:

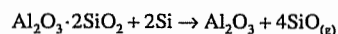

Silicon monoxide can be used to remove phosphorus from blast furnace slag, allowing it to be recycled [327].

Hard coatings of SiO<sub>2</sub> on metals, especially on metallic mirrors, can be produced by deposition of SiO from the vapor state. The SiO is then oxidized by atmospheric oxygen to form SiO<sub>2</sub>.

In the production of silicon nitride ceramic powders, silicon monoxide is reacted with a reducing atmosphere consisting of a mixture of ammonia and hydrocarbons at 1000 °C. When methane is used as sole reductant, the product is cubic β-silicon carbide [328].

A convenient method to prepare members of the halosilane family is the reaction of silicon monoxide with hydrogen halides [329].

Low-silicon metals are produced by effecting silicon depletion of the melt by limited oxidation. In the production of high-purity vanadium, vanadium pentoxide is added to the melt and the silicon monoxide formed is evaporated [330]. Silicon in molten indium is oxidized with water in a hydrogen atmosphere at 800 °C; ca. 90% of the initial silicon content is converted to SiO [331].

### 48.5.3.2 Sesquioxides

Depending on temperature and pressure, the following disproportionation steps can take place:

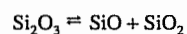
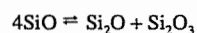

When the monoxide is evaporated at reduced pressure the vapor invariably condenses as the sesquioxide, Si<sub>2</sub>O<sub>3</sub> [332].

The reaction of sulfur trioxide with hexabromodisilane at room temperature affords an almost quantitative yield of the sesquioxide; no cleavage of the Si-Si bond takes place [333]:

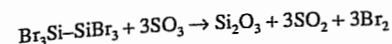

The sesquioxide can be prepared from hexachlorosidilane by hydrolysis via a sol-gel route [334].

Polymeric silicon sesquioxide can be prepared by thermal dehydrogenation of silicon oxyhydride in high vacuum [335].

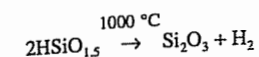

Silicon sesquioxide can be prepared in situ on surfaces. Plasma vapor deposition from a mixture of monosilane and nitrous oxide [336] gives a moisture-resistant film of silicon sesquioxide, used as a protective layer for *p*-Si substrates. On polycarbonate sheets, Si<sub>2</sub>O<sub>3</sub> layers are prepared by electric discharge [337] or vacuum deposition [338]. On polyethylene [339] a Si<sub>2</sub>O<sub>3</sub> layer has been applied by sputtering with an oxygen plasma, using silicon monoxide as the silicon source.

The suboxides, the sesquioxide being the predominant species, are present in semiinsulating films of polycrystalline silicon [340]. Annealing at 1100 °C converts the other suboxides to the sesquioxide only. The suboxides are also formed on etched surfaces of silicon [341] and in layers obtained by silicon implantation oxidation [342]. Thermal annealing leads to a composition corresponding to that of the sesquioxide when carried out at 600 °C.

Less for effects in high-tech physics than essentially in basic chemical processes, the sesquioxide has found quite different applications. Cleaning and purification spans from that of arsenic vapors [343] to the treatment of waste fluid from sweet potato processing [344]. Highly permeable membrane separation elements are made from a ceramic material based on alumina and silicon sesquioxide [345]. The material is stable in aqueous environment having a water penetration rate of 4.2 m<sup>3</sup>/m<sup>2</sup>h<sup>-1</sup>. In ceramic material the sesquioxide has been used as an oxidizing agent during manufacture [346] and as bits for welldrilling [347]. Wear resistance is much lower though, than for tungsten carbide.

### 48.5.3.3 Other Silicon-Oxygen Compounds

Oxyhydrides of the composition (HSiO<sub>1.5</sub>)<sub>x</sub> are obtained by the hydrolysis of trichlorosilane [348–350]. In organic solvents the product is formed as an amorphous powder or as transparent mica-like flakes [335], depending on the type of solvent. Well-defined, low molecular oligomers—the smallest [351, 352] being a cage of 8 silicon atoms arranged at the corners of a cube with 12 oxygen atoms forming the bridges along the edges—can be prepared by hydrolysis in a two-phase system [353–355]. Oligomers with *x* an even number ranging from 8 to 16 are obtained.

The Si<sub>8</sub>-cube is also the smallest cage in zeolite structures; it is the 4-4 secondary building unit in zeolite A. Since the silver zeolite reacts with water evolving oxygen, ligand-to-metal charge transfers in the Si<sub>8</sub>-cube are of interest in the context of processes involving photolysis of water by visible light [356]. By photochemical oxidation of tetrachlorosilane the trichlorosilanol is produced, a compound existing only in equilibria with others [357]. Utilizing structural possibilities new silicon-oxygen compounds were prepared, the oxygen taking part as the donor atom in penta-coordinate silicon alkoxide complexes. Alkoxysilanes react with metal hydrides to trialkoxy anions which then rearrange to the tetraalkoxy anion [358]

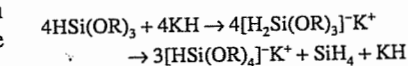

Likewise the reaction of silica with glycol is made possible through penta-coordinate complex formation around the silicon atom [359].

### 48.5.4 Sulfides

Silicon sulfide, SiS<sub>2</sub>, *mp* 1090 °C, sublimation point 1130 °C, forms white, asbestos-like needles, which readily hydrolyze. It is formed from silicon and sulfur at 1100–1300 °C [360], but preferably at > 1400 °C [361, 362]. Silicides react with sulfur at > 700 °C, hydrogen sulfide at 1100–1200 °C, or sulfur chlo-

rides (e.g.,  $S_2Cl_2$ , at its boiling point of 135 °C). The  $SiS_2$  formed must be recovered from the other reaction products (e.g.,  $MgS$ ) by sublimation.

The simplest laboratory method consists of a combination of these two processes. The reaction of  $Mg_2Si$  with  $S_2Cl_2$  is used to start the reaction of silicon with sulfur. A mixture of 3 parts by weight of Si, 0.5 parts by weight of  $Mg_2Si$ , and 8 parts by weight of sulfur is impregnated with 1 part by weight of  $S_2Cl_2$  in a glass tube and heated at one point with a small flame. The reaction starts with a glow. The  $SiS_2$  formed is sublimed off in a vacuum [361].

On a large scale,  $SiS_2$  can be produced by the thermal decomposition of esters of thiosilicic acid. The ethyl ester decomposes at 300 °C:

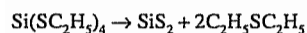

The reaction temperature can be lowered to 200 °C by adding sulfur [361, 363].

The formation of silicon-sulfur compounds, including  $SiS_2$ , has also been observed during the drilling of holes in crystalline silicon plates by laser beams in an atmosphere of sulfur hexafluoride [364].

Direct synthesis from the elements is still being carried out and improved. Continuous feeding into reactors [365] allows a lower reaction temperature of 800 °C to be used. Under a pressure of 2.5–6.0 GPa and 1000–1200 °C the conversion to the sulfide is almost complete, yielding four different polymorphic modifications of silicon sulfide [366].

Silicon disulfide can be conveniently obtained from silica, carbon, and sulfur vapors in an atmosphere of hydrogen sulfide above 1130 °C [367]. The product consists of glassy solid and needle-like crystals.

Silicon disulfide reacts with ammonia to give silicon nitride,  $Si_3N_4$ . Between 800 and 1400 °C the nitride is obtained as an amorphous powder. If a lower temperature and silicon disulfide in the form of whiskers are used, the product retains the morphological characteristics and consists of silicon nitride whiskers [368].

Because of their volatility, the formation of silicon sulfides at high temperature is utilized for desilicization in purification processes. For example, pure zirconium oxide is obtained by conversion of silica impurities followed by vaporization at 1300 °C [369]:

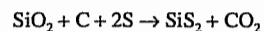

Glassy phases containing silicon disulfide can be used as solid electrolytes in conducting glasses for batteries, especially microbatteries. A system consisting of a  $Li_2S-SiS_2(P_2S_5)$  phase between a  $Li/V_2O_5-TeO_2$  couple has an open circuit voltage of 2.8–3.1 V [370, 371].

From a melt of equimolar amounts of silicon disulfide and lithium sulfide, lithium silicon sulfide is obtained in three phases: equilibrium, metastable crystalline, and glassy  $Li_2SiS_3$  [372]. The conductivity is greatly enhanced by the addition of lithium bromide [373, 374], iodide [375, 376], or chloride [374]. The highest conductivity reported [358] is 1.8 s/cm at 25 °C, measured in a glass consisting of the phase  $0.24SiS_2-0.36Li_2S-0.4LiI$ .

Glassy phases containing silicon disulfide are also obtained by the action of elemental silicon on arsenic sulfide [377]

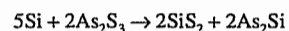

**48.5.5 Borides**

The long-known binary silicon borides,  $SiB_3$  and  $SiB_6$ , are produced simultaneously when the constituent elements are heated between carbon electrodes in an electric furnace [378]. Phases with the composition  $SiB_4$  have since been produced and evaluated for a large number of application areas.

The compound  $SiB_4$  is produced from its elements at 1090–1370 °C by resistance heating and is purified by treatment with a mixture of nitric and hydrofluoric acids. It can also be produced from boron trioxide and silicon [379]. It is used as a refractory material in blast furnaces. Its use as a catalyst for the liquid-phase oxidation of alkenes with organic hydroperoxides to form oxiranes has also been reported [380]. Mixed phases of silicon

borides and molybdenum silicides resistant to oxygen up to 1600 °C are prepared by sintering a pasty mixture of these materials with colloidal silica at 1300–1500 °C. They can be used as abrasives and as highly refractory materials [381].

**48.6 Silicides**

**48.6.1 General**

Silicides are compounds of silicon with a metal. Figure 48.22 shows the currently known silicide phases, arranged according to the position of the metal in the periodic table [382, 383].

Many metals of groups 1–3 and most transition metals form silicides. Physical properties and structures of silicides are summarized in [382, 383]. The corresponding binary phase diagrams often show the existence of several compounds, having mainly nonstoichiometric compositions and intermetallic character. Production processes for silicides are based on the following reactions:

- Fusing or sintering of the metal with silicon:  
 $M + Si \rightarrow MSi$
- Reduction of metal oxides by silicon:  
 $MO + Si \rightarrow MSi + SiO_2$
- Reaction of metal oxides with  $SiO_2$  and carbon:  
 $MO + SiO_2 + C \rightarrow MSi + CO$
- Aluminothermic reaction:  
 $MO + SiO_2 + Al \rightarrow MSi + Al_2O_3 + \text{slag}$

Silicides have an iron-gray, metallic luster and are resistant to oxidation. Most of the compounds shown in Figure 48.22 are currently of only academic interest. The silicides of molybdenum, iron, and calcium have achieved commercial significance.

Molybdenum disilicide, a brittle alloy that is very resistant to oxidation, is used as an alloy for heating conductors. It is converted to cermets, from which resistors are then made. Ferrosilicon and calcium silicon are produced in large quantities for use as alloying and refining reagents in steelmaking and casting.

|                                  |                    |                                 |  |                                 |                                 |                                 |                                 |                                 |                    |                                 |                    |  |  |
|----------------------------------|--------------------|---------------------------------|--|---------------------------------|---------------------------------|---------------------------------|---------------------------------|---------------------------------|--------------------|---------------------------------|--------------------|--|--|
| H <sub>4</sub> Si                |                    |                                 |  |                                 |                                 |                                 |                                 |                                 |                    |                                 |                    |  |  |
| Li <sub>15</sub> Si <sub>4</sub> |                    |                                 |  | Ti <sub>5</sub> Si <sub>3</sub> | V <sub>3</sub> Si               | Cr <sub>3</sub> Si              | Mn <sub>3</sub> Si              | Fe <sub>3</sub> Si              | Co <sub>3</sub> Si | Ni <sub>3</sub> Si              |                    |  |  |
| Li <sub>2</sub> Si               |                    |                                 |  | TiSi                            | V <sub>5</sub> Si <sub>5</sub>  | Cr <sub>5</sub> Si <sub>2</sub> | Mn <sub>5</sub> Si <sub>3</sub> | Fe <sub>5</sub> Si <sub>3</sub> | Co <sub>5</sub> Si | Ni <sub>5</sub> Si <sub>2</sub> |                    |  |  |
| NaSi                             | Mg <sub>2</sub> Si |                                 |  | TiSi <sub>2</sub>               | VSi <sub>2</sub>                | CrSi                            | MnSi                            | FeSi                            | CoSi               | NiSi                            |                    |  |  |
|                                  |                    |                                 |  | CrSi <sub>2</sub>               |                                 | CrSi <sub>2</sub>               | MnSi <sub>2</sub>               | FeSi <sub>2</sub>               | CoSi <sub>2</sub>  | NiSi <sub>2</sub>               |                    |  |  |
| KS                               | Ca <sub>2</sub> Si | Sc <sub>5</sub> Si <sub>3</sub> |  | Zr <sub>4</sub> Si              | Nb <sub>4</sub> Si              | Mo <sub>3</sub> Si              |                                 |                                 | Ru <sub>2</sub> Si | Rh <sub>2</sub> Si              | Pd <sub>3</sub> Si |  |  |
| KS <sub>6</sub>                  | CaSi               | ScSi <sub>2</sub>               |  | Zr <sub>2</sub> Si              | Nb <sub>5</sub> Si <sub>3</sub> | Mo <sub>3</sub> Si <sub>3</sub> |                                 |                                 | RuSi               | Rh <sub>5</sub> Si <sub>3</sub> | Pd <sub>2</sub> Si |  |  |
|                                  | CaSi <sub>2</sub>  |                                 |  | Zr <sub>3</sub> Si <sub>2</sub> | NbSi <sub>2</sub>               | MoSi <sub>2</sub>               |                                 |                                 | RuSi <sub>2</sub>  | Rh <sub>3</sub> Si <sub>2</sub> | PdSi               |  |  |
|                                  |                    |                                 |  | Zr <sub>5</sub> Si <sub>5</sub> |                                 |                                 |                                 |                                 |                    | RhSi                            |                    |  |  |
|                                  |                    |                                 |  | ZrSi                            |                                 |                                 |                                 |                                 |                    | Rh <sub>2</sub> Si <sub>3</sub> |                    |  |  |
|                                  |                    |                                 |  | ZrSi <sub>2</sub>               |                                 |                                 |                                 |                                 |                    |                                 |                    |  |  |
| RbSi                             | SrSi               | Y <sub>5</sub> Si <sub>4</sub>  |  | Hf <sub>2</sub> Si              | Ta <sub>4,5</sub> Si            | W <sub>5</sub> Si <sub>3</sub>  | Re <sub>3</sub> Si              | OsSi                            | Ir <sub>3</sub> Si | Pt <sub>3</sub> Si              |                    |  |  |
| RbSi <sub>6</sub>                | SrSi <sub>2</sub>  | Y <sub>5</sub> Si <sub>3</sub>  |  | Hf <sub>3</sub> Si <sub>3</sub> | Ta <sub>2</sub> Si              | WSi <sub>2</sub>                | Re <sub>5</sub> Si <sub>3</sub> | OsSi <sub>2</sub>               | Ir <sub>2</sub> Si | Pt <sub>2</sub> Si              |                    |  |  |
|                                  |                    | YSi                             |  | Hf <sub>3</sub> Si <sub>2</sub> | Ta <sub>5</sub> Si <sub>3</sub> |                                 | ReSi <sub>2</sub>               | OsSi <sub>3</sub>               | IrSi               | PtSi                            |                    |  |  |
|                                  |                    | YSi <sub>2</sub>                |  | HfSi                            | TaSi <sub>2</sub>               |                                 |                                 |                                 | IrSi <sub>2</sub>  |                                 |                    |  |  |
| CsSi                             | BaSi               | LaSi <sub>2</sub>               |  | HfSi <sub>2</sub>               |                                 |                                 |                                 |                                 | IrSi <sub>3</sub>  |                                 |                    |  |  |
| CsSi <sub>8</sub>                | BaSi <sub>2</sub>  |                                 |  |                                 |                                 |                                 |                                 |                                 |                    |                                 |                    |  |  |

Figure 48.22: Silicides in the periodic table [382].

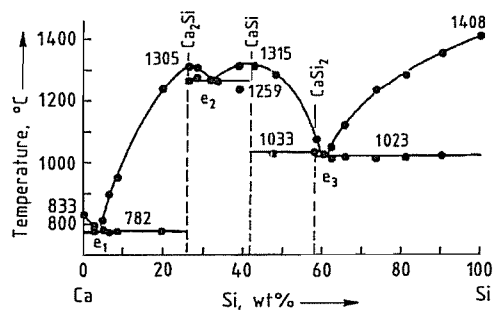

Figure 48.23: Calcium-silicon phase diagram [385].

## 48.6.2 Calcium Silicon

Like FeSi, calcium silicon [384] is produced carbothermally in submerged arc furnaces and is consumed in the iron and steel industry.

**Physical Properties.** The Ca-Si phase diagram (Figure 48.23) shows the existence of three compounds [385]:  $\text{Ca}_2\text{Si}$  (cubic,  $a = 474$  pm),  $\text{CaSi}$  (orthorhombic,  $a = 391$  pm,  $b = 459$  pm,  $c = 1080$  pm), and  $\text{CaSi}_2$  (hexagonal rhombohedral,  $a = 1040$  pm,  $\alpha = 21.5^\circ$ ). Commercial CaSi contains ca. 30% calcium and 60% silicon; the remainder is iron and impurities. The alloy solidifies mainly as  $\text{CaSi}_2$  with small amounts of primary and secondary eutectically precipitated silicon. The density of the commercial alloy is  $2.2 \text{ g/cm}^3$ , and its melting range is  $1050\text{--}1150^\circ\text{C}$ .

**Raw Materials and Production.** The raw materials for the production of CaSi are quartz, lime, and coal. Whereas calcium carbide was formerly used as the source of calcium, it has now been replaced by lime with the following approximate specifications:  $\text{CaO}$  94–97%,  $\text{CO}_2$  1.5–3%,  $\text{H}_2\text{O}$  0.5–1.5%.

The requirements for quartz and coal, as well as the particle size of the burden, correspond to those of ferrosilicon production.

The three-phase submerged arc furnaces generally used for the production of CaSi are similar to the furnaces used for the production of FeSi (see Figure 48.2). In practice, CaSi and FeSi are also produced alternately in the same furnace. Calcium silicon is produced only in open furnaces whose power consump-

tion is 8–30 MW, corresponding to a capacity of  $(6\text{--}20) \times 10^3$  t/a. The basic reaction of the commercial process is as follows:

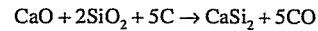

In practice the processes are very complex. The process is sensitive to variations in the amount of reducing agent, which may also occur locally in the burden. An excess of carbon in the burden results in the formation of SiC and  $\text{CaC}_2$ , which in the extreme case leads to the clogging of the furnace. The use of too little carbon results in the formation of lime-silicate slags that are difficult to reduce and are tapped with the metal, which lowers the capacity of the furnace.

Even with correct operation, up to 30% of slag is carried out with the CaSi. The slag, which is only slightly denser than CaSi, is separated after being tapped off into the pouring ladle. The slag sinks to the bottom, and the metal is then decanted by pouring into shallow molds. Some companies use a cascade of four to five tapping-off molds, which results in refinement because the slag preferably remains in the upper molds and the lower ones contain very pure metal. Careful separation from slag is the only feasible method for refining CaSi. The oxidative treatment used for FeSi is not possible because calcium has a high affinity for oxygen.

The slag, which also contains  $\text{CaC}_2$ , is processed and recycled to the furnace. Typical values for the specific material and energy requirements of the CaSi process are as follows:

|                   |                   |
|-------------------|-------------------|
| Quartz            | 1500–1800 kg/t    |
| Lime              | 550–700 kg/t      |
| Coal              | 680–800 kg/t      |
| Recycled slag     | 250–300 kg/t      |
| Söderberg paste   | 80–100 kg/t       |
| Power consumption | 9800–13 000 kWh/t |

**Environmental Protection.** The large amount of dust generated in the CaSi process (up to 300 kg per tonne of CaSi) is a result of vapor losses of  $\text{SiO}_2$  and calcium. Both components are oxidized in air and carried out of the furnace with the off-gas, from which they are separated in bag filters. The dust, which consists of ca. 60%  $\text{SiO}_2$  and 30% CaO (remainder:  $\text{MgO}$ , carbon,  $\text{Fe}_2\text{O}_3$ ), is dumped.

Table 48.7: Composition of CaSi (DIN 17580).

| Name                   | Symbol   | Material no. | Composition, % |                |          |           |          |          |
|------------------------|----------|--------------|----------------|----------------|----------|-----------|----------|----------|
|                        |          |              | Ca             | Ca + Si (min.) | C (max.) | Al (max.) | P (max.) | S (max.) |
| Calcium-silicon        | CaSi     | 0.3650       | 29–33          | 90             | 1.20     | 1.80      | 0.070    | 0.060    |
| Calcium-silicon, low C | CaSiC 50 | 0.3655       | 29–33          | 90             | 0.50     | 1.80      | 0.070    | 0.050    |

Since all of the slag is reintroduced to the process, none remains to be disposed of.

**Quality Specifications.** The specifications for standard-grade commercial CaSi are summarized in Table 48.7. A number of multicomponent CaSi-based alloys contain up to 30% aluminum, manganese, barium, titanium, magnesium, mischmetal, or iron. These compositions are often specified by the customer and are not defined in standards.

DIN 17580 also defines procedures for analysis, testing, and arbitration [386, 387, 388].

**Storage, Transport, and Toxicology.** On contact with water, acid, or base, CaSi can produce hydrogen. The reaction proceeds extremely slowly with pure water and the alloy is therefore not classed as a hazardous substance in most countries (GGVS/GGVE) for transport by road.

For sea and air transport, CaSi is classed as a hazardous substance, Class 4.3 (IMDG-Code; UN no. 1405). Since fine CaSi dusts are explosive, inert gases (nitrogen or argon) must be used for pneumatic transport. The critical oxygen content for carrier or protective gases is 8%.

Calcium silicon should be stored in dry, ventilated rooms. On contact with moisture, slag impurities can release small amounts of phosphine, although with correct storage the concentrations are not critical.

**Uses.** Calcium silicon is used in steelmaking as a deoxidizer and desulfurizer, as well as for the modification of nonmetallic inclusions [389, 390]. Calcium is the active element in the alloy due to its high affinity for oxygen and sulfur; silicon serves as a carrier element and is alloyed in the steel melt, analogous to FeSi.

The efficiency of calcium is very low if the alloy is added in lumps because of the high va-

por pressure of calcium at the utilization temperature ( $p_{\text{Ca}}$  at  $1600^\circ\text{C}$ : 0.2 MPa) and the low solubility of calcium in molten iron (max. 0.03 %).

The efficiency has been improved by the development of injection techniques. Calcium silicon powder is blown deep into the steel melt through immersion lances, or CaSi-filled hollow wires are coiled rapidly in the pouring ladle. These techniques produce very good metallurgical results and are rapidly replacing conventional addition of the alloy as lumps.

The modification of inclusions by calcium improves the fluidity of steel in automated continuous casting plants. The calcium liquefies the suspended solid inclusions of aluminum oxide that are always present in aluminum-killed steels. Furthermore, the material properties of the steel are improved: the calcium aluminates formed are largely undeformable in the solidified steel and allow high isotropy of the material properties to be maintained after working of the steel.

**Economic Aspects.** The amount of CaSi required by the steel industry has decreased during the 1980s due to changes in process technology: the very efficient injection techniques, especially the cored wire process, greatly reduce the amount of CaSi required per tonne of steel.

In spite of the wide range of uses, world consumption fell from ca.  $100 \times 10^3$  t/a in 1981 to ca.  $80 \times 10^3$  t/a in 1991. In the Western steel-producing countries, ca. 50% is used in the form of filled wire, and this fraction will increase further.

Production capacity is estimated to be  $120 \times 10^3$  t/a, distributed evenly among the former Eastern-bloc countries, South America, and Western Europe.

## 48.7 Silica

### 48.7.1 Silica Modifications and Products

#### 48.7.1.1 Geochemistry and Crystal Structure

Silica, silicon dioxide,  $\text{SiO}_2$ , is the major constituent of rock-forming minerals in magmatic and metamorphic rocks; it accounts for ca. 75% of the Earth's crust [391]. It is also an important component of sediments and soils [392–394]. In rocks free silica predominantly occurs as quartz, which owes its important role to the action of water in rock-forming processes on Earth. Quartz makes up 12–14% of the Earth's crust. In silicate bodies that crystallized under dry conditions—moon rocks, and silicate slags, for example—quartz is rare; instead, cristobalite and tridymite crystallize. Micro- and noncrystalline silica minerals are described in [395]. The structural framework of crystalline  $\text{SiO}_2$  phases can incorporate trace element impurities in two ways (Figure 48.24) [396]. The first is the substitution-addition mechanism (Figure 48.24): substitution of  $\text{Si}^{4+}$  by  $\text{Al}^{3+}$  or  $\text{Fe}^{3+}$  and addition of  $\text{M}^+$  and  $\text{M}^{2+}$  at interstices ( $\text{M}^+ = \text{Li}^+, \text{Na}^+$ ;  $\text{M}^{2+} = \text{Mg}^{2+}, \text{Ca}^{2+}$ ).

The second is the formation of hydrolytic or alkaline nonbridging oxygens (“Trennstellen”) in the framework. Incorporation of alkali metal and aluminum ions in stoichiometric proportions leads to stuffed derivatives [396], e.g.:

| Structure type:     | high quartz                               | high cristobalite                          | high tridymite                          |
|---------------------|---|--|---|
| Stuffed derivative: | eucryptite<br>$\text{Li}(\text{AlSiO}_4)$ | carnegieite<br>$\text{Na}(\text{AlSiO}_4)$ | kalsilite<br>$\text{K}(\text{AlSiO}_4)$ |

Quartz has a very high geochemical purity, the dissolved trace elements rarely exceeding 100 ppm [395, 397, 398]. Water, however, can be incorporated in concentrations from hundreds to several thousands ppm (Figure 48.25). The transitions from structural incorporation to microstructural inclusion are fluent [399]. Sil-

ica has a strong affinity for water. At elevated temperatures and pressures water migrates rapidly through the structural framework, splitting Si–O–Si bonds and forming silanol groups. This mechanism of hydrolytic weakening activates reconstructive transformations, recrystallization, plastic deformation, and solid-state flow of quartz [400]. Traces of alkali metal oxides act as efficient transformation activators by forming alkaline Trennstellen (Figure 48.24) [401].

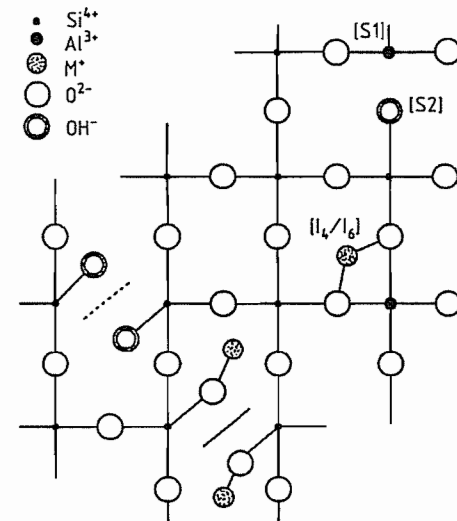

Figure 48.24: Two-dimensional scheme of chemical points defects in  $\text{SiO}_{4/2}$  frameworks. — hydrolytic, — alkaline nonbridging oxygen (Trennstellen); [S] substitutional, [I] interstitial defects.

Apart from stishovite, which contains six coordinate silicon (Figure 48.26B), and silica W, with a tetrahedra-chain structure, the known crystalline silica phases are three-dimensionally linked, ordered frameworks of tetrahedra (Figure 48.26A) sharing all four corners, while the noncrystalline phases are random networks or clusters of all-corner sharing  $\text{SiO}_{4/2}$  tetrahedra, whereby a few tetrahedra may possess some corners with nonbridging oxygen atoms. Four  $sp^3$  hybrid orbitals on Si overlap with the  $2p$  orbitals of oxygen, forming strong  $\sigma$ -bonds [402]. Additional minor bonding contributions arise from overlap of Si  $3d$  orbitals with O  $2p$  orbitals, which partly explains the shortening of Si–O

bond lengths with increasing Si–O–Si bond angle [403].

The approximately 1:1 ionic-to-covalent bond character favors compromise angles between  $180^\circ$  and  $109^\circ$ , averaging ca.  $147^\circ$  [404, 405]. Band theory treatment is given in [406]. In terms of ionic bonding, the radius of  $\text{Si}^{4+}$  in tetrahedral coordination with oxygen ( $r_{\text{O}^{2-}} = 0.127 \text{ nm}$ ) is  $0.034 \text{ nm}$ , and in octahedral coordination,  $0.048 \text{ nm}$ . The mean Si–O bond distance in tetrahedral polymorphs is  $0.161$ – $0.162 \text{ nm}$  [407]. The mean O–O distance is  $0.264 \text{ nm}$  (Figure 48.26A). The short Si–O bond indicates high bond strength ( $452 \text{ kJ/mol}$  in quartz), and in combination with the three-dimensional linking of tetrahedra, it results in high elasticity, melting point (cristobalite  $2000 \text{ K}$ ), activation temperatures for reconstructive transformations ( $1300 \text{ K}$  for quartz cristobalite at ambient pressure), the high transformation temperature of silica glass

( $1300 \text{ K}$ ), and high hardness (quartz: Mohs hardness 7).

The variation in the Si–O–Si bond angles and the almost unrestricted rotation of adjacent tetrahedra around the bridging oxygen atom (Figure 48.26D) accounts for the topological and displacive variability of silica frameworks, the stacking polytypism of cristobalite–tridymite, complex growth and transformation twinning, and the tendency for glass formation. Generally, the favorable trans configuration of adjacent tetrahedra is adopted in the frameworks (Figure 48.26C). Rare exceptions with *cis* and *trans* configurations are the tridymites [401] and coesite [410]. In the trans configuration, the tetrahedra are nearly ideal, whereas the unfavorable *cis* configuration causes distortion of the tetrahedra in the tridymites [411] and is responsible for unusually high Debye–Waller temperature factors of the bridging oxygen atoms in coesite [412].

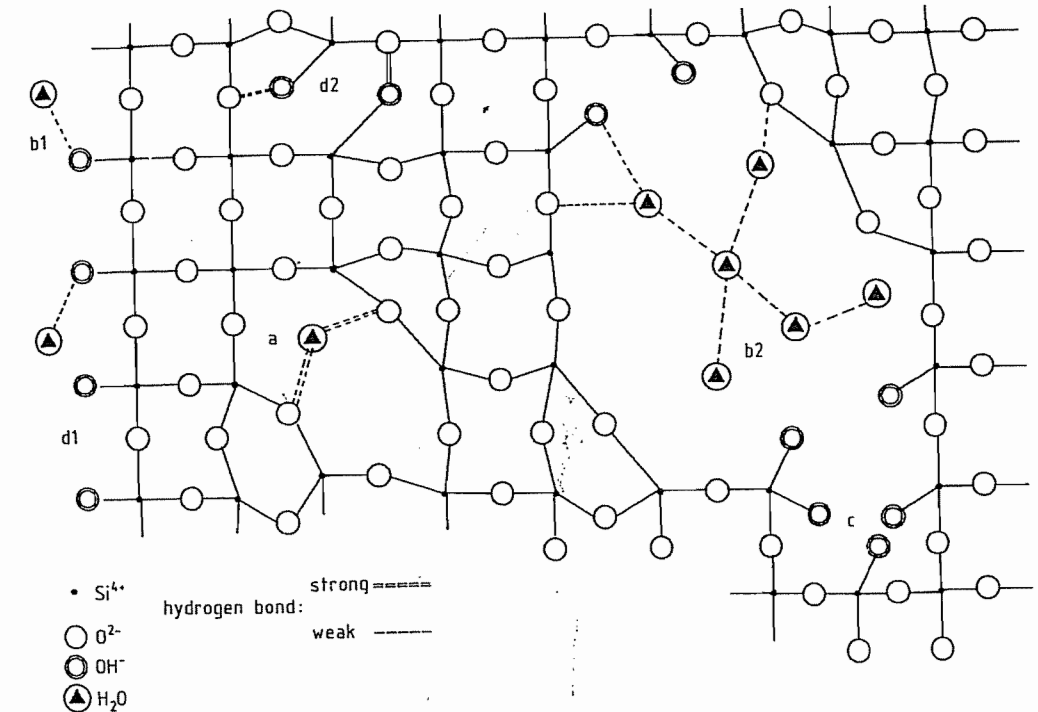

Figure 48.25: Two-dimensional scheme of water in and on the surface of quartz, as revealed by IR spectroscopy [408, 409]: a)  $\text{H}_2\text{O}$  strongly bonded in framework; b1)  $\text{H}_2\text{O}$  at outer surfaces; b2)  $\text{H}_2\text{O}$  clusters in framework (“freezeable water”); c) substitution of  $(\text{SiO}_4)$  by  $(\text{OH})_4$ ; d1) surface silanol groups; d2) Trennstellen silanol groups.

Table 48.8: The crystalline silica minerals.

| Mineral   | Space group   | Cell dimensions, nm |        |                   | Crystal dimensions <sup>a</sup> | Density, g/cm <sup>3</sup> | Refractive indices <sup>b</sup>   |        |        | Optical character | Displacive transformation temperature <sup>c</sup> , K |
|---|---|---------------------|--------|-------------------|---------------------------------|----------------------------|-----------------------------------|--------|--------|-------------------|--|
|   |   | a                   | b      | c                 |                                 |                            | $\alpha$ , $\beta$ , $\gamma$ , ° | $n_x$  | $n_y$  |                   |  |
| <b>Mineral phases</b>                                       |   |                     |        |                   |                                 |                            |                                   |        |        |                   |  |
| Stishovite  | P4 <sub>2</sub> /mm                                       | 0.4177              | 0.2666 | 2                 | ca. 4.3                         | 1.80                       | 1.83                              | 1.85   | 1.83   | 1.85              | +  |
| Coesite   | C2/c  | 0.7135              | 1.2396 | 0.7174            | 120.34                          | 2                          | ca. 2.9                           | 1.594  | 1.596  | 1.599             | +  |
| Low quartz  | P3 <sub>2</sub> 1 R <sup>d</sup><br>P3 <sub>2</sub> 1 L   | 0.4913              | 0.5405 | 120               | 1                               | 2.65                       | 1.5442                            | 1.5533 | 1.5533 | +                 | 846  |
| High quartz (at 600 °C)                                     | P6 <sub>2</sub> 2 R <sup>d</sup><br>P6 <sub>2</sub> 2 L   | 0.45                | 0.5    | 120               |                                 |                            |                                   |        |        |                   | 846  |
| Moganite  | I12/a1 <sup>e</sup><br>C12/c1                             | 0.8758              | 0.4876 | 1.0715            | 90.1                            | 3                          | ca. 2.5                           | 1.52   | 1.53   |                   |  |
| Low cristobalite <sup>f</sup> L-C <sub>0</sub>              | P4 <sub>2</sub> 12 R <sup>d</sup><br>P4 <sub>2</sub> 12 L | 0.4978              | 0.6948 | 1, 2 <sup>g</sup> | 2.33                            | 1.484                      | 1.487                             | 1.487  | 1.487  | -                 | 540 <sup>h</sup>                                       |
| High cristobalite <sup>f</sup> H-C <sub>0</sub>             | Fd3m <sup>i</sup>   | 0.7132              |        | 1, 2              |                                 |                            |                                   |        |        |                   | 540 <sup>h</sup>                                       |
| Low cristobalite <sup>f</sup> L-C <sub>p</sub>              |   | 0.498               | 0.695  | 1, 2              | ca. 2.33                        | 1.485                      |                                   |        |        |                   |  |
| High cristobalite <sup>f</sup> H-C <sub>p</sub>             |   | 0.713               |        | 1, 2              |                                 |                            |                                   |        |        |                   |  |
| Low 1 tridymite <sup>f</sup> L1-T <sub>0</sub>              | Cc  | 0.4991              | 2.5832 | 1.8495            | 117.75                          | 1, 2 <sup>g</sup>          | 2.27                              | 1.47   | 1.48   | +                 | 380  |
| Low 3 tridymite <sup>f</sup> L3-T <sub>0</sub>              | C1  | 0.5008              | 0.8600 | 0.8217            | 91.51                           | 1, 2 <sup>g</sup>          | 2.26                              |        |        |                   | 340  |
| High 5 tridymite <sup>f</sup> (at 95 °C) H5-T <sub>0</sub>  | orthorhombic  | 0.9959              | 1.7440 | 8.179             |                                 |                            | 2.24                              |        |        |                   | ca. 340  |
| High 4 tridymite <sup>f</sup> (at 155 °C) H4-T <sub>0</sub> | P2 <sub>1</sub> 2 <sub>1</sub> 2 <sub>1</sub>             | 0.4986              | 2.6171 | 0.8196            | 2.24                            |                            |                                   |        |        |                   | 380  |
| High 3 tridymite <sup>f</sup> (at 170 °C) H3-T <sub>0</sub> | monoclinic  | 0.5008              | 0.8748 | 0.8212            | 90.28                           |                            |                                   |        |        |                   | ca. 380  |
| High 2 tridymite <sup>f</sup> (at 220 °C) H2-T <sub>0</sub> | C222 <sub>1</sub>   | 0.5024              | 0.8757 | 0.8213            | 2.21                            |                            |                                   |        |        |                   | ca. 430  |
| High 1 tridymite <sup>f</sup> (at 420 °C) H1-T <sub>0</sub> | P6 <sub>3</sub> /mmc                                      | 0.5047              | 0.8262 |                   | 2.19                            |                            |                                   |        |        |                   | ca. 430  |
| Low 2-tridymite <sup>f</sup> L2-T <sub>0</sub>              | F1  | 0.9933              | 1.7217 | 8.1865            | 1                               | ca. 2.28                   | 1.48                              |        |        |                   | ca. 490  |
| High 1 tridymite <sup>f</sup> H1-T <sub>0</sub>             |   |                     |        |                   |                                 |                            |                                   |        |        |                   | 690  |
| Melanophlogite <sup>n</sup>                                 | Pm3n  | 1.3436              |        |                   | ca. 2.0                         | 1.47                       |                                   |        |        |                   | 690  |

| Mineral                  | Space group   | Cell dimensions, nm |       |       | Crystal dimensions <sup>a</sup> | Density, g/cm <sup>3</sup> | Refractive indices <sup>b</sup>   |       |       | Optical character | Displacive transformation temperature <sup>c</sup> , K |
|--------------------------|---|---------------------|-------|-------|---------------------------------|----------------------------|-----------------------------------|-------|-------|-------------------|--|
|                          |   | a                   | b     | c     |                                 |                            | $\alpha$ , $\beta$ , $\gamma$ , ° | $n_x$ | $n_y$ |                   |  |
| <b>Nonmineral phases</b> |   |                     |       |       |                                 |                            |                                   |       |       |                   |  |
| Keatite                  | P4 <sub>2</sub> 12 R <sup>d</sup><br>P4 <sub>2</sub> 12 L | 0.746               | 0.858 | 2     | ca. 2.5                         | ca. 1.52                   | ca. 1.51                          |       |       |                   | -  |
| Silica W                 | Icma  | 0.836               | 0.472 | 0.516 | 2 fibers                        | ca. 1.97                   |                                   |       |       |                   |  |

- <sup>a</sup> 1: macroscopic, 2: microscopic, 3: submicroscopic.  
<sup>b</sup> Values in each column: optically biaxial; values in left and right column: uniaxial; values in middle column: mean value.  
<sup>c</sup> Two values: intermediate high-modification.  
<sup>d</sup> Handfulness of enantiomorphic groups: R = right, L = left.  
<sup>e</sup> J-Setting for comparison with quartz structure.  
<sup>f</sup> Stacking ordered cristobalite: C<sub>0</sub>, tridymite, T<sub>0</sub>.  
<sup>g</sup> High-low transformation causes polysynthetic microtwinning.  
<sup>h</sup> Transformation hysteresis low-high ca. 10 K, high-low ca. 20 K.  
<sup>i</sup> At 570 K.  
<sup>j</sup> Average structure with six fold twinned domains.  
<sup>k</sup> Stacking disordered cristobalite: C<sub>p</sub>; tridymite: T<sub>p</sub>.  
<sup>l</sup> "Tridymite S (table)" or "metacritic tridymite"; redundant terms.  
<sup>m</sup> "Tridymite M (easiable)" or "terrestrial tridymite"; redundant terms.  
<sup>n</sup> With guest molecules.

### 48.7.1.2 Crystalline Silica Phases

The crystalline silica minerals are listed in Tables 48.8 and 48.9. Table 48.8 also lists the two known nonmineral crystalline phases.

#### Crystalline Silica Minerals

The  $p$ - $T$  diagram of silica, with stishovite, coesite, quartz, and cristobalite, is shown in Figure 48.27 [413]. The existence field of tridymite is too small to be shown here.

**Stishovite** crystallizes in the rutile structure with [SiO<sub>4</sub>] octahedra sharing two opposite edges and two corners [414, 415], resulting in very close packing of the oxygen atoms. At ambient pressure it transforms at  $\geq 800$  K rapidly into noncrystalline silica. Stishovite is almost insoluble in hydrofluoric acid; however, its solubility in water under ambient conditions is comparable to that of silica glass.

**Coesite** has its own structure type. Four-membered rings of tetrahedra are interlinked by Si<sub>2</sub>O<sub>7</sub> groups, with the tetrahedra in the *cis* configuration and an apparent Si-O-Si angle of 180° at the bridging oxygen, which, however, appears to be the average structure of domains with more equilibrated tetrahedral configurations [410, 412]. Coesite is metastable, but at ambient pressure it persists up to ca. 1300 K. It is much less soluble in hydrofluoric acid than quartz, but the solubility in water under ambient conditions is similar to that of quartz. The occurrence of microcrystalline oxide precipitates with coesite-like structure in semiconductor silicon is still being discussed [416]. Stishovite and coesite are rare in nature and can be synthesized only in milligram quantities.

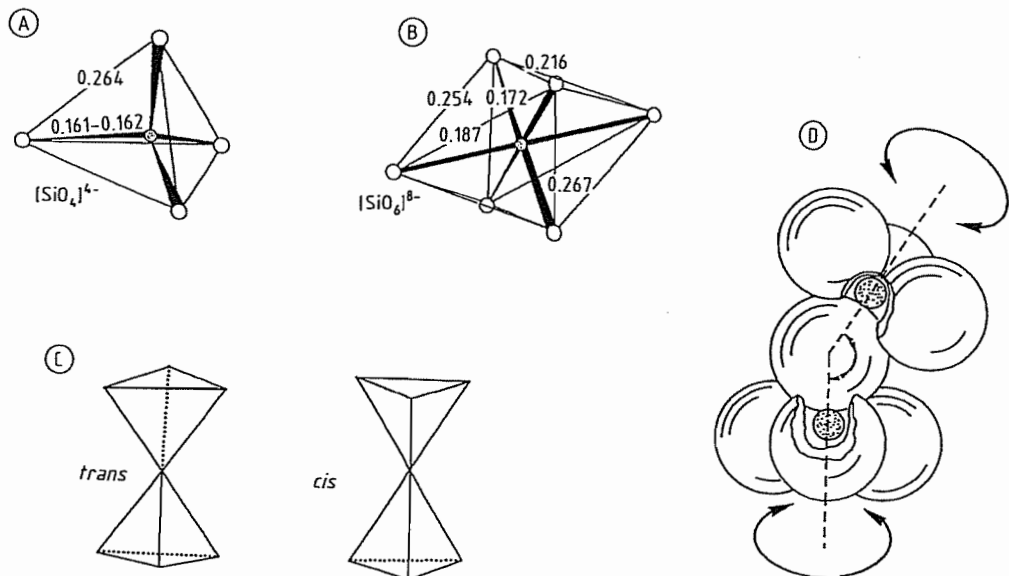

Figure 48.26: Details of silica crystal structures (see text for explanation).

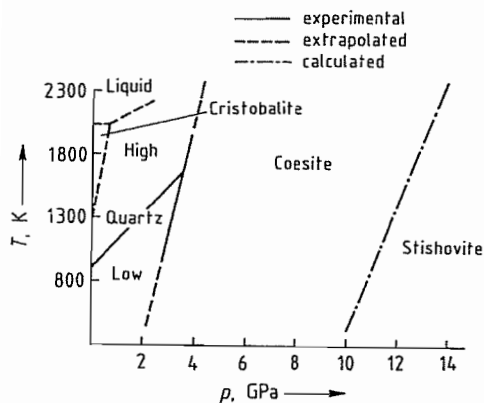

Figure 48.27: *p-T* diagram of  $\text{SiO}_2$  system [413]. The borderline of tridymite to high quartz and high cristobalite runs along the ordinate from ca. 1200 to ca. 1800 K.

**Quartz** is the stable phase under ambient conditions. Due to the sluggish transformation the boundary to the coesite field at low pressures and temperatures can only be extrapolated. The same is true for the quartz–cristobalite boundary. The most important structural features are helices composed of tetrahedra along the *c*-axis. The helices have a repeat distance of 3 tetrahedra (T) (3T chain). The winding of the helices can be left- or right-handed, which results in the enantiomorphism of quartz crys-

tals [417, 418]. Six helices envelope structural channels with four-fold  $[I_4]$  and six-fold  $[I_6]$  oxygen-coordinated interstitial sites which alternate along the *c*-axis. Polarity along the *a*-axes accounts for the piezoelectricity of low quartz and its use in oscillator and voltage-pressure transducers. The low sensitivity, however, requires high-voltage amplification [419]. The low specific free surface energy of the rhombohedral faces  $\{10\bar{1}1\}$  results in distinct cleavage [397]. The low thermal conductivity ( $\lambda_{11} = 6.2 \text{ W m}^{-1}\text{K}^{-1}$ ,  $\lambda_{33} = 10.4 \text{ W m}^{-1}\text{K}^{-1}$ ) and high thermal expansion ( $\alpha_{11} = 13.3 \times 10^{-6} \text{ K}^{-1}$ ,  $\alpha_{33} = 7.1 \times 10^{-6} \text{ K}^{-1}$ ) produce low thermal shock resistance, which can be exploited for crushing coarse quartz. Standard values of important properties are collected in [420], and relationships between structure and properties are given in [419].

The displacive transformation of low quartz to high quartz involves cooperative rotatory dislocation of the tetrahedra leaving the Si–O bonding topology unaffected. The transformation is rapid, reversible, and occurs without hysteresis. Starting with low quartz, the rotatory vibrational disorder increases continuously with temperature [418, 421].

Randomization reaches a maximum at the transformation temperature, which is illustrated by thermal expansion as a function of temperature (Figure 48.28). The difference in

specific volume between 300 and 850 K is 4%. The last jump between 825 and 850 K contributes about 1% [422]. The shape of the specific heat  $C_p$  curve is of the lambda type.

Table 48.9: The microcrystalline mineral species of quartz and of cristobalite–tridymite (opals).

| Property <sup>a</sup>              | Microcrystalline quartz species <sup>b</sup> |   |   |  |                   |
|------------------------------------|--|---|---|--|-------------------|
|                                    | Microquartz MQ                               | Chalcedony $\text{CH}_{\text{LF}}$                                      |   | Quartzine $\text{CH}_{\text{LS}}$                              |                   |
|                                    |  | CH-W <sub>LF</sub>  | CH-H <sub>LF</sub>  |  |                   |
| <b>PLM</b>                         |  |   |   |  |                   |
| Mean refractive index              | ca. 1.54–1.55                                | ca. 1.533–1.543   |   | ca. 1.542  |                   |
| Microstructure                     | granular, undulatory extinction              | parabolic fiber bundles striations                                      | radiating spherulites striations  | parabolic fiber bundles (plait pattern) spherulites striations |                   |
|                                    |  |   |   |  |                   |
|                                    |  |   | ..... opal — CT matrix  |  |                   |
| Mean crystallite size (PLM, X-ray) | < ca. 20 $\mu\text{m}$                       | ca. 50–350 nm   | ca. 100–200 nm  | ca. 100–200 nm   |                   |
| Texture (PLM, SEM)                 |  | parallel fibrous  | parallel fibrous  | plaited fibers   |                   |
| Texture (X-ray diffraction)        |  | fiber axis: $\langle 11.0 \rangle$ , $\langle \bar{1}\bar{1}.0 \rangle$ | fiber axis: $\langle 11.0 \rangle$ , $\langle \bar{1}\bar{1}.0 \rangle$ | fiber axis: $\langle 00.1 \rangle$                             |                   |
| <b>TEM</b>                         |  | polysynthetic twinning of R/L quartz lamellæ                            |   | polysynthetic twinning of R/L quartz lamellæ                   |                   |
|                                    |  | wrinkle-banding   |   |  |                   |
|                                    |  | Microcrystalline opals <sup>b</sup>                                     |   |  |                   |
|                                    |  | Opal-C O-C  |   | Opal-CT O-CT   |                   |
|                                    |  | O-C <sub>LF</sub>   | O-C <sub>M</sub>  | O-CT <sub>LS</sub>   | O-CT <sub>M</sub> |
| <b>PLM</b>                         |  |   |   |  |                   |
| With crossed polarizers            | birefringent                                 | almost isotropic  | birefringent fibrous-parabolic  | almost isotropic   |                   |
| Mean refractive index              | ca. 1.46                                     | ca. 1.45  | 1.45–1.46   | 1.43–1.45  |                   |
| Microstructure                     |  |   |   |  |                   |
| <b>SEM</b>                         | parallel-plate after 111                     | tangled-platey  | parabolic fiber bundles   | lepidospheric tangled-platey                                   |                   |
| <b>TEM</b>                         |  | massy   | fiber axis: $\langle 101 \rangle$ or $\langle \bar{1}10 \rangle$        | tangled-fibrous platelets intergrown at angles of ca. 70°      |                   |

<sup>a</sup> PLM: polarizing light microscope; SEM: scanning electron microscope; TEM: transmission electron microscope.  
<sup>b</sup> LF: optical character of fiber elongation negative; LS: optical character of fiber elongation positive; M: massy, tangled; W: wall-banded; H: horizontally banded.

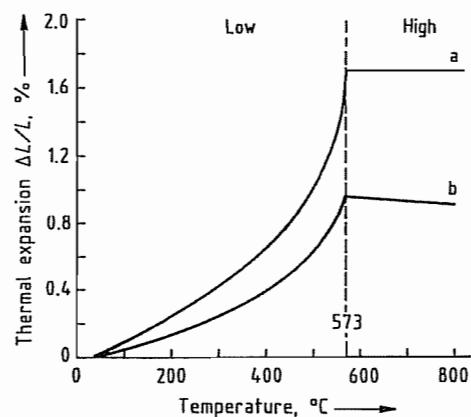

Figure 48.28: Thermal expansion of quartz: a) Parallel to *a*-axis; b) Parallel to *c*-axis.

Abnormal properties, such as optical biaxial character are due to inequivalent substitution of the three equivalent Si atoms of the structure by traces of Al or Fe during growth [423–425].

After passing through a region of retrograde solubility, under hydrothermal conditions the solubility of quartz in water increases strongly with pressure and temperature (Figures 48.29, 48.33) [426, 427]. Only above 400 K are equilibrium solubilities determinable at ambient pressure. At ambient temperature the solubility is ca. 6 ppm SiO<sub>2</sub> [428]. Quartz solubility plays an important role in the exploitation of geothermal energy (silica scaling in pipes and valves) [429]. Water in quartz (Figure 48.25) is highly mobile. The diffusion constant in the temperature range 625–1300 K is  $D \approx 10^{-12} e^{-9518/T}$  [430]. Fluid inclusions found in nature are mainly H<sub>2</sub>O, CO<sub>2</sub>, and CH<sub>4</sub>. Under ambient conditions NaCl may be partly precipitated from the saline fluid [431]. The diffusion coefficient of Na from 575 to 845 K parallel to the *c*-axis is  $D_{||c} = 0.68 e^{-84/RT}$ , and perpendicular to the *c*-axis  $D_{\perp c} = 400 e^{-113.9/RT}$  [432]. The diffusion depends strongly on the type and concentration of structural defects [433]. Perpendicular to the *c*-axis quartz is an insulator. However, alkali metal ions incorporated or deliberately introduced during growth in the *c*-direction result in electrolytic conduction [419].

**Chalcedony and Quartzine.** The microcrystalline quartz species chalcedony and quartzine (Table 48.9) [395] have dense microstructures of fibers composed of submicroscopic right-(R-) or left-(L-) handed quartz lamellæ. Chalcedony occurs in agate nodules in masses of several kilograms. High hardness combined with high toughness and high purity (< 1% nonvolatiles, 0.5–2% H<sub>2</sub>O) leads to high demand as an industrial mineral.

**Quartz whiskers,** in contrast to chalcedony and quartzine, are isolated single crystal fibers of ca. 1 μm diameter. They form by hydrothermal transport of silica with water [434].

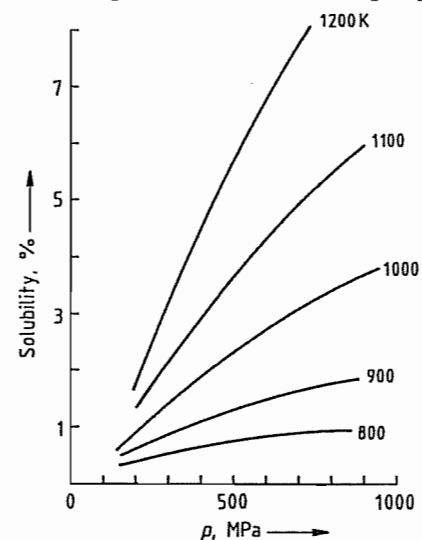

Figure 48.29: Hydrothermal solubility of quartz in water [426, 427] (isotherms in the high-pressure range).

**Moganite.** The crystal structure of moganite, a very rare microcrystalline silica mineral [435], consists of systematic twinning of one R- and one L-quartz {10T1} lattice slice per unit cell [436].

**Cristobalite** is the low-pressure, high-temperature modification of silica (Figure 48.27). The structure of high cristobalite is a derivative of the zinc blende type, with Si occupying the Zn and S positions. The framework consists of SiO<sub>4/2</sub> tetrahedra in *trans*-configuration, forming sheets of 6T rings with the tetrahedra in up-and-down positions (Figure

48.30). The sheets are in parallel orientation, stacked in a three-sheet sequence along the ⟨111⟩ directions. The structure has large interstitial cages. The apparently linear Si–O–Si bonds in high cristobalite are due to an average structure with six-fold domains; a true bond angle of 147° has been calculated [437]. The displacive high cristobalite–low cristobalite transformation is rapid, reversible, and cannot be frozen, though it shows a hysteresis of ca. 20 K. The sudden increase in specific volume on high low transformation is 4%, leading to characteristic “fish scale” microcracking. These scales are rectangular if the cristobalite is structurally ordered and become rounded with increasing stacking disorder [438]. Under nearly all conditions, the kinetics [439] prevent the growth of macrocrystals. Instead, repeated nucleation and dendrites are common growth features. The lack of suitable cristobalite macrocrystals limits the precise determination of properties and the extent of impurity incorporation. Coarse, refractory grade cristobalite crystals incorporate < 1% impurities [440]; natural cristobalite crystals, with a more complex microstructure, have higher contents of inclusions [441].

**Tridymite** is unstable to high pressures at elevated temperature. At ambient pressure it forms at 1200–1800 K; however, traces of foreign ions—preferably the alkali metals—are necessary. Formation is also favored by hydrothermal conditions [442]. Tridymite crystallization according to the nucleation-growth process [401] starts with cristobalite nuclei. The growth kinetics favor the formation of large tabular crystals [439]. The crystal structure is a derivative of the hexagonal wurtzite type with Si occupying the Zn and S positions. Sheets of 6T rings are stacked in antiparallel orientation to give a two-sheet sequence (Figure 48.30). With respect to bonding requirements the structure is much less balanced than that of cristobalite. As a consequence tridymite undergoes very complex high–low transformations. Trace ele-

ments are incorporated substitutionally and in open structural channels parallel to the *c*-axis [441]. In refractory grade crystals, trace element concentration is < 1% [443].

**Cristobalite–Tridymite Stacking Polytypism.** The close structural relationships enable stacking faults to occur during growth or reconstructive transformation. Intergrowth of tetrahedra sheets with cristobalitic or tridymitic stacking sequences and the transformation of cristobalite into tridymite and vice versa go off with mutual orientation [444]. Due to the nucleation-growth mechanism [401] and stacking polytypism several tridymite modifications and cristobalite may be intergrown in a single tridymite crystal [445]. Stacking disorder changes all properties, including temperature and heat of displacive transformation, as well as thermal expansion and X-ray diffraction, which are used for quantitative phase determination [446]. Unawareness of this fact led repeatedly to speculation about a “transition phase” occurring during quartz cristobalite–tridymite transformations [447, 448], which, however, does not exist. In any case it is necessary to discriminate between ordered and stacking disordered cristobalite (C<sub>O</sub> and C<sub>D</sub>) and tridymite (T<sub>O</sub> and T<sub>D</sub>). The terms tridymite S or meteoritic tridymite, and tridymite M or terrestrial tridymite are redundant synonyms for T<sub>O</sub> and T<sub>D</sub> [411].

**Melanophlogite,** a very rare mineral with noteworthy occurrences known only in Agri-gento and Livorno, Italy [449, 450] is treated in Section 48.7.8.3.

### Crystalline Nonmineral Silica Phases

Only two crystalline nonmineral silica phases are known, both of which do not occur in nature due to their instability (Table 48.8).

**Keatite** is synthesized as metastable microfibrillar parabolic bundles from noncrystalline silica under weakly alkaline hydrothermal conditions [451].



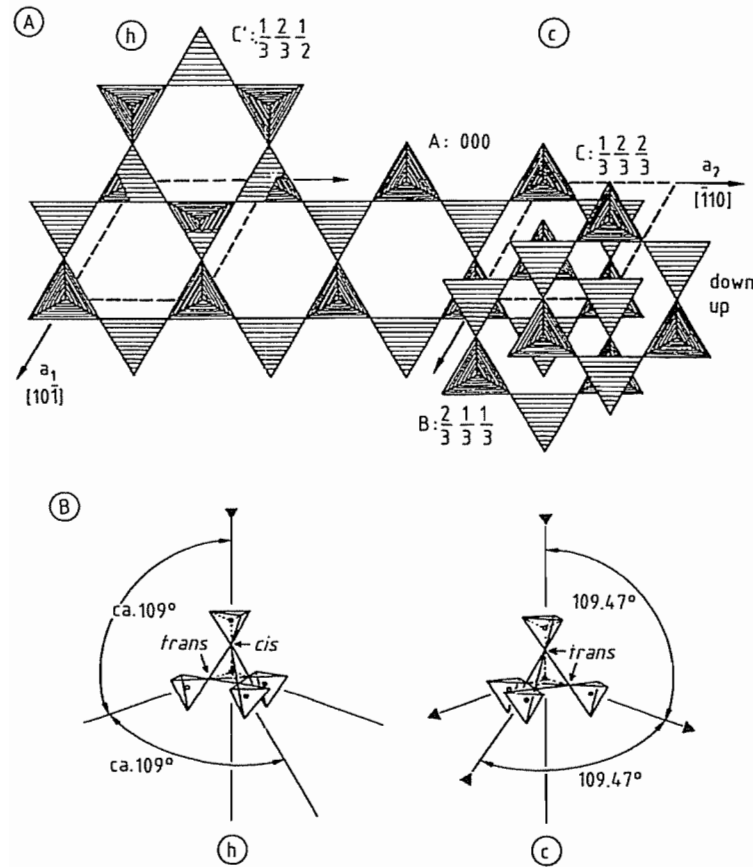

**Figure 48.30:** A) Stacking principles of idealized six-membered up and down ring tetrahedra sheets. c: Cristobalite, A, B, C sheets parallel; h: Tridymite, A and C' sheets in antiparallel position. B) Tetrahedra configurations in the framework. c: Cristobalite—all *trans*; h: Tridymite— $\frac{3}{4}$  *trans*,  $\frac{1}{4}$  *cis*.

**Table 48.10:** The noncrystalline silica minerals.

| Mineral or phase  | Species                      | Microstructure (PLM/SEM)  | Abbreviation <sup>a</sup> | Density, g/cm <sup>3</sup> | Refractive index |
|---|------------------------------|---|---------------------------|----------------------------|------------------|
| Opal-A (noncrystalline silica with characteristic amounts of water) | opal-A <sub>G</sub>          |   | O-A <sub>G</sub>          | variable                   | ca. 1.45–1.46    |
|   | precious opal-A <sub>G</sub> | close packing of homometric SiO <sub>2</sub> ·nH <sub>2</sub> O spheres       | O-A <sub>G</sub> -prec.   |                            |                  |
|   | potch opal-A <sub>G</sub>    | irregular packing of heterometric SiO <sub>2</sub> ·nH <sub>2</sub> O spheres | O-A <sub>G</sub> -potch   |                            |                  |
|   | opal-A <sub>N</sub>          | botryoidal with striations  | O-A <sub>N</sub>          |                            |                  |
| Lechâtlierite (silica glass, almost free of water)                  | hyalite                      | bubbles from degassing  |                           | ca. 2.1–2.2                | ca. 1.45–1.46    |
|   | silica-fulgurite             | relics of quartz grains cristobalite  |                           | ca. 2.2                    | ca. 1.458        |
|   | meteoritic silica glass      | pores schlieren meteoritic detritus and reaction products                     | LEC                       |                            |                  |

<sup>a</sup> A: noncrystalline; G: gel structure; N: network structure.

The tetrahedral framework of the keatite structure [452] contains 4T helices along the *c*-axis. 3T single chains [453] run parallel to the *a*-axes. The structure is not yet well refined; however, stuffed derivatives MA<sub>3</sub>Si<sub>2</sub>O<sub>6</sub> (M = H<sup>+</sup>, Li<sup>+</sup>, Na<sup>+</sup>, K<sup>+</sup>) have been structurally well characterized [454].

**Silica W** [455] forms above ca. 1500 K in the decomposition and vapor transport reaction

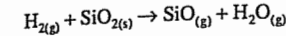

as metastable fibrous woolly aggregates. The crystal structure is isotypic with SiS<sub>2</sub>. Infinite chains of edge-sharing tetrahedra run parallel to one another and are held together by weak interatomic forces. At ambient temperature, this very unstable configuration collapses immediately on coming into contact with traces of water. Tempering under the formation conditions produces cristobalite [455].

The substance known as SiO<sub>2</sub>-X, is an alkali metal silicate hydrate with the approximate formula MSi<sub>11</sub>O<sub>20.5</sub>·3H<sub>2</sub>O (M = K, Rb, Cs) [456].

#### 48.7.1.3 Noncrystalline Silica Minerals

Noncrystalline silica minerals are listed in Table 48.10.

The lack of structural order and therefore of distinct stoichiometry makes the boundary between silica glass and silicate glasses fuzzy. For natural silica glass it can be arbitrarily drawn at ca. 3 mol % of nonsilica components.

**Lechâtlierites**, which originate from silica melts formed by meteoritic impacts or lightning strikes on quartz sand or quartz rocks, are very rare [395, 397].

**Opals-A<sub>G</sub>** are formed by flocculation of high-purity SiO<sub>2</sub>·nH<sub>2</sub>O spheres of ca. 100–500 nm diameter when colloidal silica percolates through water-permeable clays or metamorphosed volcanic rocks. The water is filtered and the spheres aggregate, with closest packing if they are homodisperse, or irregular packing if they are heterodisperse. Cubic close packing (ccp) is preferred because of its low

free surface energy. The ordered packings produce Bragg diffraction of visible light, while the disordered packings give rise only to Rayleigh scattering [457]. Biogenic opal-A<sub>G</sub> is formed from skeletal silica remains of plankton. The water content of opals-A<sub>G</sub> varies in the range ca. 58% with ca. 4–7% molecular water [395, 408]

**Opal-A<sub>N</sub>** is a water-containing silica glass, formed by quenching of aqueous fluid silica solutions [395]. The opals-A are characterized by their microstructure and water content [408]. Opal-A<sub>N</sub> with a continuous three-dimensional random tetrahedral network gives no small-angle X-ray scattering. Opal-A<sub>G</sub> which consists of particle aggregates and water-filled microporosity [408] with discontinuous electron density, produces distinct small-angle X-ray scattering [458]. Opal-A<sub>N</sub> contains ca. 3.5% water with 1.5% as silanol group water in the network and on the surfaces. The remainder is molecular water included in pores.

#### 48.7.1.4 Silica Rocks

The classification of silica rocks is given in Table 48.11 [393, 459, 460]. Many special, trade, and trivial names exist, with varying meanings and often imprecise definitions. For example, “tripoli” is a friable porcellanite, and “ganister” a quartz sandstone cemented by chalcedony or opal-CT (cf. Table 48.11). Industrial silica rocks are treated in [461, 462]. Agates are siliceous fillings of vesicles and veins in volcanic rocks, consisting mainly of chalcedony with intergrown and interstratified granular microquartz, quartzine, opal-C, opal-CT, and coarse quartz [464, 465].

#### 48.7.1.5 Crystalline Silica Products

Here, only silica products that are produced by crystallization from mobile mother phases or by transformation in the solid state are discussed.

Table 48.11: Silica rocks (> 90% SiO<sub>2</sub>).

| Classification           | Name           | Main constituent silica minerals; microstructure   | Special, trade and trivial names (selection)                         |
|--------------------------|----------------|--|--|
| Metamorphic              | quartzite      | recrystallized quartz grains   | crystalline quartzite, diamond quartzite, felsquarzit, taunusquarzit |
| Sedimentary detrital     | quartz arenite | detrital quartz grains cemented by <ul style="list-style-type: none"> <li>• direct contact</li> <li>• authigenic outgrowth</li> <li>• chalcedony, opal-CT</li> </ul> | quartz sandstone   |
|                          |                |  | orthoquartzite, ganister, silcrete, zementquarzit, findlingsquarzit  |
| Sedimentary non-detrital | diatomite      | opal-A, detritic quartz; coherent diatom accumulations   | kieselguhr [394]   |
|                          | porcellanite   | opal-CT; microporous (up to 50 vol %) dense and rather strong rock with conchoidal fracture; grades into chert   |  |
|                          | radiolarite    | opal-A, opal-CT, chalcedony; coherent, friable   | tripoli [463]  |
|                          | chert          | chalcedony, microquartz; nonporous tough rock with conchoidal fracture, containing scattered iron oxides, clay, and carbonate minerals                               | hornstein, jasper, novaculite [463]                                  |
|                          | nodular chert  | from chalk or limestone  | flint <sup>a</sup> , silix, feuerstein                               |
|                          | bedded chert   | interbedding with mudstone or shale  | phtanite, silica slate, radiolarite, lydite, kieselschiefer          |
| Volcanic                 | geyserite      | opal-A <sub>G</sub> , opal-CT; friable, porous   |  |

<sup>a</sup> In the porcelain and earthenware industry in Europe, "flint" is used for ground flint, and in the United States, for ground quartz sand as well.

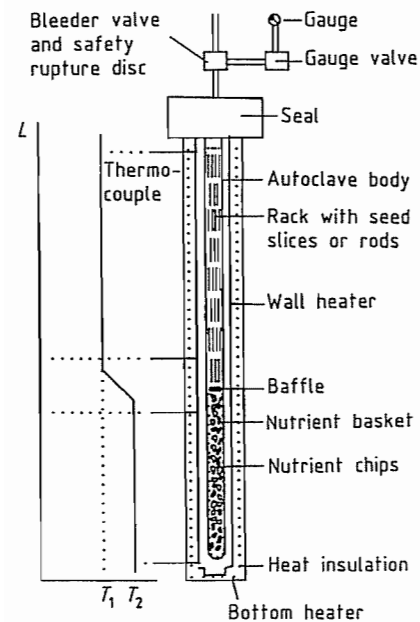

Figure 48.31: Autoclave for quartz single crystal bar growth.

In contrast to the many noncrystalline silica products, crystalline silica products are limited to hydrothermal cultured quartz crystals and thermochemically produced silica refractories.

Cultured quartz is of major economic importance and its use is growing rapidly. In contrast, the development of silica refractories has stagnated. They are used in certain high-temperature processes, and are generally produced batchwise when required, for example, when a new coke oven battery is installed, which can then be operated for up to 20 years with negligible silica consumption.

### Cultured Quartz Single Crystals

The growth of quartz single crystals is carried out hydrothermally in sealed steel autoclaves with constant temperature difference and density-driven convection [466] (Figure 48.31). Hydrothermal syntheses are defined as growth or reaction at high pressure and tem-

perature in aqueous solution, both in the sub- and supercritical state [467].

Natural quartz [468] is fractionated into chips of controlled size distribution and surface area. They serve as nutrient and are filled into an iron wire basket which is placed in the lower part of the autoclave. The lower part is separated from the upper part by a baffle of defined opening. Seed slices or rods, cut with defined crystallographic orientation from natural or cultured quartz crystals that are untwinned and have a low content of structural defects, are hung in a rack and placed in the upper part of the autoclave. Preferred seeds are Z plates, cut parallel to {0001}, and Y rods, cut parallel to {1120} and {0001} and perpendicular to one of the *a*-axes.

Aqueous growth solutions with different mineralizers (mainly 0.5–2.0 M NaOH or Na<sub>2</sub>CO<sub>3</sub> and additives such as Li<sub>2</sub>O) fill ca. 70–80% of the inner volume of the autoclave. Special syntheses such as growth of amethyst with incorporation of iron require K<sub>2</sub>CO<sub>3</sub> or NH<sub>4</sub>F solutions [469, 470].

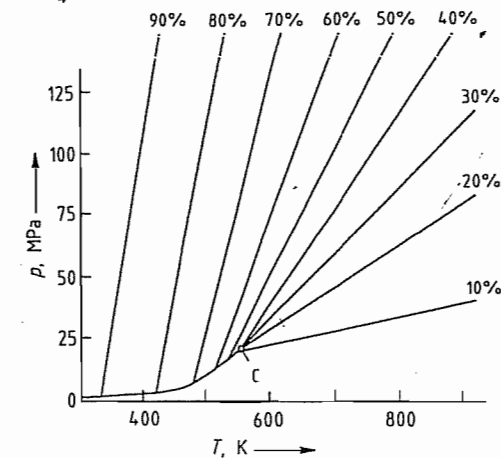

Figure 48.32: *p*-*T* diagram of H<sub>2</sub>O, isochores for various percentages of autoclave filling [471, 472]. C: critical point at 22.04 MPa, 547.4 K.

After sealing, the autoclave is electrically heated to a working temperature of ca. 675 K at the outer wall of the nutrient part (*T*<sub>2</sub>) and ca. 20–40 K less at the seed part (*T*<sub>1</sub>) (Figure 48.31). The actual temperature difference  $\Delta T$  in the reactor is much smaller (5–10 K). With

increasing temperature, according to the percentage of filling, the pressure increases (Figure 48.32). Under working conditions it is ca. 100–150 MPa. A rupture disk in the pressure tubing at the autoclave seal prevents hazardous pressure increase.

During heating and cooling of the autoclave at pressures below ca. 80 MPa the system passes through a region of retrograde SiO<sub>2</sub> solubility. Above 80 MPa the solubility increases with temperature and pressure (Figure 48.33). The mineralizers increase the SiO<sub>2</sub> solubility, e.g., at 673 K and 100 MPa from ca. 0.15% for pure water to about 2–3%; the solubility is approximately proportional to the mineralizer concentration [473]. Concentrations of NaOH or Na<sub>2</sub>CO<sub>3</sub> above 2 mol/L can lead to deposition of water glass at the bottom of the autoclave.

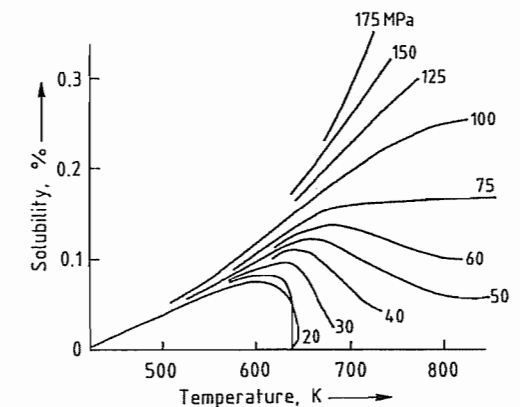

Figure 48.33: Solubility of SiO<sub>2</sub> in H<sub>2</sub>O [473].

In the nutrient section SiO<sub>2</sub> goes into solution. Saturation, however, is not reached because the density of the solution is lower than that of the cooler solution in the seed section, and it therefore rises. Above the baffle it is cooled and becomes supersaturated with SiO<sub>2</sub>, which deposits on the seed, which starts growing. The solution in the seed section has a higher density and sinks through the baffle into the nutrient section where it is heated and becomes subsaturated. It dissolves SiO<sub>2</sub> from the nutrient chips, ascends, and so on in a permanent density-difference driven circulation

until all nutrient is transported to the growing crystals.

The effective nonequilibrium distribution coefficient is defined as

$$k_{\text{eff}} = C_{s,\text{act}}/C_{l,\text{act}}$$

where  $C_{s,\text{act}}$  is the actual trace element concentration in the solid, and  $C_{l,\text{act}}$  the actual trace element concentration in the liquid. For  $k_{\text{eff}} > 1$  the trace element impurities accumulate in the solution [474] and the cultured quartz bars are of higher purity than the nutrient. Doping with special components changes the trace element chemistry. For example, doping with LiF improves the electrical quality of quartz.

Increasing  $p$ ,  $T$ , and  $\Delta T$  increases the rate of  $\text{SiO}_2$  transport and quartz growth. However, the high-temperature strength of the autoclave alloy limits  $p$  and  $T$ , and transition of convection from laminar to turbulent or even cellular flow restricts  $\Delta T$ . Increasing face instability [474] and defect concentrations (channels, inclusions, dislocations) with increasing transport rates are further limiting factors.

The corrosion of the steel autoclave alloy is inhibited by formation of a dense coating of microcrystalline akmite,  $\text{NaFe}^{3+}[\text{Si}_2\text{O}_6]$ , and traces of emeleusite,  $\text{LiNa}_2\text{Fe}^{3+}[\text{Si}_6\text{O}_{15}]$ , on the inner wall. These minerals may also be found as inclusions in the crystal bars.

The duration of growth runs varies between 1 and 4 months, depending on the growth conditions. An autoclave with 250 mm inner diameter and an inner length-to-diameter ratio of 12 gives a yield of ca. 100 kg of quartz bars per month. The loss by removal of seeds from the bars is ca. 20%. Part of the cutting waste is used in the jewelry industry [475]. Growth parameters, which determine yield and quality of cultured quartz, are complexly coupled [476].

Maximum dimensions and yield capacities of autoclaves are summarized in Table 48.12.

Table 48.12: Dimensions and yield capacities of autoclaves for cultured quartz.

|       | Inner diameter, cm | Inner length, m | Inner volume, L | Yield per run, kg |
|-------|--------------------|-----------------|-----------------|-------------------|
| Japan | 65                 | 13              | 4500            | 2000              |
| USA   | 40                 | 4.5             | 560             | 250               |

Worldwide quartz bar production in 1985 was ca. 1760 t (gross), i.e., 1410 t (net) after deduction of seed losses.

The largest production capacities exist in Japan and in the United States. Smaller capacities exist in Europe, Brazil, China, and South Africa. For 1992, growth capacities are estimated at 1400 t in Japan, 2300 t in the western world, 600 t in the CIS, and 300 t in China [475].

Small amounts of colored quartz [477, 478] for jewelry are cultured in the C.I.S. While blue (Co) and light green and yellow (Fe) quartz become colored in the growth process, the Al and Fe color centers for smoky quartz and amethyst must be activated by  $\gamma$ -irradiation after growth. The seeds for the first three color variations are Z-plates, whereas for smoky quartz and amethyst X-plates cut parallel to  $\{01\bar{1}1\}$  are used because of face-specific incorporation requirements of the dopants.

Filter and oscillator quartz must be free of twinning and of low defect concentration. Structurally incorporated impurities are determined by chemical trace analysis. Impurities that produce paramagnetic defects can be detected by electron spin resonance spectroscopy [479]. Dislocations produce diffraction contrast in X-ray topography [480, 481]. Water is determined by IR spectroscopy [482]. Inclusions are recognizable with X-ray diffraction, under the polarizing light microscope (PLM), and can be analyzed with an electron microprobe [483]. Brazil twinning can be seen with PLM, but Dauphine twinning can only be made visible by etching. Both types of twinning can be detected by X-ray topography [484, 485]. The quality of single-crystal quartz for vibrator uses is described by the electromechanical  $Q$ -value. Analogous to an electronic circuit resonating with the same frequency, this dimensionless quality-factor is defined as:

$$Q = \frac{2\pi fL}{R}$$

where  $f$  is resonance frequency,  $L$  inductance, and  $R$  resistance [486].

$Q$  increases with decreasing energy loss due to relaxation and internal friction. The slower the decay of the vibration amplitude after cutting off the excitation, the higher is  $Q$ . A correlation exists between the IR absorptions of the structural OH groups at 3580 and 3410  $\text{cm}^{-1}$  and the vibrational quality of quartz [487]. Therefore, an optical quality value  $a$  is defined that is derived from the absorption coefficients at 3580 and 3410  $\text{cm}^{-1}$  and which is inversely proportional to  $Q$ .

Quartz with high  $Q$  is obtained by slow growth in the  $\{0001\}$ -sector ( $c$ - or  $Z$ -seed growth with  $\text{Na}_2\text{CO}_3$  solutions).

In 1921 CADY described the first oscillator for generation of stable frequencies, cut from a natural quartz single crystal [488]. Today the uses of oscillator quartz are diverse and expanding (Figure 48.34), so that a comprehensive and detailed treatment cannot be given here. Electronic quartz component devices are principally used as filters, oscillators, timers, and sensors. Optical-grade quartz is used as a low-loss light transmitter. Cultured optical-grade quartz retains high transmissivity further into the UV and IR than natural quartz or silica glass. Whereas poly(vinylidene fluoride) layers are competing increasingly with quartz for piezoelectric devices, the importance of quartz as oscillator is unchallenged in applications such as high-sensitivity thermometers, thickness-measurement devices for vapor-deposited layers, in integrated circuits, microprocessors and synthesizers, and in color television, video and other communication systems.

Radiation, for example in space or from uranium or thorium impurities, affects the oscillator frequencies by action on alkali metal impurities. Therefore, quartz is cultured to extreme purity and the alkali metals are removed (swept) electrolytically after growth.

Electronic applications of cultured quartz are treated in [485, 488, 489]. Demand for quartz oscillator devices has increased from ca.  $10^9$  pieces in 1985 to  $1.75 \times 10^9$  in 1989; for 1993, a demand of  $(3-4) \times 10^9$  is estimated. Natural single-crystal quartz is now used only for a few special applications.

Despite the increasing demand, growth capacities are not markedly increasing because of improved cutting techniques, increasing miniaturization of oscillator devices, and the use of photolithographic etching. Quartz tuning forks for wrist watches are mass produced by this technique. Photolithography produces very high accuracies, allows any shape to be etched from large wafers, and lowers production costs.

Costs of cultured quartz in 1990 in \$/kg were [490]:

|                         |      |
|-------------------------|------|
| Y bar, as grown         | 60   |
| Premium Q quartz        | 210  |
| Optical-grade quartz    | 600  |
| Swept, ultrapure quartz | 1600 |

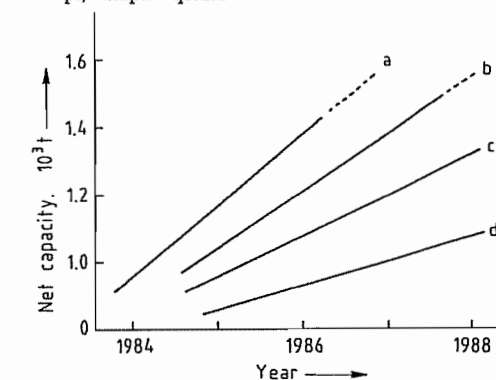

Figure 48.34: Net capacity (after seed removal) and usage of cultured quartz, Western world: a) Net capacity; b) Total usage; c) Oscillator usage; d) Optical usage.

### Refractory Silica

By definition refractory silica must contain  $\geq 93\% \text{SiO}_2$  [491].

**Production.** Silica bricks, containing 96–98%  $\text{SiO}_2$ , are manufactured from mixtures of ground quartz arenite and quartzite in a mass ratio which keeps transformation during firing not too fast (arenite) and not too slow (quartzite). 1–3% CaO is added to the batch as milk of lime or as portlandite powder ( $\text{Ca}(\text{OH})_2$ ), which, in combination with a soda-iron-silicate flux frit, acts as a transformation activator (mineralizer) and sintering aid. The batch is plastified, normally with 2% of thickened sulfite lye, to facilitate shaping by pressing, tamping, or hand molding and, in combination

with the lime, to give sufficient strength to the shaped and dried bodies in the green state. The batch must be very low in alumina (< 1%); 9% of  $\text{Al}_2\text{O}_3$  [492] lowers the melting temperature by ca. 140–180 K. Other impurities from the raw material are  $\text{TiO}_2$ ,  $\text{Fe}_2\text{O}_3$ ,  $\text{Na}_2\text{O}$ , and  $\text{K}_2\text{O}$ . Superduty silica bricks contain < 0.5% ( $\text{Al}_2\text{O}_3 + \text{TiO}_2 + \text{Na}_2\text{O} + \text{K}_2\text{O}$ ) and ca. 3%  $\text{CaO}$ .  $\text{Al}_2\text{O}_3$  here may be completely replaced by  $\text{MgO}$  and  $\text{MnO}$ . The bricks are fired in annular, chamber, or tunnel kilns at ca. 1725–1875 K. A firing cycle in a tunnel kiln takes 7–14 d. During firing an intergranular alkali calcium iron silicate partial melt forms (Figure 48.35), dissolving  $\text{SiO}_2$  from the quartz grains and precipitating cristobalite and tridymite. Simultaneously, quartz is transformed into cristobalite in the solid state. At the beginning of firing the amount of cristobalite increases, but with time under the action of the mineralizers it is transformed into tridymite [494, 495]. The cold brick consists of nearly equal amounts of cristobalite and tridymite, residual quartz, and a glass phase (the frozen partial melt) from which wollastonite,  $\text{CaSiO}_3$ , magnetite,  $\text{Fe}_3\text{O}_4$ , calcium ferrite,  $\text{CaFe}_2\text{O}_4$ , and dendritic cristobalite have crystallized.

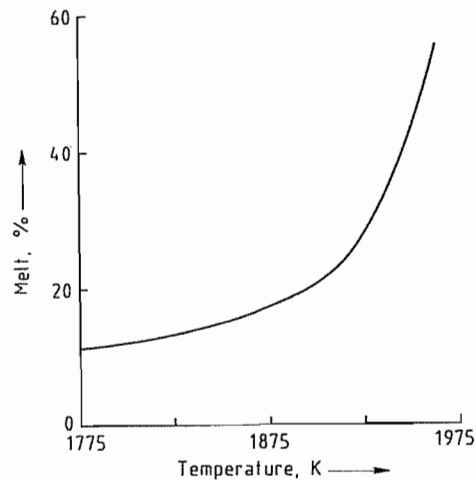

Figure 48.35: Fraction of Al-Ca silicate partial melt in the system  $\text{Al}_2\text{O}_3$ - $\text{CaO}$ - $\text{SiO}_2$ , with 1%  $\text{Al}_2\text{O}_3$  and 2%  $\text{CaO}$ , as function of temperature [493].

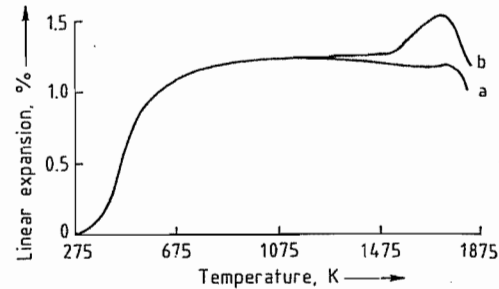

Figure 48.36: Thermal expansion of refractory silica bodies: structural volume change due to displacive (low temperature) and reconstructive (high temperature) transformations of silica polymorphs and microstructural volume change due to formation of microcracks [498]: a) < 0.5%; b) ca. 5% residual quartz.

The crystalline phases in refractory silica are determined quantitatively by X-ray powder diffraction. This, however, is complicated by the extreme microcrystallinity of cristobalite formed in the solid state, the varying degree of stacking disorder of cristobalite and tridymite, and the diffuse background scattering from the glass phase, which can lead to wide error limits [496, 497]. An excess of residual quartz after firing must be avoided because of the volume increase (after-expansion) (Figure 48.36) that occurs when it is transformed into cristobalite tridymite during use. A small amount of quartz (1–5%) may be desirable for increasing the strength of a furnace vault, for example, by generation of compressive stress.

**Properties.** In comparison with fireclay products, refractory silica has outstanding high-temperature strength. This high load-bearing capacity enables its use under load up to 1920 K; super-duty bricks can be used up to 1980 K. Refractory silica does not shrink during use, and above 850 K it has excellent thermal shock resistance due to its very low thermal expansion. Thermal conductivity is low; it can be increased by admixture of  $\text{SiC}$ .

Silica bricks are highly resistant to attack by acidic iron silicate melts but they dissolve readily in glass melts. The open porosity varies between 15 and 25 vol%. Superduty bodies are less porous and less permeable to gases.

Table 48.13: Specifications for coke oven silica bricks.

| Type         | Open porosity, vol % | Component, %   |                         |                         |              |  | Compression strength, MPa |
|--------------|----------------------|----------------|-------------------------|-------------------------|--------------|--|---------------------------|
|              |                      | $\text{SiO}_2$ | $\text{Al}_2\text{O}_3$ | $\text{Fe}_2\text{O}_3$ | $\text{CaO}$ | $(\text{Na}_2\text{O} + \text{K}_2\text{O})$ |                           |
| Low density  | $\leq 24.5$          | $> 94.5$       | $\leq 2.0$              | $\leq 1.0$              | $\leq 3.0$   | $\leq 3.5$                                   | $\geq 28$                 |
| High density | $\leq 22.0$          | $\geq 94.5$    | $\leq 1.5$              | $\leq 1.0$              | $\leq 3.0$   | $\leq 3.5$                                   | $\geq 35$ –45             |

Table 48.14: Physical forms of quartz raw materials.

| Name               | Formation and properties  | Remarks, synonyms, and trivial names                                |
|--------------------|---|---|
| Idiomorphic quartz | freely grown, euhedral faced, monocrystalline, possibly twinned, transparent colorless or smoky to dark brown or black  | rock crystal, smoky quartz  |
| Lump quartz        | fragmented, anhedral, monocrystalline, may be twinned, transparent, colorless, smoky, milky, or white   | chunk quartz, lascas, brazil pebbles, lump silica                   |
| Quartz pebbles     | weathering product from quartz veins, worn by action of water, smoothly rounded, mono- or polycrystalline, transparent to white or yellowish white or gray  | if transparent: rhinestone or rhenkiesel, grain size 2–60 mm        |
| Granular quartz    | xenomorphic product of natural (weathering) or industrial processing from granitic-pegmatitic rocks, monocrystalline, may be twinned, transparent to translucent, yellowish, gray, or smoky   | grain size 0.5–1 mm [503]   |
| Quartz sand        | unconsolidated, wind- or water-eroded and transported weathering product of fragmental rocks, grumpled into mono- or polycrystalline grains, rounded or angular anhedral, the majority of grains are discernible with the naked eye, white to yellowish in bulk, in the individual grain transparent to translucent | silica sand, grain size 0.06–2.0 mm                                 |
| Quartz powder      | unconsolidated product of grinding or milling of coarser quartz, individual grains not discernible with the naked eye, white opaque in bulk   | quartz flour, silica powder, silica flour, grain size 0.002–0.06 mm |
| Quartz rock        | consolidated by intergrowth of grains or by cementation of grains by quartz   | see text and Table 48.11  |

The principal disadvantage of silica bricks arises from displacive transformations of the  $\text{SiO}_2$  polymorphs below 850 K (Table 48.8 and accompanying volume increase (Figure 48.36), which produces internal stress, cracking, and spalling unless extreme care is taken during heating and cooling in the range between ambient temperature and 850 K.

Uses of silica bricks include sprung arches of open-hearth furnaces, covers of electric furnaces, roofs of glass tank furnaces, blast preheaters, and coke and gas ovens [499, 500]. Specifications for coke oven silica bricks are listed in Table 48.13. Unshaped masses of refractory silica are used for monolithic constructions and repairs.

**Cristobalite sand** is produced from quartz sand in rotary furnaces at 1800 K, and cristobalite powder from flint in shaft furnaces with subsequent grinding. They are used as refractory mortars and ramming mixes in ceramic kilns and for blending with quartz or other mineral sands for various uses (e.g., in found-

ries). Heat-insulating lightweight (up to 60% porosity) silica refractories are produced by including a sufficient quantity of material that burns off during firing (e.g., sawdust, cork, fruit seeds, olive oil cake). Diatomaceous earth can also be used as raw material and already has a high porosity. Burned diatomite consists of about 80% crystalline silica—mainly cristobalite with some quartz and is an extremely lightweight heat-insulating material for use at temperatures up to 1200 K.

## 48.7.2 Quartz Raw Materials

### 48.7.2.1 Physical Forms and Occurrence

The range of quartz raw materials in nature is vast. Table 48.14 describes the physical forms of quartz raw materials [501–506].

Quartz gravel and sand are the most important raw materials on a volume basis; the construction industry consumes about 95% of

production (ca. 65% structural and ca. 30% civil engineering).

The main characteristics for quartz raw materials are chemistry, mineralogy, physical properties, and cost. Increasing demand for extremely pure quartz for silica glass production and in the quartz-oscillator industry, and the growing use of refined grades in many other industries makes consistency and long-term availability important [505].

Impurities and their accessibility to beneficiation processes are of major importance. In most cases, trace element analysis gives bulk composition and no information about the localization of impurities in the microstructure. Microstructural information, however, is es-

sential for choice of quartz processing methods. Figure 48.37 shows the principles of impurity distribution in a crystal.

**Tripoli** (see Table 48.11) contains ca. 98–99%  $\text{SiO}_2$ . It occurs in sedimentary strata as a natural leaching product of calcareous cherts or siliceous limestones. White tripoli is low in iron impurities ( $< 0.1\% \text{Fe}_2\text{O}_3$ ); "rose" or "cream" tripoli contains up to 1%  $\text{Fe}_2\text{O}_3$ . The quartz crystallites are submicroscopic; tripoli particles of 10–70  $\mu\text{m}$  are crystallite aggregates. Southern Illinois (white) tripoli has the composition (%):  $\text{SiO}_2$  99.5,  $\text{Al}_2\text{O}_3$  0.009,  $\text{Fe}_2\text{O}_3$  0.025,  $\text{CaO}$  0.15,  $\text{TiO}_2$  0.005.

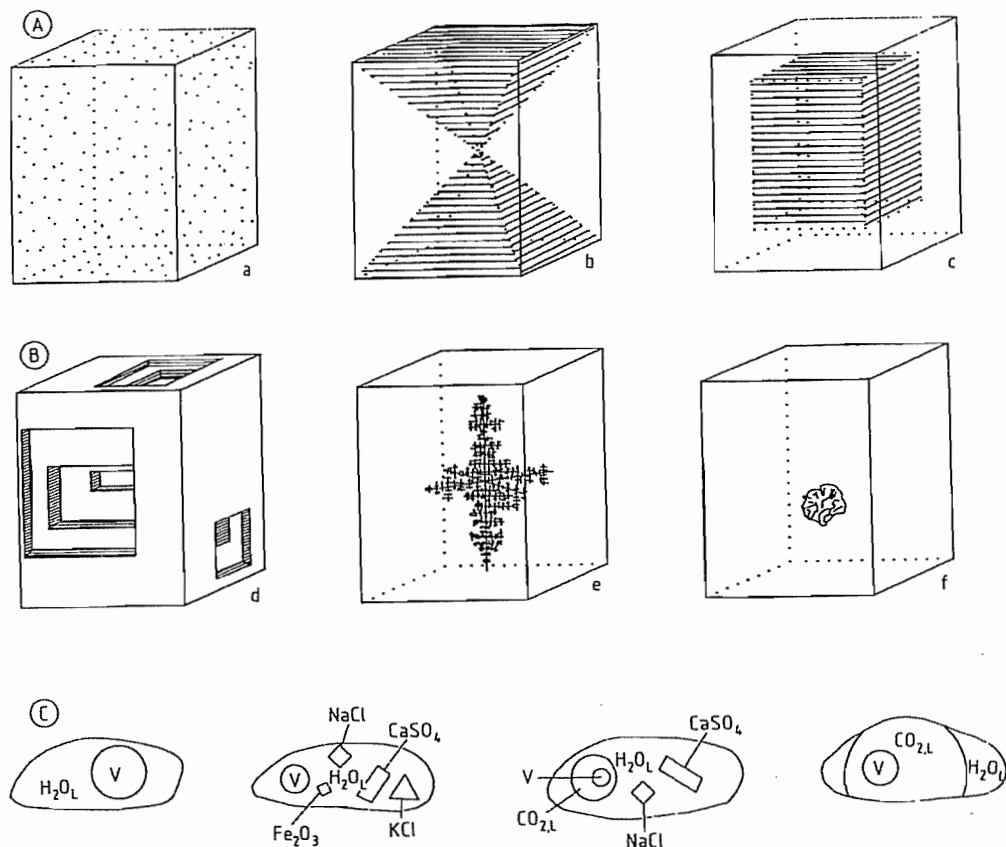

**Figure 48.37:** Principles of impurity distribution in a single crystal. A) Structural incorporation: a) Random; b) Growth sector specific; c) Zonal. B) Microstructural inclusion: d) Skeletal growth; e) Dendritic growth; f) Accumulated and accidental growth. C) Types of fluid inclusions in quartz [512]: V = vapor, L = liquid in the system  $\text{H}_2\text{O}-\text{CO}_2$  (for other systems, e.g.,  $\text{H}_2\text{O}-\text{CO}_2-\text{CH}_4$ , see [508]). Squares, rectangles, and triangles represent crystals.

**Chalcedonies** (Section 48.7.1.2) are classified according to their deposition as wall-banded CH-W or horizontally banded CH-H and according to the optical character of fiber elongation (chalcedony CH-W<sub>LF</sub> or -H<sub>LF</sub>; quartzine CH-W<sub>LS</sub>). Chalcedony occurs in various geological environments, filling veins, vugs, and vesicles of magmatic volcanites and sediments [513].

In reflected light chalcedony CH-W is translucent bluish gray (or brownish if impregnated in nature with ferrous humic acid waters); CH-H is milky to white opaque, depending on the content of opal-CT [514].

The translucent CH-W possesses an open microporosity which makes it impregnable (e.g., with coloring solutions) and allows penetration of liquid impurities. However, the microstructure is monomineralic and of high toughness, which makes it a good material for milling devices and bearing stones.

CH-W<sub>LF</sub> is slightly softer than CH-W<sub>LS</sub>. Therefore, during use CH-W<sub>LS</sub> layers which are always present, form a raised abrasion relief. However, since the resistance of CH-W<sub>LF</sub> to etching with HF is higher than that of CH-W<sub>LS</sub>, etch levelling is possible. CH-H has al-

most no open porosity, the space between the chalcedony spherulites (Table 48.9) being filled with opal-CT. The abrasion resistance of CH-H is low.

#### 48.7.2.2 Processing

Impurities that are structurally incorporated in quartz are very difficult or impossible to remove. However, included impurities and those that form surface films can be removed by appropriate processing measures.

Purity grades of processed natural quartz raw materials are [503]:

| Grade       | Impurity content (ppm) |
|-------------|------------------------|
| Low         | > 500                  |
| Medium high | 300–500                |
| High        | 2–50                   |
| Ultrahigh   | 1–8                    |

#### Processing of coarse monocrystalline quartz to lumps or lascas [503]:

- Removal of grown surfaces and visible adhering foreign minerals with a hammer (ca. 50% loss in mass)
- Size reduction to lumps or lascas (weight specification for lascas ca. 15–50 g)

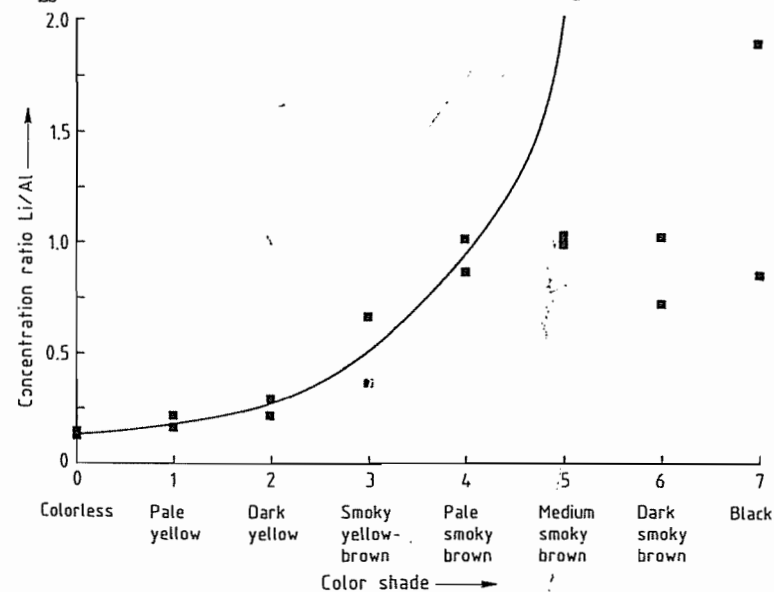

**Figure 48.38:** Irradiation ( $\gamma$ -radiation, dose 1 Mrad) color and Li/Al concentration relationship for initially colorless first-grade lascas (Minas Gerais, Brazil) [503].

● Sorting out of pieces with visible inclusions and for different transparency grades under visible light in water as immersion medium

● Sorting out of fluorescing pieces (inclusions of transparent and colorless foreign minerals and glass fragments)

*Product:* Various grades of lascas

The impurity content (ppm) of Arkansas-lascas of grade 1 (clear, free of crystal surfaces) and grade 4 (white opaque) is [505]:

|         | Al | Fe | Mg | Ca | Li | Na | K  | Ti |
|---------|----|----|----|----|----|----|----|----|
| Grade 1 | 15 | 2  | 1  | 1  | 1  | 2  | 2  | 25 |
| Grade 4 | 20 | 5  | 1  | 1  | 1  | 25 | 10 | 64 |

**Irradiation-aided processing of lascas [503]:**

●  $\gamma$ -Irradiation ( $^{60}\text{Co}$ ) with doses  $\geq 1$  Mrad [515]

● Color sorting of pieces with irradiation activated Al- and Fe-color centers. Irradiation color and depth is mainly a function of the Li/Al concentration ratio [503] (Figure 48.38)

● Thermoluminescence sorting

*Product:* medium high to high purity grade lascas

**Processing of quartz lascas to granular quartz [503]:**

● Cold washing in counterflow with aqueous 2% HF solution

● Heating to  $> 850$  K (transformation into high quartz)

● Quenching in cold deionized water (fracturing by thermal expansion shock)

● Sorting out of red, iron-colored pieces and pieces with rutile-inclusions on a conveyor belt under visible light

● Grinding and sizing

● High-field magnetic and dielectric separation [516]

● Chlorination at ca. 1300 K to remove metal impurities and burn out organic impurities

*Product:* high purity grade granular quartz. Prices of processed quartz materials are listed in Table 48.15.

**Table 48.15:** Prices of processed quartz raw materials in January 1989 (in 1992, prices for lascas and granular quartz were about four times higher) [517].

| Commodity                                | Grade   | Price, DM/kg                  |
|--|---|-------------------------------|
| Quartz sand                              | 98.5% SiO <sub>2</sub>  | 0.06 <sup>a</sup>             |
| Lump vein quartz                         | 99.9% SiO <sub>2</sub>  | 2.40                          |
| Lascas                                   | 99.9–99.997% SiO <sub>2</sub>                                 |                               |
| milky white                              | IV  | 1.50                          |
| dull milky                               | III   | 2.50                          |
| translucent                              | II  | 4.00                          |
| transparent                              | I   | 7.00                          |
| water clear                              | extra   | 10.00                         |
| Granular quartz (100–300 $\mu\text{m}$ ) | glass tank, optical lamp tubing semiconductor low alkali (LA) | 1.50<br>4.00<br>7.00<br>10.00 |

<sup>a</sup> Prices increase by factors of 2–10 with decreasing impurity content.

**Processing of quartz from feldspar-pegmatite [503]:**

● Crushing and grinding

● Multistage flotation to separate mica, garnet and feldspar; refloatation of the quartz tailings

● High-field magnetic separation

*Product:* medium high grade granular quartz (e.g., Quintus quartz from Spruce Pine pegmatite, North Carolina, United States, non-volatile impurity level  $< 400$  ppm Si).

Worldwide capacity for production of granular quartz is ca. 17 000 t/a with more than 50% in the United States, with ca. 6000 t from Spruce Pine, North Carolina alone [517].

**Processing of medium high purity quartz to high-purity quartz [503]:**

● Sizing into 5 grain fractions and further processing of the individual fractions

● Acid (HF, HCl, H<sub>2</sub>SO<sub>4</sub>) leaching until HF is completely converted to fluorosilicic acid

● Elutriation by washing and decanting with deionized water until pH  $\geq 6$  is reached, and the suspended fine particles are removed

● Vacuum drying

● High-field magnetic separation

● Blending of the 5 fractions

● Treatment with HCl gas at  $\geq 1400$  K to remove metal impurities and water

**Table 48.16:** Analyses and prices of various IOTA quartz grades [503, 517].

| Grade            | Analysis, ppm |     |     |          |     |     |     |     | Price, \$/kg |      |
|------------------|---------------|-----|-----|----------|-----|-----|-----|-----|--------------|------|
|                  | Al            | Fe  | Ti  | Mg       | Ca  | Li  | Na  | K   | 1989         | 1992 |
| Lamp tubing (LT) | 32.9          | 3.1 |     | 0.1      | 4.6 |     | 5.9 | 5.8 | 2.0          | 2.5  |
| Standard (ST)    | 17.7          | 0.7 | 1.1 | 0.1      | 0.5 | 0.6 | 1.0 | 0.6 | 2.3          | 2.57 |
| 4                | 6.8           | 0.3 | 1.5 | 0.1      | 1.0 | 0.2 | 1.0 | 0.4 | 3.5          | 4.52 |
| 6                | 6.8           | 0.1 | 1.0 | $< 0.05$ | 0.4 | 0.1 | 0.1 | 0.1 | 6.0          | 9.5  |

*Product:* high-purity granular quartz (e.g., IOTA quartz, impurity level  $< 30$  ppm Si)

Trace element analysis (ppb) of high-purity granular quartz grades [517]:

| Grade      | Li     | Na     | K      | Mg      | Ca      | Si     |
|------------|--------|--------|--------|---------|---------|--------|
| IOTA-6     | 100    | 100    | 100    | $< 50$  | 400     | $< 50$ |
| Low-alkali | $< 20$ | $< 40$ | $< 40$ | $< 100$ | $< 400$ |        |

| Grade      | Al       | Ti       | Ge     | Zr      | P      | V      |
|------------|----------|----------|--------|---------|--------|--------|
| IOTA-6     | 6800     | 1000     | 600    | 100     | $< 50$ | $< 50$ |
| Low-alkali | $< 8800$ | $< 1800$ | $< 40$ | $< 100$ | 100    |        |

| Grade      | Cr     | Mn     | Fe      | Co     | Ni     | Cu     | Zn     |
|------------|--------|--------|---------|--------|--------|--------|--------|
| IOTA-6     | $< 50$ | $< 50$ | 100     | $< 50$ | $< 50$ | $< 50$ | $< 50$ |
| Low-alkali | $< 50$ | $< 50$ | $< 500$ | $< 10$ | $< 50$ | $< 50$ | $< 50$ |

Analyses and prices of various IOTA grades are listed in Table 48.16.

**Processing of quartz gravel:**

● Separation of sand, blending with a given fraction of sand

● Washing to remove clay minerals

● Separation of residual sand

● Sizing and drying

*Product:* filter pebbles

Beach pebbles are already processed by nature (*product:* milling stones).

**Processing of quartz sand [518, 519] varies depending on required grade. Important steps in the wet process are:**

● Purification washing to remove loosely adhering impurities

● Friction washing (attrition), crushing and cleavage of agglomerated grains in acid (pH  $< 3$ , H<sub>2</sub>SO<sub>4</sub>) or alkaline (pH 10, Na<sub>2</sub>CO<sub>3</sub>) water, rubbing off strongly adhering impurities (iron oxides, clay minerals)

● Screening Multistage flotation to remove a) micas; b) hematite, magnetite, rutile, andalusite, etc.; c) feldspars

● Chemical beneficiation with aqueous sulfuric and oxalic acid solution or dilute HF solution. Chlorination with HCl gas at ca. 600 K

● Physical beneficiation, magnetic and electrostatic separation of iron contaminants and feldspars

*Products:* quartz sand, various grades; sands for glass melting, foundry and chemical products.

**Quartz powders** are produced by dry grinding in encapsulated nodular-chert-lined mills with flint or corundum pebbles.

**Processing of quartz rocks** includes breaking, milling (with quartz rock lumps and steel balls), sieving, washing, and sizing [518, 519].

Biological removal of iron impurities with cultures of acid producing bacteria or fungi (e.g., *Aspergillus niger*) on a nutrient of molasses is discussed in [520].

### 48.7.2.3 Uses

Important uses of quartz raw materials or semifinished materials are listed below [505]:

| Use                                 | Raw or semifinished material                       |
|-------------------------------------|--|
| Abrasives and grinding media        | sand, powder, tripoli, novaculite                  |
| Ceramics                            | quartzite, quartz-cemented sandstone, sand, powder |
| Chemicals                           | sand, powder                                       |
| Construction of buildings and roads | gravel, sand, powder, quartzite, sandstone         |
| Fillers, extenders                  | powder, tripoli                                    |
| Filters                             | gravel, sand                                       |
| Foundry                             | sand   |
| Gems                                | monocrystalline quartz, chalcidony, agate chert    |
| Glasses, enamels, glazes            | sand, powder                                       |
| Hydrothermal growth of quartz       | lump quartz, granular quartz                       |
| Metallurgy                          | quartzite, sandstone, sand, powder                 |
| Milling                             | silex, chalcidony, flint, quartzite                |

| Use   | Raw or semifinished material                      |
|---|---|
| Optical and oscillator devices              | monocrystalline cultured and natural quartz       |
| Silicon metallurgical grade, silicon alloys | lump quartz, quartzite, quartz-cemented sandstone |
| Vitreous silica                             | lump quartz, granular quartz, sand                |
| Well fracturing                             | sand  |

**Abrasives and Grinding Quartz.** Quartz sand and powder are used for grinding, scouring, and polishing. The conchoidal fracture, hardness, and brittleness provide and maintain during use particles with sharp cutting edges. The use of quartz in sandblasting is decreasing due to health hazards. Quartz sand is also of declining importance for sandpaper. Quartz powder is utilized in abrasive soaps and in scouring powders. Sandstones are used for grinding. Tripoli is friable, with a grain size of 0.1–5  $\mu\text{m}$ , and its grains have no sharp edges. Tripoli grades with 98–99%  $\text{SiO}_2$  are used for polishing [521]. Novaculite from Arkansas and Missouri, United States, has a microstructure of minute angular quartz grains with open porosity. It is used as oil-soaking whet- and honing stone. Whetstone grades range in porosity from 0.1 to 15% [521].

**Ceramics.** Batches for stoneware, porcelain, fireclays, and aluminum silicate refractories contain quartz as a nonplastic filler and glass former. White-burning, low-iron quartz powders produced from sand, flint, or quartz rocks (quartzite, novaculite) are used. Flint is calcined before grinding. In pottery and earthenware, quartz sand and powder act as nonplastic fillers [522].

**Chemicals.** A wide range of chemicals is produced from quartz. Here, only two important products that are representative of different reaction processes and reaction temperatures are mentioned.

Sodium or potassium silicate from the furnace route are melted from quartz sand and the alkali metal carbonate. Usually the sand is of container-glass grade with  $\leq 0.1\%$  each of  $\text{Al}_2\text{O}_3$  and  $\text{CaO}$  and a very low iron content ( $\leq 0.02\%$   $\text{Fe}_2\text{O}_3$ ). Very high purity products require sand with  $\leq 0.02\%$   $\text{Al}_2\text{O}_3$  and  $\text{CaO}$  each.

Melting is performed in tank furnaces at ca. 1700 K [523].

Water glass from the hydrothermal route is produced in autoclaves by reaction of quartz sand with aqueous  $\text{NaOH}$  solution at ca. 430–500 K.

Silicon carbide is produced from crushed lump quartz or sand with the specification in %: 99.5  $\text{SiO}_2$ ,  $< 0.1 \text{ Al}_2\text{O}_3$  and  $\text{Fe}_2\text{O}_3$  each,  $< 0.01 \text{ CaO}$ ,  $< 5 \text{ H}_2\text{O}$  by reaction with coke and some ingredients at ca. 2300 K. Production of 1 t  $\text{SiC}$  requires ca. 1.5 t  $\text{SiO}_2$ .

**Construction of Buildings and Roads.** Quartz sand is an integral part of mortar; quartz sand and gravel are additives for portland cement and asphalt. Tripoli is used as an inert filler and extender in asphalt.

Quartz sandstone, with various cementing materials and colors, and quartzite have long been used as building stones [524]. Bricks and tiles are fired from mixtures of quartz sand and clay. Since the early 1900s hydrothermally hardened lime-silica bricks (synonyms: calcium silicate bricks, sand-lime brick) have developed rapidly as building materials [525]. Quartz sand is reacted with hydrated lime and various additives in an autoclave at ca. 500 K and ca. 16 bar  $\text{H}_2\text{O}$  pressure. One of the essential process parameters is the grain-size distribution of the sand. Films of clay mineral or iron oxide on the quartz grains slow down the reaction of quartz with hydrated lime. The hardening reaction forms calcium silicate hydrate phases with very high water contents. This gives the material a high heat capacity, but the heat insulating capacity is low. It is increased by addition of slag granules or coal ash (power plant by-products).

**Fillers and Extenders.** Quartz powder and tripoli act as hard, inert fillers and extenders in paints and coatings, plastics, and rubbers. In paints quartz increases the resistance to acids and improves flowability, durability, and wear resistance. In plastics compressive and flexural strength and resistance to thermal shock and heat are improved. The insulator character of quartz and its surface leakage current resistivity make quartz fillers valuable for epoxy

resin encapsulation of electronic devices and for filling and fixing of coils. Quartz is used as a filler in rubbers instead of carbon black when colors other than black are required. In tire linings it gives improved heat aging, adhesion, and tear strength.

**Filters.** Quartz pebbles, preferably monocrystalline, and sand are the main filter materials for drinking water purification and softening.

**Foundry Technology** [504, 518, 519, 526]. Quartz sand is used in molds and cores. Refractoriness (i.e., the temperature at which sintering begins; ca. 1500–1700 K, depending on content of feldspar), thermal shock resistance, cohesiveness in the moist state, and high-temperature strength are the most important properties. For cast iron the mold must contain  $\geq 85\%$   $\text{SiO}_2$  and for steel castings,  $\geq 95\%$ . Granulometric factors such as particle-size distribution, grain shape, state of grain surfaces, and surface area are also important. Coarse sand with low surface area requires less binding agent (usually montmorillonitic clay). Monocrystalline well-rounded grains ensure good permeability to gases evolved during casting. Mold surfaces made of fine sand give smooth molding surfaces that do not require machine finishing. The sands may naturally contain enough clay minerals for good mold strength, or require addition of binders, which increases costs.

Table 48.17: Quartz raw materials for glasses and enamel frits.<sup>a</sup>

| Glass type                          | Raw material | Composition, % |                         |                         |                         |                       |                      |                      | Grain size range <sup>b</sup> , mm |
|-------------------------------------|--------------|----------------|-------------------------|-------------------------|-------------------------|-----------------------|----------------------|----------------------|------------------------------------|
|                                     |              | $\text{SiO}_2$ | $\text{Al}_2\text{O}_3$ | $\text{Fe}_2\text{O}_3$ | $\text{Cr}_2\text{O}_3$ | $\text{Na}_2\text{O}$ | $\text{K}_2\text{O}$ | $\text{H}_2\text{O}$ |                                    |
| Optical and ophthalmic <sup>b</sup> | sand         | 99.7–          | 0.02–                   | 0.004–                  | 0.00005                 | 0.005–                | 0.003–               | 0.08–                | 0.125–1 (mean 0.25)                |
|                                     | powder       | 99.9           | 0.05                    | 0.0025                  | –0.0001                 | 0.006                 | 0.008                | 0.11                 |                                    |
| Borosilicate                        | powder       | 99.88          | 0.04                    | 0.013                   | 0.0003                  | 0.004                 | 0.009                | 0.006                | 0.125–1 (mean 0.25)                |
| Flat                                | sand         | 98–99          | 0.2–1.6                 | 0.02–0.2                |                         |                       |                      | $\leq 5^c$           | 0.16–1 (mean 0.25)                 |
| Colored container                   | green        | $\geq 98.5$    | 1–6                     | $\leq 0.3$              |                         |                       | $\leq 53$            |                      | 0.16–1 (mean 0.25)                 |
|                                     | brown        | $\geq 98.5$    | 1–6                     | $\leq 1$                |                         |                       | $\leq 53$            |                      | 0.16–1 (mean 0.25)                 |
| Enamel                              | powder       | $\geq 97.5$    | $\leq 0.6$              | $\leq 0.2$              |                         |                       |                      |                      |                                    |

<sup>a</sup> Variation must be  $\leq 0.03\%$  of the value; grains of difficultly dissolving accessory minerals (e.g., chromite, sillimanite, corundum) must be avoided or  $\leq 0.2 \text{ mm}$ .

<sup>b</sup>  $\text{MgO}$ ,  $\text{CaO}$ ,  $\text{TiO}_2$ : a few ppb.

<sup>c</sup> Water aids melting.

Specifications for foundry sand grades of different refractoriness:

|  |          |           |          |
|--|----------|-----------|----------|
| Beginning of sintering, K                    | $> 1775$ | 1575–1775 | $< 1575$ |
| Quartz, % (rest: feldspar and clay minerals) | $> 99$   | 95–99     | $< 95$   |

**Glasses, Enamels, and Glazes** [505, 511, 523, 527–530]. Different types of glasses and enamels require various grades of quartz raw materials. The silica content of glazes is mainly supplied by the silicate ingredients (feldspar, clay). If additional  $\text{SiO}_2$  is required, quartz or flint powder is added. Table 48.17 gives information on physical forms and grades of silica for glasses and enamel frits.

**Hydrothermal Growth of Quartz** [503]. Brazilian lascas were used worldwide as nutrient chips until the Brazilian quartz embargo 1974. Since then many other sources for high-purity low cost lump quartz and granular nutrient have been opened up. Iron plus aluminum impurities of  $\leq 50 \text{ ppm}$  are allowed.

**Metallurgical-Grade Silicon and Silicon Alloys.** For chemical- or metallurgical-grade silicon, quartz lumps or pebbles (25–150 mm) are reduced with coke in electric-arc furnaces. The lumps and pebbles must not decrepitate during heating and therefore should preferably be monocrystalline and free of fluid inclusions. The grade of quartz raw material depends on the required grade of the products. Metallurgical-grade silicon with 99.0% Si requires (in %):  $\geq 99.0 \text{ SiO}_2$ ,  $\leq 0.2 \text{ Al}_2\text{O}_3$ ,  $\leq 0.1 \text{ Fe}_2\text{O}_3$ ,  $\leq 0.1 \text{ MgO}$  and  $\text{CaO}$  each,  $\leq 0.02 \text{ TiO}_2$ .

Low-grade silicon (98 % Si) for steel and aluminum production needs quartz with (in %):  $98 \text{ SiO}_2$ ,  $\leq 0.4 \text{ Al}_2\text{O}_3$ ,  $0.2 \text{ Fe}_2\text{O}_3$ ,  $\leq 0.2 \text{ MgO}$  and  $\text{CaO}$  each,  $\leq 0.1 \text{ P}_2\text{O}_5$ ,  $\leq 0.002 \text{ TiO}_2$ .

Production of 1 t metallurgical-grade silicon requires ca. 2.5 t of quartz. The worldwide silicon production is ca. 650 000 t/a.

**Metallurgy.** Quartz in the form of lumps or granules of vein quartz, quartzite, or sandstone is used as flux in smelting metal ores, for slagging iron oxides and basic oxides, and for balancing the silica/lime ratio of blast furnace burdens. In both cases the  $\text{SiO}_2$  content must be  $> 90\%$  with lumps and granules in the size range of 0.8–2.5 cm.

For welding fluxes quartz powder is used with controlled grain-size distribution  $\leq 0.25$  mm with an average of 0.06 mm for coated standard electrodes. The size for quartz particles in agglomerated fluxes must be  $< 0.06$  mm.

**Milling.** Nodular chert (silex) and very finely crystalline quartzite with  $> 96\%$   $\text{SiO}_2$  and homogenous microstructure serve as linings for mills. Rounded flint nodules are preferably used as grinding pebbles.

Belgian silex consists of chalcedonic silica with evenly distributed calcite as secondary mineral phase and represents a material with high overall toughness. Yugoslavian silex has a coarser microstructure and sometimes contains coarse quartzite, but is nevertheless of very good durability. Quartzite can only be used if it is free of accessory minerals. Translucent iron-free chalcedony from agates is used in ball mills and mortars for size reduction of high-purity quartz and silica glass.

**Quartz for Optical and Oscillator Devices.** Natural monocrystalline idiomorphic quartz is preferably used for optical devices as wafer

plates, Brewster windows and prisms, birefringent filters, and tuning elements for laser optics. Only small amounts of cultured quartz are used in these applications. Oscillator quartz devices, however, are almost exclusively made from cultured quartz, for reasons of quality (low damping) and cost advantages.

**Vitreous Silica.** Transparent silica glass is melted from lumps or granular quartz with an impurity content  $< 30$  ppm, the latter being by far the most important feed. Translucent to white opaque fused silica is produced from quartz sand with an impurity content of  $\leq 300$  ppm Si. In both cases low aluminum- and iron-impurity levels are essential.

A titanium content indicates the presence of submicroscopic rutile crystallites, which cause bubble problems in transparent silica glass during tube drawing. Silica glass for semiconductor uses, if not produced from high-purity silicon compounds, must be very low in heavy metal impurities.

The impurity contents of quartz raw materials for various grades of vitreous silica are listed in Table 48.18.

**Well Fracturing.** For hydraulic fracturing of oil, gas, or geothermal wells a fluid with suspended quartz sand is pumped at high pressure into the well. Existing openings are enlarged and new voids created. When the fluid is withdrawn, the remaining sand holds the fractures open. Frac sand must have  $\geq 98\%$   $\text{SiO}_2$  and well-rounded grains to make placement easier and to provide good permeability. It must consist of single crystalline grains which are clean and, in particular, free of adhering feldspar, clay, or carbonate minerals. The solubility in hydrochloric acid (a measure of the carbonate content) must be  $< 0.3\%$ . The content of soft particles must be  $< 1\%$ .

Table 48.18: Impurity contents of quartz raw materials for various grades of vitreous silica.

| Glass grade <sup>a</sup> | Maximum impurity content, ppm |     |       |       |       |        |     |         |     |       |     |      |      |         |      |
|--------------------------|-------------------------------|-----|-------|-------|-------|--------|-----|---------|-----|-------|-----|------|------|---------|------|
|                          | Al                            | Fe  | Mg    | Ca    | Li    | Na     | K   | B       | P   | Ti    | Mn  | Cr   | Co   | Ni      | Cu   |
| 1                        | 13                            | 0.6 | 0.1   | 0.5   | 0.6   | 0.7    | 0.7 | $< 0.1$ | 0.2 |       | 0.1 | 0.08 | 0.01 | $< 0.1$ | 0.05 |
| 2                        | 20–60                         | 1–5 | 0.5–2 | 0.5–2 | 0.5–5 | 0.5–10 | 1–8 |         |     | 0.5–6 |     |      |      | $< 1$   |      |
| 3                        | 200                           | 70  | 11    | 40    | 5     | 25     | 10  |         |     | 100   |     |      |      | $< 1$   |      |

<sup>a</sup> 1: Silica glass for semiconductor uses; 2: High-purity transparent silica glass; 3: White, opaque fused silica.

## 48.7.3 Kieselguhr

### 48.7.3.1 Introduction

The term kieselguhr (diatomite) refers to sedimentary rocks that are mainly composed of the skeletons of single-celled diatoms.

The low density, high porosity and thus high absorption capacity for liquids low thermal conductivity, and outstanding filtration properties make kieselguhr a versatile raw material [531–533].

Deposits with similar petrographic character or analogous physical properties, named according to their origin or area of application, include siliceous earth, “Bergmehl”, “Saug-schiefer”, “Polierschiefer”, and tripolite, not all of which are true diatomites.

The designation “tripolite” is derived from the ancient name *terra tripolitana* (after the city of Tripolis). The name referred mainly to minerals used as grinding and polishing agents, but also as lightweight building blocks. Today, the term tripolite refers to extremely fine-grained quartz pelites of inorganic origin [534].

### 48.7.3.2 Formation, Composition, and Quality Criteria

Diatoms can be described as being almost “ubiquitous”, occurring in marine, brackish and freshwater environments.

The plant organisms possess a silicified membrane and vary in size between several micrometers and ca. 2 mm (generally 10–150  $\mu\text{m}$ ).

The skeletons are composed of opal-like amorphous silica ( $\text{SiO}_2 \cdot x\text{H}_2\text{O}$ ) and exhibit a wide range of porous fine structures and shapes. Including fossil forms, at least 15 000–20 000 different forms have been distinguished.

Rock-forming processes involving diatoms occurred worldwide from the Upper Cretaceous period onwards. Commercially exploitable deposits have been formed since the tertiary period.

The deposits are associated with sedimentation areas in which nutrients were abundant and the supply of silicates or dissolved silica was sufficient that a rich diatom flora developed and the frustules of the dead organisms accumulated to an appreciable thickness on the bed of the water body.

Such conditions are found worldwide, mainly in areas with volcanic activity, but also to a lesser extent in lakes with a largely decalcified environment and intensive chemical weathering of quartz sands or silicates (e.g., the German kieselguhr deposits) [534, 535].

Formation of diatomites of considerable thickness also occurred in marine coastal areas with continual subsidence, a periodical barrier to the open sea, and a regular supply of nutrients [536]. In addition, diatomites of brackish origin were formed in former saltwater lakes.

Important quality criteria for crude kieselguhr include the particle-size distribution, shape, and fine structure of the diatoms (Figure 48.39). However, these can be altered with regard to their structural framework (and porosity) by calcination (see Section 48.7.3.4) [537, 538], which is important for the various applications as filtration agents. Furthermore, the chemical and mineralogical composition plays an important role, since higher contents of certain components can limit economically viable processing and refinement of the crude product.

Apart from water and organic substances the most frequent additional components of diatomites are quartz, calcium carbonate, and clay minerals.

The content of water and organic substances is only of minor significance for quality assessment, since they can be removed by drying or calcination.

Quartz sands or other rock fragments of similar particle size can be removed by air classification. In this respect, the conventional specification of the  $\text{SiO}_2$  content of a crude kieselguhr is not very informative. For the assessment of a diatomite it is not the total  $\text{SiO}_2$  content which is decisive, but the content of opal (diatom skeletons).



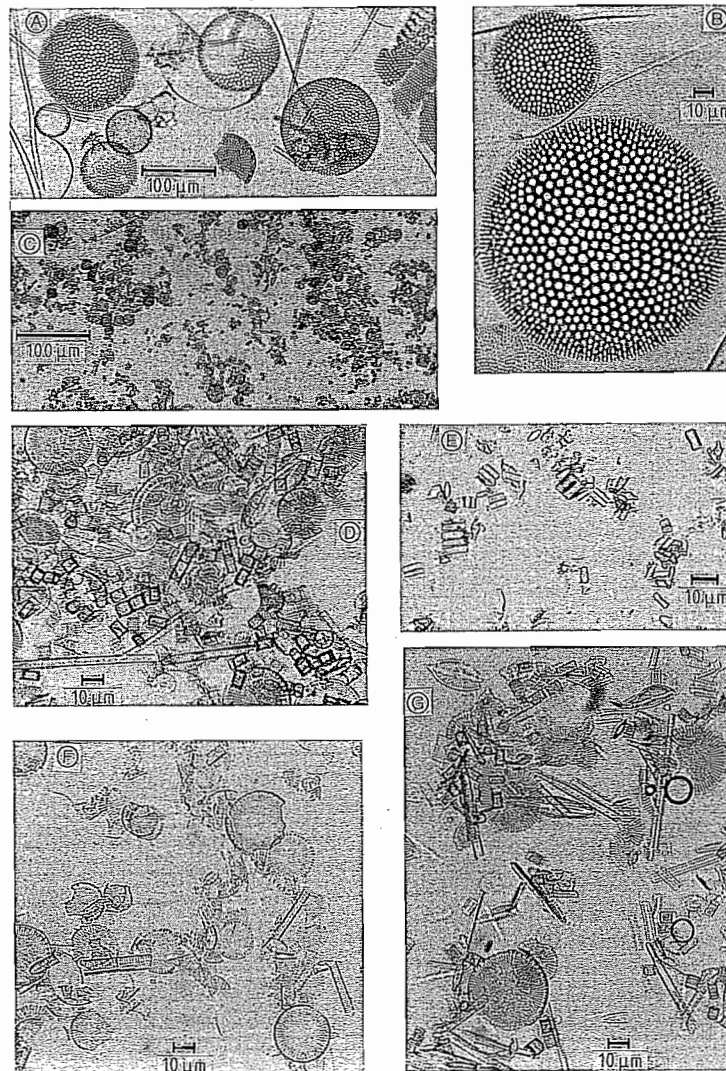

Figure 48.39: Light micrographs of various kieselguhrs (diatom fraction). A, B) Lopoc, California, USA; C) Myvatn, Iceland; D, E) Munster-Breloh, Germany; F) Hetendorf/Hermannsburg, Germany; G) Neuohe/Unterlüß, Germany.

In contrast, the presence of fine-grained carbonates [ $\text{CaCO}_3$ ,  $\text{CaMg}(\text{CO}_3)_2$ ] in amounts greater than 5–10 mol% is problematic because they form complexes during processing which adversely affect the filtration properties and lower the chemical inertness.

Clay minerals restrict the range of applications, but are advantageous for the production of insulating or refractory bricks or for use as powders.

Higher iron contents, particularly as pyrite or markasite, require refinement by calcination (see Section 48.7.3.4). The color of the diatomites becomes reddish-gray or pink due to conversion into  $\text{Fe}_2\text{O}_3$ . The filtration properties are hardly influenced, whereas the use as fillers can be affected considerably by this coloration. In the latter case, a  $\text{Fe}_2\text{O}_3$  content of > 56% can already be a limiting factor.

### 48.7.3.3 Occurrence and Mining

Diatom deposits are distributed worldwide. Their economic exploitability and market potential depend on numerous factors such as mining conditions, and processing and transport costs. The size and quality of the deposit, exploitation costs, transport conditions as well as the question whether the kieselguhr is for a domestic market or whether it is to be exported play a significant role. In 1986, the world demand for kieselguhr was ca.  $1.8 \times 10^6$  t/a [539].

The largest kieselguhr deposits in the world are found in the United States in the district of Lopoc, California. These are upper Tertiary (Miocene) marine deposits with an economically exploitable diatomite thickness of ca. 300 m. In addition, large quantities of marine and freshwater diatomites are mined in Georgia, Mississippi, Nevada, Oregon, and Washington. In 1986, the United States accounted for about one-third of world production (575 000 t), followed by Rumania, the CIS, and France, with outputs of  $(246\text{--}272) \times 10^3$  t (1986). The production in Rumania and the CIS is almost entirely used in the building construction industry. Further, noteworthy deposits and production sites are located in Algeria, Argentina, Australia, Brazil, Germany, Iceland, Italy, Kenya, Korea, Mexico, Peru, and Spain, whereby in several of these countries the export of kieselguhr is of no significance [540]. Danish "Moler" is a clay-rich diatomite (diatomaceous earth), which is produced and exported in considerable quantities (63 500–72 600 t/a). It is used predominantly for the production of insulation materials (e.g., fire-resistant insulating bricks).

The only large, economically workable kieselguhr deposits in Germany are freshwater formations of Pleistocene age. They are situated on the edge of the Luneburger Heide in the area of Hetendorf/Hermannsburg, Neuohe/Unterlüß, and Munster-Breloh as well as in the Luhetal (Bispingen/Hützel/Schwindebeck). Here industrial usage began with the establishment of the first open-cast mine in 1863. Thus, German kieselguhr mining repre-

sents the earliest modern exploitation of this raw material. Up to World War I almost the total world requirement could be met, with an export quota of > 30%.

Kieselguhr is generally mined in open-cast mines, occasionally also by subsurface or underwater mining (Myvatn, Iceland). Mining by hand is now rare (Third World countries). Almost everywhere, modern, cost-effective mining methods are used, with excavators and wheel/ front loaders, and trucks or conveyor belts for transport.

### 48.7.3.4 Processing

Worldwide, the processing methods for crude kieselguhr differ only slightly from one another. The most important principle is minimization of mechanical damage to the structure of the diatom skeletons. Hollow forms should not be destroyed and pores not blocked (e.g., by sintering during calcination). The high porosity, the most important property of kieselguhr, must be retained. The processing steps are shown in Figure 48.40.

Preliminary size reduction of crude material is carried out with spiked rollers, charging boxes, or sieve kneaders to give a uniform grain size that ensures even heat transfer during further treatment. This is particularly important because of the low thermal conductivity of kieselguhr.

The following types of processed kieselguhr are produced.

**Dried Kieselguhr.** Depending on the climatic conditions at the production site, the crude kieselguhr from the deposits is either stored in the open for predrying or transported immediately to storage hoppers. Crude kieselguhr contains 30–65% water, which is removed in countercurrent driers. Simultaneous grinding and drying is also practiced, whereby preheated air is blown into the grinders. However, this is only possible for crude products with a low moisture content. Drying is followed by gentle grinding and screening. Granulation gives products that are used as absorbants (e.g., for oil) or as pet litter.

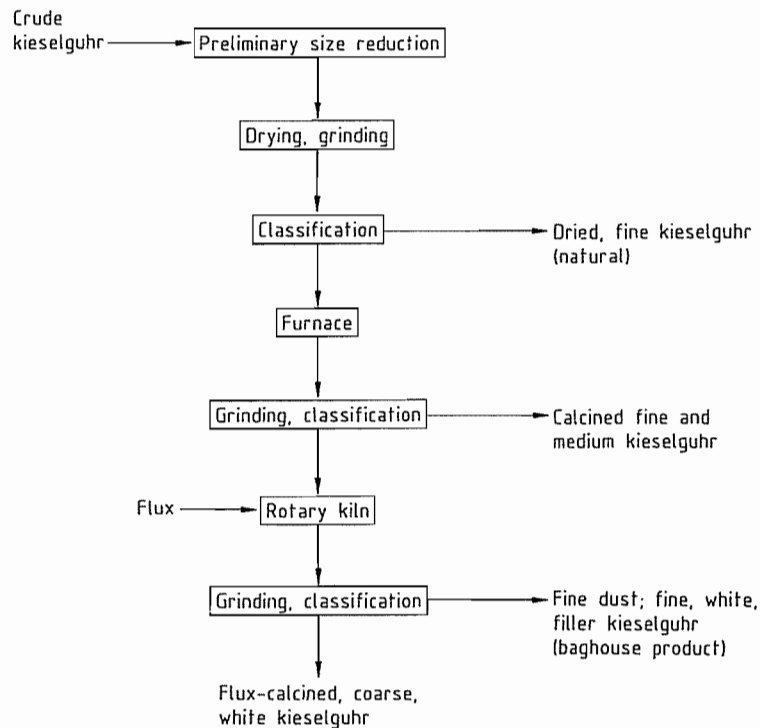

Figure 48.40: Kieselguhr processing.

Table 48.19: Chemical and physical properties of commercially available kieselguhrs.

| Property <sup>a</sup>                    | 1          | 2            | 3    | 4            | 5     | 6     | 7     | 8     | 9            |
|--|------------|--------------|------|--------------|-------|-------|-------|-------|--------------|
| Color                                    | white-gray | yellow-brown | pink | yellow-brown | brown | white | white | white | yellow-brown |
| SiO <sub>2</sub> , %                     | 89.0       | 72.5         | 90.7 | 87.5         | 86.0  | 89.5  | 90.7  | 91.5  | 90.2         |
| Al <sub>2</sub> O <sub>3</sub> , %       | 3.5        | 7.1          | 3.9  | 4.3          | 2.8   | 4.1   | 3.9   | 1.6   | 2.8          |
| Fe <sub>2</sub> O <sub>3</sub> , %       | 0.9        | 5.0          | 1.4  | 2.9          | 4.7   | 1.6   | 2.1   | 0.7   | 2.5          |
| CaO, %                                   | 1.1        | 1.2          | 0.5  | 1.9          | 0.6   | 0.5   | 1.0   | 4.4   | 0.7          |
| Na <sub>2</sub> O, K <sub>2</sub> O, %   | 0.8        | 1.4          | 0.9  | 0.8          | 0.7   | 3.6   | 3.5   | 1.9   | 0.9          |
| Ignition loss, %                         | 2.0        | 4.7          | 0.5  | 0.7          | 0.3   | 0.2   | 0.1   | 0.1   | 0.4          |
| Bulk density, %                          | 107        | 290          | 120  | 140          | 125   | 229   | 200   | 195   | 209          |
| pH value                                 | 7.0        | 5.2          | 7.5  | 6.9          | 7.0   | 10.0  | 9.7   | 9.5   | 6.7          |
| Water uptake, %                          | 255        | 200          | 250  | 205          | 201   | 156   | 160   | 200   | 196          |
| Specific surface area, m <sup>2</sup> /g | 19.2       | 25.4         | 15.2 | 13.0         | 16.1  | 1.9   | 1.6   | 3.0   | 10.6         |
| Average particle size, μm                | 14.2       | 19.3         | 15.9 | 14.1         | 13.9  | 22.5  | 30.1  | 6.5   | 14.7         |
| Wet density, g/L                         | 228        | 280          | 271  | 255          | 209   | 297   | 290   | 350   | 357          |
| Permeability, Darcy                      | 0.06       | 0.09         | 0.28 | 0.09         | 0.08  | 1.20  | 1.60  |       | 0.08         |
| Crystalline content, %                   | 2.0        | 2.2          | 7.6  | 9.2          | 9.8   | 58.1  | 59.7  | 62.7  | 10.3         |

<sup>a</sup> 1) American filter kieselguhr, dried; 2) Danish filler kieselguhr, calcined; 3) American filter kieselguhr, calcined; 4) French filter kieselguhr, calcined; 5) German filter kieselguhr, calcined; 6) American filter kieselguhr, flux calcined; 7) French filter kieselguhr, flux calcined; 8) Spanish filter kieselguhr, flux calcined, very fine; 9) German regeneration filter kieselguhr, calcined.

If the starting material is of high purity and has a low content of organic substances, the dried kieselguhr can also be used as a filtration agent or catalyst support. These kieselguhrs

vary in color from white to yellowish or gray-brown, depending on their origin, and consist predominantly of amorphous silica with a low crystalline content (generally < 3 %).

**Calcined Kieselguhr.** To remove organic substances and alter the particle size, dried kieselguhr is calcined in gas- or oil-fired rotary kilns at 800–1000 °C. During calcination, the diatom frustules and their fragments are hardened and partially agglomerated by sintering. The degree of sintering can be controlled by altering the temperature and duration of the process. The kieselguhr is then ground and classified by cyclones and sorters into grades with different particle-size distributions (fine and medium calcined kieselguhrs). Iron impurities, present as Fe<sub>2</sub>O<sub>3</sub> after calcination, color the products pink or yellowish to dark brown.

The old-fashioned furnaces with several decks, similar to pyrite-roasting kilns, are still used to a limited extent. They have the advantage of a slow calcination process at relatively low temperature which causes little damage to the structure. The kilns are loaded with moist crude kieselguhr, which is dried on the upper decks, calcined in the middle, and cooled on the lower decks.

Fluidized-bed drying and calcination processes were tested as early as the 1920s, but were unsuccessful due to technical problems. Nowadays modern fluidized-bed technology is also used for the processing of kieselguhr. Advantages include energy savings, short production times, mild treatment of the kieselguhr, and more compact design of the plants.

**Flux-Calcined Kieselguhr.** In this process, dried or calcined kieselguhr powder is calcined with the addition of alkaline fluxes. Sodium carbonate is generally used as flux in amounts of 1–6 %, either mixed with the kieselguhr before calcination or continuously added during calcination. The calcination temperature is 1000–1200 °C. The addition of sodium carbonate leads to the formation of a sodium silicate glass melt which binds the diatom frustules and their fragments into agglomerates. Since the iron contained in the kieselguhr is also bound, a white product is formed. The degree of agglomeration can be controlled by varying the temperature, the type and amount of flux, and the reaction time. This process is also known as activation. The

high calcination temperatures in the presence of alkali lead to a partial transformation (up to 65 %) of the amorphous silica into cristobalite, a crystalline silica modification. The porosity and the specific surface area are strongly decreased. The annealing and cooling processes are followed by grinding and classification, to give white filter kieselguhr (the main product) and a dust-like fine fraction which is used as white filler and auxiliary.

**Commercially Available Forms, Products, and Producers.** Powder kieselguhr is sold in paper sacks containing 15–25 kg as well as loose in big-bags and silo trucks. Granulated material is available in paper or plastic sacks containing 30 kg, sometimes also in big-bags or silo trucks.

Examples of commercial products are:

Celatom (Eagle-Picher Minerals Inc., Reno, USA)

Celite (Celite Corp., Newark, USA)

Clarcel (Ceca SA, Paris, France)

Dicalite (Grefco Inc., Torrance, USA)

Fina/Optima (Meyer-Breloh, Munster, Germany)

Skamol (Skarrehage Molerværk a/S Nykøbing, Mors, Denmark)

Table 48.19 lists the chemical and physical properties of several commercially available kieselguhrs.

#### 48.7.3.5 Analysis

Chemical and physical testing begins with the crude kieselguhr in the mine, continues during the individual production stages, and finishes with the test certificate of the end product. The results of the crude kieselguhr tests determine the working plan for the different regions of an open-cast mine.

The following analyses and tests are undertaken.

**Chemical Analysis.** The contents of silica, iron, aluminum, calcium, magnesium, manganese, titanium, sodium, potassium, and, depending on requirements, also other elements are determined after alkaline dissolution or acidic extraction. Filter kieselguhrs for breweries are also tested for beer-soluble iron, calcium, and sometimes other elements [541].

**Physical Tests.** Water content, loss on ignition (at 1050 °C), bulk density, tapped density, pH value (10% in water), water absorption capacity, and specific surface area are determined by conventional methods [541]. The particle-size distribution is determined by laser scattering or air-jet screening. For the fine fraction, the sedimentation method is used. The wet density is the density in g/L of a filter cake flushed with water. Since the majority of kieselguhr is used for filtration, the determination of the permeability is of major importance since it determines the performance and the retaining power of a filter kieselguhr. In general, the methods developed by the individual producers in which the rate of permeation of water is measured, are sufficient. The company CECA (France) possesses a patent for a permeameter which allows fully automatic measurement. The EBC filter is of simpler construction and allows Darcy values to be precisely measured [542]. Apart from the relative units used by the diverse producers, the Darcy has become generally accepted as the unit for the permeability of a filter agent. For filter materials with the permeability of 1 Darcy the flow rate of a liquid of viscosity of 1 mPa·s is 1 mLs<sup>-1</sup>cm<sup>-2</sup> filter area for a filter-cake thickness of 1 cm and a pressure difference of 0.1 MPa. Since the permeability can be determined rapidly, this is a suitable method for differentiating between fine, medium, and coarse kieselguhrs [541, 543–545].

The amorphous silica content of a kieselguhr is determined by the alkali solubility. This property is of significance for catalyst kieselguhrs, or for kieselguhrs which serve as a silica source in cement, or as chemical reagents in other silica-containing products. The specific surface area is used to assess the porosity of a kieselguhr. It is generally determined by nitrogen adsorption (BET method). The degree of whiteness is measured with a leucometer.

#### 48.7.3.6 Storage and Transport

Processed kieselguhr is stored in steel or stainless steel silos, mostly with a circular

cross section and equipped with various discharge aids, since kieselguhr tends to form bridges. Material packed in sacks is stored and transported on wooden palettes in amounts of 600–1000 kg enveloped by a shrink film, and also in big-bags made from plastic-coated webbing with a capacity of 600–1500 kg. Loose material is transported in silo road vehicles or rail containers with a capacity of 30–75 m<sup>3</sup>. The kieselguhr is conveyed pneumatically or with screw and vibrational conveyors.

#### 48.7.3.7 Environmental and Health Protection

Kieselguhr rarely contains toxic compounds. Since, however, it can contain crystalline modifications of SiO<sub>2</sub> in addition to amorphous silica, dust safety measures are of special significance. This is especially true of white activated kieselguhrs, which can contain up to 65% crystalline cristobalite. The MAK value for uncalcined kieselguhr is 4 mg/m<sup>3</sup> and for calcined kieselguhr, 0.3 mg/m<sup>3</sup>. The TLV for uncalcined kieselguhr is 10 mg/m<sup>3</sup>. The International Agency for Research on Cancer (IARC) published a monograph concerning crystalline silica in 1987 [546]. This summarizes the research results concerning the influence of crystalline silica on humans and concluded that apart from causing silicosis it may also cause cancer (see also Section 48.7.8). Hence, crystalline silica is classified in group 2A. As a result of this, the kieselguhr producers founded the International Diatomite Producers Association (IDPA), whose aims include informing personnel working in the kieselguhr industry and the consumer about these hazards, and to ensure adherence to the work protection regulations by increasing the information available [547, 548]. The regulations of individual countries concerning the handling of dusts containing crystalline silica differ widely:

*United States:* 29th Federal Statute book 1910.1000 from 19.01.89, which classifies crystalline silica as a hazardous substance and specifies tolerance levels.

*EC:* Directive 67/548/EEC from 18.09.79 concerning the classification, packaging, and labeling of hazardous substances.

*United Kingdom:* Control of substances which damage health No. 1857 from 1988.

*Germany:* UBG 119-4.86 Quartz: protection against dust dangerous to health; UBG 1004.85, rule G.1.1.: concerning the health precautions; GefStoffV 8.86: labeling regulations.

*France:* No. 50.1289 from 16. 10. 50 changed into No. 63576 from 11.06.63 concerning medical precautions against occupational silicosis. No. 11453 from 19.07.82 determines the dust concentration in the air of the work place. No. 87-200 from 25.03.87 regulates the content of safety data sheets for dangerous substances. L 231-6 from 10.10.83 lists dangerous substances and determines the packaging and labeling regulations.

*Spain:* from 27.11.85 classification and labeling of dangerous substances.

*Italy:* No. 256 from 29.05.74, No. 927 from 24.11.81, No. 141 from 20.02.88 concerning the classification, packaging, and information for hazardous materials.

#### 48.7.3.8 Uses

The main uses of kieselguhr are the following: 60% of world production is used as a filtration agent; ca. 25% as filler kieselguhrs, including carrier materials; and ca. 15% for other uses.

**Filtration Agents.** Kieselguhr is used in both pressure and vacuum filters of various designs. Fine, medium, and coarse kieselguhrs, as well as mixtures thereof, are employed, depending on the desired clarity and flow rate [549]. Coarse kieselguhrs are used for precoat filtration in pressure filters in amounts of ca. 1 kg/m<sup>2</sup> of filter area. Fine and medium kieselguhrs are added to the slurry to be filtered, usually in amounts of 100–200 g/m<sup>2</sup> filter area. For use as filter aids kieselguhrs must fulfil the following requirements:

- Good preservation of the diatom structure
- Optimal particle-size distribution

- Low content of soluble components
- High volume and therefore high capacity for materials causing turbidity

- Formation of filter cakes with high permeability, low compressibility, and low tendency to form cracks

The most important uses of kieselguhr are for the filtration of beer, wine, fruit juice, sugar cane juice, swimming pool water, solvents for chemical cleaning, wastewater, varnishes, and paints etc. Large quantities of kieselguhr are used for the production of cellulose-based filter beds, filter candles, and special filter papers.

**Fillers.** Kieselguhr is used as filler and auxiliary, for example, to modify the rheological properties of polymers. It increases the thermal stability of bitumen, the Shore A hardness of silicone rubber, and is a reinforcing filler in plastics, rubber, and adhesives. Dust-like, white, activated kieselguhr is used as a delustering agent, for adjusting the viscosity of paints, and as an antiblocking agent for plastic films.

**Insulators.** Loose kieselguhr has long been used for insulating double-walled kilns made from fireclay bricks, as well as for producing insulating sheets and bricks. Danish Moler is especially well suited for producing insulating bricks, since its clay content functions as a ceramic binder. The most recent development in the insulation sector is the VSI process (vacuum super insulation), in which a special form of kieselguhr acts as a supporting and insulating layer in double-walled elements that contain a high vacuum. Thus, extremely high insulation values are achieved. The VSI process is being tested for long-distance heat transport.

**Absorption Agents.** Due to their high capacity for liquids, kieselguhrs are used to produce gas purification agents as well as absorption agents such as cat litter and drying agents. Kieselguhr is also used to ensure the flowability and to prevent clotting of foodstuffs, fire extinguisher powders, and seeds.

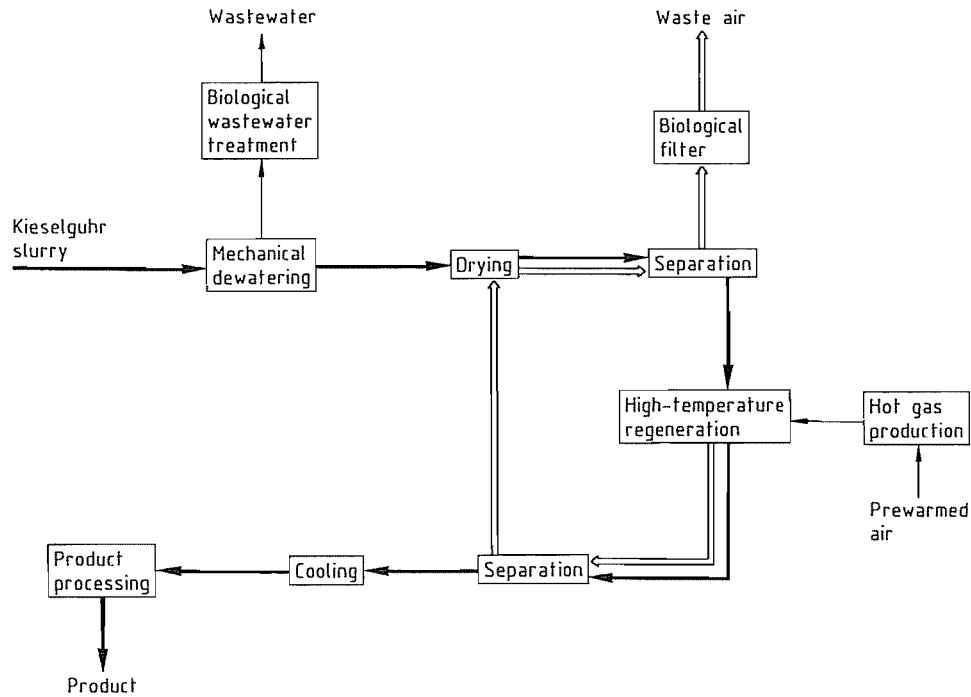

Figure 48.41: Flow sheet of thermal kieselguhr regeneration (Tremonis GmbH, Dortmund, Germany).

**Other Uses.** Kieselguhr serves as a fine scourer in polishes and cleaners such as car polishes, toothpastes, and silver polishes. Kieselguhr is employed as a catalyst support, for the production of pyrotechnics and matches, as a packing material for the transportation of hazardous liquids, and for the filling of acetylene bottles. In some countries it is used as the silica source for the production of cement and calcium silicate.

**48.7.3.9 Recycling**

Attempts to regenerate kieselguhr have been undertaken for many years [550]. This is only economically viable for kieselguhrs loaded with organic residues, which can be purified by leaching or calcination. In Germany, the company Tremonis operates a thermal process for recycling filter residues from breweries. The flow diagram of the plant is shown in Figure 48.41. The regenerated kie-

selguhr is classified as fine kieselguhr. It is added to the fresh kieselguhr for beer filtration in quantities of up to 50%.

**48.7.4 Colloidal Silica**

**48.7.4.1 Introduction**

Silica sols are stable disperse systems in which the dispersion medium (or continuous phase) is a liquid and the disperse or discontinuous phase is silicon dioxide in the colloidal state of subdivision. This state comprises particles with a size sufficiently small ( $< 1 \mu\text{m}$ ) not to appear affected by gravitational forces but sufficiently large ( $> 1 \text{nm}$ ) to show marked deviations from the properties of typical solutions.

The limits given for the colloidal size range are not rigid since they depend to some extent on the properties under consideration [551].

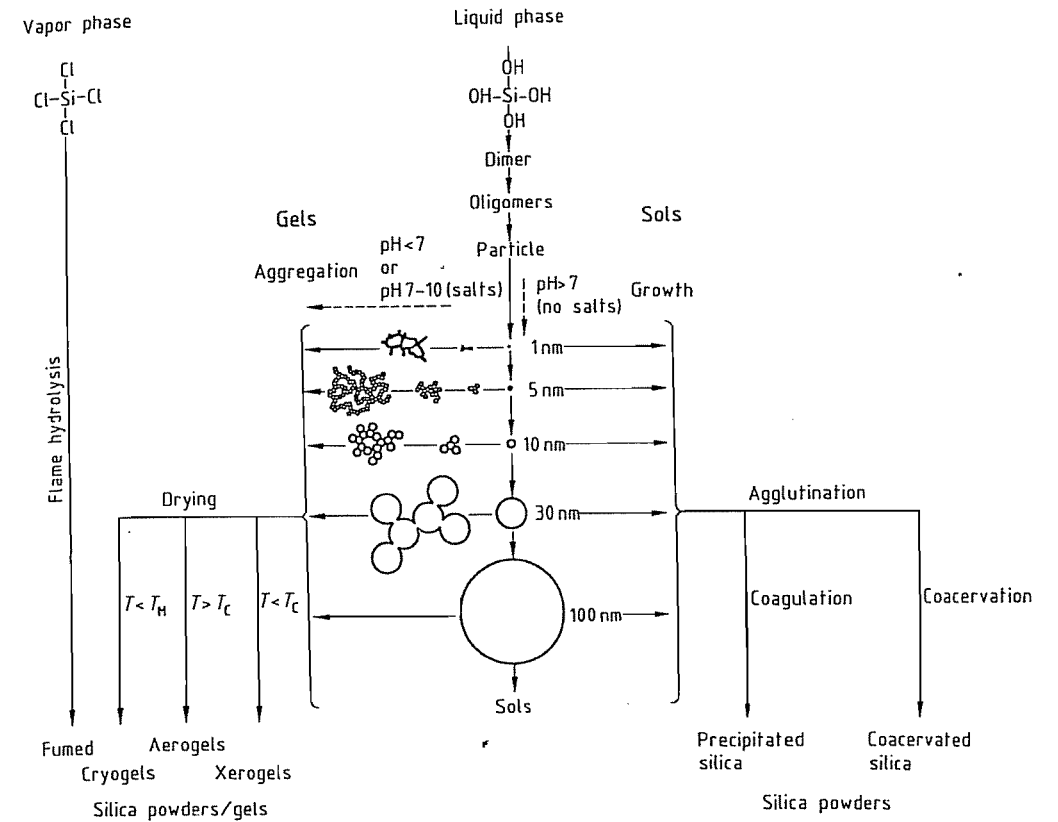

Figure 48.42: Formation of silica sols, gels, and powders by silica monomer condensation-polymerization followed by aggregation or agglutination and drying [552]. Growth of nascent colloidal particles with decrease in numbers occurs in basic solutions in the absence of salts. In acid solutions or in the presence of flocculating sols the colloidal silica particles form gels by aggregation into three-dimensional networks. Aerogels are made by drying wet gels under supercritical conditions, that is, above the critical temperature  $T_C$  and critical pressure of the liquid. Cryogels are made by drying wet gels below the melting temperature  $T_M$  of the liquid. Fumed or pyrogenic silicas are formed at high temperature by flame oxidation-hydrolysis of silicon halides.

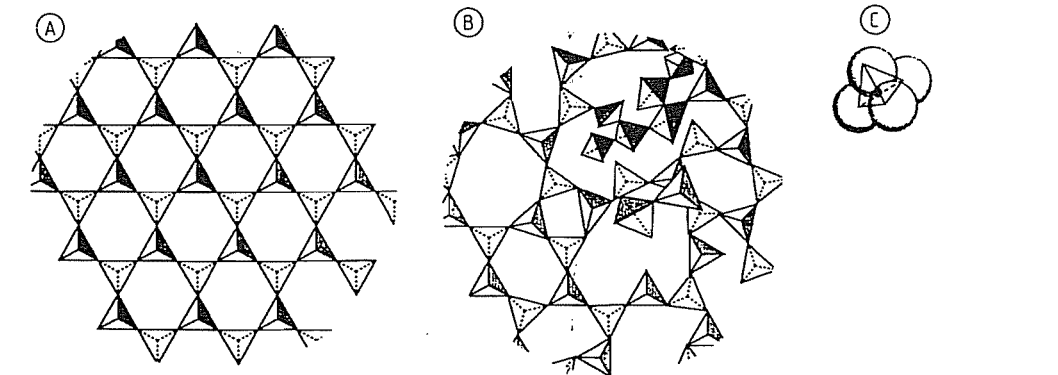

Figure 48.43: Tetrahedral configuration of crystalline (A) and amorphous (B) silica; (C) represents a silicon atom (filled circle) coordinated by four oxygen atoms (large atom spheres) [560].

Silica sols are commonly known as colloidal silica. Although the ultimate particles that constitute silica gels, xerogels, cryogels, aerosols, and pyrogenic (fumed), precipitated, and coacervated silica have lost their mobility by aggregation. They are also in the colloidal range of particle size and are therefore known as colloidal silicas. However, in this chapter the terms silica sol and colloidal silica are used as synonyms. Figure 48.42 illustrates the relationship between silica sols, gels, and powders [552].

In commercial silica sols the disperse silica is amorphous and the dispersion medium in most cases is water (aquesols or hydrosols). Dispersions in organic solvents are also commercially available (organosols). Silica sols are fluid and stable toward gelation and settling. Most commercial sols are close to monodisperse and consist of dense discrete spheres with a diameter range between ca. 4 or 5 nm and 100 nm. Also commercially available in the form of sols or powders are grades with particles between 0.1 and ca. 1.5  $\mu\text{m}$ . Particle size, particle-size distribution, and concentration of solids determine the appearance of sols. Silica sols look milky if the particle size is large and the concentration is high, opalescent if the size is intermediate, or clear and almost colorless if the particles are of the smallest size range.

Although there are earlier references to what are now known as silica sols, it was GRAHAM [553] who coined the term *colloidal* in 1862 to refer to products such as the one he obtained by reacting acid with silicate and removing the electrolytes by dialysis. Stable and relatively concentrated silica sols were not available until the 1930s when I. G. Farbenindustrie first made 10% ammonia-stabilized silica sols [554]. However, the real breakthrough in colloidal silica technology came in 1941 when BIRD [555] patented a process for removing the alkali from a dilute solution of sodium silicate by ion exchange. The next landmark in the development of concentrated silica sols was the first process for making colloidal silica particles of uniform and con-

trolled size reported in 1951 by BECHTOLD and SNYDER [556].

By 1990 colloidal silica constituted a growing market valued at an estimated  $\$50 \times 10^6$  in North America [557] and  $\text{DM } 30 \times 10^6$  in Europe [558]. Applications of silica sols are based on characteristics such as particle size, high specific surface area that gives them good binding ability, stability towards gelation and settling, and surface properties. These characteristics enable colloidal silica to be used in a wide variety of applications. Major uses are in investment casting, silicon-wafer polishing, and fibrous ceramics.

#### 48.7.4.2 Structure of Colloidal Silica Particles

The building block of silica is the  $\text{SiO}_4$  tetrahedron, four oxygen atoms at the corners of a regular tetrahedron with a silicon ion at the central cavity or centroid [559]. The oxygen ion is so much larger than the  $\text{Si}^{4+}$  ion that the four oxygens of a  $\text{SiO}_4$  unit are in mutual contact and the silicon ion is said to occupy a tetrahedral hole [559]. In amorphous silica the bulk structure is determined, as opposed to the crystalline silicas, by a random packing of  $[\text{SiO}_4]^{4-}$  units, which results in a nonperiodic structure (Figure 48.43). As a result of this structural difference amorphous silica has a lower density than the crystalline silicas: 2.2  $\text{g/cm}^3$  versus 3.01, 2.65, 2.26, and 2.21  $\text{g/cm}^3$  for coesite,  $\alpha$ -quartz,  $\beta$ -tridymite and  $\beta$ -cristobalite, respectively.

Figure 48.44 represents a two-dimensional random network of a dehydrated but fully hydroxylated amorphous silica particle.

Impurities such as Na, K, or Al, picked up during synthesis of silica aquesols in alkaline media, may be occluded inside the colloidal particles, replacing internal silanol protons (Na, K) or forming isomorphous tetrahedra (Al) with an additional negative charge on the surface or inside the particles (Figure 48.45). Sols obtained by hydrolysis of alkoxy silanes or by dispersion of pyrogenic silica in water or an organic solvent are pure and substantially free of alkali metals or aluminum.

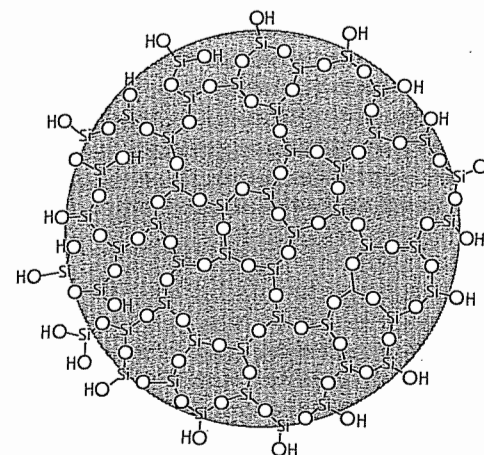

Figure 48.44: Two-dimensional random network of a dehydrated but hydroxylated colloidal silica particle. Four rules apply [561]: each oxygen ion is linked to no more than two silicon ions. The coordination number of oxygen ions about the central Si cation is 4 (the fourth oxygen not represented in the figure is directly above or below the Si cation). Oxygen tetrahedra share corners, not edges or faces. At least two corners of each tetrahedron are shared. Since the particle is fully hydroxylated each surface Si ion is bonded to one or two hydroxyl ions: the silanol number is 4.6  $\text{OH/nm}^2$ . Depending on the method of formation some internal Si ions may be linked to hydroxyl ions. Surface of occluded alkali-metal ion impurities may replace surface or internal protons. Aluminum ion impurities or added modifiers may replace internal or surface tetrahedral Si. The particle surface may be esterified, silanized (silylated), or ion exchanged. The concentration of OH groups on the surface decreases monotonically with increasing temperature when silica is calcined.

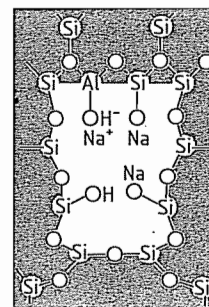

Figure 48.45: Internal structure of an amorphous silica particle showing an internal silanol group and occluded Na and Al ions.

Many of the adsorption, adhesion, chemical, and catalytic properties of colloidal silica depend on the chemistry and geometry of its surface. In 1934 HOFMAN [562] postulated the

existence of silanol ( $\text{Si-OH}$ ) groups on the silica surface. It is now generally accepted that surface silicon atoms tend to have a complete tetrahedral configuration and in an aqueous medium their free valence becomes saturated with hydroxyl groups forming silanol groups. Under appropriate conditions, silanol groups in turn may condense to form siloxane bridges:  $\equiv\text{Si-O-Si}\equiv$ .

In the meantime most of the following postulated groups have been identified on the surface or in the internal structure of amorphous silica (Figure 48.46).

- Single silanol groups, also called isolated or free silanol groups
- Silanediol groups, also called geminal silanols
- Silanetriols, postulated but existence not yet generally accepted [563]
- Hydrogen-bonded vicinal silanols (single or geminal), including terminal groups
- Internal silanol groups involving OH groups, sometimes classified as structurally bound water (Figure 48.46B)
- Strained and stable siloxane bridges
- Physically adsorbed  $\text{H}_2\text{O}$ , hydrogen-bonded to all types of surface silanol groups (Figure 48.46B)

Silanol groups are formed on the silica surface in the course of its synthesis during the condensation polymerization of  $\text{Si}(\text{OH})_4$  or by rehydroxylation of thermally dehydroxylated silica with water or aqueous solutions.

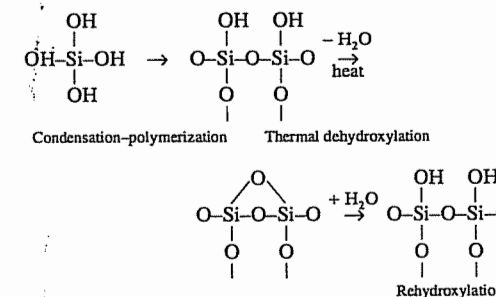

The silanol groups on the silica surface may be classified according to their nature, multiplicity of sites, and type of association [564].

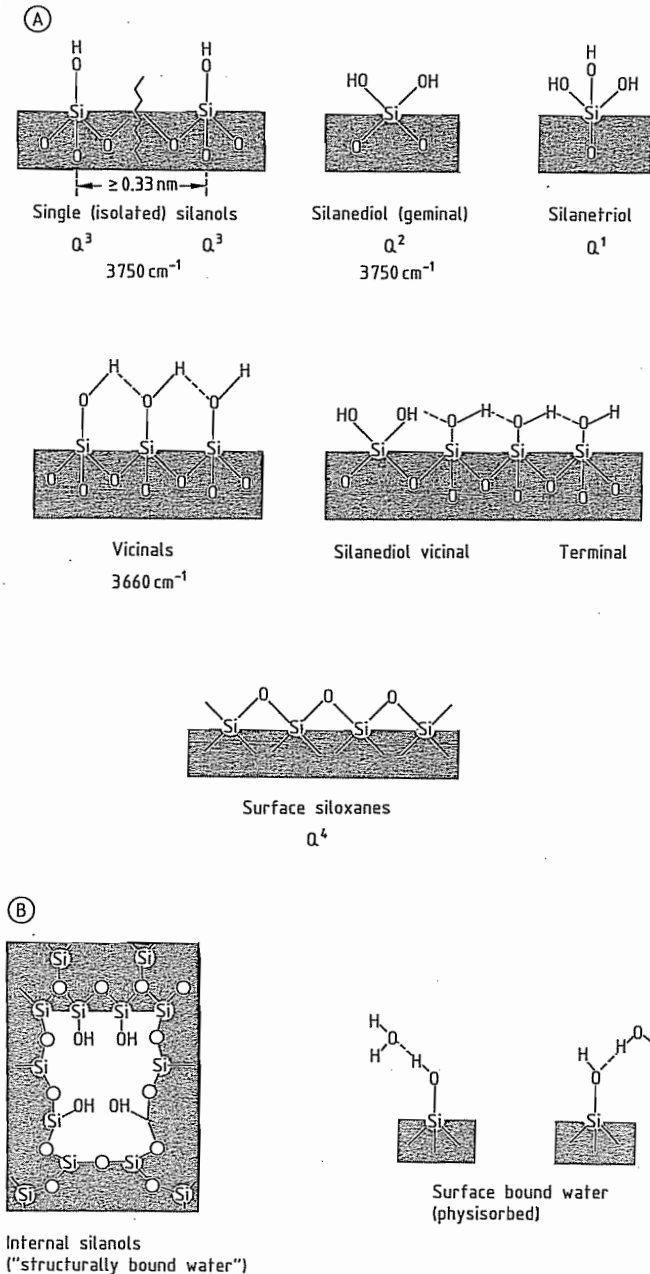

**Figure 48.46:** A) Possible types of silanol groups and siloxane bridges occurring on the surface of colloidal silica particles. Characteristic bands in the infrared spectrum and  $Q^n$  site designation is included ( $n$  is the number of bridging oxygens bonded to the central silicon atom); B) Surface bound water and internal silanols.

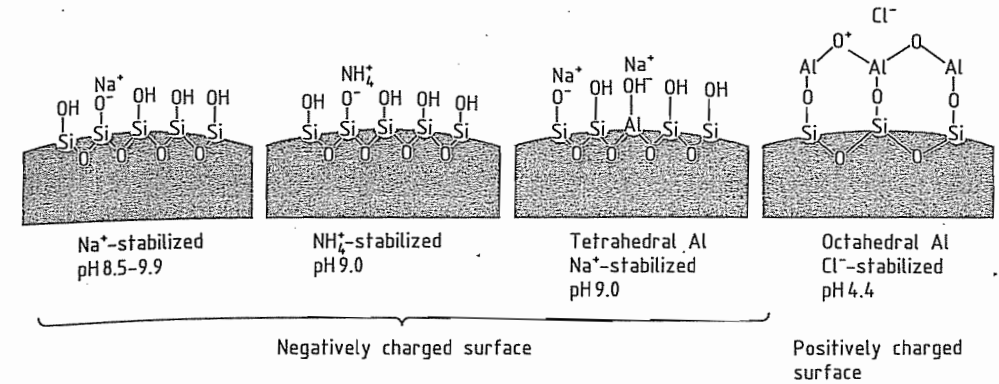

**Figure 48.47:** Modified colloidal silica surface.

An isolated silanol has an OH group sufficiently remote from neighboring hydroxyl groups that hydrogen bonding cannot occur ( $\geq 0.33\text{ nm}$ ). A silicon site of this kind is designated as  $Q^3$  in NMR  $Q^n$  terminology, where  $n$  is the number of bridging oxygens bonded to the central silicon. The isolated silanol shows a sharp band at around  $3750\text{ cm}^{-1}$  in the IR spectrum [565, 566].

Geminal silanols are silanediol groups located on  $Q^2$  silicon sites. Their existence was postulated by PERI [565-567] but only confirmed experimentally with the advent of solid-state <sup>29</sup>Si cross-polarization magic angle spinning nuclear magnetic resonance (CP MAS NMR) [568].

Vicinal or hydrogen-bonded or associated silanols are SiOH groups located on neighboring Si atoms such that the OH...O distance is sufficiently short for hydrogen bonding to occur. Hydrogen bonding causes a reduction in the O-H stretching frequency, the magnitude of which depends on the strength of the hydrogen bond and thus on the O-H...O distance [569]. The characteristic IR band of vicinal groups occurs at about  $3660\text{ cm}^{-1}$  [570].

Geminal  $Q^2$  silanol sites bonded to a neighboring  $Q^3$  silicon through a single siloxane bridge also result in a hydrogen-bonded pair. The remaining OH group experiences very weak hydrogen bonding.

Silanol groups are also found within the structure of the colloidal particles. These groups are designated as internal silanols and

in some cases are erroneously referred to as structurally bound water. The concentration of internal silanol groups depends on the synthesis temperature and other variables.

Surface and internal silanol groups may condense to form siloxane bridges. Strained siloxane bridges are formed on the hydroxylated silica surface by thermally induced condensation of hydroxyl groups up to about  $500\text{ }^\circ\text{C}$ . At higher temperature, the strained siloxane bridges are converted into stable siloxane bridges [569].

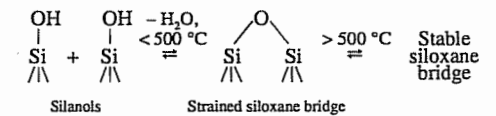

Strained siloxane groups undergo complete rehydroxylation on exposure to water in a matter of hours or a few days, depending on type of silica powder and conditions of exposure [570]. Stable siloxane groups are rehydroxylated at a slower rate. For example, a wide-pore sample of  $340\text{ m}^2/\text{g}$  calcined in air at  $900\text{ }^\circ\text{C}$  required five years of contact with water at room temperature for complete rehydroxylation [571].

Surface silanol groups are the main centers of adsorption of water molecules [571]. Water can associate by hydrogen bonding with all types of surface silanols, and in some cases with internal silanol groups.

Surface silanol groups of silica aquasols stabilized in an alkaline medium exchange

protons for ions such as  $\text{Na}^+$ ,  $\text{K}^+$ , or  $\text{NH}_4^+$  (Figure 48.47). The surface silanol groups can be esterified, as in the case of silica organosols, or silylated (silylated) (Figure 48.48). Derivatization, that is modification of the silica surface, is the basis for the use of silica in analytical and process chromatography.

The surface charge of pure silica aquasols is negative at a pH higher than ca. 3. The isoelectric point (IEP) is ca. 2. The IEP can be shifted by partial substitution of surface silicon groups by tetrahedral aluminum (Figure 48.47). In this way the pH range of stability of aquasols may be varied. The surface charge can be reversed by adsorption of octahedral aluminum ions such as those present in basic aluminum chloride [572] (Figure 48.47). Aquasols obtained in this manner are commercially available in various particle sizes and concentrations as *positive sols*.

The concentration of silanol groups on the silica surface  $\alpha_{\text{OH}}$  expressed as the number of OH groups per square nanometer is the silanol number [571]. For a dehydrated but fully hydroxylated amorphous colloidal silica powder  $\alpha_{\text{OH}}$  is 4.6 [571].

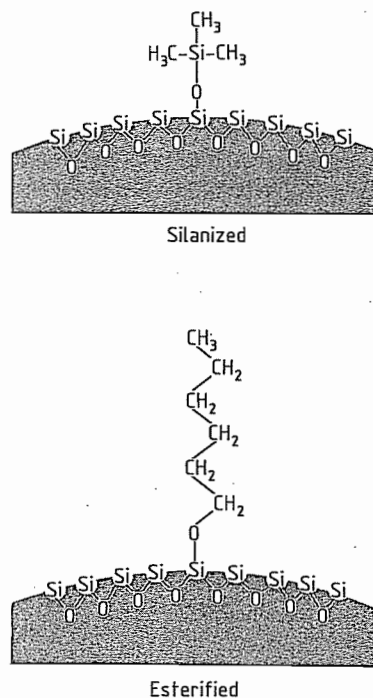

Figure 48.48: Silylated and esterified silica surface.

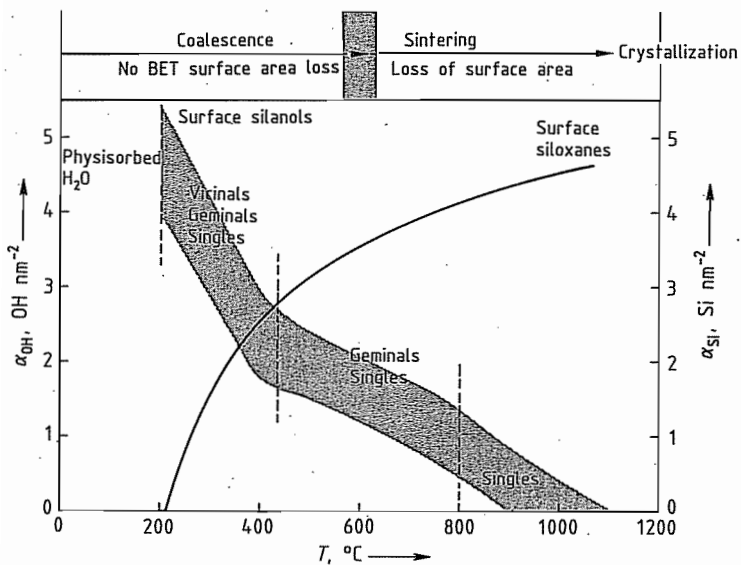

Figure 48.49: Effect of temperature on silanol groups on the surface of colloidal silica.

The threshold temperature corresponding to the completion of dehydration, that is removal of physisorbed water from the silica surface, and the beginning of dehydroxylation by condensation of surface OH groups, is estimated to be  $190 \pm 10^\circ\text{C}$  [571].

The concentration of OH groups on the surface decreases monotonically with increasing temperature when silicas are heated under vacuum (Figure 48.49). Most of the physisorbed water is removed at about  $150^\circ\text{C}$ . At  $200^\circ\text{C}$  all the water from the surface is gone so that the surface consists of single, geminal, vicinal, and terminal silanol groups and siloxane bridges. At ca.  $450\text{--}500^\circ\text{C}$  all the vicinal groups condense yielding water vapor and only single, geminal, and terminal silanol groups and strained siloxane bridges remain. The estimated ratio of single to geminal silanol groups on the surface is 85/15 [571] and is believed not to change with temperature, at least up to ca.  $800^\circ\text{C}$ . Internal silanols begin to condense at ca.  $600\text{--}800^\circ\text{C}$  and in some cases at lower temperatures. Complete evolution of internal silanols occurs at higher temperatures. It appears that at temperatures from ca.  $800^\circ\text{C}$  to ca.  $1000\text{--}1100^\circ\text{C}$ , only isolated (single) silanol groups remain on the silica surface.

At a sufficient surface concentration, the OH groups make the silica surface hydrophilic, whereas a predominance of siloxane groups on the silica surface makes the surface hydrophobic.

#### 48.7.4.3 Physical and Chemical Properties

Most commercial silica sols consist of dense, discrete, spheroidal particles typically  $4\text{--}60\text{ nm}$  in diameter and amorphous to X-ray or electron diffraction. Because they are amorphous the silica particles are only slightly sol-

uble in water ( $100\text{--}150\text{ ppm}$  at  $25^\circ\text{C}$  and pH 2–8) and insoluble in alcohol or in inorganic acids except HF. They are soluble in organic bases such as tetramethylammonium hydroxide, forming water-soluble quaternary ammonium silicates, and, as opposed to crystalline silicas, are very soluble in hot sodium hydroxide solution. Specific surface areas vary with particle size, and for the common grades of silica sols are between  $50$  and  $750\text{ m}^2/\text{g}$ . Less typical grades have particle diameters between  $60\text{ nm}$  and  $1.5\text{ }\mu\text{m}$  with specific surface areas much lower than  $50\text{ m}^2/\text{g}$ , depending on their particle diameter. The specific surface area  $A$  in  $\text{m}^2/\text{g}$  of a system made of solid monodisperse amorphous silica spheres with a smooth surface and bulk density  $2.2\text{ g/cm}^3$  is:

$$A = 6000D/2.2$$

where  $D$  is the diameter of the spheres in nanometers.

Table 48.20 lists typical properties of representative commercial silica aquasols. The table also shows the dependence of relative density and viscosity on the silica content. Viscosity also depends on particle size and degree of cross-linking of the particles. In 30% silica aquasols it is generally  $< 10\text{ mPa}\cdot\text{s}$ .

Silica sols obtained by dispersion of pyrogenic silica powders generally differ from those synthesized in solution. The dispersion of pyrogenic silica to a sol of separate, discrete ultimate units is difficult, even using intense mechanical shearing forces, due to the extensive coalescence of the particles. Thus, the disperse product consists mainly of short chain-like aggregates made up of small silica particles. Typical properties of commercial sols made in this way are listed in Table 48.21.

Table 48.22 lists particle size, silica concentration, and viscosity of commercially available organosols.

**Table 48.20:** Typical properties of commercially available negative and positive silica aquasols (NA = not available) [573].

|  | Particle diameter, nm | Specific surface area, m <sup>2</sup> /g | Silica, % | pH   | Na <sub>2</sub> O, % | Viscosity at 25 °C, mPa·s | Relative density at 25 °C |
|--|-----------------------|--|-----------|------|----------------------|---------------------------|---------------------------|
| Negatively charged surface sodium stabilized                   | 4                     | 750                                      | 15        | 10.4 | 0.80                 | 18                        | 1.10                      |
|  | 7                     | 360                                      | 30        | 9.9  | 0.56                 | 6                         | 1.22                      |
|  | 12                    | 230                                      | 40        | 9.7  | 0.41                 | 20                        | 1.31                      |
|  | 21                    | 130                                      | 50        | 9.0  | 0.21                 | 35                        | 1.40                      |
|  | 60                    | 50                                       | 50        | 8.5  | 0.25                 | 10                        | 1.40                      |
|  | 50–80                 | NA                                       | 40        | 9–10 | NA                   | NA                        | NA                        |
|  | 70–100                | NA                                       | 40        | 9–10 | NA                   | NA                        | NA                        |
|  | 100                   | NA                                       | 20        | 9–10 | NA                   | NA                        | NA                        |
|  | 300                   | NA                                       | 20        | 9–10 | NA                   | NA                        | NA                        |
|  | 500                   | NA                                       | 20        | 9–10 | NA                   | NA                        | NA                        |
| alumina modified surface ammonium stabilized                   | 12                    | 230                                      | 30        | 8.9  | 0.24                 | 11                        | 1.21                      |
|  | 21                    | 130                                      | 40        | 9.0  | 0.08                 | 9                         | 1.30                      |
| Positively charged surface chloride stabilized alumina surface | 13–15                 | 210                                      | 30        | 4.4  | NA                   | NA                        | NA                        |

**Table 48.21:** Typical properties of silica aquasols made of short chain-like aggregates of colloidal particles (NA = not available) [574].

| Stabilizer                   | Ultimate particle size, nm | Solids, % | pH        | Relative density | Viscosity, mPa·s |
|------------------------------|----------------------------|-----------|-----------|------------------|------------------|
| NH <sub>4</sub> <sup>+</sup> | 7                          | 12        | 7.5–7.8   | 1.07             | < 100            |
|                              | 14                         | 17        | 9.5–10.0  | 1.10             | < 250            |
|                              | 14                         | 12        | 5.0–5.5   | 1.07             | < 100            |
|                              | 17                         | 17        | 9.5–10.0  | 1.10             | < 100            |
|                              | 30                         | 20        | 5.0–5.5   | 1.12             | < 100            |
| K <sup>+</sup>               | 17                         | 18        | 8.6–9.0   | 1.11             | < 150            |
|                              | 30                         | 28        | 7.5–7.8   | 1.18             | < 200            |
|                              | 30                         | 30        | 10.0–10.3 | 1.19             | < 150            |
| Na <sup>+</sup>              | 7                          | 14        | 10.0–10.5 | 1.08             | < 100            |
|                              | 8                          | 15        | 9.5–10.0  | 1.09             | < 100            |
|                              | 14                         | 17        | 9.5–10.0  | 1.10             | < 100            |
| Acidic medium                | 11–14                      | 20        | 2.0–4.0   | NA               | 5–25             |

**Table 48.22:** Properties of commercially available silica organosols (NA = not available) [575].

| Liquid phase                              | Particle diameter, μm | SiO <sub>2</sub> , % | Viscosity at 25 °C, cP | Relative density |
|---|-----------------------|----------------------|------------------------|------------------|
| Methanol                                  | 0.01                  | 30                   | 1–5                    | NA               |
| 2-Propanol                                | 0.01                  | 30                   | 3–20                   | NA               |
| Water/2-propanol                          | 0.02                  | 30                   | 10                     | NA               |
| Ethylene glycol mono- <i>n</i> -polyether | 0.01                  | 20                   | 5–20                   | NA               |
| Dimethylacetamide                         | 0.01                  | 20                   | 1–10                   | NA               |
| Ethylene glycol                           | 0.01                  | 20                   | 10–20                  | 1.23             |
|   | 0.18 ± 0.03           | 20                   |                        | 1.23             |
| DMF                                       | 0.02                  | 35                   | 5                      | NA               |
| Oil                                       | 0.02                  | 50                   | 80                     | NA               |
| Ethylene glycol                           | 0.28 ± 0.03           | 20                   |                        | 1.23             |
|   | 0.43 ± 0.03           | 20                   |                        | 1.23             |
|   | 0.50                  | 20                   | 10–20                  | 1.23             |
|   | 0.53 ± 0.03           | 20                   |                        | 1.23             |
|   | 0.73 ± 0.03           | 20                   |                        | 1.23             |
|   | 0.80 ± 0.04           | 20                   |                        | 1.23             |
|   | 0.90 ± 0.05           | 20                   |                        | 1.23             |
|   | 1.50 ± 0.10           | 20                   |                        | 1.23             |

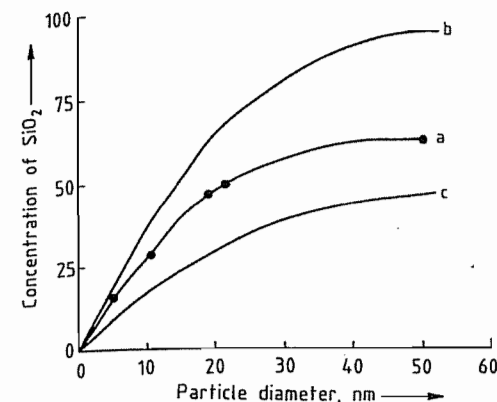
**Figure 48.50:** Maximum concentration versus particle size in stable aqueous silica sols at about pH 9.5: a) Concentration in %; b) Concentration in grams SiO<sub>2</sub> per 100 mL; c) Volume fraction of SiO<sub>2</sub> (× 100) [576].

Silica sols are said to be stable because they do not settle or aggregate for long periods of time. Aggregation and rate of settling, as well as color, appearance, viscosity, density, growth, and solubility in water are functions of particle size. At optimum pH, electrolyte and SiO<sub>2</sub> concentration, aquasols of particle size 4 to ca. 40 nm are extremely stable to settling, whereas aquasols of particle size larger than ca. 60 nm tend to show some settling in a period of months. Particles larger than 100 nm settle on standing, leaving a clear upper layer after a few weeks or days. When the concentration of the silica aquasol is > 10–15% the particle size can be judged visually by the turbidity. If the particles are smaller than ca. 7 nm in diameter the sol is almost as clear as water; from 10–30 nm there is a characteristic opalescence or translucency when seen in bulk; above 40 or 50 nm the appearance is white and milky [554].

Commercial silica aquasols are stabilized near the optimum pH and are concentrated to the maximum concentration permitted by the particle size [576]: ca. 15% for 4–5 nm, ca. 30% for 8–9 nm, ca. 40% for 14 nm, ca. 50% for 22 nm (Figure 48.50).

When silica sols are gelled, dried, or frozen the original degree of dispersion cannot be restored without dissolution of the interparticle bonds that develop. Special dried grades are

made of particles with the surface esterified with primary or secondary C<sub>2</sub>–C<sub>18</sub> alkoxy groups. These are organophilic and hydrophobic and can be dispersed in organic solvents or in organic products such as elastomers or plastics. Silica sols surface-modified with organic base cations such as (CH<sub>3</sub>)<sub>4</sub>N<sup>+</sup> can be evaporated to a dry powder that disperses spontaneously in water [577].

#### 48.7.4.4 Stability

Three types of stability may be distinguished in colloidal systems [578]:

- Phase stability, analogous to the phase stability of ordinary solutions.
- Stability to change in *dispersity* [578], that is particle size or particle-size distribution. For example, commercial concentrated silica sols, normally said to be 3 or 4 nm in particle size usually grow within hours or a few days to 5 nm or more on standing at room temperature. Concentrated sols normally labeled 7 nm, if not substantially homodisperse, may grow within months to 8–9 nm. This ripening effect also occurs for larger particle sizes, although at a much slower rate. A concentrated silica sol of 14 nm particle size was found to grow to 17 nm in twenty years at room temperature [579].
- *Aggregative stability* [578], the central issue in colloidal silicas, and for that matter in colloidal systems in general. In this case *colloidally stable* means that the colloidal particles do not aggregate at a significant rate [551]. The term aggregate is used to describe the structure formed by the cohesion of colloidal particles [551].

Two mechanisms of sol stabilization are generally believed to exist: electrostatic stabilization and steric stabilization. Electrostatic stabilization is based on an interplay of electrostatic repulsion between electrically charged colloidal particles and van der Waals forces of attraction between particles. The DLVO theory (Derjaguin, Landau, Verwey, and Overbeek) constitutes an attempt to describe quantitatively this interplay. Steric sta-



bilization is generally caused by long-chain molecules or macromolecules adhering on the colloidal particle surface (e.g., by grafting or by physical adsorption), thus preventing the particles from aggregating [580].

Colloidal silica particles aggregate by linking together and forming three-dimensional networks as is the case in gelation, coagulation or flocculation, or by coacervation [581]. In coacervation the silica particles are surrounded by an adsorbed layer of material which makes the particles less hydrophilic but does not form bridges between particles [582].

When a sol is gelled it first becomes viscous and then develops rigidity, filling the volume originally occupied by the sol. On the other hand when a sol is coagulated or flocculated, a precipitate is formed that settles out. A simple way to differentiate between a precipitate and a gel is that a precipitate encloses only part of the liquid in which it is formed [581].

Stability of silica aquasols against irreversible gelation decreases with increasing silica concentration, increasing electrolyte concentration of the aqueous medium, decreasing particle size, and increasing temperature. Water-miscible organic liquids have a similar destabilizing effect on silica aquasols as added electrolyte. The variation of stability as a function of pH and salt concentration is shown in Figure 48.51 [583].

According to ILER [584] the basic step in gel formation is the collision of two silica particles with sufficiently low charge on the surface that they come into contact so that siloxane bonds are formed, holding the particles irreversibly together. Formation of this linkage requires the catalytic action of hydroxyl ions (or, as interpreted by some, the dehydration of the surface of particles at higher pH). This is evidenced by the fact that the rate of gel formation in the pH range 3–5 increases with pH and is proportional to the hydroxyl concentration.

Above pH 6, scarcity of hydroxyl ions is no longer the limiting factor on the rate of gel-

ling. Instead, the rate of aggregation decreases because of fewer collisions between particles owing to the increasing charge on the particles and thus decreases with higher pH. Lines in Figure 48.51 schematically represent the increase in the catalytic effects of hydroxyl ions with increasing pH, and the decrease in the number of effective collisions between particles with increasing pH and particle charge. The net result of these two effects is a maximum in rate of gelling at around pH 5. In the pH range 8–10, sols are generally stable in the absence of salts.

There is also a region of temporary stability at about pH 1.5. Below pH 1.5, traces of HF catalyze aggregation and gelling [585]. In essentially all silicas, traces of fluoride ions, even less than 1 ppm, are present so that the concentration of HF increases with increasing acidity. The fluoride effect is influenced by the aluminum impurities present, since these inactivate some of the fluoride by forming complex ions such as  $AlF_6^{3-}$  and other species [586]. However, the gelling rate increases as the pH falls below 3 even when fluorine is absent.

Once the siloxane bonds have formed between particles, further deposition of silica occurs at the point of contact owing to the negative radius of curvature. This occurs rapidly above pH 5, and is slow at pH 1.5.

Since the curves shown in Figure 48.51 are constructed on the basis of irrefutable experimental evidence it is quite obvious that silica sols do not conform to the DLVO theory as originally formulated. For example, the DLVO theory predicts minimum stability at the point of zero charge (pH 2–3), whereas the experimental curve shows metastability. Also, the plot shows minimum stability in the pH range 4–7, whereas the DLVO theory predicts a continuous increase in stability in this pH range. Research is being conducted to study the possibility of modifying or amending the DLVO theory or developing a new theory of stability applicable to silica sols.

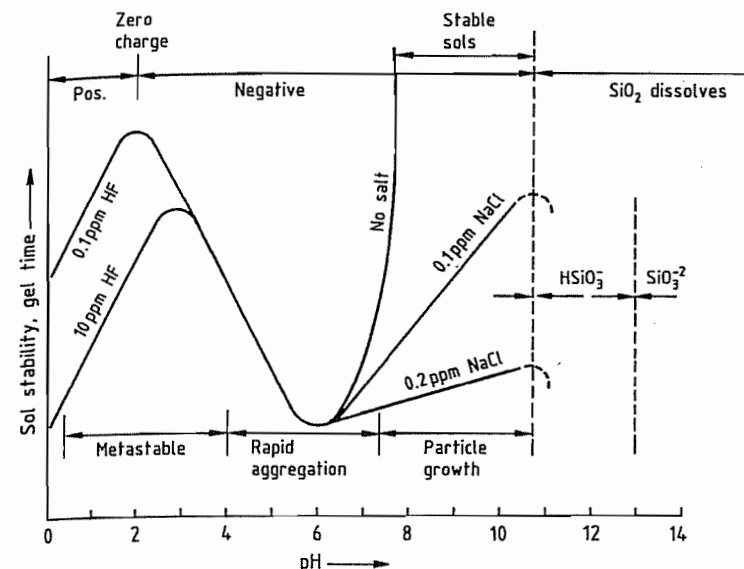

Figure 48.51: Effect of pH in the colloidal silica-water system [577].

In addition to common electrolytes such as NaCl,  $NH_4Cl$ , and KF, silica aquasols are destabilized and gelled by positively charged sols. When frozen at ca. 0 °C or lower, silica sols gel irreversibly. Long-chain nitrogen bases are effective flocculating agents for silica aquasols that form planar rather than spheroidal aggregates. Flocculation may also result from the addition of water-miscible organic solvents to alkali-stabilized-silica sols.

Commercial silica aquasols are stabilized at pH 8.5–10.5 by alkalis, usually sodium hydroxide. Ammonia or potassium hydroxide is used when the presence of sodium ions is undesirable.

Surface-modified silica aquasols made by coating the silica particles with tetrahedral aluminum (e.g., sodium aluminate) are much more stable towards gelling in the pH range 4–6 where unmodified sols gel most rapidly. Silica sols modified in this manner are also less sensitive to salts [587].

Coating the negative silica surface with oxides of polyvalent metals such as Al, Cr, Ga, Ti, and Zr reverses the charge of the surface to produce positive aquasols stable at acid pH values [588]. An important characteristic of these sols is that they can be dried and reprep-

ared. Only polymeric hydrolyzed species such as  $Al_2(OH)_5Cl$  and not the single  $Al^{3+}$  ion can cause charge reversal of silica sols [589, 590].

#### 48.7.4.5 Production

The classic silica aquasols of particle size 5–100 nm are prepared by nucleation, polymerization, and growth in aqueous systems. The particle-size range can be extended to at least 300 nm by autoclaving. Silica organosols can be obtained by transferring aquasols to an organic solvent or by hydrolysis of a silane precursor in a mixture of alcohol/ammonia and sufficient water [591] followed by transfer to the solvent.

The most important processes to make silica sols are based on neutralization of soluble silicates with acids, ion exchange, hydrolysis of silicon compounds, dispersion of pyrogenic silica, electro dialysis, dissolution of elemental silicon and peptization of gels [592].

Currently, most commercial silica sols are prepared by ion exchange of dilute solutions of sodium silicate. Several methods have been proposed since the pioneering work of BIRD [555], BECHTOLD and SNYDER [556], ALEX-

ANDER [593], ATKINS [594], WOLTER and ILER [595], MINDICK and REVEN [596], and DIRNBERGER [597]. Sodium silicate can be deionized in a batch operation by adding simultaneously a dilute solution of sodium silicate and a cationic ion-exchange resin in the hydrogen form to a vigorously stirred weakly alkaline aqueous reaction medium in the pH range around 9, at 60–100 °C [595] (Figure 48.52). Under these conditions the system is stabilized against aggregation and the original silica nuclei grow while the sol concentration increases to about 10–15% silica. Rate of addition, pH, and temperature determine the particle size and quality of the sol.

After separation of the resin for regeneration, more sodium silicate is added to adjust the  $\text{SiO}_2/\text{Na}_2\text{O}$  ratio as needed for further stabilization of the sol. The product is filtered and concentrated to the desired level. Sols of small particle size, such as 7 nm, may be used as “heels” to build up the particle size, for example, to 14 or 22 nm.

An alternative method of deionizing sodium silicate is to pass a relatively dilute solution through a bed of ion-exchange resin to produce a sol which is then stabilized with alkali and concentrated. The particles grow during evaporation. The addition of further deionized sol to the evaporating liquid allows

silica to build up on previously nucleated particles resulting in larger particle size.

Silica sols can also be made by dispersion of pyrogenic silica in water or in an organic solvent. Commercial pyrogenic silica, also known as fumed silica or aerosil, is made from silicon tetrachloride at high temperatures by a flame hydrolysis–oxidation process (see Section 48.7.6) [598]. The product is a highly aggregated silica powder. Pyrogenic silicas can be partially disaggregated and dispersed to obtain aquasols or organosols of relatively high silica concentration. The silica units in this case consist mainly of short chain-like aggregates composed of silica particles ca. 7–25 nm in diameter.

Monodisperse silica sols of exceptionally large particle size can be prepared by hydrolysis of tetraethoxysilane (TEOS) in a basic solution of water and alcohol [591]. It is claimed that the largest mean particle size that can be produced with TEOS is about 0.8  $\mu\text{m}$  [599]. However, particles up to ca. 2  $\mu\text{m}$  can be made by using tetrapentoxysilane [598], performing the reaction at low temperature [600], or growing the particles by adding more alkoxide after the particles have formed [600]. WOLF [601] has adapted the TEOS method to produce commercial quantities of silica sols.

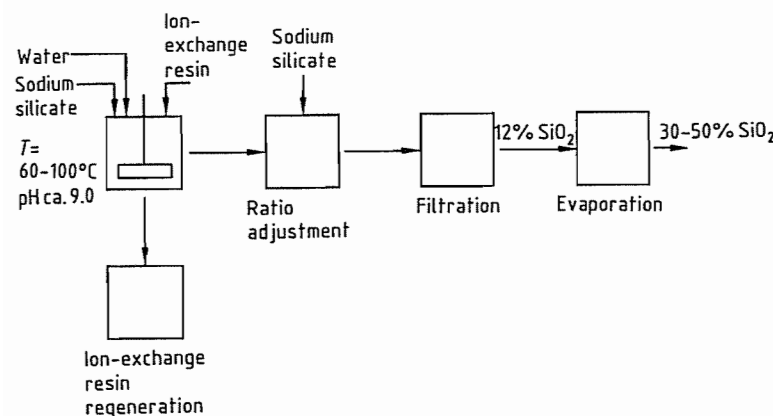

Figure 48.52: Ion-exchange process for silica aquasols.

Viable processes for making commercial silica sols are based on the electro dialysis of sodium silicate solutions to continuously remove sodium ions until a sol is obtained. In the ILER [602] and the BERGNA [603] processes there are three compartments separated by two parallel, closely spaced cation-exchange membranes between which the process or “heel” solutions of silica sol in dilute  $\text{Na}_2\text{SO}_4$  as a conducting electrolyte are rapidly circulated at a specified temperature. Sulfuric acid is circulated in the anode compartment and an alkali in the cathode compartment where sodium hydroxide is generated. Dilute sodium silicate is fed to the third compartment to form  $\text{SiO}_2$  by electrolysis. The silica or polysilicic acid that forms is deposited on the silica particles of the “heel” solution, and circulation of the solution is continued until the desired particle size is achieved. Sols of 25% silica, 15 nm particle-size can be prepared directly. Concentrated sols of ca. 8 nm particle size with very narrow particle-size distribution can be obtained by seeding in a first step at a lower temperature and raising the temperature in a second step to accelerate silica deposition [603].

Among the advantages of the electro dialysis process are that alkali, oxygen, and hydrogen can be recovered, and that there is much less salt-containing wastewater to be disposed of. The disadvantages of the process are higher electrical and maintenance costs.

#### 48.7.4.6 Analysis and Characterization

Characterization of silica sols is aimed at identifying:

- Physical and chemical properties of the sol
- Compatibility and stability properties of the sol
- Purity of the sol
- Use-related characteristics

Selection of silica sols for commercial uses is commonly based on the nature of the liquid phase (water or organic solvent), particle size, particle-size distribution, degree of aggrega-

tion, pH, silica and counterion (stabilizing agent) concentration, viscosity, relative density, and specific surface area.

However, to fully understand and predict the behavior of silica sols and derived powders, it is necessary to determine other characteristics such as particle and particle surface structure; chemical composition including total carbon, organic carbon, soluble salts of alkali metals, total solids, nonsiliceous ash; and trace metals (especially Al and Fe); and physical properties such as turbidity, percent S (the percent by weight of silica in the dispersed phase of a silica sol [604]), refractive index, light scattering, sedimentation rate by ultracentrifugation, porosity, rate of dissolution of the particles, and coalescence factor of derived powders (the coalescence factor is the percent silica that must be dissolved to restore the light transmission under standard conditions of a silica powder redispersed in water [605]). In addition, most manufacturers of colloidal silicas use special tests for specific uses.

A new concept in the characterization of colloidal silica is the application of the fractal approach to sols and gels. The concept of fractal geometry, developed by MANDELBROT [606] in the early eighties, provides a way of quantitatively describing the average structure of certain random objects. For the application of the fractal concept to colloidal silica, see [560, 569].

#### 48.7.4.7 Uses

This section gives a brief description of the major industrial uses of silica sols. The many minor uses are too numerous to be discussed here.

Colloidal silica is widely used as a binder in the modern version of the ancient lost wax process for casting metal [612]. In this process, known as *shell investment casting*, a wax original or a cluster of originals is dipped in a slurry of colloidal silica and refractory powder. Excess slurry is drained from the wax parts, and a dry refractory sand is applied to the wet surface. The coating is then allowed to dry. These coating steps are repeated until a

ceramic shell of sufficient thickness, usually about 5–10 mm, is built up around the wax.

The wax is then melted out, and the ceramic shell fired to increase its strength and to remove the last traces of wax. Molten metal is poured into the hollow left by the wax. When the metal has cooled, the shell is broken away and the metal, now an exact replica of the original wax shape, is recovered.

This process is widely used to produce jet engine components as well as a large number of other metal parts. The tolerances of the finished casting can be held very close to the final requirements, thus minimizing the need for additional finishing operations.

Refractory fibers can be bonded with colloidal silica to give *insulators* that have excellent high-temperature resistance. The process is similar to papermaking in that the fibers are suspended in water and the mixture passed through a screen which retains the fibers and allows the water to pass through and be recycled. The thickness of the fiber mat can vary from 0.1–10 cm depending on the insulating properties required. The screen is often contoured to give a shaped insulator. Usually, vacuum is used to assist the flow of water through the screen.

Colloidal silica is used two ways in this process. It is often used in small quantities together with starch in the original fiber suspension to help flocculate the fibers and the starch for better drainage and retention on the screen. The starch acts as the binder in the unfired or green state. Additional colloidal silica is often added to the final shape to stiffen and strengthen it and provide additional strength when the part is heated and the starch is burned out.

More recently, colloidal silica has been applied to the *papermaking* process itself. By adding small amounts of high surface area colloidal silica and a high molecular mass starch to the paper pulp, drainage rates and fiber and filler retention are improved. This allows for higher filler loadings, use of more recycled pulp, and in some cases, higher production rates [613–617].

Small amounts of colloidal silica increase the coefficient of friction of surfaces. One of the earliest uses of colloidal silica was to diminish the slipperiness of floor waxes while not affecting their gloss [618, 619]. It is widely used today to improve the frictional character of paper and boxboard, which facilitates handling and reduces breakage resulting from falling boxes [620].

Carpets and other surfaces coated with colloidal silica resist soiling because the colloidal silica occupies the sites which would most likely retain visible soil.

The strength and adhesion of latex-based adhesives and paints can be enhanced by the addition of colloidal silica.

Silicon wafers cut from silicon single crystals must be polished to an almost atomically smooth surface before being used as substrates for electronic chips [621, 622]. Colloidal silica is the main component of the final polishing compounds for these materials. They act both as a fine, uniform abrasive and as a scavenger for reaction products of polishing additives that chemically attack the silicon.

Colloidal silicas have been used to bond and improve the attrition resistance of catalyst powders used in streams of reacting gas or liquid. The silica provides sufficient strength and hardness to prevent the catalyst pellets from being broken down and swept away by the stream. Acrylonitrile is made from propylene and ammonia by such a fluidized bed reaction [623, 624]. Ammonia-stabilized colloidal silicas are generally used in these applications because of the poisoning effect of sodium.

Photographic films and papers often incorporate colloidal silicas as grain growth regulators or dye receptors.

Beverages, such as wine, beer, or fruit juices can be clarified using colloidal silica as an aid to the flocculation of the proteins which cause the materials to be hazy.

#### 48.7.4.8 Storage, Handling, and Transportation

Colloidal silicas generally undergo irreversible precipitation of the silica if frozen.

Therefore, they are generally stored in heated buildings. If outdoor bulk storage is required, tanks should be heated and insulated in climates where freezing might occur. Heated trucks are typically used in cold climates for shipping colloidal silicas.

Colloidal silica is sometimes freeze-stabilized by addition of organic substances such as glycols. The amount added is insufficient to prevent freezing, but does prevent irreversible precipitation.

Storage in plastic, fiberglass-reinforced plastic, stainless steel or lined steel tanks is usually recommended.

Typically, the main hazard associated with colloidal silicas is their alkalinity. However, since the pH of most commercially available materials is < 10.5 they may irritate the skin or eyes, but do not cause irreversible burns. In applications where a respirable mist can be formed, operators should be protected by engineering design or suitable respirators. Since colloidal silica is amorphous, it is less toxic than crystalline silica.

#### 48.7.4.9 Economic Aspects

Major manufacturers of colloidal silica and their trade names are as follows:

|                 |           |                  |
|-----------------|-----------|------------------|
| Bayer           | Baykisol  | (Germany)        |
| Du Pont         | Ludox     | (United States)  |
| Eka Nobel       | Bindzil   | (Sweden)         |
| Hispano Quimica | Hispacil  | (Spain)          |
| Monsanto        | Syton     | (United Kingdom) |
| Nalco Chemical  | Nalcoag   | (United States)  |
| Nippon Shokubai | Seahostar | (Japan)          |
| Nissan          | Snowtex   | (Japan)          |
| PQ Corporation  | Nyacol    | (United States)  |

Estimates of the colloidal silica market discussed in this section are based on [557, 558].

The U.S. market for colloidal silica is the largest in the world. The total market for North America is estimated at > 14000 t (100% silica basis) and valued at \$50 × 10<sup>6</sup> [555]. These figures include ca. 1500 t consumed in Canada. Kline estimates that the total West European market for colloidal silica was 5500 t (100% silica basis) in 1992, valued at over DM 30 × 10<sup>6</sup> [558]. In Japan colloidal silica production in 1988 was estimated at

4500 t (100% silica basis) and was expected to grow significantly [557].

The total annual capacity for the manufacture of colloidal silica in North America is estimated at 16 000–21 000 t (100% silica basis). The total capacity in Europe is estimated at 6000 t.

Nalco is the largest producer for the North American market followed by Du Pont and PQ Corporation. Eka Nobel of Sweden has a relatively small plant in the United States (ProComp Inc.). Alchem, a joint venture of C-I-L Inc. and Nalco in Ontario, is the sole Canadian producer.

In the United States, Monsanto imports colloidal silica from its plant in Wales and small amounts are also imported from Japan. Exports from the United States are believed to be relatively small at about 1800 t/a. Nalco and Du Pont are the main exporters, and Japan, Taiwan, and Canada are the principal destinations. Some colloidal silica is also exported to Europe.

The largest producers of colloidal silica in Western Europe are Bayer in Germany, Eka Nobel in Sweden, and Monsanto in the United Kingdom, followed by Akzo in the Netherlands and Hispano Quimica in Spain. There are a few smaller producers in Italy and France.

Western Europe imports some colloidal silica from the United States and exports relatively small amounts to the United States, Eastern Europe, the Far East, and the CIS.

In 1987–1988 the North American market for colloidal silica was expected to grow at an average rate of 5%/a, and the Western European market at 3.5%/a in volume. The author estimates that the actual growth for both markets has been lower due to the world economic situation.

Colloidal silica prices vary with grade, silica concentration, volume purchased, and country in which it is sold. In the United States the price is about \$1.80–1.95 per pound for electronic-grade material, and \$1.15–1.40 per pound for other grades (100% silica basis). In Western Europe the prices vary in the range 5.5–8.3 DM/kg (100% silica basis).

## 48.7.5 Silica Gel

### 48.7.5.1 Introduction

Silica gel has the nominal chemical formula  $\text{SiO}_2 \cdot x\text{H}_2\text{O}$  and is a solid, amorphous form of hydrous silicon dioxide distinguished by its microporosity and hydroxylated surface. The structure of silica gel is an interconnected random array of ultimate polymerized silicate particles, called micelles, which are spheroidal and 2–10 nm in diameter (resulting in high surface areas of ca. 300–1000  $\text{m}^2/\text{g}$   $\text{SiO}_2$ ). The properties of silica gel are a result of the silica micelles, their state of aggregation, and the chemistry of the micelle surface.

Control of the surface area, porosity, and surface chemistry of silica gel has led to numerous and diverse uses. Examples include adsorbents for water or other species, abrasives and thickeners in dentifrice, efficient matting agents in coatings, chromatographic media, and catalyst supports. The utility is reflected in an estimated world production of 90 000 t/a, excluding China, the CIS, and Eastern Europe [625].

The development of silica-gel science and technology began with the pioneering work of GRAHAM reported in 1861 [626], although observations of gelation had been reported earlier [627, 628]. Commercial production began at the Silica Gel Corporation (now part of W. R. Grace & Co.-Conn.) with the process invented by PATRICK in 1919 [629]. Commercial development and applications expanded worldwide [627], and the colloid chemistry of silica was explored further [630]. With the application of NMR spectroscopy, small-angle X-ray scattering, and fractal geometry [631], further fundamentals of silica gel chemistry are being elucidated.

### 48.7.5.2 Structure, Properties, and Characterization

**Structure.** Silica gel is prepared by the neutralization of aqueous alkali metal silicate with acid [627, 629, 630]; for example:

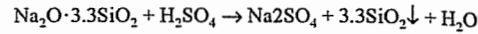

A complete synthesis of silica gel by this typical commercial route is outlined in Figure 48.53. Alternatively, stable silica sols may also be gelled [630]. Another method involves the hydrolysis of silicon alkoxides with water, catalyzed by acid or base [631].

The neutralization of sodium silicate initiates a polymerization of silicate tetrahedra in a random, amorphous manner to form small spheroids called micelles. The solution containing the micelles while still liquid is known as a hydrosol.

Gel formation occurs when the interaction of separate micelles through hydrogen bonding and eventual interparticle condensation becomes significant. The rate of gelation depends on many variables such as  $\text{SiO}_2$  concentration, pH, temperature, and mixing; this is discussed in detail in [630, 631]. Polymerization and cross-linking continue after the hydrosol has solidified into a hydrogel. The random, amorphous structure is reflected in a lower skeletal density for silica gel of 2.1–2.2  $\text{g}/\text{cm}^3$  compared to quartz (2.65  $\text{g}/\text{cm}^3$ ) and the lack of X-ray crystallinity. The micelle, which is the ultimate particle, consists of  $\text{SiO}_2$  in its interior and Si–OH on its surface. Solid-state  $^{29}\text{Si}$  NMR indicates tetrahedral geometry about the silicon atoms and confirms the presence of bulk  $\text{SiO}_2$  and surface Si–OH [632]. The micelle's size determines the specific surface area of the silica gel; a typical micelle size of ca. 2.5 nm in diameter corresponds to ca. 1000  $\text{m}^2/\text{g}$ .

Once the gel network forms, several processing steps are performed to give the finished gel [633]. First, washing is normally performed to remove dissolved salts. Because silica gel has a very low ion-exchange capacity for cations or anions at moderate pH, salt removal is a diffusion-controlled dilution process. Next, if desired, the interaction between micelles and micelle growth can be accelerated by aging in aqueous media under conditions where silica is slightly soluble. A process in which silica dissolves from regions of positive curvature and redeposits at regions of

negative curvature reinforces the hydrogel network. Thus, a continuous gel structure is formed.

During the drying process, the surface tension of the solvent in the pores can act to shrink the hydrogel volume. In slow drying, as water is evaporated from a silica hydrogel, the structure collapses gradually due to the surface tension of water. Eventually a point is reached where even though water is still evaporating the gel structure no longer shrinks. At this point the gel is called a xerogel. Fast drying can minimize the shrinkage, and removal of water by solvent exchange followed by drying has the same effect. Materials that are dried with negligible loss of pore volume are known as aerogels.

Drying of silica gels can also be carried out under conditions where the solvent in the pores is above its critical point and is vented while maintaining temperature and pressure. KISTLER [634] dried gels supercritically after replacing the water of the hydrogel with alcohol. Alternatively the liquid in the pores can be exchanged for liquid  $\text{CO}_2$ , which has more convenient critical-point properties [635, 636]. Considerable interest has been focused on such techniques recently due to the high porosity and mechanical properties achievable [631, 635, 637].

The resulting products from a scheme as in Figure 48.53 are high purity silica gels with controlled porosity. Transmission electron micrographs show the pore structure of silica gel. Typical properties are as follows:

| Chemical analysis (dry basis) (%) |  |
|-----------------------------------|--|
| $\text{SiO}_2$                    | 99.71  |
| $\text{Al}_2\text{O}_3$           | 0.10   |
| $\text{TiO}_2$                    | 0.09   |
| $\text{Fe}_2\text{O}_3$           | 0.03   |
| Trace oxides                      | 0.07   |
| Physical analysis                 |  |
| Total volatiles                   | 5–6.5%   |
| Surface area                      | 750–800 $\text{m}^2/\text{g}$                          |
| Pore volume                       | 0.43 $\text{cm}^3/\text{g}$                            |
| Average pore diameter             | 2.2 nm   |
| Apparent bulk density             | 0.72 $\text{g}/\text{cm}^3$                            |
| Skeletal density                  | 2.19 $\text{g}/\text{cm}^3$                            |
| Specific heat                     | 920 $\text{J}/\text{kg}^{-1}\text{K}^{-1}$             |
| Thermal conductivity              | 522 $\text{J}/\text{m}^{-1}\text{h}^{-1}\text{K}^{-1}$ |

**Surface Chemistry and Stability.** The physical microporosity of silica gel is an important property, as is the chemistry of its bulk and surface species (Figure 48.54). Pure silica gel has a hydroxylated surface covered with silanol groups. These hydroxyl groups are neither very acidic nor basic, with  $\text{p}K_a \approx 6$  and an isoelectric point at ca. pH 2. The hydroxylated surface is hydrophilic and adsorbs moisture readily. This adsorbed moisture can be desorbed thermally at 100–200 °C leaving behind  $\approx 5.5$   $\text{OH}/\text{nm}^2$  (or ca. 5% silanol groups on a 300  $\text{m}^2/\text{g}$  silica). These silanols are more difficult to remove but this can be done thermally by condensation to form siloxanes and water. Temperatures near 600–800 °C are required to dehydroxylate to ca. 1  $\text{OH}/\text{nm}^2$ . At this silanol concentration the surface is hydrophobic.

**Characterization.** Numerous methods have been developed to characterize the porosity, structure, and chemistry of silica gels [630] and new methods continue to be applied [631].

With regard to porosity, differently prepared silica gels can be described on the basis of pore diameter  $d$  as microporous ( $d < 2$  nm), mesoporous ( $d \approx 2$ –50 nm), or macroporous ( $d > 50$  nm) [638]. The most generally useful methods for characterizing these structures with respect to surface area, pore volume, and pore-size distribution are nitrogen adsorption/desorption techniques. The primary method for surface area is the BET procedure [639] (ASTM D3663-84 or DIN 66131). Methods have been proposed to improve on the BET technique in small pores, such as the  $t$ -plot method [640], and the  $\alpha_s$  method [641]. The related  $\text{N}_2$  pore volume and pore-size distribution (pore volume as a function of pore diameter) methods are ASTM procedures D4222-83 and D4642-87, respectively. The porosity of a silica gel, determined by  $\text{N}_2$  porosimetry, is shown in Figure 48.55. Alternative porosity measurement techniques include mercury porosimetry, water pore volume, and oil absorption.

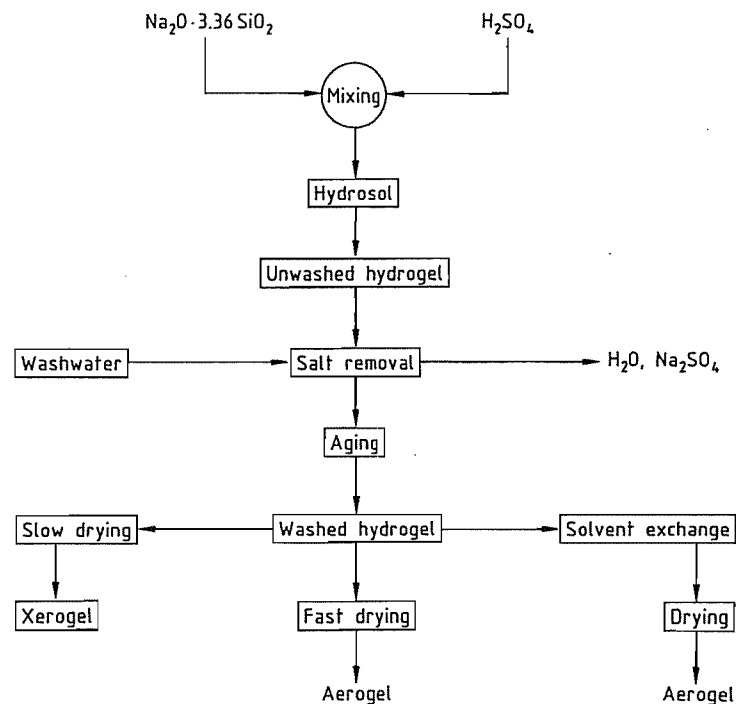

Figure 48.53: Schematic of silica gel manufacture.

Elemental analysis of silica gel focuses on trace elements in the range of < 1%. Inductively coupled plasma atomic emission spectroscopy (TCP-ES) is becoming the preferred technique. pH measurement is performed on slurries and reflects the balance of residual trace elements (ASTM D1208, DIN ISO 787 1X, JIS K 5101/24).

The moisture content of silica gel is important to provide an anhydrous basis for chemical analysis and because the hydration of the surface and pores (Figure 48.54) is important to performance in applications. Most standards require two measurements: moisture loss on drying for 2 h at 105 °C (ASTM D280, DIN ISO 787/11, or JIS K 5101/21) and loss on ignition after this drying by heating for 2 h at 1000 °C (ASTM D 1208, DIN 55921, or JIS 5101/23). Another method often used in the United States prior to analysis to provide a solids basis is to measure total volatiles as a

weight per cent loss on heating for 1 h at 954 °C.

The surface hydroxyl groups of silica gel can be characterized by thermogravimetric analysis [630], vibrational spectroscopy [631, 642], and nuclear magnetic resonance [631, 632, 643]. The information obtained concerns hydroxyl concentration, hydrogen bond interaction between hydroxyl groups, and distribution of  $\equiv\text{Si}-\text{OH}$  and  $=\text{Si}-(\text{OH})_2$  species on the surface. The adsorptive properties of variously hydroxylated silica materials are an indirect means of characterizing the surface.

Particle-size measurement is also important in silica-gel characterization (DIN 53206). The method for granular gel is standardized sieve screening (ASTM D4513). For particles less than ca. 0.1 mm in size, laser light scattering (ASTM D4464) and conductivity methods are preferred. For particles less than 100 nm, light scattering, electron microscopy, and small angle X-ray scattering are used.

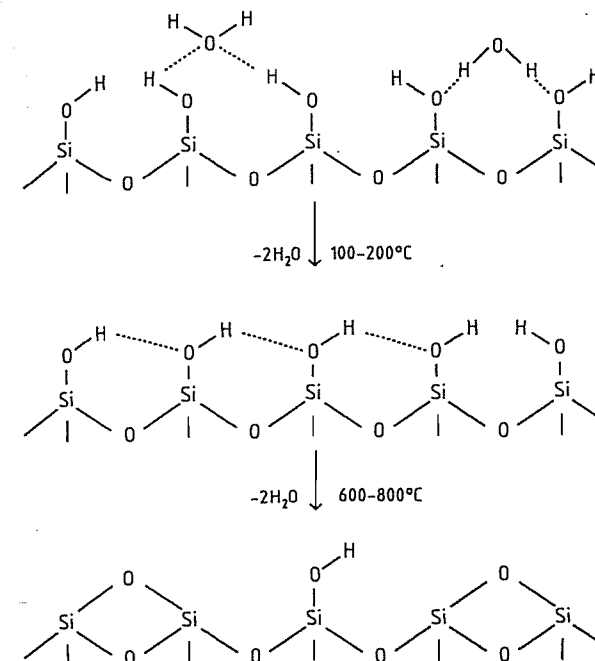

Figure 48.54: Schematic representation of the dehydration of a silica gel surface.

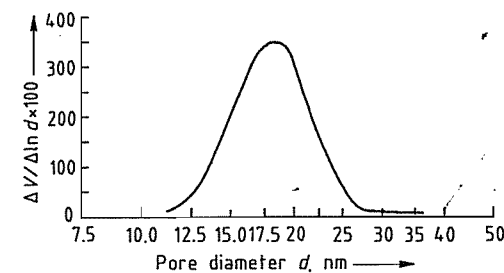

Figure 48.55: Nitrogen pore-size distribution of a silica gel similar to the fast dried sample of Table 48.23 ( $V =$  pore volume).

first at 75–120 °C then 300–400 °C. A typical small pore gel made by this process is described in Table 48.23.

The Patrick gelation conditions, with relatively minor variation, have been the basis of most silica gel manufacture since. The next major change in silica gel products was the development of gels of higher pore volume and pore diameter by washing and aging hydrogels under basic conditions. Early references [644, 645] refer to this technology but large scale commercial introduction occurred around 1945. Base washing was a common industrial practice before 1950. In one example [646] a 17%  $\text{SiO}_2$  hydrosol gelled in about one hour. The hydrogel was broken up and washed with an aqueous ammonia solution of pH 9 for ca. 45 h then tray dried. Similar conditions are described for intermediate-density gel [633]. One further variation involves fast drying [647] which increases the pore volume and diameter of such gels. Typical properties of acid-washed regular density, ammonia-washed intermediate density, and a flash-dried product are shown in Table 48.23.

#### 48.7.5.3 Production

**Processes.** The original production process of PATRICK [629] as practiced by the Silica Gel Corporation starting in 1919 contains the main elements of modern processes using aqueous silicate raw materials. The initial step is the batch neutralization of sodium silicate (1.185 g  $\text{SiO}_2/\text{cm}^3$ ) at 35–80 °C with 10% HCl to form a hydrosol. A hydrogel then forms after 3–5 h at ambient temperature and is sized, washed with water to remove salts, and dried

Table 48.23: Typical properties of various silica gels.

| Property                                    | Regular density |                   | Intermediate density |
|---|-----------------|-------------------|----------------------|
|   | Slow dried      | Slow dried        | Fast dried           |
| Total volatiles <sup>a</sup>                | 5               | 6                 | 6                    |
| Na <sub>2</sub> O dry basis, %              | < 0.1           | < 0.1             | < 0.1                |
| SiO <sub>2</sub> dry basis, %               | < 0.1           | < 0.1             | < 0.1                |
| Al <sub>2</sub> O <sub>3</sub> dry basis, % | 0.05            | 0.05              | 0.05                 |
| pH <sup>b</sup>                             | 4.0             | 7.5               | 4.0                  |
| Specific surface area, m <sup>2</sup> /g    | 750             | 325               | 390                  |
| Pore volume, cm <sup>3</sup> /g             | 0.40            | 1.1               | 1.8                  |
| Average pore diameter, nm                   | 2.1             | 13.5              | 18.5                 |
| Water adsorption, %                         |                 |                   |                      |
| 10% R.H.                                    | 7.5             | 2.0               |                      |
| 80% R.H.                                    | 35              | 17.0 <sup>c</sup> |                      |

<sup>a</sup> Weight loss after heating in air at 954 °C.

<sup>b</sup> pH of an aqueous slurry of the gel at 5% solids.

<sup>c</sup> > 90% water adsorption at 100% R.H.

Several methods of forming hydrogel, typically into spherical shapes, have been developed. Some methods employ a rapid gelation after mixing in a nozzle followed by spray setting [648–651], while others form beads in an oil phase immiscible with the hydrosol [652]. In some bead processes, recycled, dried, and powdered gel is mixed with the fresh sol to improve the physical integrity of the dried gels toward disintegration after contact with liquid water [653].

The supercritical preparation of aerogels has undergone a renaissance since earlier commercial production [654] because of renewed interest in the insulation and light-transmittance properties of these materials. The shift in applications toward large panels has created the need for what are described as aerogel monoliths [631]. One such process [635] forms a silica alcogel then exchanges the alcohol for liquid CO<sub>2</sub> before supercritical drying. The resulting monoliths show good light-transmittance properties. The monoliths, typically 500 × 500 × 2.5 cm, are used to fill the space in the middle of double-pane windows.

**Environmental Protection.** In the sodium silicate/H<sub>2</sub>SO<sub>4</sub> processes the main environmental concerns are the fate of by-product process chemicals, normally aqueous Na<sub>2</sub>SO<sub>4</sub> and small amounts of aqueous NH<sub>3</sub>, and pH control of this stream.

**Quality Specifications.** Typical quality criteria for silica gel are chemical purity, moisture content, and porosity. These properties depend on manufacturing conditions such as concentrations, gelling and washing times, pH, and drying conditions. Typical properties of silica gels are reported in Table 48.23. Application-specific properties are often measured for certain end uses (see Section 48.7.5.4).

Silica gel has been described by numerous organizations for the purpose of defining the quality necessary for use in food, cosmetic, and pharmaceutical applications. In the United States, monographs for silica gel are included in the Food Chemicals Codex (1981) and The United States Pharmacopeia The National Formulary (1990). In Japan it is described in the Japanese Pharmacopeia, Standard for Cosmetic Materials, and JIS Z 0701. It is also on the “Positive” list for use in food-grade polyolefins. The EC is compiling permitted silica gel uses into a complete listing for member states. Until that listing is complete member states will maintain individual regulations.

#### 48.7.5.4 Uses

Silica gel is used extensively in a wide variety of applications; here, some major uses are described.

**Desiccants.** The earliest well identified use for silica was as an adsorbent for water. The affinity of silica gel for water is affected by its

state of activation (or moisture loading) and the degree of saturation of the surrounding fluid by water vapor. A plot of the affinity of silica gel for water vapor as a function of equilibrium relative humidity at ambient temperature is shown in Figure 48.56. The properties of two silica desiccants have been described in Table 48.23.

Silica gel is widely used in the narrow pore form to keep enclosed spaces dry, such as in cable junctions, pharmaceutical containers, and consumer goods. Silica gel is also used for drying natural gas. The wider pore form of silica is used to prevent local condensation in high-moisture environments and to absorb condensed mists of moisture. Another application is to use silica gel to maintain a constant humidity environment around art objects [655].

Desiccants have been described in several countries by standards Mil-D-3716B (United States), DEF STAN 80-22 (United Kingdom), and JIS Z 0701-77. These descriptions include standard properties and methods of analysis.

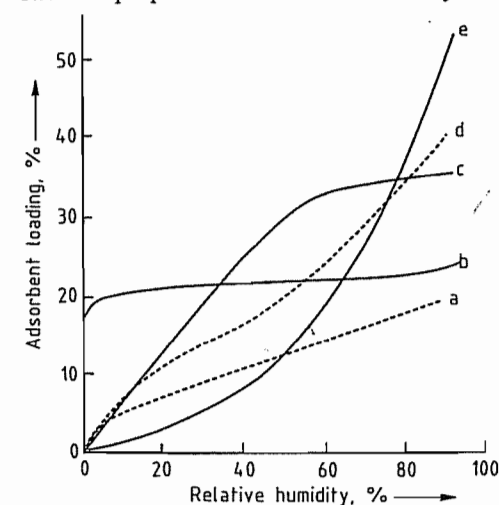

Figure 48.56: Water adsorption isotherms at room temperature as a function of relative humidity for several materials: a) Granular Al<sub>2</sub>O<sub>3</sub>; b) Zeolite A (Na<sup>+</sup> form); c) Regular density silica gel; d) Spherical Al<sub>2</sub>O<sub>3</sub>; e) Intermediate density silica gel.

**Adsorbents.** Silica gel can adsorb many species other than water, particularly polar substances [656]. In addition to chemical

processing, silicas have many uses in food processing. Treatment of beer with hydrogels, hydrous gels, or xerogels to remove haze-forming proteins is one example [645, 657]. Another food use is the adsorptive purification of glyceride oils [658]. Silica gels also are used extensively in chromatography [659].

**Dentifrice.** Silica gels have long been components of dentifrice formulations [660] but more recently were employed more for their suitable abrasiveness for cleaning than simply as carriers or thickeners. Xerogels [661] and hydrous gels [662] are used, but must compete with precipitated silicas [663] in this application. The abrasiveness of a dentifrice can be measured [664] and generally correlates with how effectively it cleans the teeth.

**Coatings.** Fine sized silicas (2–15 μm) are used extensively to control the reflectance of coatings [646, 647, 654]. By interrupting the surface of the coating the gloss of the surface (as measured by ASTM D 523) is reduced but particles too large can harm the appearance of the surface. The fineness of grind (ASTM D1210-79) can be measured and specified. In clear coatings, the refractive index of the silica is important to maintain clarity. A typical matting agent has a particle size of ca. 10 μm, a pore volume of ca. 1.8 cm<sup>3</sup>/g, and a fineness of grind on the Hegman scale of > 4 (ASTM test).

**Catalysts and Catalyst Carriers.** The high surface area of silica gel makes it an attractive solid on which to effect catalysis. Silica itself does not catalyze many reactions of commercial significance. Silica aluminas have acidic catalytic properties best exemplified in catalytic cracking [627, 665]. Silica gel is also used as a support in olefin polymerization [666–668].

**Suppliers.** Silica gel suppliers (with trade names following in parentheses) are summarized: Akzo, Asahi, BASF (Silica-Perlen, Silica-Pulver), Crosfield Chemicals, Unilever Specialty Chemicals Group (Gasil, Lucilite), Eagle, Fuji Silysia (Sylopute, Art Sorb), Glidden, (Silcron), W. R. Grace & Co.-Conn. (Sy-

loid, Sylobloc, TriSyl), Kali Chemie (KC-Trockenperlen), PQ (Britesorb), and Uetikon (Diamantgel).

#### 48.7.5.5 Economic Aspects

Silica gel is but one form of synthetic amorphous silica. Published estimates of world production (excluding the Eastern bloc countries and China) of all amorphous silicas (t/a) include:

|      |                 |
|------|-----------------|
| 1974 | 475 000 [669]   |
| 1988 | 650 000 [670]   |
| 1990 | 1 000 000 [625] |

Only the 1990 estimate specifically identified the silica gel tonnage at 90 000 t/a. Between 30–50% of silica gel is estimated to be used in desiccant applications.

#### 48.7.5.6 Legal Aspects

**Toxicology and Occupational Health.** Silica gel is listed under TSCA in the United States, the Domestic Substances List (DSL) in Canada, the European Inventory of Existing Commercial Substances (EIECS), the Australian Inventory of Chemical Substances, and the Japanese Core Inventory (MITI).

Silica gel is generally classified as synthetic amorphous silica. Epidemiological studies have indicated low potential for adverse health effects in humans [671]. Silica gel is not listed on IARC, National Toxicology Program (NTP), or OSHA carcinogen lists.

Animal tests conducted in 1976–1978 (18-month exposure at 15 mg/m<sup>3</sup>) showed silica deposition in respiratory macrophages and lymph nodes, minimum lung function impairment, and no silicosis [671]. OSHA has established a PEL of 6 mg/m<sup>3</sup> and ACGIH has established a TLV of 10 mg/m<sup>3</sup>.

Tests conducted for the U.S. DOT classification gave the following results for finely ground silica gel:

|                                       |                            |
|---------------------------------------|----------------------------|
| 1-h LC <sub>50</sub> (rat)            | > 2 mg/L                   |
| 48-h oral LD <sub>50</sub> (rat)      | > 31 600 mg/kg (estimated) |
| 48-h dermal LD <sub>50</sub> (rabbit) | > 2000 mg/kg (estimated)   |
| Not considered an ocular irritant.    |                            |

Tests conducted for United States FDA approval for use in foods (see 21 CFR 160.105, 160.815, and 172.480) showed:

LD<sub>50</sub> (mouse) 8000 mg/kg (limit of test)  
LD<sub>50</sub> (rat) 4500 mg/kg (limit of test)  
6-month feeding tests (rat) at levels up to 10% of diet produced no effects.

A long-term bioassay of chronic toxicity on mice and rats concluded that “proper dietary administration of micronized silica has proven to be generally safe with no long-term toxic effects” [672].

**Storage and Transportation.** Silica gel should be stored in sealed containers to protect product quality, particularly to avoid moisture adsorption or desorption. Silica gel is not considered a hazardous material by the International Air Transportation Association (IATA Resolution 618, Attachment “A”, 1992), the U.S. DOT (49 CFR), or in EEC Council Directive 67/548/EEC.

#### 48.7.6 Pyrogenic Silica

The term pyrogenic silica refers to highly dispersed silicas formed from the gas phase at high temperature. Nowadays, the most important production process is flame hydrolysis. The electric-arc process is of little and the plasma process of no economic significance. The designation pyrogenic used in this chapter therefore always refers to silica produced by flame hydrolysis.

##### 48.7.6.1 Flame Hydrolysis

The flame hydrolysis process was developed in the late 1930s and patented in 1942 [673]. The original aim was to develop a “white carbon” as a reinforcing filler for rubber. However, for technical and economic reasons precipitated silicas were adopted for this use.

In the meantime pyrogenic silica has found applications in numerous branches of industry.

Capacities for pyrogenic silicas amounted to ca. 100 000 t worldwide in 1991. Producers are Degussa (Aerosil), Cabot (Cab-o-sil), Wacker (HDK), and Tokuyama Soda (Reol-sil).

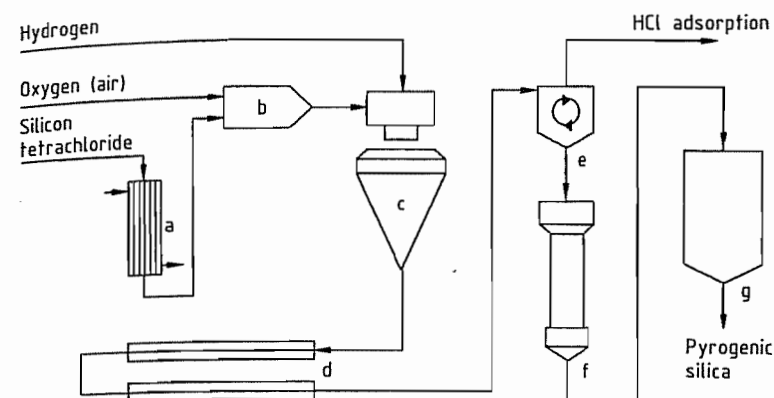
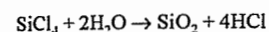
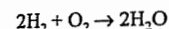

Figure 48.57: General process scheme of flame hydrolysis: a) Vaporizer; b) Mixing chamber; c) Burner; d) Cooling section; e) Separation; f) Deacidification; g) Hopper.

#### Production Process

Silicon tetrachloride is the usual raw material for flame hydrolysis. It is continually vaporized, mixed with dry air and then with hydrogen, fed to a burner, and hydrolyzed:



The gases leaving the reaction chamber contain all of the silica in the form of an aerosol.

The silica is separated almost quantitatively from the hydrochloric acid-containing off-gas by cyclones (centrifugal separators) or filters. Treatment with steam and air in a fluidized-bed reactor is then carried out to remove residual hydrochloric acid adsorbed on the large surface of the silica. The hydrogen chloride is washed from the off-gases in adsorption columns to give hydrochloric acid in commercial concentrations. The hydrochloric acid formed can be reused by reacting it with silicon to produce silicon tetrachloride and hydrogen.

The properties of pyrogenic silica can be controlled by varying reaction parameters such as flame composition and flame temperature. Thus, desired specific surface areas in the range 50 to 400 m<sup>2</sup>/g can be produced selectively.

The product, with a bulk density < 20 g/L, is pneumatically transported to packing machines, where the tapped density is increased

to 50–120 g/L by compacting rollers or vacuum packers.

A schematic of the flame hydrolysis process is shown in Figure 48.57.

It is also possible to use methyltrichlorosilane alone or mixed with silicon tetrachloride as raw material. In this case, however, simultaneous hydrolysis and oxidation is required, which requires modification of the production process.

#### Morphology

Flame hydrolysis produces extremely fine, mostly spherical particles with diameters of ca. 10 nm. The size of the average primary particles, which can be measured by transmission electron microscopy (TEM), ranges from 7 to 40 nm. The particle-size distribution becomes narrower with decreasing primary particle size (Figure 48.58).

The small particles give rise to high specific surface areas of ca. 50–400 m<sup>2</sup>/g. This consists almost entirely of outer surface, which is not formed by pores, and is readily accessible to diffusion processes. The specific surface areas determined by adsorption (e.g., by the BET method [674]) are in agreement with those determined by TEM within certain limits. Figure 48.59 shows the BET surface area as a function of the mean particle size measured by TEM.

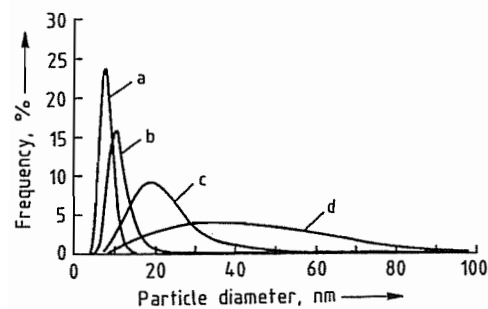

Figure 48.58: Primary particle-size distribution of pyrogenic silicas with various specific surface areas: a) 300; b) 200; c) 90; d) 50 m<sup>2</sup>/g.

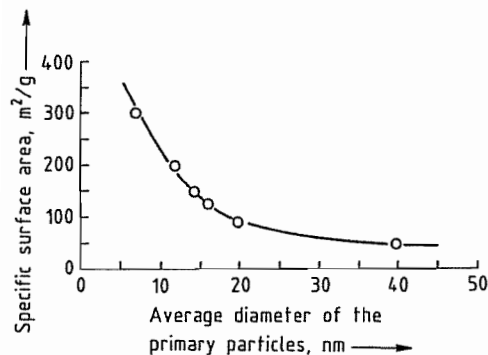

Figure 48.59: Correlation of the average primary particle size with the specific surface area of different pyrogenic silicas.

The primary particles do not occur in isolation, but form aggregates by intergrowth, and agglomerates through cohesion forces. In contrast to precipitated silicas, pyrogenic silicas cannot be produced in the form of defined aggregates or agglomerates. The primary particles can be identified by TEM, but it is not possible to distinguish aggregates from agglomerates [675].

The size of the agglomerates actually present in a liquid or powder mixture depends mainly on the dispersion and mixing intensity during preparation.

Figure 48.60 shows a TEM photograph of a pyrogenic silica with an average primary particle size of ca. 40 nm and a specific surface area of ca. 50 m<sup>2</sup>/g, while Figure 48.61 shows one with an average primary particle size of ca. 7 nm and a specific surface area of ca. 300 m<sup>2</sup>/g.

## Solid-State Properties

Pyrogenic silicas are X-ray amorphous. For example, X-ray diffraction photographs with a detection limit of 0.2% for Aerosil 200, a hydrophilic pyrogenic silica with a specific surface area of ca. 200 m<sup>2</sup>/g, show no crystallinity [676]. This fact is of considerable significance for industrial hygiene, since current experiences indicate that the development of silicosis on inhalation of silica dust is associated with the crystallinity.

The refractive index of 1.45 is similar to that of silica glass. The particle size and the surface chemistry have a small but measurable influence on the refractive index. Transparent mixtures can be prepared from pyrogenic silicas and most organic polymers.

Pure pyrogenic silicas are thermally quite stable. Thus, heating for 7 d at 1000 °C results in no change of the morphology and no crystallization. The thermal stability is, however, significantly lower if other substances are present. Traces of alkali or alkaline-earth metal ions in particular act as mineralizers [677].

Since pyrogenic silicas are produced from readily vaporizable starting materials that can be easily purified by distillation, impurity concentrations resulting from the raw materials are very low. Generally, the silicon dioxide content is > 99.8% after ignition for 2 h at 1000 °C to remove chemically and physically adsorbed water. The content of hydrochloric acid by-product can be reduced to less than 250 ppm by suitable measures, which is adequate for most applications.

The purity of pyrogenic silicas is specified particularly for their use in pharmacy. The most important monographs concerning this are:

- European Pharmacopeia 2 (Silica Colloidal Anhydrica)
- DAB 10 (Hochdisperses Siliciumdioxid)
- U.S.P./National Formulary XVII (Colloidal Silicon Dioxide)

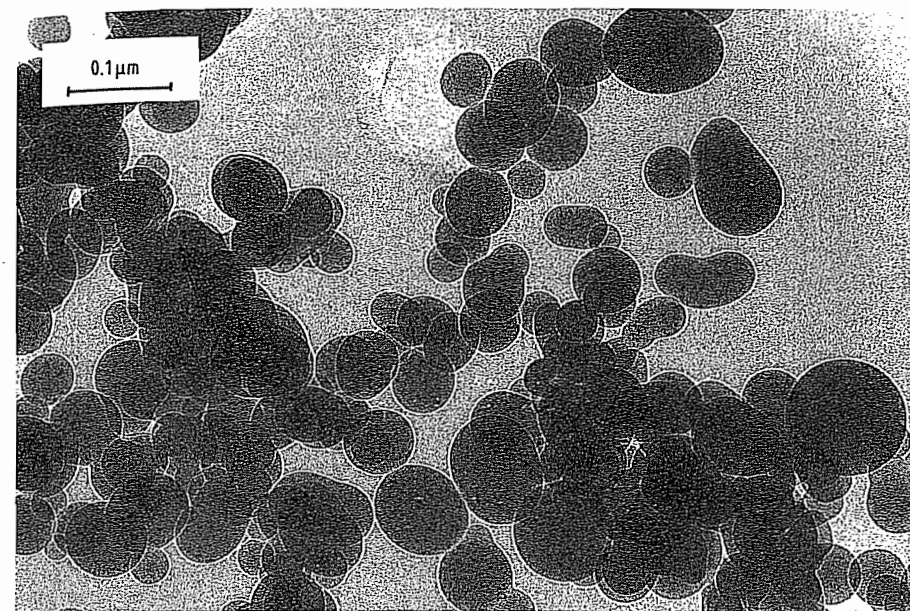

Figure 48.60: TEM photograph of a pyrogenic silica with an average primary particle size of ca. 40 nm and a specific surface area of ca. 50 m<sup>2</sup>/g.

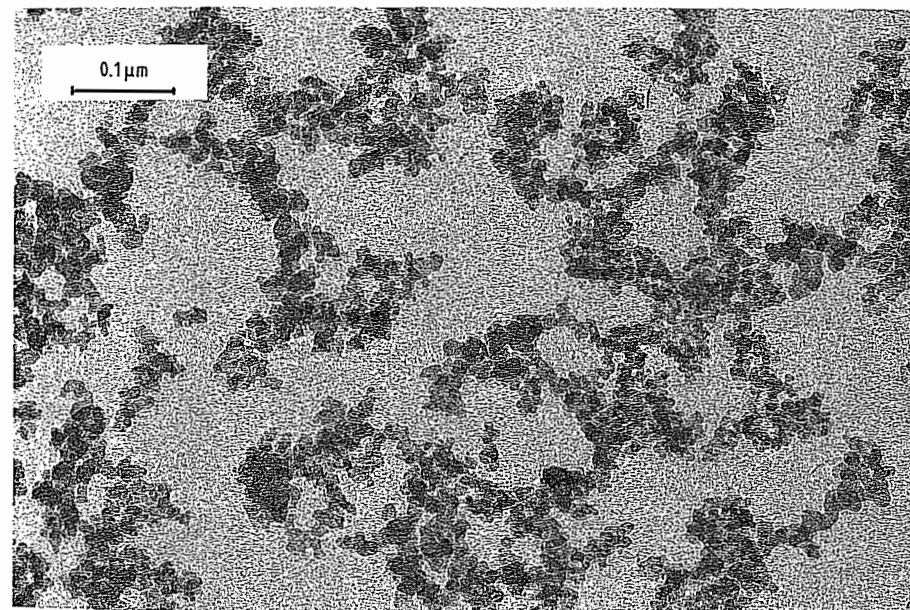

Figure 48.61: TEM photograph of a pyrogenic silica with an average primary particle size of ca. 7 nm and a specific surface area of ca. 300 m<sup>2</sup>/g.



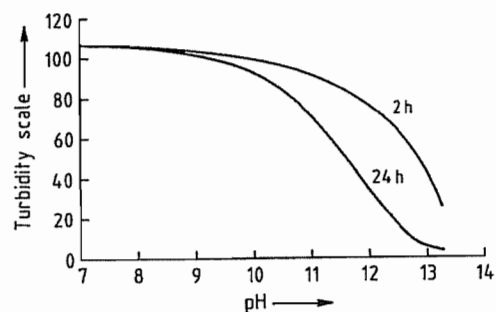

Figure 48.62: Time dependence of the solubility of a pyrogenic silica in caustic soda.

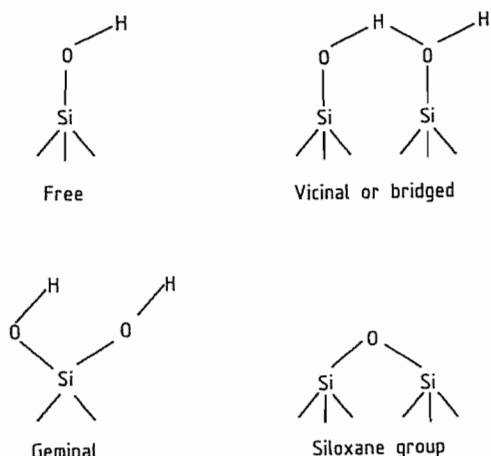

Figure 48.63: Siloxane and silanol groups on the silica surface.

Pyrogenic silicas are largely inert chemically. They dissolve in strong alkali solutions with silicate formation and in hydrofluoric acid with the formation of silicon tetrafluoride. The solubility in pure water is similar to that of quartz (ca. 150 mg/L). Figure 48.62 shows the solubility behavior of a pyrogenic silica with a specific surface area of 200 m<sup>2</sup>/g in the alkaline pH range.

### Surface Chemistry

Siloxane and silanol groups occur on the surface of the silica particles. The former are hydrophobic while the latter are hydrophilic and make the pyrogenic silica wettable. The silanol groups can occur isolated, bridged, or geminal (Figure 48.63).

The silanol groups can be determined quantitatively by reaction with lithium aluminum hydride and measurement of the amount of hydrogen formed. The densities lie between 2.5 and 3.5 SiOH/nm<sup>2</sup> [678, 679]. The silanol groups are weakly acidic, which causes a zeta potential for the pyrogenic silicas of zero at a pH value of approximately two [680]. Pyrogenic silicas become preferably negatively charged by friction [681].

IR spectroscopy is important for the analysis of the surface chemistry of pyrogenic silicas [679, 682–685], although recent methods such as solid-state NMR spectroscopy promise further results. The following IR bands are of significance:

|                           |                            |
|---------------------------|----------------------------|
| –O–D                      | 2760 cm <sup>-1</sup>      |
| –C–H                      | 2900–3000 cm <sup>-1</sup> |
| –SiOH isolated            | 3750 cm <sup>-1</sup>      |
| –SiOH bridged             | 3000–3800 cm <sup>-1</sup> |
| –SiOH combination band    | 4550 cm <sup>-1</sup>      |
| H <sub>2</sub> O adsorbed | 5200 cm <sup>-1</sup>      |

Immediately after production pyrogenic silicas show mainly isolated silanol groups. In the course of time, adsorbed water reacts with strained siloxane groups and forms bridged silanol groups. This aging can easily be followed by IR spectroscopy (Figure 48.64) [679].

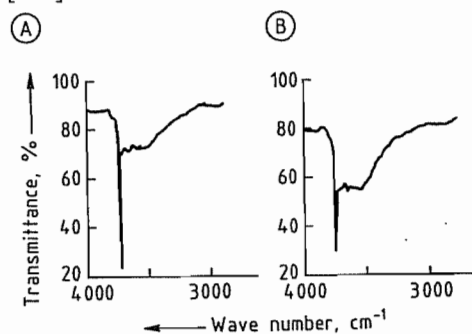

Figure 48.64: IR spectra of pyrogenic silica (200 m<sup>2</sup>/g specific surface area) shortly after production (A) and after storage for one year (B).

The desorption energies of both the chemically and physically bound water can be determined by gravimetric adsorption and temperature-programmed desorption [686]. Thus, the following energies were determined: 50 kJ/mol, for water hydrogen bonded to a silanol group, and 84 kJ/mol for water bonded to

two neighboring silanol groups. The elimination of water from neighboring silanol groups and isolated silanol groups requires 122 kJ/mol and 130 kJ/mol, respectively.

The silanol groups undergo acid-specific reactions; examples include:

- With hydride ions (e.g., LiAlH<sub>4</sub>) [678]  
=Si–OH + H<sup>-</sup> → =Si–O<sup>-</sup> + H<sub>2</sub>
- Deuterium exchange [679]  
=Si–OH + D<sub>2</sub>O → =Si–OD + HDO
- Neutralization [687]  
=Si–OH + NaOH → =Si–ONa + H<sub>2</sub>O
- Chlorination [688]  
=Si–OH + SOCl<sub>2</sub> → =Si–Cl + SO<sub>2</sub> + HCl
- Esterification with diazomethane [688]  
=Si–OH + CH<sub>2</sub>N<sub>2</sub> → =Si–O–CH<sub>3</sub> + N<sub>2</sub>

Summaries of the surface chemistry of finely divided silicas are given in [689, 690].

### Surface Modification with Silicon Compounds

Pyrogenic silicas are hydrophilic; however, a hydrophobic character is more favorable for some applications. This requirement can be met by reaction with dimethyldichlorosilane [691, 692]. The resulting silica thus is no longer wettable by water and was introduced on the market in 1962 under the name Aerosil R 972. Apart from chloroalkylsilanes, mainly hexamethyldisilazane, alkoxyalkylsilanes, and polydimethylsiloxanes are used.

Apart from methyl and longer chain alkyl groups, organofunctional groups can also be anchored on the surface of pyrogenic silicas by using silanes. This form of modification was first used on a large scale for applications in dental materials. A pyrogenic silica with a low specific surface area is treated with  $\gamma$ -methylacryloxypropyltrimethoxysilane to give an active filler that can be chemically bonded to the polymethylmethacrylate matrix and provides the dental material with very good mechanical properties [693–695].

Another use of pyrogenic silicas modified with organofunctional silanes is in toners. Un-

til recently photocopiers generally fixed the latent electrostatic image on a positively charged selenium layer. An electrostatically negatively chargeable toner is required for development, which contains a hydrophobic pyrogenic silica to improve the flow behavior and chargeability. In more modern copier systems the latent image is formed on an organic semiconductor layer, which is negatively charged and requires a positively chargeable toner. However, pyrogenic silicas tend to become negatively charged due to the presence of silanol groups even in hydrophobized products. Hence, a surface modification is necessary to allow positive charging. This can be achieved by using aminofunctional silanes, which undergo hydrolysis-stable anchoring to the silica surface [696–698].

### Characterization

Pyrogenic silicas can be characterized well on the basis of chemical and physicochemical data; however, these do not allow a definite assessment of their suitability for a particular use, which requires application testing. The following test methods have proved useful to test the suitability for many uses and also for the quality control of hydrophilic, pyrogenic silicas:

- BET surface area, m<sup>2</sup>/g (DIN 66131)
- Drying loss, % (2 h at 105 °C; DIN ISO 787/II)
- pH value (4% aqueous suspension; DIN ISO 787/IX)
- Silicon dioxide content, % (fuming with hydrofluoric acid, relative to the substance heated at 1000 °C for 2 h)

For hydrophobic or surface-modified pyrogenic silicas it is advisable to determine the carbon content instead of the silicon content, since the former provides information on the extent of surface loading.

### Uses

**Reinforcing Fillers.** Pyrogenic silica is used in large quantities as an active filler in silicone

rubber. In RTV silicone sealants, both hydrophilic and hydrophobic pyrogenic silica are used (ca. 10%) to modify mechanical properties such as Shore hardness, tensile strength, and tear strength. High temperature vulcanizing (HTV) silicone rubber requires ca. 30% pyrogenic silica to improve the mechanical properties. Hydrophobic pyrogenic silicas with strongly reduced thickening action are used in liquid silicone rubbers. Theories of the reinforcing action of pyrogenic silica in silicone rubber are discussed in [699–701].

Pyrogenic silicas are also used as active fillers in natural and synthetic rubber, particularly if extremely high mechanical properties are required, as in cable sheathing, seals, or conveyor belts.

In fluoroelastomers, both hydrophilic and hydrophobic silicas improve the mechanical properties [702, 703], even under the action of aggressive gases.

**Thickening and Thixotropization.** An important application for pyrogenic silicas is the adjustment of the rheological properties of liquid systems such as paints, thermosetting resins, and printing inks. The increase in viscosity generally plays a minor role; thixotropization and the development of a yield value are decisive in practice. These effects are generally attributed to the formation of a three-dimensional network of silica agglomerates, which fixes the liquid in “cells” and thus increases the viscosity. The silica particles interact via silanol groups. The spatial network is destroyed by mechanical stress (e.g., stirring or shaking) to an extent which depends on the intensity and duration of energy input, whereby the viscosity decreases. The silica network regenerates when the stress is removed, and the original viscosity returns. This theory has proved suitable for simple, nonpolar liquids, but is not applicable to complex and/or polar systems, in which adsorption and solvation effects determine the rheological activity [704], especially in the case of hydrophobic pyrogenic silicas.

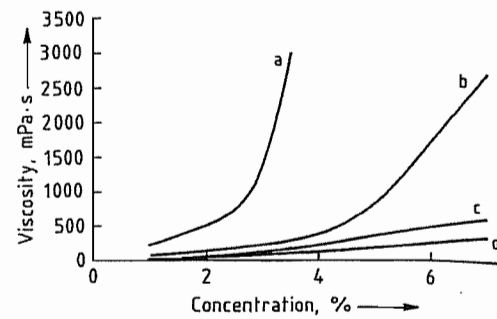

Figure 48.65: Thickening effect of a pyrogenic silica with  $200 \text{ m}^2/\text{g}$  specific surface area (Aerosil 200) in various solvents: a) Xylene; b) Butylacetate; c) Diacetone alcohol; d) Butanol.

Hydrophilic pyrogenic silicas show the best thickening action in nonpolar liquids (Figure 48.65).

**Antisettling Agents.** Closely linked with the control of the rheological properties of liquid systems is the action of pyrogenic silicas as antisettling agents. The establishment of a flow limit hinders settling of suspended particles, depending on their density, size, and shape. If settling does occur, pyrogenic silica generally prevents caking of the sediment and ensures easy dispersibility.

This effect is mainly utilized in filler- or pigment-containing paints and plastics. Not only suspensions of lighter solids can be stabilized, such as silica-based matting agents, but also heavy anticorrosion pigments such as zinc dust or micaceous iron oxide. Both hydrophilic and hydrophobic pyrogenic silicas can be used as antisettling agents. The most suitable type must be determined for each individual case, whereby additional effects, such as the water repellency of hydrophobic products in corrosion protection systems, must also be taken into consideration [705, 706].

**Dispersants.** In solid-containing liquid systems, pyrogenic silicas reduce the reagglomeration of the solid particles during the dispersion process, whereby a more favorable state of distribution is achieved. This effect is particularly important in pigment-containing systems, where both the gloss and also the tinting strength, and in the case of carbon black pigments also the jetness, can be im-

proved by adding small quantities of pyrogenic silica [705].

**Free Flow Agents.** Some powders exhibit poor fluidity or they agglomerate on storage, particularly under the influence of pressure or moisture. The causes of agglomeration include solid bridges, which form by drying or pressure sintering processes, liquid bridges, electrostatic charging, and van der Waals forces [707, 708]. This can make use of the material difficult or even impossible. In many cases this can be remedied by the addition of hydrophilic or hydrophobic silicas. The reasons for this are complex. Thus, the small silica particles can envelop the powder particles and act as “ball bearings”, hydrophilic pyrogenic silica can adsorb moisture and “render it harmless”, or hydrophobic pyrogenic silica can slow down the absorption of moisture. The significantly smaller silica agglomerates can decrease the van der Waals forces between two powder particles by acting as spacers [708, 709]. Pyrogenic silica is used in fire-extinguisher powders, tablet mixtures, toners, powder coatings, and table salt.

#### Other uses of pyrogenic silica include:

- Adsorbents
- Antiblocking agents for plastic films
- Coatings
- Catalyst supports
- Matting agents

- Grinding agents
- Polishing agents
- Raw materials for silica glasses
- Thermal insulation
- Additive carriers

#### Industrial Hygiene and Safety

Pyrogenic silica does not cause silicosis on inhalation. So far no indication for this illness has been found for those employed in production who undergo regular medical tests [710]. However, since it can lead to irritation of the respiratory tract due to the fine particles, a MAK of  $4 \text{ mg}/\text{m}^3$  total dust in inhaled air was applicable in 1991. This MAK value is not exceeded if suitable precautions are taken, e.g., lowest possible dust development upon handling or extraction of air (ventilation). Otherwise dust masks should be used. According to the findings so far pyrogenic silica is basically harmless by oral intake [711, 712]. Pyrogenic silica can cause a feeling of dryness on the skin, which can be easily remedied by washing and creaming.

Pyrogenic silica is susceptible to electrostatic charging on handling. If it is likely to come into contact with combustible gases or vapors, it is necessary to take the corresponding safety measures, such as careful earthing and utilization of explosion-proof plants.

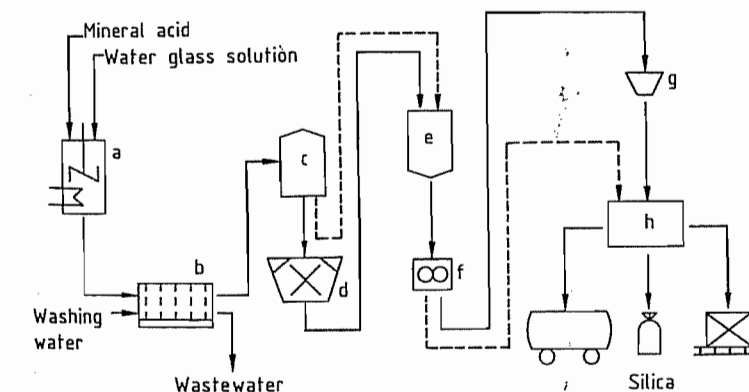
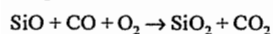
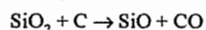

Figure 48.66: Process scheme for the production of precipitated silicas: a) Precipitation; b) Filtration; c) Drying; d) Milling; e) Storage; f) Compacting; g) Granulation; h) Packaging.

### 48.7.6.2 Electric-Arc Process

The reduction of quartz sand with coal in an electric-arc furnace gives gaseous silicon monoxide, which is oxidized to finely divided amorphous silica by atmospheric oxygen [713]:



In a variant of this process the thickening effect of the electric-arc silica is increased by adding steam during oxidation followed by thermal treatment [714].

The matting agent TK 900 used in paints is a silica produced by Degussa using this process.

### 48.7.6.3 Plasma Process

Finely divided amorphous silicas can be produced in plasma burners. In one case quartz sand is reduced to silicon monoxide with methanol at ca. 2000 °C. Subsequently, reduction with steam is carried out [715]. At present such silicas are not available commercially. A schematic of the plasma process can be found in [716].

## 48.7.7 Precipitated Silicas

### 48.7.7.1 Introduction

Precipitated silicas, like pyrogenic silicas and silica gels, are a synthetic, finely divided, white, amorphous form of silicon dioxide. Precipitated silicas have only been produced commercially since the 1940s. In the meantime, they have become the most important group of silica products on the basis of the amounts produced. Worldwide production capacity in 1990 was ca. 800 000 t, compared to ca. 400 000 t in 1970. Capacities in Europe, America, and Asia amount to 340 000, 260 000, and 200 000 t, respectively.

The largest producers worldwide are Degussa, Rhône-Poulenc, Akzo, and Crosfield in Europe, as well as PPG and Huber in the United States. The Asian market is additionally supplied by numerous local producers.

Among these, the companies with the largest capacities are Nippon Silica and Tokuyama Soda in Japan, and Sam Yung and Kofran in Korea.

### 48.7.7.2 Production

Raw materials for the production of precipitated silicas are aqueous alkali metal silicate solutions (e.g., water glass) and acids, generally sulfuric acid [717–732]. Precipitation with hydrochloric acid [733, 734], organohalosilanes [735, 736], carbon dioxide [737, 738], or a combination of the latter with mineral acids [739] are of minor economic importance.

In the reaction of alkali metal silicate solution with mineral acid, the silica precipitates according to the following equation:

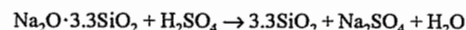

In contrast to silica gels, which are produced under acidic conditions, in this case precipitation is carried out in neutral or alkaline media. The properties of the precipitated silicas can be influenced by the design of the plant equipment and by varying the process parameters.

The production process consists of the following steps; precipitation, filtration, drying, grinding, and, in some cases, compacting and granulation (Figure 48.66).

Numerous possibilities exist for carrying out the precipitation [717–739]. So far only batch precipitation processes have attained economic importance, although continuous precipitations have also been reported [732]. Generally, acids and alkali metal silicate solution are fed simultaneously into water in a stirred vessel with the formation of silica seeds. In the course of the precipitation, three-dimensional silica networks are formed, accompanied by an increase in viscosity. The networks are reinforced by further precipitation of oligomeric silica and grow further into discrete particles with a decrease in viscosity. The formation of a coherent system and thus a gel state is avoided by stirring and increasing the temperature.

The properties of the silica can be influenced by varying important precipitation parameters such as pH, temperature, duration, and solid concentration. Additionally, the rate of addition of the acid and the intensity of stirring, which can be supplemented by a shearing action, also influence the properties of the silica.

The separation of the silica from the reaction mixture and the washing out of the salts contained in the precipitate is carried out in filter aggregates such as rotary filters, belt filters, or filter presses (chamber, frame, and membrane filter presses).

The solids content of the washed filter cake is 15–25% depending on the type of silica and filter, therefore, drying requires the evaporation of large quantities of water. Depending on the desired properties of the end product, drying is carried out in turbine, plate, belt, or rotary driers. Special product properties can be achieved by spray drying the filter cake after redispersion in water or acid [722, 725, 740].

Figure 48.67 shows scanning electron micrographs of a spray-dried, unground silica and a conventionally dried, ground silica.

To control the desired fineness of the particles, various mills and, if required, separators [741] are used. Special degrees of fineness can be achieved by air-jet or steam-jet milling [722, 742]. The silica is separated from the air in cyclones or filters.

Processes for the compression and granulation of precipitated silica have been developed [743, 744] to reduce the volume for transport and for certain uses and also to decrease the formation of dust on handling and processing.

Bags, big bags, containers, or transport silos are used for packaging and shipping. Information about the different methods of packaging and shipping is given in [745]; dust-free handling of precipitated silicas is described in [746]. In Germany the general dust limit of 4 mg total dust/m<sup>3</sup> air must be adhered to when handling precipitated silicas. Similar regulations apply in other countries.

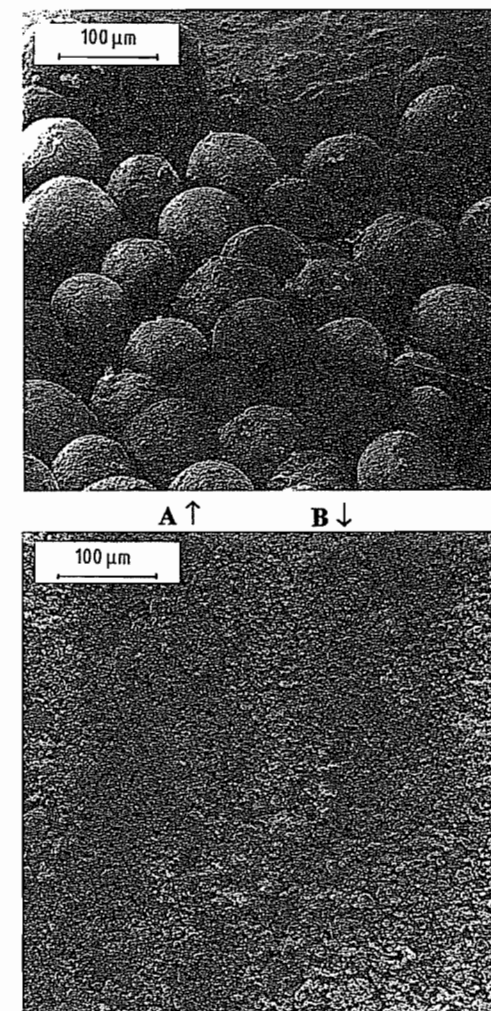

Figure 48.67: REM photographs of precipitated silicas. A) Spray-dried unground silica; B) Conventionally dried, ground silica.

### 48.7.7.3 Properties

#### Physicochemical Properties

Precipitated silicas consist mainly of spherical primary particles, generally intergrown in three-dimensional aggregates. These aggregates can pack together to form larger agglomerates. The terms primary particle,

agglomerate, and aggregate are defined in DIN 53206.

Some important physicochemical properties of several precipitated silicas are listed in Table 48.24.

The specific surface area is generally determined by the BET method (DIN 66131), which measures both the outer surface and the surface of accessible pores. The specific surface area is of importance especially in reinforcement and adsorption applications. Precipitated silicas can be produced with specific surface areas of 25–800 m<sup>2</sup>/g.

The mean agglomerate size is important in the use of precipitated silicas as flattening or antiblocking agents for paint systems and plastic films. The agglomerate size can be determined by various methods either on the powder or after incorporation in a medium (e.g., water, paint, silicone rubber) [747].

The tapped density (DIN ISO 787/11) is a measure of the weight of the powder and thus gives indications of the spatial requirement for transportation and a general guide for han-

dling. The tapped densities of precipitated silicas lie in the range 50–500 kg/m<sup>3</sup>.

The loss on drying (DIN ISO 787/2) includes the majority of the water physically bound to the silica and for precipitated silicas generally lies between 2.5 and 7% (on leaving the supplier).

The loss on ignition (DIN 55921) includes the additionally chemically bound water (a siloxane group is formed from two neighboring silanol groups with the loss of a water molecule). Ignition losses for precipitated silicas generally lie between 3 and 7%.

Generally the pH value (DIN ISO 787/9) of precipitated silicas is ca. 7.

The dibutyl phthalate (DBP) absorption (DIN 53601) is a measurement of the adsorptive capacity and for precipitated silicas lies in the range of 175–320 g/100 g. The absorptive capacity is important for the conversion of liquids and pastes into powders.

The determination of the sieving residue (DIN ISO 787/18) provides an indication of the amount of difficultly dispersible fractions in a precipitated silica.

Table 48.24: Physicochemical data and chemical composition of several precipitated silicas.

|   | Sident<br>12 DS | Utrasil VN 3 | Sipernat 22         | Sipernat<br>50 S | Intergarant<br>Super 90 | OK 412 <sup>a</sup> | Sipernat <sup>b</sup><br>D 17 |
|---|-----------------|--------------|---------------------|------------------|-------------------------|---------------------|-------------------------------|
| Appearance                                      | ←               |              | fluffy white powder |                  |                         |                     | →                             |
| Behavior toward water                           | ←               |              | hydrophilic         |                  |                         |                     | → hydrophobic                 |
| BET surface area, m <sup>2</sup> /g             | 80              | 170          | 190                 | 450              | 700                     |                     | 100                           |
| Mean agglomerate size, μm                       | 6 <sup>c</sup>  |              | 100 <sup>d</sup>    | 8 <sup>e</sup>   |                         | 3 <sup>e</sup>      | 10 <sup>f</sup>               |
| Tapped density, g/L                             | 200             | 260          | 270                 | 100              | 180                     | 120                 | 150                           |
| Loss on drying <sup>g</sup> , %                 | 6               | 6            | 6                   | 6                | 6.5                     | ca. 5               | 3                             |
| Ignition loss <sup>h,i</sup> , %                | 4               | 5            | 5                   | 5                |                         | ca. 11.5            | 7                             |
| pH value <sup>j</sup>                           | 6.5             | 6.3          | 6.3                 | 6.5              | 6.0                     | ca. 0.6             | 8 <sup>b</sup>                |
| DBP absorption <sup>k,i</sup> , g/100 g         |                 |              | 260                 | 330              |                         |                     | 230                           |
| SiO <sub>2</sub> <sup>l</sup> , %               | 98              | 98           | 98                  | 98.5             | 99                      | ca. 99              | 99.5                          |
| Na <sub>2</sub> O <sup>l</sup> , %              | 1               |              | 1                   | 0.6              |                         |                     | 0.2                           |
| Fe <sub>2</sub> O <sub>3</sub> <sup>l</sup> , % | 0.03            | 0.03         | 0.03                | 0.03             |                         |                     | 0.03                          |
| SO <sub>3</sub> <sup>l</sup> , %                | 0.8             |              | 0.8                 | 0.7              |                         |                     | 0.1                           |
| Sieve residue <sup>f</sup> , %                  |                 |              | 0.5                 | 0.1              |                         |                     | 0.1                           |

<sup>a</sup> Flattening agent.

<sup>b</sup> In water: methanol 1:1.

<sup>c</sup> Coulter Counter, capillary 100-μm.

<sup>d</sup> Alpine air-jet sieve.

<sup>e</sup> Determined from SEM photos.

<sup>f</sup> DIN ISO 787/18.

<sup>g</sup> DIN ISO 787/2.

<sup>h</sup> DIN 55921.

<sup>i</sup> Relative to substance dried for 2 h at 105 °C.

<sup>j</sup> DIN ISO 878/9.

<sup>k</sup> DIN 53601.

<sup>l</sup> Relative to substance heated for 2 h at 1000 °C.

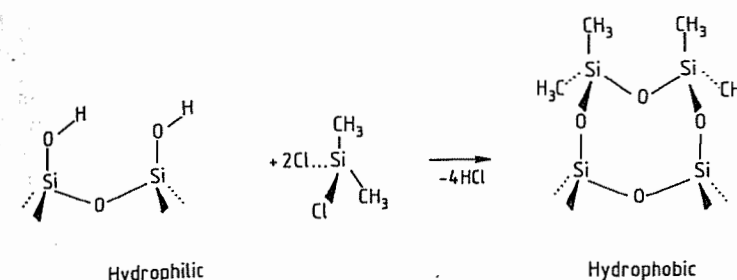

Figure 48.68: Schematic of the reaction of the surface silanol groups of a precipitated silica with dimethyldichlorosilane.

### Surface Chemistry and Surface Modification

Precipitated silicas have two different functional groups on their surfaces: silanol (Si-OH) groups and siloxane (Si-O-Si) groups.

These two groups substantially influence the surface properties and hence the application properties of precipitated silicas. The surface has 5–6 silanol groups per nm<sup>2</sup>, which results in the hydrophilic character of precipitated silicas. Whereas the siloxane groups are generally chemically inert, the reactivity of the silanol groups allows chemical surface modification [748] of precipitated silicas. Thus, the reaction with organosilanes [749–751] or silicone fluids [752, 753] leads to hydrophobic precipitated silicas.

Hydrophobization is carried out industrially both by wet processes (e.g., addition of organochlorosilane to the precipitate suspension; see Figure 48.68) and dry processes (e.g., the reaction of precipitated silicas with silicone fluids).

In coating processes, in contrast, no chemical reaction takes place; the coating agents are adsorbed on the silica surface. Wax coating with wax emulsions has become industrially important [722, 754, 755]. Surface modification is advantageous for certain applications (e.g., free flow agents, defoamers, and flattening agents; see Section 48.7.7.4).

### Chemical Composition and Analysis

The chemical composition of precipitated silicas (Table 48.24) is generally less impor-

tant than the physicochemical data with regard to the application properties. Furthermore, commercially available precipitated silicas differ only slightly in their composition.

The SiO<sub>2</sub> content is determined gravimetrically by fuming with hydrofluoric acid (DIN 55921); the analysis of the metal-containing impurities is performed by atomic absorption spectrometry (AAS). The sulfate content is determined by complexometric titration (DIN 38405/5), colorimetric titration (DIN 2462/8), or potentiometric titration.

The carbon content of modified silicas is determined by converting the carbon-containing component into CO<sub>2</sub>.

A survey of the chemical analysis of precipitated silicas is given in [756].

### 48.7.7.4 Uses

Precipitated silicas can be tailor-made to meet the requirements of various uses. Only the most important of the numerous applications (Figure 48.69) are mentioned here.

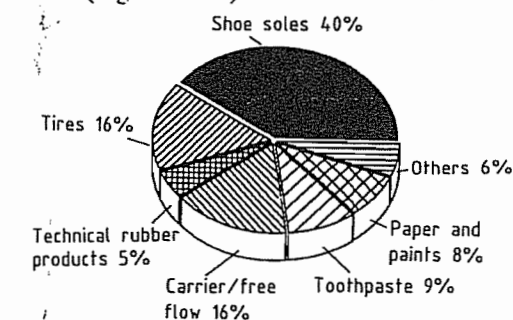

Figure 48.69: Worldwide consumption and use of precipitated silica in 1990.

The oldest and most important use of precipitated silicas is the reinforcement of elastomer products such as shoe soles, technical rubber articles, cable, and tire compounds [757, 758].

The addition of 20–100 parts by weight of precipitated silica to 100 parts by weight of natural or synthetic rubber improves the tensile strength, hardness, tear strength, and abrasion resistance of the vulcanized material [759]. Furthermore, special precipitated silicas enable the production of transparent vulcanized materials.

The reinforcing effect of precipitated silicas is superior to that of natural or mineral fillers and, in contrast to carbon blacks, they allow the production of white and colored rubber articles.

In cables, they are used mainly in sheathing compounds for cables that are not fixed and must be differentiated from the background by a colored exterior (e.g., mining or excavator-hauling cables). The high resistance of the cable sheath to friction and tearing protects the inside of the cable from abrasion and damage [760].

A further important use of precipitated silicas is as reinforcing materials in tires. Furthermore, they are constituents of certain adhesive systems for the bonding of unvulcanized rubber to textiles (nylon, polyester) or steel tire cord.

In more recent developments, sulfur-containing bifunctional silanes are used to form covalent bonds between the silica filler and the unvulcanized rubber. The improved static and dynamic properties are being increasingly exploited in tire compounds for the running tread, side walls, and carcasses of highly stressed special tires [761–763].

Precipitated silicas are also used as reinforcing fillers in silicone rubber [764, 765], where they replace the more expensive pyrogenic silicas in certain formulations.

In thermoplastics, precipitated silicas are used to improve specific properties. They act as antiblocking agents and are used to prevent plate-out effects in films and film production.

They are also used to improve the mechanical properties of PVC flooring [766, 767].

A further major application is the use as carrier silicas for materials and as free flow agents for powder formulations, particularly of hygroscopic and adhesive substances. Of particular importance is high adsorptivity and good flowability of the silica, which can be achieved, for example, by spray drying.

Such precipitated silicas absorb liquids or solutions to give powder concentrates that contain up to 70% of the liquid [768]. In this way liquid materials are converted into a dry, free-flowing form, which can be mixed in any ratio with other dry substances. This is of particular importance in the animal-feed industry for the mixing of feed additives [769]. Materials converted into powder form include: choline chloride, ethoxyquin, molasses, and vitamin E acetate [770]. Fats can be converted into free-flowing powders for use as milk-substitute feeds [768, 770], mainly for the fattening of calves.

Precipitated silicas are used as carriers for crop protection agents and insecticides [771], in toothpastes as cleaning agents, since they clean effectively with a minimum of scratching [772, 773].

The surfaces of objects are matted for reasons of fashion but also to increase safety by avoiding dazzle. Special silica products have been developed for matting of paints and varnishes [722, 741, 755]. The matting effect is the result of roughening of the surface on the microscopic scale, whereby the light is diffused and no longer directionally reflected.

In the paper industry precipitated silicas are used in the production of special papers to ensure high depth of color and good contrast of the printed papers [774]. Here the silica fills the pores of the paper and gives a smooth surface.

Particularly, hydrophobic precipitated silicas are used increasingly in mineral-oil and silicone-oil antifoam agents to increase the antifoaming effect [775]. They are used as foam regulators in laundry detergents [776].

Further uses for precipitated silicas include additives in rolled asphalt and asphalt mastic

to increase the dimensional stability [777, 778], the purification and stabilization of beer [779], and the analysis of blood [780].

## 48.7.8 Porosils

### 48.7.8.1 Introduction

Porosils are crystalline porous silicas of the general composition  $\text{SiO}_2 \cdot M$ , where M is an organic or inorganic guest molecule residing within the pores of the silica host framework. R. M. BARRER coined the name porosils to differentiate between porous aluminosilicate zeolites and a new class of compounds of distinct composition [781]. Due to their porous crystal structure porosils have properties similar to the zeolites; however, differences in chemical composition are responsible for their specific properties in catalysis, sorption, and molecular sieving.

Work in the field was initiated in 1978 by FLANGAN et al. [782] who reported on the synthesis and crystal structure of the siliceous analogue of the commercially most important zeolite ZSM-5.

The guest species M can be expelled by thermal treatment to give the pure silica form of the porosil. Therefore, porosils are considered to be the porous polymorphs of the structure family  $\text{SiO}_2$ . Up to now, 24 porosil structure types have been made, either by template-directed synthesis or post-synthesis treatment of aluminosilicate zeolites [783]. In the synthesis of porosils the guest species M act as templates for the pores, defining their size and geometry [784]. During the post-synthesis treatment framework aluminum is substituted by silicon, and M is atmospheric gases or sorbate molecules [785].

Porosils are subdivided into zeosils and clathrasils according to the pore structure of the silica framework. Zeosils have channel-type pores with pore openings larger than 0.4 nm (Figure 48.70). The channels may intersect to give a two- or three-dimensional pore system. Clathrasils have cage-type voids with pore openings much smaller than the free di-

ameter of the cage and less than 0.45 nm (Figure 48.70).

With the exception of melanophlogite, a rare mineral formed by low-temperature, low-pressure metamorphism in, e.g., serpentine veins [786], all porosil structure types are synthetic materials. The ever increasing number of new porosil structure types reflects the efforts in the systematic investigation of the mechanism of formation of zeolites, for which porosils represent a simplified system. Besides porosils, water (clathrate hydrates),  $\text{AlPO}_4$  (AIPO's),  $\text{GaPO}_4$ , and other III–V oxides (e.g., arsenates) also form neutral inorganic porous framework structures when synthesized in the presence of structure-directing guest molecules [783].

### 48.7.8.2 Physical and Chemical Properties

The physical and chemical properties of porosils are closely related to their crystal structure and composition. Porosils are colorless materials of hardness close to that of quartz. Since they are framework silicas, they exhibit no pronounced cleavage. Refractive indices vary systematically with the density of the silica framework [787]. This confirms that the nature of the Si–O bond accounts for most of the physical properties and is closely related to the natural polymorphs of the  $\text{SiO}_2$  structure family. The porosils are thermodynamically metastable and transform reconstructively to cristobalite at high temperature (e.g., melanophlogite:  $T > 950^\circ\text{C}$  [788]).

Below  $200^\circ\text{C}$  structural phase transitions to lower symmetry space groups have been reported for melanophlogite [789], dodecasil 3 C [790], decadodecasil 3 R [791], silica-ZSM-5 [792], and silica-ZSM-11 [793].

For dodecasil 3 C, three consecutive phase transitions have been reported, with transformation from cubic to tetragonal, orthorhombic, and finally monoclinic symmetry [794]. This reflects the flexibility of the silica framework. Several phase transitions are ferroic (e.g., ferroelastic) indicating interesting physical properties for the material.

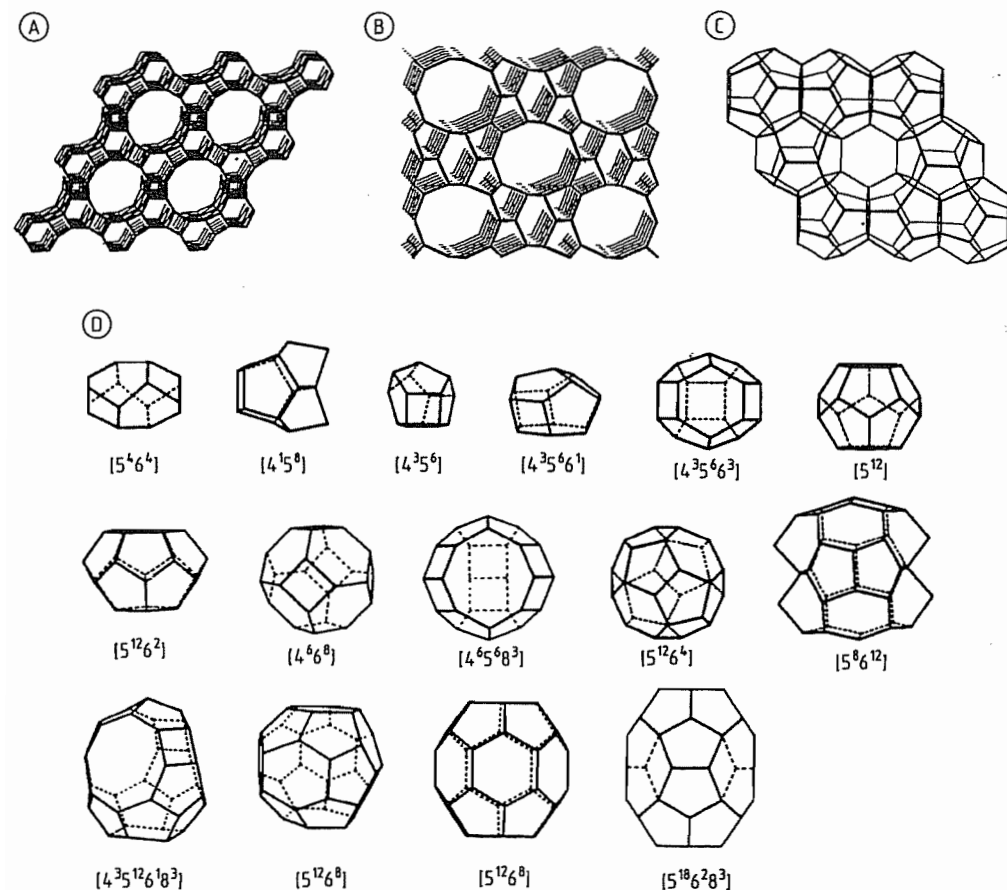

**Figure 48.70:** Skeletal projections of porous framework structures. Si atoms are located in the nodes of the framework O atoms, which are close to the midpoint between 2 Si atoms, but are omitted for clarity. A) Projection of the AFI structure along the channel axis. The channel pore opening is confined by 12 Si atoms (12 MR); B) Projection of the FER, TON, MTT, MEL, and MFI structures along the straight channel axis. The channel pore opening is confined by 10 Si atoms (10 MR); C) Projection of the dodecasil layer. Pentagonal dodecahedra are arranged in layers which are the basic structural feature of DOH, MTN, DDR, and decadodecasil 3 H; D) Compilation of types of cage as found in clathrasil structure types ( $[5^{12}]$  represents pentagonal dodecahedron, i.e., 12 five-membered rings).

Since the composition of the host framework is  $\text{SiO}_2$ , porosils are electroneutral. The pores, therefore, contain only electroneutral guest species (i.e., ion pairs, molecules, and/or atoms). In contrast to aluminosilicate zeolites, porosils are hydrophobic [782, 795], preferentially sorbing aprotic organic molecules. The weak Lewis acidity of the electroneutral  $\text{SiO}_2$  framework of the porosils reduces considerably their potential as materials for heterogeneous acid catalysis, for which the isostructural aluminosilicate zeolites are

widely used [796]. The pore geometry of the porous structure types varies from zero-dimensional pores (i.e., cavities) to three-dimensional pore systems (i.e., intersecting channels). The pore openings are confined by  $[\text{SiO}_4]$  units arranged in a ring (Figure 48.70) (e.g., ten-membered ring, 10 MR: 10  $\text{SiO}_4$  units per ring). In general the sorption properties of the materials are related to the largest pore opening of the structure, which provides for the release of guest molecules and the access of sorbates to the internal surface. In

clathrasils the maximum pore opening (6–8 MR) is too small for the exchange of the occluded species. The template-free material can be obtained only by calcination at  $> 600^\circ\text{C}$ . For 6 MR as maximum pore opening only very small atoms or molecules such as  $\text{H}_2$  or He could be sorbed onto the silica framework. Zeolites with pore openings of 8–12 MR are calcined at lower temperatures and could be used for the selective sorption of, e.g., *n*-alkanes (8 MR materials) or *p*-substituted aromatic compounds (10 MR materials). Because of the uniform character of the pore opening and the possibility of tailoring the size of the pores, porous membranes, such as those already available for zeolites, could be useful for separation processes [797].

### Zeolites

Physical and chemical properties specific to zeolites are related to their crystal structure. The channel-like pores allow access to the internal surface of the material for sorbates that meet the geometrical requirement of the pore window.

The free diameter of the individual materials, however, varies considerably due to the flexibility of the silica framework. Because of the hydrophobic properties of the silica framework and the geometry of the internal pore system, zeolites are of particular interest for various applications. In the presence of water zeolites sorb selectively hydrophobic organic molecules in the vapor and liquid phase [798]. Sorption of monomers into the silica framework followed by polymerization leads to one-, two-, or three-dimensional polymeric filaments inside the zeolite framework, as already demonstrated for zeolites [799]. The deposition of semiconducting materials [800] and metal atom clusters [801] inside, e.g., the zeolite cavity of silica-A or silica-faujasite creates new materials with interesting properties due to the limited size of crystallites built within the pores. The sorption of polar organic molecules such as *p*-nitroaniline also leads to changes in symmetry and polarization of the host-guest composites, leading, e.g., to non-

linear optical properties [802]. For a review on new applications of zeolites, see [803].

### Clathrasils

The clathrasil structure types have cage-like pores. Species inside the cavities are too large to pass through the 4 MR, 5 MR, 6 MR, or 8 MR windows without their decomposition. In general, clathrasils in the as-synthesized form have no exchange capacity or sorption properties. After calcination at high temperature ( $> 600^\circ\text{C}$ ) the decomposition of the guest species may lead to a guest-free porous silica with very narrow pores that is suitable for sieving and sorption processes. The properties of clathrasils are, therefore, linked to properties introduced by the guest molecules clathrated in the formation process. Because of the high thermal and chemical stability of the silica host framework, clathrasils have been proposed as containers for radioactive gases (e.g., krypton) [804]. The synthesis of the clathrasil dodecasil 3 C with a number of nonglobular guest molecules leads to a distortion of the cubic symmetry of the silica framework. At room temperature the materials have acentric symmetry and, therefore, nonlinear optical properties [805]. The temperature of the phase transition to the acentric space group depends on the nature and the concentration of the guest molecule in the silica framework and is in the range between slightly below room temperature and ca.  $200^\circ\text{C}$ .

### 48.7.8.3 Manufacture of Porosils

With the exception of melanophlogite, all porous structure types are synthetic materials made directly from an active form of  $\text{SiO}_2$  or by dealumination of high-silica zeolites.

### Synthesis of Porosils

Structure-directing templates play a key role in the synthesis of porous silicas [806]. Since the templates are occluded within the pores during synthesis, it is their size and shape which determine the size and shape of the pores of the silica framework. Organic

amines have proved to be the most efficient templates. Up to now ca. 100 different molecules have successfully been used for the synthesis of porosils [806–808]. Globular species such as xenon, quinuclidine, and 1-aminoadamantane preferentially stabilize the cage-like voids characteristic of clathrasils. Chain-like amines such as the  $\alpha,\omega$ -diamines of propane, butane, pentane, etc., stabilize channel-like voids. The size of the pore depends on the size of the template. Whereas pyrrolidine leads to preferential formation of dodecasil 3 C by occupying a 16-hedral cage, 1-aminoadamantane is occluded within a 20-hedral cage in dodecasil 1 H. Zeosil structure types with 10 MR channels are formed in the presence of aliphatic chain-like templates ( $\alpha,\omega$ -diamino-*n*-alkanes); 12 MR channels are formed with molecules containing sequences of *p*-substituted heterocycles (e.g., 4,4'-trimethylenedipiperidine).

### Dealumination of Aluminosilicate Zeolites

Aluminum is selectively extracted from the silicate framework and replaced by silicon [809]. The dealumination procedure includes successive chemical and hydrothermal treatment of the material in order to extract and remove the framework aluminum atom. A typical procedure is the calcination of the synthesis product at 300–500 °C to expel the organic template, exchange of the cations with ammonium, and steaming at ca. 600 °C to remove the aluminum.

### Formation of Melanophlogite

So far melanophlogite is the only known natural porosil. In synthesis experiments the conditions of formation have been simulated and are of low temperature (ca. 100–200 °C) and low (autogenic) pressure. The material has been described as a trace occurrence from five localities in very different geological settings. However, the nature of the porosil structure types and the wide range of structural features suggest that further natural variants

may exist, especially in hydrothermally active areas (e.g., geysers).

## 48.7.9 Toxicology

The effect of the dust that arises when working with silica is of primary importance from a toxicological point of view, especially in the case of long-term exposure of several hours per day. This applies to naturally occurring and synthetic as well as to crystalline and amorphous. As far as industrial medicine is concerned, local contact with the skin and mucous membranes is important. In the case of inhalation of the dust, the effect on the respiratory tract is significant.

The effect of silica-containing dust on the respiratory tract depends on:

- The physical and chemical properties (e.g., the particle or primary particle size and the specific surface area)
- The concentration administered
- The daily and total duration of exposure

### 48.7.9.1 Experiences with Humans

After long-term exposure at work, the effects of crystalline or amorphous SiO<sub>2</sub> dust on the respiratory tract of humans are well known and have been widely reported (for reviews, see [810–813]).

**Crystalline Silica Dust.** The classification into common, accelerated, and acute forms of silicosis [810] is based on the time interval between the beginning of exposure to silica and the first appearance of silicotic changes that are detectable in a X-ray picture. A rapid manifestation and an accelerated course of the disease are caused primarily by long-term inhalation of higher concentrations of SiO<sub>2</sub> dust.

The common form of silicosis (simple silicosis) occurs röntgenologically after about twenty or more years of exposure. The content of crystalline SiO<sub>2</sub> in the dust that causes silicosis in workers is often less than 30% [810].

The accelerated form of silicosis (5–15 years) develops after a shorter exposure to

higher concentrations of SiO<sub>2</sub> dust. Progressive massive fibrosis is often observed on the X-ray picture [810].

The acute form, also known as silicoproteinosis, develops in 1–3 years. The clinical symptoms include rapidly deteriorating function of the lungs, which is always fatal.

The progression of silicosis even after the termination of exposure is especially characteristic, and there is still no effective treatment.

For this reason, it is essential that the legal regulations for working with crystalline SiO<sub>2</sub> are obeyed [814–816].

**Amorphous Silica Dust.** *Amorphous Synthetic Silica.* From experimental long-term inhalation tests on rats, it is known that high concentrations of some synthetic amorphous silicas can cause nodular (fibrotic) changes in the lungs of the animals during the exposure phase [817]. However, the regression of the nodules (fibrosis) in the lungs after the termination of the exposure phase is characteristic of the biological action of these amorphous silica dusts. In a treatment-free, follow-up observation phase of several months, a clear time-dependent regression of the changes in the lungs of the experimental animals could be detected after three, eight, and up to twelve months (see below) [817, 818]. In the case of the neighboring lymph nodes, the regression of the morphological changes observed within the inhalation phase was established histologically [817, 818].

In-depth investigations carried out by company doctors over periods of up to 12 years [819] and from 1 to 32 years [820] have confirmed that until now long-term contact with amorphous synthetic silicas has not resulted in a single case of silicosis.

Established MAK [815] and TLV regulations [816] must be complied with when working with amorphous synthetic silicas. If these fixed limiting values are exceeded—especially for a longer period of time—an overtaxing of the respiratory passages and a corresponding biological defence reaction in

the bronchial tubes and, especially, in the lung tissue must be expected.

VITUMS et al. observed that fibrosis of the lungs was caused by exposure to flue dust containing silica with a wide particle-size distribution, such that as produced in the manufacture of ferrosilicon or quartz glass [821].

*Amorphous Natural Silicas.* A distinction is made between exposure to amorphous synthetic silica dust and exposure to natural amorphous silica dust (kieselguhr). The latter can contain small amounts of crystalline SiO<sub>2</sub> and, according to some studies, can cause silicosis in humans on long-term exposure [811].

### Carcinogenicity of Silica Dusts in Humans.

In many cases, industrial workers exposed to silica dust exhibit a higher incidence of lung cancer. However, exposure to silica dust is often complicated by other hazards such as polycyclic aromatic hydrocarbons, asbestos, and smoking, which makes a causal analysis extremely difficult. According to GOLDSMITH et al. [822], at least two studies show a strong association between silicosis and lung cancer: the analysis of the Swedish pneumoconiosis register by WESTERHOLM [823] and a similar study by FINKELSTEIN [824] in Ontario, Canada. However, the same authors [822] also stated that a completely convincing causal relationship cannot be concluded. A possible association between silicosis and lung cancer is also discussed in [825], based on data from a clinical cancer monitoring register. A relationship between tumors of the upper intestinal tract and the ingestion of quartz particles in food in North China has been suggested [826]. A correlation was made between the incidence of cancer of the esophagus and the consumption of plant products that contain silica fragments and fibers for a region in North China, in northeast Iran, and in Transkei.

### 48.7.9.2 Animal Experiments

**Long-Term Inhalation of Silica Dust.** In specifically designed, practice-oriented long-term inhalation studies, various types of crystalline

and amorphous silica dust have been thoroughly tested on rodents. Rats [817, 818, 827, 828] were mainly used, but rabbits [818, 829, 830] and guinea pigs [818] were also employed.

The elimination rate in rats has been determined in an inhalation experiment with amorphous highly disperse silica. In the case of Aerosil 200, for example, after the termination of inhalation, 65–75% of the dust was eliminated in one month, 80–90% in two months, and 95% in three to five months. It is possible that the rate of solubilization of these hydrophilic silicas also plays a role [817].

It was found in retention studies on rats [817] that in the case of longer term inhalation (28 times four hours in 36 days) of highly disperse amorphous silica dust, the continuous elimination during the exposure phase is very high. This means that the formation of large  $\text{SiO}_2$  deposits in the lungs is improbable [817]. In contrast, in long-term inhalation experiments with quartz dust the tendency towards formation of deposits was higher [817].

After the termination of a long-term inhalation study on rats with Aerosil 200 (12 months, 4 per day; concentration:  $45 \text{ mg/m}^3$ ), some of the animals were subjected to treatment-free observation for another 3 to 8 months and then killed [817]. Subsequently, a histological investigation and chemical analysis of  $\text{SiO}_2$  in the lungs and lymph nodes were performed. In the follow-up observation period, it was found that the nodules in the lungs were reduced to small residual foci. The lymph nodes, which were still enlarged after three months, had greatly regressed after eight months. Similar observations have also been made in previous inhalation experiments with Aerosil.

In a long-term inhalation experiment on rats with quartz [828] (12 months, 5 per day, 5 per week; concentration:  $10 \text{ mg/m}^3$ ; standard quartz No. 12, Dörentrup quartz), some of the animals were subjected to treatment-free observation for another 4 weeks to 6 months after the termination of exposure and then killed. In this follow-up observation period, it was possible to detect silicotic reactions in the

lungs and reticulohistiocytic cells typical of quartz in the lymph nodes. There was an increase in the silicotic nodules in the lungs after six months and fibrosis of the mediastinal lymph nodes had clearly increased.

Examination of lungs and accompanying lymph nodes of the individual groups of animals at various time intervals showed that in the case of quartz, a long residence time in the lungs must always be expected, but that deposits of finely divided amorphous silica are relatively quickly and extensively eliminated [817, 828]. This is true of amorphous silicas with a specific surface area of  $> 100 \text{ m}^2/\text{g}$  [817].

**Injection of Silica Dust.** The tissue reaction typical of a particular silica dust can be determined in animal experiments by means of a single intratracheal or intraperitoneal injection.

The intratracheal injection of a high dose of quartz resulted in a massive local accumulation of dust [828]. The tissue reaction caused by an injection of this type is similar to the picture of acute silicosis. Fast reactions of this kind in the lung tissue—comparable with the exposure of workers to high concentrations of quartz [819]—can also be produced in animal experiments with very high inhalation concentrations ( $400 \text{ mg/m}^3$ ) [828].

The general effect of a particular dust (acute toxicity) and the local harmful (cytotoxic) effects are deduced from the tissue reaction observed in rats after intraperitoneal  $\text{SiO}_2$  injections. Cytotoxicity can occur in the form of nodular fibrosis (dust nodules) or surface fibrosis that leads to extensive coalescence of the abdominal organs [817].

The reaction of lung tissue on longer term inhalation of  $\text{SiO}_2$  dust cannot be directly inferred from the results of the intratracheal and intraperitoneal injections. Thus, the physiologically important reactions of the organism in the course of  $\text{SiO}_2$  retention and  $\text{SiO}_2$  elimination can be determined only in long-term inhalation tests with a sufficiently long, treatment-free, follow-up observation period.

The morphological changes in the lungs after long-term inhalation of natural crystalline  $\text{SiO}_2$  progress after the termination of exposure, whereas with synthetic amorphous silica dust the morphological changes regress after the termination of exposure (reversibility).

**Carcinogenicity of Silica Dusts in Animal Tests.** Lymphomas have been found in rats after intrapleural, i.p., i.v., and direct application in the thymus gland of various silica modifications [831, 832]. The tumor incidence differed for various species of rat, and no tumors were observed in mice and hamsters. A synergistic effect has been reported for silica dust and benzo[a]pyrene [833], as has been found for other dusts (e.g., coal,  $\text{TiO}_2$ ). This is presumably the result of chemico-physical surface effects, which may also be involved in tumor promotion. Tests have shown that Min-U-Sil causes tumors in rats in the intratracheal test [834]. Tissue scarring has been discussed as the cause. Min-U-Sil strongly fibrogenic and extremely finely divided.

## 48.8 References

1. *Properties of Silicon*, EMIS Datareviews Series No. 4, INSPEC, London 1988.
2. *J. Phys. Chem. Reference Data* 14 (1985) 1.
3. L. P. Hunt, V. D. Dosaj, J. R. McCormick, *Quart. Rep. DOE/JPL-95 4559-76/2* 1977, Jan.
4. Dow Corning, DE-OS 3013319, 1979 (V. D. Dosaj, L. P. Hunt).
5. J. Dieltl, D. Helmreich, E. Sirtl: *Crystals*, vol. 5, Springer-Verlag, Berlin 1981, p. 43.
6. A. Sanjurjo et al., *J. Electrochem. Soc.* 128 (1981) 179.
7. L. Nanis et al.: *Final Rep. DOE/JPL-95 4471* 1980, March.
8. Ethyl Corp., EP-A 0112151A1, 1984 (E. M. Marlett).
9. Siemens & Halske, DT 1102117, 1954 and DT 1140549, 1954. Siemens-Schuckertwerke, US 3042494, 1958 and 1962 (H. Gutsche).
10. E. Sirtl: *Festkörperprobleme VI*, Pergamon-Vieweg, Braunschweig 1967, p. 1.
11. Ethyl Corp., US 4784840, 1988 (M. F. Gautreaux, R. H. Allen); US 4820587 and 4883687, 1989 (M. F. Gautreaux, R. H. Allen).
12. KRICT, US 4900411, 1990 (Y. Poong, S. Yongmok).
13. Texas Instruments, US 3963838, 1976 (H. S. N. Setty, C. L. Yaws, B. R. Martin, D. J. Wangler).
14. J. Czochralski, *Z. Phys. Chem.* 92 (1917) 219.
15. W. Zulehner, D. Huber: *Crystals*, vol. 8, Springer-Verlag, Berlin 1982, p. 1.
16. W. Zulehner in *Materials Science Engineering*, vol. B4, Elsevier Sequoia, Lausanne 1989, p. 1.
17. W. Zulehner in K. Sumino (ed.): *Defect Control in Semiconductors*, Elsevier Science, North Holland 1990, p. 143.
18. S. B. Kulkarni in N. G. Einspruch, G. B. Larrabee (eds.): *VLSI Electronics: Microstructure Science*, vol. 6, Academic Press, New York 1983, p. 73.
19. T. L. Chu in N. G. Einspruch (ed.): *VLSI Handbook*, Academic Press, New York 1985, p. 285.
20. H. Herzer, *Proceedings of the 10th European Photovoltaic Solar Energy Conference*, Lisbon, Portugal, April 1991, p. 501.
21. New Energy Development Organization (NFDO, Japan), Report no. 1, 1990; *Photovoltaic Insider Report (PVIR)* 2 (1991).
22. S. Wagner, D. E. Carlson in [20], p. 1179.
23. N. B. Mason, D. Jordan in [20], p. 280.
24. M. A. Green in [20], p. 250.
25. A. Eyer, A. Rüber, A. Goetzberger, *Optoelectronics—Devices and Technologies* 5 (1990) no. 2, 239.
26. A. Stock: *Hydrides of Boron and Silicon*, Ithaca, New York 1933; *Z. Elektrochem.* 32 (1926) 341.
27. A. G. McDiarmid, *Quart. Rev.* 10 (1956) 208.
28. *Gmelin*, System. no. 15, part B, 227ff.
29. A. Stock, C. Somieski, *Ber. Dtsch. Chem. Ges.* 49 (1916) 125, 155.
30. H. J. Emeleus, A. F. Maddock, *J. Am. Chem. Soc.* (1946) 1131.
31. H. Clasen, *Angew. Chem.* 70 (1958) 179.
32. W. C. Johnson, S. Isenberg, *J. Am. Chem. Soc.* 57 (1935) 1349.
33. A. E. Finholt, A. C. Brown, K. E. Wilzbach, H. I. Schlesinger, *J. Am. Chem. Soc.* 69 (1947) 2692.
34. Internat. Standard Electric Corp., US 2888328, 1956.
35. Kali-Chemie, DT-1034159, 1956; DE-AS 1049835, 1956.
36. Allied Chem. Corp., DT 1080531, 1959.
37. Standard Telephone & Cables, GB 832333 and 832334, 1956.
38. W. Sundermeyer, O. Glemser, *Angew. Chem.* 70 (1958) 625.
39. Ethyl Corp., EP 300320, 1989 (J. A. Bossier, D. M. Richards, L. T. Crasto).
40. Ethyl Corp., US 4778668, 1988 (E. M. Marlett, R. N. DePriest).
41. Union Carbide, CA 1151305, 1983 (W. C. Breneman).
42. Tokuyama Soda, JP 59174516, 1984.
43. Union Carbide, CA 1184017, 1985 (W. C. Breneman, L. M. Coleman).
44. Tokuyama Soda, JP 60060917, 1985.
45. Solavolt International, US 4542004, 1985 (K. R. Sarma, C. S. Chanley).
46. J. Moriyama: "Production of High-Purity Silicon. A Review", *Suiyokaiishi* 20 (1988) no. 10, 671–679.
47. Mitsui Toatsu Chemicals, JP 58156522, 1983.
48. Toa Gosei Chemical, JP 01234316, 1989 (S. Watanabe, T. Hattori).
49. Toa Gosei Chemical, JP 61191512, 1986 (O. Hirano et al.).
50. Bell Telephone, BE 566348, 1960.



51. Licentia Patentverwertung, DT 1073460, 1958.
52. V. V. Balabanov et al., *Vysokochist. Veshchestva* 6 (1990) 60-66.
53. Toshiba Corp., JP 58048417, 1983.
54. Seiko Instruments and Electronics, JP 63132420, 1988 (N. Shimizu, M. Shinho).
55. Canon, DE 3208494, 1982 (I. Shimizu, K. Ogawa, E. Inoue).
56. S. W. Depp, W. E. Howard, *Spektrum der Wissenschaft* 1993, 547.
57. Bell Laboratories, US 4579752, 1986 (L. H. Dubois, R. G. Nuzzo).
58. J. R. Hartmann, J. Famil-Ghirriha, M. A. Ring, H. E. O'Neal, *Combust. Flame* 68 (1987) no. 1, 43-56.
59. Pioneer Electric Corp., JP 61090726, 1986 (K. Kitahara, T. Shimada).
60. A. Y. Adamova et al., *Kim. Iys. Energ.* 15 (1981) no. 4, 365-369.
61. C. B. Moore, J. Biedrzycki, F. W. Lampe, *J. Am. Chem. Soc.* 106 (1984) no. 25, 7761-7765.
62. T. N. Bell, K. A. Perkins, P. G. Perkins, *J. Chem. Soc. Chem. Commun.* 1980, no. 22, 1046-1047.
63. H. Buff, F. Wöhler, *Liebigs Ann. Chem.* 104 (1857) 94.
64. G. Braver: *Handbuch der präparativen anorganischen Chemie*, vol. 1, F. Enke, Stuttgart 1960.
65. Wacker, DT 1067010, 1951; BASF, DT 1105389, 1960.
66. Linde, US 2499009, 1947.
67. Union Carbide, US 2595620, 1948.
68. Dynamit Nobel, BE 856480, 1977.
69. Wacker, DT 623290, 1977.
70. Telecomunicações Brasileiras, BR 8006892, 1980 (J. W. C. Carvalho et al.).
71. A. C. F. de Arruda, L. C. Barbosa, *Congr. Ann. ABM, 35th*, vol. 3, Assoc. Brasileira Metais, Sao Paulo 1980, pp. 375-390.
72. V. F. Popenko et al., SU 833494, 1981.
73. General Electric, DE 3303903, 1983 (A. Ritzer, N. B. Shah, E. Daniel).
74. Toa Nenryo, JP 63170210, 1988 (H. Yamada, H. Ogawa, T. Hosokawa, M. Tachikawa).
75. Hüls, DE 3809784, 1989 (K. Ruff).
76. Elkem, DE 3938897, 1990 (K. Forwald, G. Schüßler, O. Soerli).
77. High Pure Silicon Co., JP 02145413, 1990 (M. Takaguchi, N. Moriika).
78. T. C. Hwang, H. H. Hsieh, *Energy Res. Abstr.* 24 (1984) no. 24.
79. K. X. Li, S. H. Peng, T. C. Ho, *AIChE Symp. Ser.* 84 (1988) 114-125.
80. Nippon Aerosil Co., DE 3230590, 1983 (T. Ito, H. Hori).
81. Mitsubishi Kakoki Kaisha, JP 02172811, 1990 (K. Akaike).
82. C. Zhang, CN 87100535, 1987.
83. Shin-Etsu Chemical Ind., JP 58161915, 1983.
84. Osaka Titanium Co., JP 56073617, 1981.
85. Mitsui Toatsu Chemicals, JP 63100014, 1988 (K. Inoe et al.).
86. General Electric, US 4390510, 1983 (A. Ritzer, B. Shah, D. E. Silva).
87. Mitsubishi Metal Corp., JP 57003711, 1982.
88. Council of Sci. and Ind. Research, IN 166734, 1990 (V. G. Neurgaonkar et al.).
89. Denki Kagaku Kogyo, JP 60081010, 1985.
90. Motorola, EP 133209, 1985 (W. M. Ingle, S. M. Pefley, H. S. N. Setty).
91. High Pure Silicon Co., JP 51118017, 1982.
92. Wacker, DE 3024319, 1982 (A. Göppinger et al.).
93. Nippon Steel Corp., JP 63112410, 1988 (M. Onozawa).
94. Shin-Etsu Chemical Ind., JP 57140309, 1982.
95. Mitsubishi Kakoki Kaisha, JP 63008207, 1988 (K. Akaike).
96. Nippon Steel Corp., JP 62021707, 1987 (M. Onozawa).
97. Mitsubishi Metal Corp., JP 62288109, 1987 (E. Kimura, K. Ogi, T. Kurashige).
98. Wacker, DE 3341340, 1985 (A. Schnegg, R. Rühländer).
99. J. Y. P. Mui, D. Seyferth, *Sci. Tech. Aerosp. Rep.* 19 (1981) no. 18.
100. J. Y. P. Mui, D. Seyferth, *Energy Res. Abstr.* 6 (1981) no. 6.
101. Rhône-Poulenc, EP 100266, 1984 (J. L. Lepage, G. Simon).
102. Osaka Titanium, JP 57140312, 1982.
103. Osaka Titanium, JP 57140311, 1982.
104. Osaka Titanium, JP 57129817, 1982.
105. Denki Kagaku Kogyo, JP 59035017, 1984.
106. Denki Kagaku Kogyo, JP 55045919, 1984.
107. W. M. Ingle, M. S. Pemey, *J. Electrochem. Soc.* 132 (1985) no. 5, 1236-1240.
108. Mitsui Toatsu, JP 01313317, 1989 (K. Inoue et al.).
109. Mitsui Toatsu, JP 63 095107, 1988 (K. Inoue et al.).
110. Mitsui Toatsu, JP 63095108, 1988 (K. Inoue et al.).
111. Mitsui Toatsu, JP 63100015, 1988 (K. Inoue et al.).
112. Mitsui Toatsu, JP 63095109, 1988 (K. Inoue et al.).
113. Mitsui Toatsu, JP 63100016, 1988 (K. Inoue et al.).
114. Mitsui Toatsu, JP 63095110, 1988 (K. Inoue et al.).
115. Osaka Titanium, JP 57156319, 1982.
116. Osaka Titanium, JP 58011042, 1983.
117. Z. Shen, J. Wang, CN 85107465, 1987.
118. Mitsui Toatsu, JP 63095111, 1988 (K. Inoue et al.).
119. Nippon Kokan, EP 255 877, 1988 (N. Yoneda et al.).
120. Nippon Kokan, JP 01100011, 1989 (K. Ozaki et al.).
121. Mitsubishi Metal Corp., JP 62256713, 1987 (E. Kimura, K. Ogi, T. Kurashige).
122. Idemitsu Kosan, JP 62270413, 1987 (N. Tanaka).
123. High Pure Silicon Co., JP 57156318, 1982.
124. V. F. Kochubei, *Otkrytiya, Izobret., Prom. Obraztoy, Tovarnye. Znaki* 1981, no. 45, 122.
125. Osaka Titanium, JP 62235205, 1987 (S. Morimoto).
126. Mitsui Toatsu, JP 63250484, 1988 (M. Murakami et al.).
127. Wacker, GB 906617, 1960.
128. Siemens & Halske, DT 955415, 1955.
129. Wacker, DT 1134973, 1958.
130. Union Carbide, DT 2507864, 1975.
131. Smiel, DT 2852598, 1979.
132. Bochkarev, SU 504699, 1976.
133. Dynamit Nobel, DT 1767667, 1976.
134. Wacker, DT 2546957, 1977.
135. Akademie der Wissenschaft, DL 135613, 1979.
136. Akademie der Wissenschaft, DL 136493, 1979.
137. A. A. Efremov, Y. D. Zel'venskii, *Tr. Mosk. Khim. Tekhnol. Inst. im. D. J. Mendeleeva* 96 (1977) 4-10.
138. Z. A. Elunika, V. J. Lobov, J. P. Polokhina, *Tsvetn. Met.* 1980, no. 3, 72-73.
139. Wacker, DT 2558183, 1977.
140. B. Köhler et al., DD 158322, 1983.
141. L. Y. Shvartsman et al., *Vysokochist. Veshchestva* 1989, no. 5, 136-140.
142. Dow Corning EP 107784, 1984 (R. S. Doornbos).
143. General Electric, DE 3423611, 1986 (W. D. Kray).
144. General Electric, JP 59097519, 1984.
145. General Electric, JP 59097518, 1984.
146. Motorola, US 440919, 1983 (R. D. Darnell, W. M. Ingle).
147. Union Carbide, DE 3709577, 1987 (W. C. Breneman, C. C. Yang, G. Henningsen).
148. Hüls Troisdorf, DE 3642285, 1988 (B. Falk, W. Grätz, K. Ruff).
149. Osaka Titanium, JA 73047500, 1973.
150. Mitsubishi Metal, JA 78097996, 1978.
151. Texas Instruments, US 3963838, 1976.
152. Pennish, US 4176166, 1979.
153. Mitsubishi Paper Mill, JA 77144959, 1978.
154. Wacker, BE 857689, 1978.
155. Harris-Intertype, US 3935040, 1976.
156. Siemens, DT 2535813, 1976.
157. Hitachi, JA 77044166, 1977.
158. Dow Corning, US 3961003, 1976.
159. Kuratomi, JA 74076721, 1974.
160. Kuratomi, JA 74059729, 1974.
161. Union Carbide, US 3900660, 1975.
162. Motorola, NL 75008684, 1976.
163. Siemens, DT 2508802, 1976.
164. Hitachi, JA 76027077, 1976.
165. Nippon Electric, JA 76086080, 1976.
166. Siemens, BE 841241, 1976.
167. Osaka Titanium, JP 02279512, 1990 (M. Kuramoto, T. Nakai).
168. Cabot, BE 850891, 1977.
169. IBM, US 3974003, 1976.
170. Siemens, DT 2519572, 1976.
171. UKR Agric. Acad. ZAP, SU 660968, 1980.
172. Hiratsuka Resin, JA 76033149, 1976.
173. Dow Corning, US 2571884, 1950.
174. BASF, FR 1009837, 1948.
175. Monsanto, GB 815276, 1950.
176. Th. Goldschmidt, DT 685728, 1936.
177. Union Carbide Belge, BE 562868, 1956.
177. Carborundum, US 1271713, 1918.
178. Stauffer Chem. Co., US 2739041, 1953.
179. Cabot, US 2843458, 1955.
180. E. Grunder, J. Elöd, *Z. Anorg. Allg. Chem.* 195 (1931) 269.
181. Konsort. für Elektrochem. Ind., GB 176811, 1922.
182. Degussa, DT 1079015, 1960.
183. Stauffer Chem. Co., GB 865939, 1959.
184. Stauffer Chem. Co., *Chem. Engng.* 69 (1962) 71.
185. L. V. Laine, SU 108316, 1957.
186. Kali-Chemie, DT 901412, 1954.
187. Horizons, GB 735617, 1953.
188. Union Carbide, EP 26860, 1979.
189. Mitsui Toatsu Chemicals, JP 59195519, 1984.
190. Mitsui Toatsu Chemicals, JP 59184720, 1984.
191. Wacker, DE 3503262, 1986 (R. Standigl, R. Griebhammer).
192. Int. Standard Electric, DAS 1074560, 1958.
193. Du Pont, US 2820698, 1954.
194. Bell Telephone Lab., US 2812235, 1955.
195. Westinghouse Electric, DT 1088473, 1957.
196. Western Electric, DT 1029811, 1956.
197. G. A. Wolff, US 2877097, 1958.
198. H. C. Theuerer, *J. Electrochem. Soc.* 107 (1960) 29.
199. G. G. Deryatykh, N. Kh. Agliulov, A. E. Wikolaev, E. M. Shcheplyagin, *Zh. Prikl. Khim. (Leningrad)* 53 (1980) no. 8, 1845-1848.
200. Denki Kagaku Kokyo, JP 02196014, 1990 (M. Fujimoto, M. Shinoyama, H. Matsumura).
201. Bell Telephone Lab., US 4282196, 1981 (T. Kometani, D. L. Wood).
202. General Electric, GB 309393, 1928.
203. Union chimique belge, GB 1042076, 1951.
204. Faustel Metallurgie, US 2665997, 2665998, 1950.
205. E. Fitzer, DE 178779, 1952.
206. Mitsui Toatsu Chemicals, JP 59162121, 1984.
207. Mitsui Toatsu Chemicals, JP 59232910, 1984.
208. Mitsui Toatsu Chemicals, JP 59207829, 1984.
209. Toa Gosei Chemical, DE 3623493, 1987 (M. Ito, T. Hattori, Y. Miwa).
210. Toa Gosei Chemical Industry, JP 63021211, 1988 (M. Ito, T. Hatsutori, Y. Miwa).
211. Mitsui Toatsu Chemicals, JP 61205614, 1986 (A. Hiai, K. Wakimura, T. Use).
212. Mitsui Toatsu Chemicals, JP 59207830, 1984.
213. Mitsubishi Metal Corp., JP 62070425, 1987 (H. Ikeda).
214. Mitsubishi Metal Corp., JP 63089414, 1988 (H. Ikeda, M. Tsunashima).
215. Mitsubishi Metal Corp., JP 62036014, 1987 (Y. Kuroda, K. Yamakawa).
216. Mitsubishi Metal Corp., JP 63091138, 1988 (H. Ikeda, M. Tsunashima, M. Sato).
217. Mitsubishi Metal Corp., EP 282037, 1988 (H. Ikeda, M. Tsunashima).
218. Mitsubishi Metal Corp., EP 264722, 1988 (H. Ikeda, M. Tsunashima, M. Sato).
219. Mitsubishi Metal Corp., JP 63210015, 1988 (H. Ikeda, M. Tsunashima, M. Sato).
220. Mitsubishi Metal Corp., JP 01192716, 1989 (K. Ogi, T. Kurashige, E. Kimura).
221. NEC Corp., JP 62296511, 1987 (A. Ishitani).
222. Dow Corning, FR 2486057, 1982 (J. H. Gaul, D. R. Weyenberg).
223. Toa Gosei Chemical, JP 61295372, 1986 (S. Motojima, T. Hattori, N. Ishikawa).
224. Toa Gosei Chemical, JP 63277599, 1988 (S. Motojima, T. Hattori, N. Ishikawa).
225. Mitsubishi Metal Corp., JP 01301507, 1989 (T. Hirai, H. Ikeda).
226. Mitsui Toatsu Chemicals, JP 62143839, 1987 (T. Iwao, K. Morii, Y. Tajima).
227. Mitsui Toatsu Chemicals, JP 62143840, 1987 (T. Iwao, K. Morii, Y. Tajima).
228. Mitsui Toatsu Chemicals, JP 61227914, 1986 (T. Iwao, K. Morii, Y. Tajima).
229. Wacker, DE 3518620, 1986 (R. Griebhammer, H. Herrmann, R. Standigl).
230. B. S. Suresh, D. K. Padma, *Polyhedron* 5 (1986) no. 10, 1579.

231. A. Kornick, M. Binnewies, *Z. Anorg. Anal. Chem.* **587** (1990) 157-166.
232. Dynamit Nobel, DE 3615509, 1987 (B. Falk, K. Ruff, K. Schrage).
233. P. Voss, Ph.D. thesis, Aachen 1961.
234. P. Voss, Dissertation, Aachen 1962.
235. H. Bloching, Dissertation, Freie Universität Berlin 1961.
236. Du Pont, US 2840588, 1956.
237. Kemira Oy, FI 82232, 1990 (V. P. Judin, A. Hayha, P. Koukkari).
238. Kemira Oy, US 5077027, 1991 (V. P. Judin, A. Hayha, P. Koukkari).
239. Semiconductor Energy Laboratory Co., JP 60054913, 1985.
240. M. Janai et al., *J. Appl. Phys.* **52** (1981) no. 5, 3622-3624.
241. H. Matsumura, H. Ihara, T. Uesugi, *J. Appl. Phys.* **57** (1985) no. 12, 5483-5485.
242. H. Matsumura, T. Uesugi, H. Ihara, *Mater. Res. Soc. Symp. Proc.*, **49** (1985) 175-180.
243. État français, FR 2620736, 1989 (Y. Pauleau, P. Lami, J. Pelletier).
244. Semiconductor Energy Laboratory Co., JP 60144940, 1985 (S. Yamazaki).
245. K. Zhang, Q. Yuan, *Huaxue Shijie* **23** (1982) no. 12, 353-354.
246. Schumacher, GB 2028289, 1980.
247. Ceres Corp., WP 8001489, 1980.
248. Schumacher, US 4084024, 1978.
249. Siemens, JA 77035605, 1977.
250. Western Electric, US 3932160, 1976.
251. Nippon Teleg. & Tel., JA 77088348, 1977.
252. Nippon Teleg. & Tel. and Furukawa Electric, JA 77104936, 1977.
253. Nippon Teleg. & Tel., JA 79127914, 1979.
254. Fuji Photo Film, JA 80167119, 1981.
255. Micron Technology Inc., US 5082524, 1992 (D. A. Cathey).
256. Schumacher, US 4318942, 1982 (L. M. Wörner, E. B. Moore).
257. Battelle Dev., US 3990953, 1976.
258. Exxon Res. & Eng., US 4192720, 1980.
259. Licentia Patentverwertung, DT 2929669, 1981.
260. Tokyo Shibaura Electric, JA 78140311, 1979.
261. UBE Industries GB 2020264, 1979.
262. Asahi Glass, JA 79134098, 1979.
263. Asahi Glass, JA 79160600, 1980.
264. Rosenthal, DT 2635167, 1977.
265. B. Armas, C. Combescure, G. Male, M. Morales, *Less-Common Met.* **67** (1979) no. 2, 449-453.
266. Toyota Cent. Res. & Dev., JA 75108183, 1977.
267. Hitachi, GB 19915, 1980.
268. Phillips Petroleum, BE 858462, 1978.
269. Asahi Glass, JP 62070219, 1987 (K. Sato et al.).
270. K. Zhang et al., *Huaxue Shijie* **5** (1983) no. 4, 251-253.
271. Dow Corning, EP 301678, 1989 (K. G. Sharp, J. J. D'Errico).
272. H. Schmäler E. Hengge, *J. Organomet. Chem.* **225** (1982) no. 1, 171-176.
273. M. Schmeißer, M. Schwarzmann, *Z. Naturforsch. B116* (1956) 278.
274. Kali-Chemie, DT 955414, 1954.
275. K. Friedrich, Thesis, RWTH-Aachen 1964.
276. Licentia Patentverwertung, DT 1045381, 1957.
277. Morrizons, GB 735617, 1953.
278. Kali-Chemie, DT 901412, 1954.
279. B. Rubin, G. H. Moates, J. R. Wenier, *J. Electrochem. Soc.* **104** (1957) 656.
280. Japan Telegram & Telephone, JA 13669, 1988.
281. Texas Instruments, US 4154870, 1979.
282. Int. Telephone & Telegraph, US 3961926, 1976.
283. H. Schäfer, *Chem.-Ztg.* **75** (1951) 48.
284. E. Zintl et al., *Z. Anorg. Chem.* **245** (1940) 1.
285. Goodrich, DT 1079608, 1956.
286. O. K. Botoinkin, SU 139657, 1960.
287. Fumio Hori, JP 59008613, 1984.
288. J. M. Huber, EP 176770, 1986 (D. E. Schramm).
289. L. Brewer, *Chem. Rev.* **52** (1953) 39.
290. W. Blitz, P. Ehrlich, *Naturwissenschaften* **26** (1938) 188.
291. G. Grube, H. Speidel, *Z. Elektrochem.* **53** (1949) 339.
292. H. v. Wartenberg, *Z. Elektrochem.* **53** (1949) 343.
293. H. Schäfer, R. Hörnle, *Z. Anorg. Allg. Chem.* **263** (1959) 261.
294. J. Berak, D. Grzeskowiak, *Zesz. Nauk. Politech. Slask. Vhem.* **88** (1979) 154-155.
295. Kernanord, RD 199058, 1980.
296. A. Marcks, H. Hausner, *Therm. Anal. Proc. Int. Conf. 6th 2* (1980) 223-228.
297. Hamatsu, NL 74006827, 1975.
298. Hitachi, DT 2365056, 1975.
299. Fujitsu, JA 79018689, 1979.
300. Stepanov, SU 423203, 1975.
301. Hoya Glass Works, DT 2443718, 1975.
302. Unitika, JA 74041469, 1975.
303. Richter, DL 120190, 1976.
304. Teijin Lens, JA 80110127, 1980.
305. BFG Glassgroup, BE 859428, 1978.
306. AS Phys. Metall. Inst., SU 609121, 1979.
307. Sony Corp., JA 79031721, 1979.
308. ITT Industries, FR 2362089, 1978.
309. Matsushita Elec. Ind., JA 79024866, 1979.
310. M. Schmitt, FR 2369103, 1978.
311. Matsushita Elec. Ind., JP 63276724, 1988 (K. Kimura et al.).
312. NHK Spring Co, JP 62071665, 1987 (T. Ebihara, T. Yokoo).
313. S. Yoshida, S. Misawa, *Denshi Gijutsu Sogo Kenkyusho Iho.*, **44** (1980) no. 1/2, 14-22.
314. United States Dept. of Energy, US 389802, 1983 (J. V. Milewski).
315. Lonza, DT 2531481, 1976.
316. Osaka Titanium, JA 74098807, 1975.
317. Suzuki, DT 2909104, 1979.
318. Toyota Chuv Kenkyusho, JA 76048799, 1976.
319. Lucas J. Industries, GB 1470171, 1977.
320. N. Azuma, T. Yamada, S. Kuwabare, *Yogyo Kyokai-shi* **86** (1978) no. 9, 418-424.
321. Ceraver, BE 858704, 1978.
322. Bludov, SU 438050, 1975.
323. Victor Co. of Japan, JA 75038200, 1976.
324. E. Zintl et al., *Z. Anorg. Allg. Chem.* **245** (1940) 1.
325. I.G. Farbemind., CH 215137, 1939.
326. Duisberg, US 2242497, 1939.
327. Kawasaki Steel, JA 78134794, 1979.

328. Toyota Motor Co., DE 3602647, 1986 (S. Abe, M. Ogawa).
329. Dow Corning, US 5051248, 1991 (G. N. Bokerman, J. P. Canady, C. S. Kuivida).
330. O. N. Carlson, F. A. Schmidt, *Proc. Vac. Metall. Conf. Spec. Met. Melting Process* **1985**, 129-136.
331. L. M. Ericsson, SE 450391, 1987 (T. S. Ganew, M. Jansson).
332. K. L. Day, B. Donn, *Science* **4365** (1978) 307-308.
333. B. S. Suresh, D. Krishnamurth Padma, *J. Chem. Soc. Dalton Trans.*, **1984**, no. 8, 1779-1780.
334. V. Belot et al., *J. Non-Cryst. Solids* **127** (1991) no. 2, 207-214.
335. E. Wilberg, W. Simmler, *Z. Anorg. Allg. Chem.* **283** (1956) 401.
336. Hitachi, JP 59074637, 1984.
337. Asahi Glass, JP 55058230, 1980.
338. Asahi Glass, JP 55145739, 1980.
339. Toppan Printing Co., JP 02122924, 1990 (M. Sekiguchi et al.).
340. Y. Wang, C. Jiang, *Bandaoti Xvebao*, **7** (1986) no. 6, 596-601.
341. N. A. Takasaki, E. Ikawa, Y. Kurogi, *J. Vac. Sci. Technol. B 4* (1986) no. 4, 806-811.
342. R. E. Stahlbush, W. E. Carlos, S. M. Prokes, *IEEE Trans. Nucl. Sci.*, **NS-34 6** (1987) part I, 1680-1685.
343. E. P. Bochkarev et al., *Vysokochist. Veshchestva* **1** (1989) 73-77.
344. Ei Shokusan K. K., JP 62183899, 1987 (F. Baba, K. Kozono, T. Hashiguchi, K. Maemura).
345. Kubota Ltd., JP 62250910, 1987 (Y. Okumura, Y. Okamoto, K. Yanai).
346. Unisearch Ltd., WO 8906222, 1989 (J. A. Bourdillon et al.).
347. I. N. Buyanovskii et al., *Trenie Iznas* **6** (1985) no. 1, 119-124.
348. A. Stock, F. Zeidler, *Ber. dtsh. chem. Ges.* **56** (1923) 986.
349. R. Müller, *Chem. Techn.* **2** (1950) 1.
350. G. H. Wagner, A. N. Pines, *Ind. Engng. Chem.* **44** (1952) 321.
351. R. Müller, R. Kohne, S. Sliwinski, *J. prakt. Chem.* **9** (1959) 71.
352. K. Larssow, *Ak. Kemi* **16** (1960) 215.
353. C. L. Frye, W. T. Collins, *J. Am. Chem. Soc.* **92** (1970) 5586.
354. H. Burgi, G. Calzaferri, *J. Chromatography* **507** (1990) 481.
355. P. A. Gaskar, *Inorg. Chem.* **30** (1991) 2707.
356. G. Calzaferri, *Nachr. Chem. Tech. Lab.* **40** (1992) 1106.
357. R. Gooden, J. W. Mitchell, *J. Electrochem. Soc.* **129** no. 7, 1619.
358. R. J. P. Corrir, *Organometallics* **10** (1991) 3574.
359. M. Laine, *Nature* **353** (1991) 642.
360. W. Humpel, V. Haasy, *Z. Anorg. Allg. Chem.* **23** (1900) 32.
361. M. Schmeißer, H. Müller, W. Burgermeister, *Angew. Chem.* **69** (1957) 781.
362. L. E. Gorsh, G. N. Dolenko, *ZV. Akad. Nauk. SSSR Neorg. Mater.* **15** (1979) no. 9, 1521-1523.
363. Kali-Chemie, DT 1008265, 1955, 1029810, 1957.
364. Mitsuhishi Electric, JA 77070498, 1977.
365. Toyota Motor Corp., JP 63079716, 1988 (S. Abe, O. Kazuaki, M. Ogawa).
366. N. V. Tolstoguzov, *Izv. Vyssh. Uchebn. Zaved., Chern. Metall.* **1991**, no. 4, 22-25.
367. Asahi Chemical Industry, JP 62252310, 1987 (Y. Yamada, N. Tamura, K. Makita).
368. Rockwell International Corp., US 4552740, 1985 (P. E. D. Morgan, E. A. Pugar).
369. Asahi Chemical Industry, JP 62252321, 1987 (Y. Yamada, N. Tamura, K. Makita).
370. R. Creus et al., *Mater. Sci. Eng. B B3* (1989) no. 1/2, 109-112.
371. J. H. Kennedy, Z. Zhang, *J. Electrochem. Soc.* **136** (1989) no. 9, 2441-2443.
372. B. T. Ahn, R. A. Huggins, *Mater. Res. Bull.* **25** (1990) no. 3, 381-389.
373. S. Sahami, S. W. Shea, J. H. Kennedy, *J. Electrochem. Soc.* **132** (1985) no. 4, 985-986.
374. J. H. Kennedy et al., *Solid State Ionics* **18-19** (1986) no. 1, 368-371.
375. Matsushita Electric Industrial Co., JP 04133209, 1992 (K. Yamamura, K. Takada, S. Kondo).
376. J. H. Kennedy, Y. Yang, *J. Electrochem. Soc.* **133** (1986) no. 11, 2437-2438.
377. A. A. Godovikov, R. G. Kuryaeva, *Fiz. Khim. Slekla* **9** (1983) no. 4, 502-509.
378. H. Moissan, A. Stock, *Ber. Dtsch. Chem. Ges.* **33** (1900) 2125.
379. Allis-Chalmers, US 3427131, 1969.
380. Texaco Dev., US 4038292, 1977.
381. Aktiebolag Kauthal, SW 201850, 1966.
382. R. Kiefer, F. Benesovsky: *Hartstoffe*, Springer Verlag, Wien 1963.
383. R. Kiefer: *Sondermetalle*, Springer Verlag, Wien 1971.
384. H. Walter in R. Durrer, G. Volkert (eds.): *Metallurgie der Ferrolegierungen*, Springer Verlag, Berlin 1972.
385. E. Schürmann, H. Litterscheid, P. Fünders, *Arch. Eisenhüttenwes.* **45** (1974) no. 6, 367-371.
386. *Handbuch für Eisenhüttenlaboratorium*, vol. 2, Verlag Stahleisen mbH, Düsseldorf.
387. "Probenahme", *Handbuch für das Eisenhüttenlaboratorium*, vol. 3, Verlag Stahleisen, Düsseldorf.
388. "Schiedsverfahren", *Handbuch für das Eisenhüttenlaboratorium*, vol. 4, Verlag Stahleisen, Düsseldorf.
389. B. Neuer, *Erzmetall* **42** (1989) no. 6, 239-243.
390. *Calcium Treatment Symposium Proceedings*, The Institute of Metals, London, 1988, Book 459.
391. K. C. Condie in K. H. Wedepohl (ed.): *Handbook of Geochemistry*, vol. II-2, Springer, Berlin 1970, Section 14.
392. R. Siever in [391].
393. H. Füchtbauer (ed.): *Sedimente und Sedimentgesteine*, 4th ed., Schweizerbarth, Stuttgart 1988.
394. *Ind. Miner. (London)* **236** (1987) 22-39.
395. O. W. Flörke et al., *Neues Jahrb. Mineral. Abh.* **163** (1991) 19-42.
396. M. J. Buerger, *Am. Mineral.* **39** (1954) 600-614.
397. C. Frondel: "Silica Minerals", *The System of Mineralogy*, 7th ed., vol. III, Wiley, New York 1962.
398. M. J. Mombourquette, J. A. Weil, *Can. J. Phys.* **63** (1985) 1282-1293.
399. R. D. Aines, G. R. Rossman, *JGR J. Geophys. Res.* **89** (1984) 4059-4071.

400. A. Nicolas, J. P. Poirier: *Crystalline Plasticity and Solid State Flow in Metamorphic Rocks*. Wiley, London 1976, Chap. 5.9.
401. O. W. Flörke, A. Nukui, *Neues Jahrb. Mineral. Abh.* **158** (1988) 175–182.
402. L. Pauling, *Am. Mineral.* **65** (1980) 321–323.
403. R. J. Hill, G. V. Gibbs, *Acta Crystallogr. Sect. B* **B35** (1979) 25–30.
404. M. O'Keefe, B. G. Hyde, *Acta Crystallogr. Sect. B* **B34** (1978) 27–32.
405. W. H. Baur, *Acta Crystallogr. Sect. B* **B36** (1980) 2198–2202.
406. W. A. Harrison: *Electronic Structure and the Properties of Solids*, Fleeman, San Francisco 1980 pp. 257–288.
407. J. R. G. Da Silva, D. G. Pinatti, C. E. Anderson, M. L. Rudee, *Philos. Mag.* **31** (1975) 731–737.
408. K. Langer, O. W. Flörke, *Fortschr. Mineral.* **52** (1974) 17–51.
409. K. D. Aines, G. R. Rossman, *JGR J. Geophys. Res.* **89** (1984) 4059–4071.
410. L. Levien, C. T. Prewitt, *Am. Mineral.* **66** (1981) 324–333.
411. H. Grätsch, O. W. Flörke, *Z. Kristallogr.* **195** (1991) 31–48.
412. G. V. Gibbs, C. T. Prewitt, K. J. Baldwin, *Z. Kristallogr.* **145** (1977) 108–123.
413. E. M. Lewien, C. R. Robbins, H. F. McMurdie in M. K. Reser (ed.): *Phase Diagrams for Ceramists*, suppl., Amer. Ceram. Soc., Columbus 1969.
414. C. B. Sclar, A. P. Young, L. C. Carrison, C. M. Schwartz, *JGR J. Geophys. Res.* **67** (1962) 4049–4054.
415. M. A. Spackmann, R. J. Hill, G. V. Gibbs, *Phys. Chem. Miner.* **14** (1987) 139–150.
416. R. Wörner, O. F. Schirmer, *Phys. Rev.* **B34** (1986) 1381–1383.
417. J. D. H. Donnay, Y. Le Page, *Acta Crystallogr. Sect. A* **A34** (1978) 548–594.
418. K. Kihara, *Eur. J. Mineral.* **2** (1990) 63–77.
419. R. F. Newnham: *Structure-Property Relations*, Springer, Berlin 1975.
420. S. Haussühl: *Kristallphysik*, Verlag Chemie, Weinheim 1983, Chap. 11.4.
421. H. Grimm, B. Dorner, *J. Phys. Chem. Solids* **36** (1975) 407–413.
422. H. Salmang, H. Scholze: *Keramik*, 6th ed., vol. 1, Springer, Berlin 1982.
423. T. Barry, P. McNamara, W. Moore, *J. Chem. Phys.* **42** (1965) 2599–2606.
424. V. Rumyantsev, A. Novozhilov, *Sov. Phys. Crystallogr. (Engl. Transl.)* **25** (1980) 75–78.
425. R. Pankrath, *Phys. Chem. Miner.* **17** (1991) 681–689.
426. G. C. Kennedy, *Econ. Geol.* **45** (1950) 629–653.
427. G. M. Anderson, C. H. Burnham, *Am. J. Sci.* **263** (1965) 495–511.
428. G. M. Morey, R. O. Fournier, J. J. Rowe, *Geochim. Cosmochim. Acta* **26** (1962) 1029–1043.
429. S. H. Chan, *Geothermics* **18** (1989) 49–56.
430. P. Cordier, B. Boulogne, J.-C. Doukhan, *Bull. Mineral.* **111** (1988) 113–137.
431. J. Mullis in M. Frey (ed.): *Low Temperature Metamorphism*, Blachie, Glasgow 1987, Chap. 5.
432. H. Frischat, *Ber. Dtsch. Keram. Ges.* **47** (1970) 238–243, 313–316.
433. N. G. Stenina, L. S. Bazarov, M. Y. Sherbakova, R. J. Mashkortsev, *Phys. Chem. Miner.* **10** (1984) 180–186.
434. O. W. Flörke, *Krist. Teeh.* **7** (1972) 159–166.
435. O. W. Flörke, U. Flörke, U. Giese, *Neues Jahrb. Mineral. Abh.* **149** (1984) 325–336.
436. G. Miehe, H. Grätsch, *Eur. J. Mineral.* **4** (1992) 693–706; **182** (1988) 183–184.
437. A. F. Wright, A. J. Leadbetter, *Philos. Mag.* **31** (1975) 1391–1401.
438. O. W. Flörke, H. Schneider, *cfi/Ber. Dtsch. Keram. Ges.* **63** (1986) 368–372.
439. O. W. Flörke, *Glastechn. Ber.* **32** (1959) 1–9.
440. U. Seifert-Krauß, H. Schneider, *Ceramics Intern.* **10** (1984) 135–142.
441. H. Schneider, *Neues Jahrb. Mineral. Monatsh.* **1986**, 433–444.
442. O. W. Flörke, K. Langer, *Contrib. Mineral. Petrol.* **36** (1972) 221–230.
443. H. Schneider, O. W. Flörke, *Neues Jahrb. Mineral. Abh.* **145** (1982) 280–290.
444. H. Schneider, O. W. Flörke, *Z. Kristallogr.* **175** (1986) 165–176.
445. A. Nukui, O. W. Flörke, *Am. Mineral.* **72** (1987) 167–176.
446. O. W. Flörke, *Ber. Dtsch. Keram. Ges.* **34** (1957) 343–353.
447. A. C. D. Chaklader, *J. Amer. Ceram. Soc.* **46** (1963) 66–71, 192–193.
448. U. Steinicke et al., *Cryst. Res. Technol.* **22** (1987) 1255–1261.
449. M. Grassellini Troysi, P. Orlandi, *Atti. Soc. Tosc. Sci. Nat., Mem.* **A79** (1972) 245–250.
450. H. Gies, H. Gerke, F. Liebau, *Neues Jahrb. Mineral. Monatsh.* **3** (1982) 119–124.
451. B. Martin, K. Röller, *Neues Jahrb. Mineral. Monatsh.* **1990**, 462–466.
452. J. Shropshire, P. P. Keat, P. A. Vaughan, *Z. Kristallogr.* **112** (1959) 400–413.
453. F. Liebau, *Am. Mineral.* **63** (1978) 918–923.
454. B. Baumgartner, G. Müller, *Eur. J. Mineral.* **2** (1990) 155–162.
455. Al. Weiß, Ar. Weiß, *Z. Anorg. Allg. Chem.* **276** (1954) 95–112.
456. O. W. Flörke, J. B. Jones, U. Köster, E. Robarick, *Acta Crystallogr.* **A46** (1990) Suppl. C-247.
457. P. J. Darragh, A.-J. Gaskin, J. V. Sanders, *Sci. Am.* **234** (1976) 84–95.
458. H. Grätsch, A. Mosset, H. Gies, *J. Noncryst. Solids* **119** (1990) 173–180.
459. F. J. Pettijohn: *Sedimentary Rocks*, 3rd ed., Harper & Row, New York 1975, pp. 195ff., 300ff., 392ff.
460. H. Williams, F. J. Turner, C. M. Gilbert: *Petrography*, 2nd ed., Freeman, San Francisco 1982.
461. A. Peschel: *Natursteine*, 2nd ed., Dtsch. Verlag Grundstoffind., Leipzig 1983, pp. 77–80, 243–251, 274–275.
462. S. J. Lefond (ed.): *Industrial Minerals and Rocks (Nonmetallics other than Fuels)*, 4th ed., Amer. Inst. Mining Metallurg. Petrol. Eng. AIME, New York 1975.
463. P. Harben, *Ind. Miner. (London)* **184** (1983) 28–29, 32.

464. O. Braitsch, *Heidelb. Beitr. Mineral. Petrogr.* **5** (1957) 331–372.
465. O. W. Flörke, B. Köhler-Herbertz, K. Langer, I. Tönges, *Contrib. Mineral. Petrol.* **80** (1982) 324–333.
466. M. Smith, *Ind. Min. (London)* **203** (1984) 19–25.
467. K.-T. Wilke: *Kristallzüchtung*, H. Deutsch, Thun 1988, p. 1027–1058.
468. E. D. Kolb et al., *J. Crystal Growth* **36** (1976) 93–100.
469. V. S. Balitsky, *J. Crystal Growth* **41** (1977) 100–102.
470. C. G. Kennedy, W. L. Knight, W. T. Holser, *Am. J. Sci.* **256** (1958) 590–595.
471. W. T. Holser, C. G. Kennedy, *Am. J. Sci.* **257** (1959) 71–77.
472. C. G. Kennedy, *Econ. Geol.* **45** (1950) 629–653.
473. R. A. Laudise, E. D. Kolb, *Endeavour* **28** (1969) 114–117.
474. N. B. Hannay (ed.): “Change of State”, *Treatise on Solid State Chemistry*, vol. 5, Plenum Press, New York 1975.
475. J. Hoffmann, Frank & Schulte GmbH, Essen, personal communication.
476. V. A. Kuznetsov, A. N. Lobachev, *Sov. Phys. Crystallogr.* **17** (1973) 775–803.
477. G. Lehmann, H. U. Bambauer, *Angew. Chemie* **85** (1973) 281–289.
478. K. Nassau, B. Prescott, *Mineral. Mag.* **41** (1977) 301–312.
479. J. A. Weil, *Phys. Chem. Mineral.* **10** (1984) 149–165.
480. A. C. McLaren, C. F. Osborne, L. A. Saunders, *Phys. Stat. Solidi* **4** (1971) 235–247.
481. A. C. McLaren, R. F. Cook, S. T. Hyde, R. C. Tobin, *Phys. Chem. Miner.* **9** (1983) 79–94.
482. M. S. Paterson, *Bull. Mineral.* **105** (1982) 20–29.
483. J. Flicstein, M. Schieber, *J. Cryst. Growth* **24/25** (1974) 603–609.
484. P. P. Phakey, *Phys. Stat. Solidi* **34** (1969) 105–119.
485. A. C. McLaren, P. P. Phakey, *Phys. Stat. Solidi* **31** (1969) 723–737.
486. D. R. Hale in S. J. Lefond (ed.) in [462].
487. D. M. Dodd, D. B. Frazer, *J. Phys. Chem. Solids* **26** (1965) 673–686.
488. W. G. Cady: *Piezoelectricity*, Dover Publ., New York 1964.
489. P. Profos (ed.): *Handbuch der industriellen Meßtechnik*, 4th ed., Vulkan-Verlag, Essen 1987.
490. G. Lindemann, personal communication.
491. H. Salmang, H. Scholze: *Keramik*, 6th ed., vol. 2, Springer, Berlin 1983.
492. M. K. Reser (ed.): *Phase Diagrams for Ceramists*, 2nd ed., Amer. Ceram. Soc., Columbus, OH, 1964, No. 313, 314 and 1975 Suppl., No. 4373.
493. J. Mackenzie, *Trans. Br. Ceram. Soc.* **51** (1952) 136–171.
494. H. Schneider, K. Wohlleben, A. Majdic, *Mineral. Mag.* **43** (1980) 879–883.
495. H. Schneider, A. Majdic, *Neues Jahrb. Mineral. Monatsh.* (1984) 559–568.
496. O. W. Flörke, *Ber. Dtsch. Keram. Ges.* **34** (1957) 343–353.
497. I. Patzak, *Tonind. Ztg.* **96** (1972) 291–297.
498. A. Majdic, *Keram. Ztg.* **34** (1982) 89–92.
499. H. J. Koschlig in L. J. Trostel Jr. (ed.): *UNITECR Proc.*, vol. 1, Amer. Ceram. Soc., Columbus, OH, 1989, pp. 244–283.
500. P. Das, N. R. Sircar, R. Choudhury, *InterCeram.* **38** (1989) 23–24.
501. F. Press, R. Siever: *Earth*, 4th ed., Freeman, San Francisco 1986.
502. B. J. Skinner, S. C. Parker: *Physical Geology*, Wiley-Interscience, New York 1987.
503. L. Jung: *High Purity Natural Quartz*, part I: “High Purity Natural Quartz for Industrial Uses”; Part II: “High Purity Natural Quartz Markets for Suppliers and Users”, Quartz Technology Inc., Liberty Corner, NJ, 1992.
504. R. Weiß: *Formgrundstoffe*, Gießerei-Verlag, Düsseldorf 1984.
505. J. Griffith, *Ind. Miner. (London)* **235** (1987) 25–43.
506. H. Füchtbauer (ed.): *Sedimente und Sedimentgesteine*, 4th ed., Schweizerbarth, Stuttgart 1988.
507. E. Roedder in H. L. Barnes (ed.): *Geochemistry of Hydrothermal Ore Deposits*, 2nd ed., J. Wiley & Sons, New York 1979.
508. J. Mullis in M. Frey (ed.): *Low Temperature Metamorphism*, Blackie, Glasgow 1987, pp. 162–199.
509. C. Müller (ed.): *Databook für Keramik-Glas-Baustoff-Produktion*, 2nd ed., Sprechsaal-Verlag, Coburg 1975.
510. R. Weiß, *Ber. Dtsch. Keram. Ges.* **55** (1978) 82–91.
511. *Ind. Miner. (London)* **197** (1984) 19–37, 39–45.
512. J. T. Nash, T. Theodore, *Econ. Geol.* **66** (1971) 385–399.
513. C. Frondel: “Silica Minerals”, *The System of Mineralogy*, 7th ed., vol. 3, J. Wiley & Sons, New York 1962.
514. H. Grätsch, O. W. Flörke, G. Miehe, *Phys. Chem. Miner.* **14** (1987) 249–257.
515. B. Sawyer, US 3837826, 1974.
516. L. Jung, US 4882043, 1989.
517. G. Lindemann, private communication.
518. *Ullmann*, 4th ed., **21**, 444–450.
519. R. Weiß, *Erzmetall* **27** (1974) 169–177; **31** (1978) 450–457.
520. S. N. Groudev, V. J. Groudeva, *Ind. Miner. (London)* **222** (1986) 81–84.
521. P. Harben, *Ind. Miner. (London)* **184** (1983) 28–29, 32.
522. H. Scholze (ed.): “Keramische Werkstoffe”, *Keramik*, part 2, 6th ed., Springer Verlag, Berlin 1983.
523. B. M. Coope, *Ind. Miner. (London)* **298** (1989) 43–55.
524. A. Peschel: *Natursteine*, 2nd ed., Dtsch. Verlag Grundstoffindustrie, Leipzig 1983.
525. H. Gundlach: *Dampfgehärtete Baustoffe*, Bauverlag, Wiesbaden 1973.
526. H. Inslay, V. D. Fréchette: *Microscopy of Ceramics and Cements*, Academic Press, New York 1955.
527. R. Weiß, *Glastechn. Ber.* **49** (1976) 12–25.
528. J. Lange: *Rohstoffe der Glasindustrie*, Dtsch. Verlag Grundstoffind., Leipzig 1980.
529. A. G. Pincus, D. H. Davies (eds.): “Major Ingredients”, *Raw Materials in the Glass Industry*, part 1, Ashlee Publ., New York 1983.
530. H. Petzold, H. Pöschmann: *Email und Emailtechnik*, Springer, Berlin 1987.

531. N. Severinghaus, Jr. in S. J. Lerond (ed.): *Ind. Miner. Rocks* 1975, 235-249.
532. Roskill Inform. Serv. Ltd.: *The Economics of Diatomite*, 2nd ed., London 1981, p. 73.
533. L. Pettifer, *Ind. Miner. (London)* 175 (1982) 47-69.
534. L. Benda, H. Brandes, *Geol. Jahrb. Reihe A* 21 (1974) 3-85.
535. L. Benda, *Schriften. GDMB* 38 (1981) 134-140.
536. W. B. Clark, *Calif. Geol.* 31 (1978) 3-9.
537. L. Benda, B. Mattiat, *Geol. Jahrb. Reihe D* 22 (1977) 3-107.
538. F. L. Kadey, Jr. in S. J. Lerond (ed.): *Ind. Miner. Rocks* 1975, 605-635.
539. *Ind. Miner. (London)* 1987, May, 22-39.
540. Ullmann, 4th ed., 21, 452-456.
541. Militeuropäische Brautechnische Analysenkommission (MEBAK): *Methodensammlung*, Freising 1982, III, pp. 651-659.
542. Supplier: VEL Geldenaaksebaan 464, B-3030 Leuven (Heverlee), Belgium.
543. S. Ward: "Liquid Filtration Theory", in M. J. Mattonson, C. Orr (eds.): *Filtration, Principles and Practices*, New York-Basel 1987.
544. J. Kierer: "Kieselgurfiltration", *Brauwelt* 40 (1990) 1730-1749.
545. E. Krüger, N. Wagner, B. Lindemann: "Einflußgrößen bei der Bierfiltration", *Brauwelt* 50 (1989) 2434-2444.
546. International Agency for Research on Cancer (IARC): "Silica and Some Silicates", *Carcinogenic Risk of Chemicals to Humans*, no. 42, Lyon 1987.
547. International Diatomite Producers Association (IDPA): *Silica Facts Questions and Answers; Health and Safety Aspects of Diatomaceous Earth, The Nature and Safe Handling of Diatomaceous Earth*, San Francisco 1989.
548. *Br. J. Ind. Med.* 46 (1989) 289-291.
549. O. Walton: "Filter Media", *The Brewer* 64 (1978) 261-265.
550. F. Kainer, *Kieselgur*, 2nd ed., Enke, Stuttgart 1951, pp. 39-43.
551. D. H. Everett: "Definition Terminology and Symbols in Colloid and Surface Chemistry", *Symbols and Terminology for Physicochemical Quantities and Units*, Appendix II, part 1, International Union of Pure and Applied Chemistry, Butterworths, London 1971.
552. R. K. Iler: *The Chemistry of Silica*, J. Wiley & Sons, New York 1979, p. 174.
553. T. Graham, *Justus Liebigs Ann. Chem.* 121 (1862) 36.
554. R. Griebbach, *Chem. Ztg.* 57 (1933) 253.
555. P. G. Bird, US 2244325, 1945.
556. M. F. Bechtold, O. E. Snyder, US 2574902, 1951.
557. "Silicates and Silicas Report", *Chemical Economics Handbook*, SRI International, Menlo Park 1990.
558. *Opportunities in Specialty Silicas*, Kline & Co., Fairfield, NJ, 1992.
559. E. S. Gould: *Inorganic Reactions & Structures*, Henry Holt & Company, New York 1957.
560. G. J. Fine, *J. Chem. Ed.* 68 (1991) 765.
561. W. D. Kingery, H. K. Bowen, D. R. Uhlmann: *Introduction to Ceramics*, 2nd ed., J. Wiley & Sons, New York 1976.
562. V. Hofman, K. Endell, D. Wilm, *Angew. Chem.* 30 (1934) 539-558.
563. V. Khavryutchenko et al.: "Abstracts of Papers", in R. K. Iler (ed.): *Memorial Symposium on the Colloid Chemistry of Silica*, Washington, DC, 1990, Paper no. 100.
564. A. P. Legrand et al., *Adv. Colloid Interface Sci.* 33 (1990) 91-330.
565. R. S. McDonald, *J. Phys. Chem.* 62 (1958) 1168.
566. M. L. Hair: *Infrared Spectroscopy in Surface Chemistry*, Marcel Dekker, New York 1967, p. 82.
567. J. B. Peri, A. L. Hensley, Jr., *J. Phys. Chem.* 72 (1968) no. 8, 2926-2933.
568. G. E. Maciel, D. W. Sindorf, *J. Am. Chem. Soc.* 102 (1980) 7606-7607.
569. K. D. Unger: "Porous Silica", *J. Chromatogr. Libr.* 16 (1979).
570. M. L. Hair in A. T. Bell, M. L. Hair (eds.): "Vibrational Spectroscopies for Adsorbed Species", *ACS Symp. Ser.* 137 (1980).
571. L. T. Zhuravlev: "Abstracts of Papers", in R. K. Iler (ed.): *Memorial Symposium on the Colloid Chemistry of Silica*, Washington, DC, 1990, Paper no. 93.
572. R. K. Iler in [552], p. 410.
573. Du Pont Company, Nalco Inc., and Nissan Chemicals, based on product information sheets (not specifications).
574. Cabot Corp., and Nissan Inc. and Nissan Chemicals, based on product information sheets (not specifications).
575. Nalco Inc., Nissan Chemicals, and Nippon Seahostar, based on product information sheets (not specifications).
576. R. K. Iler in [552], p. 325.
577. R. K. Iler in [552].
578. B. V. Derjaguin: *Theory of Stability of Colloids and Thin Films*, Consultants Bureau, New York 1989.
579. G. W. Sears, R. K. Iler, private communication.
580. D. H. Napper: *Polymer Stabilization of Colloidal Dispersions*, Academic Press, London 1983.
581. R. K. Iler in [552], p. 364.
582. R. K. Iler in [552], p. 396.
583. R. K. Iler in [552], p. 367.
584. R. K. Iler in [552], p. 366.
585. R. K. Iler, *J. Phys. Chem.* 56 (1952) 680.
586. E. Matijevic et al., *J. Phys. Chem.* 73 (1969) 564.
587. R. K. Iler in [552], p. 409.
588. G. B. Alexander, A. H. Bolt, US 3007878, 1961.
589. J. T. Overbeek, private communication, 1955, unpublished.
590. E. Matijevic, *J. Colloid Sci.* 19 (1964) 333.
591. W. Stober, A. Fink, *J. Colloid Interface Sci.* 26 (1968) 62.
592. R. K. Iler in [552], p. 331.
593. A. B. Alexander, A. H. Bolt, US 3007878.
594. R. C. Atkins, US 3012973, 1961.
595. R. K. Iler, F. J. Wolter, US 2631136, 1953.
596. M. Mindick, L. E. Reven, US 3468813, 1969.
597. L. A. Dimberger, US 2703314, 1955.
598. J. Klöpfer, DT 762723, 830786, 1942.
599. C. J. Brinker, G. W. Scherer: *Sol-Gel Science*, Academic Press, San Diego 1990.
600. C. G. Tan et al., *J. Colloid Interface Sci.* 118 (1987) 290-293.

601. J. Wolf, private communication.
602. R. K. Iler, US 3668088, 1972.
603. H. E. Bergna, US 4410405, 1983.
604. G. B. Alexander, US 2750345, 1956.
605. H. E. Bergna, F. A. Simko, Jr., US 3301635, 1967.
606. H. H. Mandelbrot in D. Avnir (ed.): *A Fractional Approach to Heterogeneous Chemistry*, J. Wiley & Sons, New York 1989.
607. S. Brumauer, P. H. Emmett, E. Teller, *J. Am. Chem. Soc.* 60 (1938) 309.
608. G. W. Sears, *Anal. Chem.* 28 (1956) 1981.
609. R. K. Iler in [552], p. 354.
610. T. Allen, R. Davies in R. K. Iler (ed.): "Abstracts of Papers", *Memorial Symposium on the Colloid Chemistry of Silica*, Washington, DC, 1990, Paper no. 37.
611. J. Kirkland in H. E. Bergna (ed.): "Colloid Chemistry of Silica", *Adv. Chem. Ser.* 234, in press.
612. P. F. Collins, US 2380945, 1945.
613. P. G. Batelson, CA 1154564, 1983.
614. K. Anderson et al., *Nord. Pulp Pap. Res. J.* (1986).
615. K. A. Johnson, US 4643801, 1987.
616. S. C. Sofia et al., US 4795531, 1989.
617. J. D. Rushmere, US 4798653, 1989.
618. R. K. Iler, US 2597871, 1947.
619. R. K. Iler, US 2726961, 1955.
620. I. V. Wilson, US 2643048, 1953.
621. R. J. Walsh, A. H. Herzog, US 3170273, 1965.
622. G. W. Sears, US 3922393, 1975.
623. J. L. Callahan, US 2974110, 1961.
624. J. L. Callahan et al., US 3322847, 1967.
625. H. Ferch in H. Bergna (ed.): "The Colloid Chemistry of Silica", *Adv. Chem. Ser.* 234, in press.
626. T. Graham, *Philos. Trans. R. Soc. London* 252 (1861) 204.
627. J. G. Vail: "Soluble Silicates", *ACS Monograph Series*, vol. 2, Reinhold, New York 1952, p. 549.
628. Ullmann, 4th ed., 21, pp. 458-462.
629. W. A. Patrick, US 1297724, 1918.
630. R. K. Iler: *The Chemistry of Silica*, J. Wiley & Sons New York 1979.
631. C. J. Brinker, G. W. Scherer: *Sol-Gel Science*, Academic Press, San Diego 1990.
632. Wijnen et al., *J. Colloid Interface Sci.* 145 (1991) 17.
633. M. E. Winyall in B. E. Leach (ed.): *Applied Industrial Catalysis*, vol. 3. Academic Press, Orlando 1984, p. 43.
634. S. S. Kistler, *J. Phys. Chem.* 36 (1932) 52.
635. P. H. Tervari, A. J. Hunt, US 4610863, 1986.
636. BASF, US 4667417, 1987 (F. Graser, A. Stange).
637. L. C. Klein (ed.): *Sol-Gel Technology for Thin Films, Fibers, Preforms, Electronics, and Specialty Shapes*, Naves, Park Ridge, New Jersey, 1988.
638. M. B. Kenny, K. S. W. Sing in H. Bergna (ed.): "The Colloid Chemistry of Silica", *Adv. Chem. Ser.* 234, in press.
639. S. Brunauer, P. H. Emmett, E. Teller, *J. Am. Chem. Soc.* 60 (1938) 309.
640. R. W. Cranston, F. A. Inkley, *Adv. Catal.* 9 (1957) 143.
641. K. Sing in G. Parfitt, K. Sing (eds.): *Characterization of Powder Surfaces*, Academic Press, New York 1976, p. 34.
642. R. L. White, A. Nair, *Appl. Spectrosc.* 44 (1990) 69.
643. P. Wijnen, T. Beelen, R. van Santen in H. Bergna (ed.): "The Colloid Chemistry of Silica", *Adv. Chem. Ser.* 234, in press.
644. V. K. Markov, N. A. Nagornaya, *J. Applied Chem. (USSR)* 10 (1937) 853.
645. E. Heimann, US 2316241, 1938.
646. Davison Chemical, US 2625492, 1949 (L. O. Young).
647. W. R. Grace & Co., US 2856268, 1954 (L. O. Young).
648. Houdry, US 2232727 (A. G. Peterkin, H. A. Shabaker).
649. Mizusawa Ind. Chem., DE 1442778, 1963 (T. Kuwata, Y. Sugahara, T. Nakazawa).
650. Asahi Chem. Ind., JP 48013834, 1966 (K. Takizawa, Y. Ohba).
651. BASF, DE 2103243, 1979 (G. Merz, H. Gehrig, W. Chorbacher).
652. Socony-Vacuum Oil Comp., US 2385217, 1945 (M. M. Marisic).
653. Kali-Chemie, DE 1567617, 1970 (J. Dultz).
654. J. F. White, I. V. Wilson, *Ind. Eng. Chem.* 33 (1941) 1169.
655. Fuji-Davison, Art-Sorb®-Technical Information (in English), 4.11.27 Meieki, Nagoya-shi, Japan 450.
656. R. S. McDonald, *J. Am. Chem. Soc.* 79 (1957) 850.
657. Crosfield, US 3617301, 1968 (D. Barby, J. P. Quinn).
658. W. R. Grace & Co., US 4629588, 1984 (W. A. Welsh, Y. O. Parent).
659. A. Bertod, *J. Chromatogr.* 549 (1991) 1.
660. J. Freng, GB 203248, 1922.
661. Lever Bros., US 3538230, 1966 (M. Pader, W. Wiesner).
662. W. R. Grace & Co., US 4303641, 1978 (R. B. DeWolf, R. Glemza).
663. J. M. Huber, US 4340583, 1977 (S. K. Wason).
664. M. Pader: *Oral Hygiene Products and Practice*, Marcel Dekker, New York 1988.
665. J. S. Magee, J. J. Blazek in J. A. Rabo (ed.): "Zeolite Chemistry and Catalysis", *ACS Monogr.* 1976, no. 171, 615.
666. Phillips Petroleum, US 3378540, 1964 (D. R. Witt).
667. F. Karol et al., *J. Polym. Sci., Polym. Chem. Ed.* 10 (1972) 2621.
668. Exxon Chemical, US 4701432, 1986 (H. C. Welborn).
669. H. Ferch, *Chem. Ing. Tech.* 48 (1976) 922.
670. B. M. Coope, *Ind. Miner. (London)* 1989, no. 3, 43.
671. D. D. Dunnon (ed.): *Health Effects of Synthetic Silica Particulates*, ASTM Special Technical Publication, no. 732, Philadelphia 1981.
672. Y. Takizawa et al., *Acta Med. Biol. (Niigata)* 36 (1988) 27.
673. Degussa, DE 762723, 1942 (H. Klöpfer).
674. S. Brunauer, P. H. Emmett, E. Teller, *J. Am. Chem. Soc.* 60 (1938) 309.
675. H. Ferch, K. Seibold, *Farbe Lack* 90 (1984) 88.
676. Degussa, *Schriftenreihe Pigmente*, Paper no. 11, Frankfurt 1992.
677. M. Schmücker, "Untersuchungen an nichtkristallinen technischen Kieselsäuren unter besonderer Berücksichtigung des thermischen Transforma-

- tions-verhaltens", Diplomarbeit, Ruhr-Universität, Bochum 1988.
678. H. Wistuba, "Die Silanolgruppen der Siliciumdioxidoberfläche und ihre chemischen Reaktionen", Dissertation, Universität Heidelberg 1967.
679. J. Mathias, G. Wannemacher, *J. Colloid Interface Sci.* **125** (1988) 61.
680. D. Kerner, W. Leiner, *Colloid Polym. Sci.* **253** (1975) 960.
681. H. Ferch, *Seifen Öle Fette Wachse* **101** (1975) 17, 51.
682. B. A. Morrow, A. J. McFarlan, *J. Non Cryst. Solids* **120** (1990) 61.
683. B. A. Morrow, A. J. McFarlan, *Langmuir* **7** (1991) 1695.
684. K. Yoshinaga et al., *Chem. Lett.* **1991**, 1129.
685. C. P. Tripp, M. L. Hair, *Langmuir* **7** (1991) 923.
686. G. Hellwig, *Farbe Lack* **81** (1975) no. 8, 705.
687. A. Meffert, A. Langenfeld, *Fresenius Z. Anal. Chem.* **249** (1979) 231.
688. H.-P. Böhm, M. Schneider, *Z. Anorg. Allg. Chem.* **301** (1959) 326.
689. H.-P. Böhm, *Kolloid Z. Z. Polym.* **227** (1968) 17.
690. H.-P. Böhm, *Angew. Chem.* **78** (1966) no. 12, 617.
691. Degussa, DE 1163784, 1962 (H. Brünner, J. Diether, D. Schutte).
692. Degussa, DE 3211431, 1982 (H. Klebe et al.).
693. Ivoclar, DE 3632215, 1986 (V. M. Rheinberger, T. Büchl).
694. Blendax, WO 8503220, 1985 (W. Kuhlmann).
695. Kulzer, DE 2405578, 1974 (A. Groß, R. Schäfer).
696. Canon, EP 369443, 1989 (Y. Sato, T. Kukimoto).
697. Nippon Aerosil Corp., JP 58185405, 1983 (N. Furuya, T. Morii).
698. Canon, EP 216295, 1986 (K. Tanaka et al.).
699. V. M. Litvinov et al., *Acta Polym.* **39** (1988) no. 5, 244.
700. G. Berrod, A. Vidal, E. Papirer, J. B. Donnet, *J. Appl. Polym. Sci.* **23** (1979) 2679; **26** (1981) 833 1015.
701. P. Vondracek, M. Schätz, *J. Appl. Polym. Sci.* **21** (1977) 3211.
702. L. A. Peters, J. C. Vivic, D. E. Cain, *GAK Gummi Asbest Kunstst.* **44** (1991) no. 2, 69.
703. H. Ferch, A. Reiser, R. Bode, *Kautsch. Gummi Kunstst.* **39** (1986) 1084.
704. Degussa, *Schriftenreihe Pigmente*, Paper no. 23, Frankfurt 1986.
705. Degussa, *Schriftenreihe Pigmente*, Paper no. 68, Frankfurt 1985.
706. Degussa, *Schriftenreihe Pigmente*, Paper no. 18, Frankfurt 1989.
707. K. Borho et al., *Chem. Ing. Tech.* **63** (1991) no. 8, 792.
708. H. Rumpf, *Chem. Ing. Tech.* **46** (1974) no. 1, 1.
709. R. Tawashi, *Pharm. Ind.* **25** (1963) 64.
710. H. Ferch, H. Gerofke, H. Itzel, H. Klebe, *Arbeitsmedizin Sozialmedizin Präventivmedizin* **22** (1987) 6, 23.
711. F. Leuschner, unpublished results.
712. J. J. Sarre, unpublished results.
713. Degussa, DE 1180723, 1963 (H. Biegler, W. Neugebauer, H. Kempers).
714. Degussa, DE 1933291, 1969 (A. Illigen, W. Neugebauer).
715. Lonza, DE 2337495, 1972 (C. Schnell, M. Wißler, K. Hengartner).
716. E. R. Schnell, S. M. L. Hamblyn, K. Hengartner, M. Wißler, *Powder Technol.* **20** (1978) 15.
717. Degussa, DE-AS 1467019, 1963 (A. Becker, P. Nauroth).
718. Degussa, DE-AS 1168874, 1962 (G. Roderburg, P. Nauroth).
719. Degussa, DE-AS 1299617, 1965 (H. Reinhardt, K. Achenbach, P. Nauroth).
720. Degussa, EP 0078909, 1982 (P. Nauroth, H. Esch, G. Türk).
721. Degussa, DE 1767332, 1968 (G. Türk, J. Welsch).
722. Degussa, EP-A 0341383, 1989 (D. Kerner, A. Wagner, F. Schmidt, D. Bauer).
723. Degussa, DE-OS 3114493, 1981 (P. Nauroth, R. Kuhlmann, G. Türk, A. Becker).
724. Akzo, DE-AS 2020887, 1970 (G. Steenken, E. Seeburger).
725. Rhône-Poulenc, EP 0018866, 1980 (J.-L. Ray, M. Condurier).
726. Rhône-Poulenc, EP 0170578, 1985 (Y. Chevallier).
727. Rhône-Poulenc, EP-A 0396450, 1990 (Y. Chevallier).
728. Degussa, DE-OS 3639845, 1986 (H. Reinhardt, A. Becker, R. Kuhlmann, P. Nauroth).
729. Tokuyama Soda, JP-Kokai 59141416, 1983.
730. Crosfield, US 4127641, 1977 (D. Aldcroft, D. Barby, A. L. Lovell, J. P. Quinn).
731. Huber, US 4260454, 1978 (S. K. Wason, R. K. Mays).
732. Sifrance, DE-AS 2224061, 1972 (J.-B. Donnet, B. Baudru, M. Condurier, G. Vrisakis).
733. Degussa, DE 966985, 1950 (K. Andrich).
734. Nippon Silica, JP 0375215, 1989 (Y. Mikamoto, K. Sakata).
735. Degussa, DE 1229504, 1962 (G. Kallrath).
736. Bayer, DE-OS 3525802, 1985 (L. Puppe, O. Schlak, J. Ackermann, T. Naumann).
737. Degussa, DE-AS 1192162, 1962 (L. Hüter, G. Steenken).
738. PPG, DE-AS 1131196, 1955 (F. S. Thornhill, E. M. Allen).
739. PPG, DE 1283207, 1961 (C. B. Lagerstrom).
740. Degussa, DE-AS 2505191, 1975 (B. Brandt, P. Nauroth, A. Peters, H. Reinhardt).
741. Degussa, DE-OS 1467437, 1965 (G. Bretschneider, K. Pfeiffer, R. Schwarz, K. Laun).
742. Degussa, DE-AS 1293138, 1965 (H. Reinhardt, P. Nauroth).
743. Degussa, US 4179431, 1979 (E. Kilian, A. Kreher, P. Nauroth, G. Türk).
744. Degussa, DE-AS 1567440, 1965 (H. Biegler, K. Trebinger).
745. Degussa, *Schriftenreihe Pigmente*, Paper no. 70, 2nd ed., Frankfurt/Main 1984.
746. Degussa, *Schriftenreihe Pigmente*, Paper no. 28, 5th ed., Frankfurt/Main 1991.
747. Degussa, *Schriftenreihe Pigmente*, Paper no. 32, 4th ed., Frankfurt/Main 1989.
748. H. Ferch, *Chem. Ing. Tech.* **48** (1976) no. 11, 922.
749. Degussa, DE 1172245, 1963 (G. Kallrath).
750. Degussa, DE 2513608, 1975 (H. Reinhardt, K. Trebinger, G. Kallrath).
751. Degussa, DE 2729244, 1977 (P. Nauroth et al.).
752. Degussa, DE 1074559, 1959.
753. Degussa, DE 2628975, 1976 (P. Nauroth et al.).
754. Degussa, DE 1667465, 1967 (P. Nauroth, R. Kuhlmann).
755. Degussa, DE 1592865, 1967 (O. Kühnert, G. Turk, E. Eisenmenger).
756. Degussa, *Schriftenreihe Pigmente*, Paper no. 16 4th ed., Frankfurt/Main 1990.
757. H. J. Bachmann, J. W. Sellers, M. P. Wagner, R. F. Wolf, *Rubber Chem. Technol.* **32** (1959) 1286.
758. G. Kraus: *Reinforcement of Elastomers*, Interscience, New York 1965.
759. S. Wolff, *Kautsch. Gummi Kunstst.* **41** (1988) no. 7, 674.
760. Degussa, *Schriftenreihe Pigmente*, Paper no. 5, Frankfurt/Main 1982.
761. S. Wolff, *Kautsch. Gummi Kunstst.* **34** (1981) no. 4, 280.
762. S. Wolff, *Kautsch. Gummi Kunstst.* **36** (1983) no. 11, 969.
763. Degussa, DE-OS 3305373, 1983 (S. Wolff, P. Golombeck).
764. R. Bode, A. Reiser, *Kautsch. Gummi Kunstst.* **32** (1979) no. 2, 89.
765. P. Vondracek, M. Schätz, *Kautsch. Gummi Kunstst.* **33** (1980) no. 9, 699.
766. Degussa, *Schriftenreihe Pigmente*, Paper no. 13, 4th ed., Frankfurt/Main 1986.
767. Degussa, *Schriftenreihe Pigmente*, Paper no. 43, 1984.
768. K. H. Müller, *Mühle Mischfuttertech.* **114** (1977) 28.
769. K. H. Müller, *Kraftfutter* **53** (1970) 436.
770. Degussa, *Schriftenreihe Pigmente*, Paper no. 30, 3rd ed., Frankfurt/Main 1990.
771. Degussa, *Schriftenreihe Pigmente*, Paper no. 1, 5th ed., Frankfurt/Main 1989.
772. O. Pifrenge, *Fette Seifen Anstrichm.* **63** (1961) no. 5, 445.
773. Degussa, *Schriftenreihe Pigmente*, Paper no. 9, 3rd ed., Frankfurt/Main 1988.
774. Degussa, *Schriftenreihe Pigmente*, Paper no. 2, Frankfurt/Main 1983.
775. Degussa, *Schriftenreihe Pigmente*, Paper no. 42, 3rd ed., Frankfurt/Main 1986.
776. W. Leonhardt, *Speciality Chemicals* **1989**, 441.
777. K. H. Müller, W. Barthel, *Die Asphaltstraße* **1990**, no. 6, 22.
778. Degussa, EP-A 0434944, 1990 (K. H. Müller, W. Barthel).
779. Degussa, DE 1517900, 1965 (H. Reinhardt, P. Nauroth, K. Achenbach).
780. General Electric, US 4018564, 1975 (J. H. Wright).
781. R. M. Barrer: "Porous Crystals: A Perspective" in Y. Murakami, A. Jijima, J. W. Ward (eds.): *New Developments in Zeolites Science and Technology*, Kodansha, Tokyo, and Elsevier, Amsterdam, Tokyo 1986, pp. 3-11.
782. E. M. Flannigan et al., *Nature* **271** (1978) 512-516.
783. W. M. Meier, D. H. Olson: *Atlas of Zeolite Structure Types*, Butterworth, London 1987.
784. H. Gies, B. Marler, *Zeolites* **12** (1992) 42-49.
785. R. Szostak: "Modified Zeolites" in H. van Bekkum, E. M. Flannigan, J. C. Jansen (eds.): *Introduction to Zeolite Science and Practice*, Elsevier, Amsterdam 1991, pp. 153-199.
786. H. Gies et al., *Neues Jahrb. Mineral. Monatsh.* **3** (1982) 119-124.
787. B. Marler, *Phys. Chem. Miner.* **16** (1988) 286-290.
788. J. F. Cooper, Jr., G. E. Dunning, *Am. Mineral.* **57** (1972) 1494-1499.
789. C. A. Fyfe, H. Gies, *J. Inclusion Phenom.* **8** (1990) 235-239.
790. H. Gies, *Z. Kristallogr.* **167** (1984) 13-82.
791. C. A. Fyfe et al., *Zeolites* **10** (1990) 278-282.
792. C. A. Fyfe et al., *J. Am. Chem. Soc.* **110** (1988) 3373-3380.
793. C. A. Fyfe et al., *J. Am. Chem. Soc.* **111** (1989) 2470-2474.
794. J. A. Ripmeester et al., *J. Chem. Soc., Chem. Commun.* **1988**, 608-611.
795. N. Y. Chen, *J. Phys. Chem.* **80** (1976) 60-64.
796. D. H. Olson et al., *J. Catal.* **61** (1980) 390-396.
797. R. M. Lago et al.: "The Nature of the Catalytic Sites in HZSM-5-Activity Enhancement" in Y. Murakami, A. Jijima, J. W. Ward (eds.): *New Developments in Zeolite Science and Technology*, Elsevier, Amsterdam 1986, pp. 677-684.
798. T. Bein et al.: "Molecular Sieve Films from Zeolite-Silica Microcomposites" in P. A. Jacobs, R. A. van Santen (eds.): *Zeolites: Facts, Figures, Future*, Elsevier, Amsterdam 1989, pp. 887-896.
799. Y. S. Lin, Y. H. Ma: "A Comparative Study of Adsorption and Diffusion of Vapor Alcohols and Alcohols from Aqueous Solutions in Silicalite" in P. A. Jacobs, R. A. van Santen (eds.): *Zeolites: Facts, Figures, Future*, Elsevier, Amsterdam 1989, pp. 877-886.
800. P. Enzel, T. Bein, *J. Phys. Chem.* **93** (1989) 6270-6272.
801. S. D. Cox, G. D. Stucky, *J. Phys. Chem.* **95** (1991) 710-720.
802. N. Herron, Y. Wang, *J. Phys. Chem.* **91** (1987) 2757.
803. S. Miyazaki, H. Yoneuyama, *Denki Kagaku* **58** (1990) 37-40.
804. S. T. Homeyer, W. M. H. Sachtler: "Design of Metal Clusters in NaY Zeolite" in P. A. Jacobs, R. A. van Santen (eds.): *Zeolites: Facts, Figures Future*, Elsevier, Amsterdam 1989, pp. 975-984.
805. K. Möller et al., *J. Phys. Chem.* **93** (1989) 6116-6120.
806. S. D. Cox et al., *Chem. Mater.* **2** (1990) 609-619.
807. G. Ozin et al., *Angew. Chem.* **101** (1989) 373-390.
808. H. Gies et al., *Angew. Chem.* **94** (1982) 214-215.
809. H. K. Chae et al.: "Clathrasils: New Materials for Nonlinear Optics" in G. Stucky (ed.): "New Materials for Nonlinear Optics", *Am. Chem. Soc. Symp. Ser.* **1991**.
810. H. Gies: "Clathrasils and Zeosils: Inclusion Compounds with Silica Host Framework" in J. L. Atwood, J. E. D. Davies, D. D. McNicol (eds.): *Inclusion Compounds*, vol. 5, Inorganic and Physical Aspects of Inclusion, Oxford University Press, Oxford 1991, pp. 1-36.
811. K. R. Franklin, B. M. Lowe, *Zeolites* **8** (1988) 491-516.
812. E. W. Valyocic, L. D. Rollman, *Zeolites* **5** (1985) 123-125.
813. G. T. Kerr, *J. Phys. Chem.* **71** (1967) 4165.
814. C. A. Fyfe et al., *J. Chem. Soc., Chem. Commun.* **1984**, 1093-1094.

810. "Silica Flour: Silicosis", NIOSH, *Current Intelligence Bulletin* no. 36, 1981. DHHS (NIOSH) Publication no. 81-137, 1981.
811. Information Profiles on Potential Occupational Hazards, vol. II, Chemical Classes: Amorphous Silicas, NTIS, no. PB81-147886, 1979.
812. *Patty*: 3rd ed., 2B, p. 3012.
813. D. D. Dunnom (ed.): "Health Effects of Synthetic Silica Particulates", *ASTM Spec. Tech. Publ.* 732 (1981) no. 04-732000-17.
814. E. Quellmalz: "Silikogener Staub", *Das neue Chemikaliengesetz: Arbeitsstoffverordnung Anhang 11, 12/2.8*, WEKA-Verlag, Kissing 1982.
815. Deutsche Forschungsgemeinschaft (ed.): *MAK- und BAT-Wert-Liste*, VCH, Weinheim 1992, pp. 96-102.
816. *Documentation of the Threshold Limit Values*, 4th ed. 1980, Suppl. Docum. 1981, Silica (amorphous), p. 362, Silica (fused), p. 363, Silica (quartz), p. 364. *Am. Cong. Gov. Ind. Hyg.*, Cincinnati, OH, 1981.
817. V. Klosterkötter, *Arch. Hyg. Bakteriologie* 149 (1965) 577-598.
818. W. H. Schepers et al.: *AMA Arch. Ind Health* 16 (1957) 125-146.
819. H. Volk, *Arch. Environ. Health* 1 (1960) 125-128.
820. H. Gerofke: *Beobachtungen an Beschäftigten des Aerosil-Betriebes*, Rheinfelden 1981, unpublished.
821. V. C. Vitums et al.: *Arch. Environ. Health* 32 (1977) no. 2, 62-68.
822. F. D. Goldsmith, T. L. Guidotti, D. R. Johnston: *Am. J. Ind. Med.* 3 (1982) 423.
823. P. Westerholm: *Scand. J. Work Environm. Health (Suppl.)* 2/6 (1980) 1.
824. M. Finkelstein, R. Kusiak, G. Suranyi: *J. Occup. Med.* 24 (1982) 663.
825. H. Gulbergsson, K. Kurppa, H. Koskinen, M. Vasama: "Association between Silicosis and Lung Cancer: A Register Approach", *VII. International Pneumocoinosis Conference*, Bochum, Sept. 20-23, 1983.
826. C. G. O'Neill et al.: *Lancet* 202 (1982) 1202.
827. W. Klosterkötter, H. J. Einbrodt: *Arch. Hyg. Bakteriologie* 149 (1965) 367-384.
828. W. Klosterkötter: *Retention, Penetration und Elimination von Quarz bei einem Langzeit-Inhalationsversuch (Konzentration 10 mg/m<sup>3</sup>)* vol. 9, Verlag Glückauf, Essen 1973, p. 177.
829. H. Gärtner: *Arch. Hyg. Bakt.* 136 (1952) 451-461.
830. K. W. Jötten: *Gutachtliche Untersuchung und Beurteilung der Wirkung von Aerosilstaub auf das Lungengewebe von Versuchstieren*, Deutsche Gold- und Silber-Scheideanstalt, Frankfurt am Main 1952.
831. M. M. E. Wagner: *J. Natl. Cancer Inst.* 57 (1976) 509.
832. M. M. E. Wagner, J. C. Wagner, R. Davies, D. M. Griffiths: *Br. J. Cancer* 41 (1980) 908.
833. F. Stenback, J. Rowland: *Oncology* 36 (1979) 63.
834. L. M. Holland, M. Gonzales, J. S. Wilson, M. I. Tillery: "Pulmonary Effects of Shale Dusts in Experimental Animals", *Environmental Health Conference*, Park City, April 6-9, 1982.

## 49 Boron

ULRICH BAUDIS (§ 49.1 EXCEPT 49.1.1); ROBERT A. SMITH (§§ 49.1.1, 49.7-49.13); ROBERT J. BROTHERTON, C. JOSEPH WEBER (§§ 49.2-49.3); CLARENCE GUIBERT, JOHN L. LITTLE (§§ 49.4-49.5); JOSEPH A. CORELLA (§§ 49.4-49.5); ALFRED LIPP, KARL A. SCHWETZ (§§ 49.6); GÜNTER ETZRODT (§ 49.14)

|   |      |  |      |
|---|------|--|------|
| 49.1 The Element  | 1985 | 49.4.1.3 Uses                                    | 2000 |
| 49.1.1 Occurrence   | 1986 | 49.4.2 Borohydrides                              | 2001 |
| 49.1.2 Structure and Polymorphism                             | 1987 | 49.5 Toxicology and Occupational Health          | 2001 |
| 49.1.3 Physical Properties                                    | 1988 | 49.6 Metal Borides                               | 2002 |
| 49.1.4 Chemical Properties                                    | 1988 | 49.6.1 Properties                                | 2002 |
| 49.1.5 Production   | 1989 | 49.6.2 Production                                | 2005 |
| 49.1.6 Chemical Analysis, Storage, Safety                     | 1990 | 49.6.3 Uses                                      | 2005 |
| 49.1.7 Uses, Economic Aspects                                 | 1991 | 49.7 Boric Oxide                                 | 2006 |
| 49.2 Boron Halides  | 1991 | 49.7.1 Physical Properties                       | 2006 |
| 49.2.1 Physical Properties                                    | 1991 | 49.7.2 Chemical Properties                       | 2006 |
| 49.2.2 Chemical Properties                                    | 1992 | 49.7.3 Production                                | 2007 |
| 49.2.2.1 Exchange Reactions                                   | 1992 | 49.8 Boric Acid                                  | 2007 |
| 49.2.2.2 Halide Displacement Reactions                        | 1992 | 49.8.1 Physical Properties                       | 2007 |
| 49.2.2.3 Boron Trihalides as Lewis Acids                      | 1993 | 49.8.2 Chemical Properties                       | 2010 |
| 49.2.2.4 Reduction Reactions                                  | 1993 | 49.8.3 Production                                | 2010 |
| 49.2.3 Production   | 1993 | 49.9 Aqueous Borate Solutions                    | 2011 |
| 49.2.4 Quality Specifications, Chemical Analysis              | 1994 | 49.10 Sodium Borates                             | 2012 |
| 49.2.5 Sources, Handling, and Transportation                  | 1994 | 49.11 Other Metal Borates                        | 2016 |
| 49.2.6 Uses of Boron Trihalides                               | 1994 | 49.11.1 Calcium and Calcium Sodium Borates       | 2016 |
| 49.2.7 Pollution Control, Toxicology, and Occupational Health | 1995 | 49.11.2 Lithium, Potassium, and Ammonium Borates | 2016 |
| 49.2.8 Fluoroboric Acid and Fluoroborates                     | 1995 | 49.11.2.1 Lithium Borates                        | 2016 |
| 49.2.8.1 Physical and Chemical Properties                     | 1995 | 49.11.2.2 Potassium Borates                      | 2017 |
| 49.2.8.2 Production   | 1996 | 49.11.2.3 Ammonium Borates                       | 2017 |
| 49.2.8.3 Quality Specifications, Chemical Analysis            | 1996 | 49.11.3 Zinc Borates                             | 2018 |
| 49.2.8.4 Sources, Handling, and Transportation                | 1996 | 49.12 Borate Glasses                             | 2018 |
| 49.2.8.5 Uses   | 1997 | 49.13 Miscellaneous Data                         | 2019 |
| 49.2.8.6 Pollution Control, Toxicology                        | 1997 | 49.13.1 Quality Specifications                   | 2019 |
| 49.2.9 Boron Subhalides                                       | 1997 | 49.13.2 Uses                                     | 2019 |
| 49.3 Boron Sulfide  | 1998 | 49.13.3 Economic Aspects                         | 2020 |
| 49.3.1 Physical and Chemical Properties                       | 1998 | 49.13.4 Toxicology and Occupational Health       | 2021 |
| 49.3.2 Production   | 1998 | 49.14 Pigments                                   | 2021 |
| 49.3.3 Uses   | 1998 | 49.14.1 Borosilicate Pigments                    | 2021 |
| 49.4 Boranes  | 1998 | 49.14.2 Borate Pigments                          | 2021 |
| 49.4.1 Diborane and Higher Boranes                            | 1998 | 49.15 References                                 | 2021 |
| 49.4.1.1 Physical and Chemical Properties                     | 1999 |  |      |
| 49.4.1.2 Production   | 2000 |  |      |

### 49.1 The Element

The nonmetallic element boron is situated in the top position of the third main group in

the periodic table. Boron is not found free in nature but is always bound to oxygen. It occurs as orthoboric acid and as alkali-metal and alkaline earth metal borates. The most impor-

tant sources of boron are the minerals rasorite and kernite, which are found in extensive deposits in California in the Mojave desert. There are also large ore deposits in Turkey and the former USSR. Although widespread in nature, boron constitutes only about 3 ppm of the earth's crust [9].

Boron was discovered concurrently by the French chemist GAY-LUSSAC and the English chemist SIR HUMPHRY DAVY in 1808. HENRI MOISSAN [10] first obtained considerable quantities of boron (of 86% purity) by reduction of boric oxide with magnesium in 1895. The Moissan process is still the basis for commercial production of amorphous low-purity boron.

In 1909 WEINTRAUB [11] succeeded in preparing 99% pure boron by decomposition of  $\text{BCl}_3$  in an electric arc. Since then numerous methods have been developed, but still research continues to find methods for producing commercial quantities of pure boron.

#### 49.1.1 Occurrence

In nature boron always occurs in the oxygenated state, mainly as borates. The structure of these covalently bonded boron-oxygen compounds consists of either planar  $\text{BO}_3$  units with  $120^\circ$  between bonds or tetrahedral  $\text{BO}_4$  units. In addition, boron is the only light element having two abundant isotopes,  $^{10}\text{B}$  (18.8%) and  $^{11}\text{B}$  (81.2%).

Boron is found in the earth's crust at an average concentration of about 10 ppm. Large deposits of commercially valuable boron minerals are only found in a few localities, usually sites of earlier intense volcanic activity. There are about 150 known boron-containing minerals [12], and of these only tincal, colemanite, ulexite, kernite, probertite, and szaibelyite are of significant commercial importance (Table 49.1).

The Arabic word for borax, baurach, is found in old manuscripts from ancient Persia and Arabia dating 2000 years ago. Tincal, the mineral name for borax decahydrate, derives

from tincana, the Sanskrit word for borax. Borates were known before Babylonian times to be useful as a flux for welding gold and have been found in enamels from China as early as 300 B.C. At the end of the 13th century Marco Polo brought borax from Mongolia to Europe. This became the primary European source for use as a soldering and enameling agent. In Turkey borates have been known since the 13th century but have been little used until recently. In 1772 boric acid or sassolite was discovered in hot springs located in Tuscany, Italy. About 1836, borates were discovered in Chile and Argentina, and these deposits quickly became the major source of world borates until the end of the century. By 1864 borates had been discovered in California and Nevada (USA).

The large sodium borates deposit of United States Borax & Chemical Corp. was discovered in California in 1913. Production began in 1927, and this has become the principal world source of refined sodium borates and boric acid. Reserves include tincal, kernite, and ulexite. American Borate Corp. near Death Valley in California produces colemanite and ulexite. Kerr McGee Chemical Corp. extracts borates from brines located at Searles Lake in California.

Reserves and production of borates in Turkey are operated by Etibank, a government controlled corporation [13]. A large sodium borates deposit found at Kirka has reserves of tincal and kernite, estimated at  $500 \times 10^6$  t, which are very similar to the deposit in California. The Kirka reserve is by far the largest known borate deposit. A new refinery designed to produce sodium borates is near completion at Kirka. Much smaller deposits of colemanite are found at Bigadic, Keatelek, and Hisarcik. Ulexite is also found at Bigadic. Colemanite and ulexite are the principal minerals mined and sold today. However, major expansion for production of refined products is reported to be under construction.

Table 49.1: Important borate minerals.

| Mineral                | Formula  | %  |                      | Location |   |
|------------------------|--|--|----------------------|----------|---|
|                        |  | $\text{B}_2\text{O}_3$   | $\text{H}_2\text{O}$ |          |   |
| Tincal, borax          | $\text{Na}_2\text{O} \cdot 2\text{B}_2\text{O}_3 \cdot 10\text{H}_2\text{O}$                   | $\text{Na}_2\text{B}_4\text{O}_7 \cdot 10\text{H}_2\text{O}$                 | 36.5                 | 47.2     | Boron, California, USA; Turkey; Argentina                           |
| Tincalconite           | $\text{Na}_2\text{O} \cdot 2\text{B}_2\text{O}_3 \cdot 5\text{H}_2\text{O}$                    | $\text{Na}_2\text{B}_4\text{O}_7 \cdot 5\text{H}_2\text{O}$                  | 47.8                 | 30.9     | California, USA; Turkey; Argentina                                  |
| Kernite                | $\text{Na}_2\text{O} \cdot 2\text{B}_2\text{O}_3 \cdot 4\text{H}_2\text{O}$                    | $\text{Na}_2\text{B}_4\text{O}_7 \cdot 4\text{H}_2\text{O}$                  | 50.9                 | 26.4     | Boron, California, USA; Argentina                                   |
| Ulexite                | $\text{Na}_2\text{O} \cdot 2\text{CaO} \cdot 5\text{B}_2\text{O}_3 \cdot 16\text{H}_2\text{O}$ | $\text{NaCaB}_5\text{O}_9 \cdot 8\text{H}_2\text{O}$                         | 43.0                 | 35.6     | California, USA; Nevada, USA; Argentina; Chile; Peru; Tibet; Turkey |
| Colemanite             | $2\text{CaO} \cdot 3\text{B}_2\text{O}_3 \cdot 5\text{H}_2\text{O}$                            | $\text{Ca}_2\text{B}_6\text{O}_{11} \cdot 5\text{H}_2\text{O}$               | 50.8                 | 21.9     | Turkey, California, USA; Nevada, USA; Mexico                        |
| Pandermite, priceite   | $4\text{CaO} \cdot 5\text{B}_2\text{O}_3 \cdot 7\text{H}_2\text{O}$                            | $\text{Ca}_4\text{B}_{10}\text{O}_{19} \cdot 7\text{H}_2\text{O}$            | 49.8                 | 18.1     | Turkey  |
| Hydroboracite          | $\text{CaO} \cdot \text{MgO} \cdot 3\text{B}_2\text{O}_3 \cdot 6\text{H}_2\text{O}$            | $\text{CaMgB}_6\text{O}_{11} \cdot 6\text{H}_2\text{O}$                      | 50.5                 | 26.2     | Caucasus, Russia; Argentina   |
| Inyoite                | $2\text{CaO} \cdot 3\text{B}_2\text{O}_3 \cdot 13\text{H}_2\text{O}$                           | $\text{Ca}_2\text{B}_6\text{O}_{11} \cdot 13\text{H}_2\text{O}$              | 37.6                 | 42.2     | Kazakhstan; Argentina   |
| Ascharite, szaibelyite | $2\text{MgO} \cdot \text{B}_2\text{O}_3 \cdot \text{H}_2\text{O}$                              | $\text{Mg}_2\text{B}_2\text{O}_5 \cdot \text{H}_2\text{O}$                   | 41.4                 | 10.7     | Former USSR; China  |
| Datolite               | $2\text{CaO} \cdot \text{B}_2\text{O}_3 \cdot 2\text{SiO}_2 \cdot \text{H}_2\text{O}$          | $\text{Ca}_2\text{B}_2\text{Si}_2\text{O}_9 \cdot \text{H}_2\text{O}$        | 21.8                 | 5.6      | Kazakhstan  |
| Meyerhofferite         | $2\text{CaO} \cdot 3\text{B}_2\text{O}_3 \cdot 7\text{H}_2\text{O}$                            | $\text{Ca}_2\text{B}_6\text{O}_{11} \cdot 7\text{H}_2\text{O}$               | 46.7                 | 28.2     | Turkey  |
| Inderite               | $2\text{MgO} \cdot 3\text{B}_2\text{O}_3 \cdot 15\text{H}_2\text{O}$                           | $\text{Mg}_2\text{B}_6\text{O}_{11} \cdot 15\text{H}_2\text{O}$              | 37.3                 | 48.3     | Argentina   |
| Howlite                | $4\text{CaO} \cdot 5\text{B}_2\text{O}_3 \cdot 2\text{SiO}_2 \cdot 5\text{H}_2\text{O}$        | $\text{Ca}_4\text{B}_{10}\text{Si}_2\text{O}_{21} \cdot 5\text{H}_2\text{O}$ | 44.4                 | 11.5     | Mexico; Turkey  |
| Probertite             | $\text{Na}_2\text{O} \cdot 2\text{CaO} \cdot 5\text{B}_2\text{O}_3 \cdot 10\text{H}_2\text{O}$ | $\text{NaCaB}_5\text{O}_9 \cdot 5\text{H}_2\text{O}$                         | 49.6                 | 25.6     | California, USA   |
| Sassolite              | $\text{B}_2\text{O}_3 \cdot 3\text{H}_2\text{O}$   | $\text{H}_3\text{BO}_3$  | 56.3                 | 43.7     | Tuscany, Italy  |
| Boracite               | $5\text{MgO} \cdot \text{MgCl}_2 \cdot 7\text{B}_2\text{O}_3$                                  | $\text{Mg}_3\text{B}_7\text{O}_{13}\text{Cl}$                                | 62.2                 | —        | Turkey  |

Both tincal and ulexite are found in Argentina and ulexite is found in Peru. Borate reserves in Kazakhstan are found in the Inder district, and consist principally of szaibelyite and hydroboracite. Although production in the former USSR is relatively small, reserves are believed to be extensive. Ascharite, a magnesium borate, is the source of most borates produced in China.

#### 49.1.2 Structure and Polymorphism

There are several allotropic forms of boron. Well established are amorphous boron,  $\alpha$ -rhombohedral boron, and  $\beta$ -rhombohedral boron. In addition, four tetragonal forms have been described. However, these are probably stabilized by small amounts of nitrogen or carbon [4].

The  $\beta$ -rhombohedral form is the thermodynamically stable modification at all temperatures. Amorphous boron slowly converts to

the  $\beta$ -rhombohedral form at  $\approx 1200^\circ\text{C}$  and to  $\alpha$ -rhombohedral boron above  $1500^\circ\text{C}$ . Any type of boron recrystallizes in  $\beta$ -rhombohedral structure when heated above the melting point and cooled.

The unit cell of  $\beta$ -rhombohedral boron contains 105 boron atoms grouped  $84\text{B} + 2 \times 10\text{B} + 1\text{B}$  in a complex arrangement. The structure of  $\alpha$ -rhombohedral boron can be described as a slightly deformed cubic close packing of B12 icosahedra. The unit cell contains 12B atoms at the vertices of the icosahedron.

Amorphous boron exhibits broad reflections in the x-ray diffraction pattern. It is believed to be a frozen-in intermediate between the  $\alpha$ - and  $\beta$ -modifications or a microcrystalline deposit of  $\beta$ -rhombohedral boron [4]. Amorphization can be achieved by intensive milling of  $\beta$ -rhombohedral samples [14]. Structures of the other polymorphs are too complex to be described in a few words; however all boron structures have been discussed thoroughly elsewhere [4].

### 49.1.3 Physical Properties

Determination of precise physical properties of boron is made more complicated by the structural polymorphism and purification problems. Some recent values, rather arbitrarily collected from the literature, are listed below.

|   |  |                             |
|---|--|-----------------------------|
| Atomic number                                 | 5  |                             |
| Relative atomic mass                          | 10.811   |                             |
| Melting point (°C)                            | 2050 ± 50  |                             |
| Sublimation point (°C)                        | 2550   |                             |
| Density (20 °C)                               | 2.3  | amorphous                   |
| (g/cm <sup>3</sup> )                          | 2.35   | β-rhombohedral              |
|   | 2.46   | α-rhombohedral              |
|   | 2.99   | liquid at <i>mp</i>         |
|   | 2.13   | solid at <i>mp</i>          |
| Crystal structure                             | amorphous, α-rhombohedral, β-rhombohedral, four tetragonal |                             |
| Hardness (Knoop)                              | 2390   | crystallized from melt      |
| (kg/mm <sup>2</sup> )                         | 2690   | vapor deposited             |
| Electrical resistivity                        | 7.5 × 10 <sup>2</sup>                                      | amorphous                   |
| (300 K) (Ωcm)                                 | 7 × 10 <sup>5</sup>  | β-rhombo., single crystal   |
|   | 10 <sup>6</sup> –10 <sup>7</sup>                           | β-rhombo., polycrystal-line |
| Heat capacity <i>C<sub>p</sub></i>            | 12.054   | amorphous at 300 K          |
| (JK <sup>-1</sup> mol <sup>-1</sup> )         | 11.166   | β-rhombo. at 300 K          |
|   | 33.955   | solid at <i>mp</i>          |
|   | 39.063   | liquid at <i>mp</i>         |
| Entropy <i>S</i> (298 K)                      | 6.548  | amorphous                   |
| (JK <sup>-1</sup> mol <sup>-1</sup> )         | 5.875  | β-rhombohedral              |
| Enthalpy of fusion                            | 50.2   |                             |
| $\Delta H_f$ (kJ/mol)                         |  |                             |
| Enthalpy of sublimation $\Delta H_s$ (kJ/mol) | 572.7  |                             |

Boron is the second hardest element, the diamond allotrope of carbon being the hardest. α-Rhombohedral boron is red to brown; β-rhombohedral boron lustrous gray black; and amorphous material is brown to gray. The electrical resistivity changes drastically with temperature, varying from 10<sup>11</sup> Ωcm at -160 °C to 10<sup>6</sup> Ωcm at 20 °C and to 0.1 Ωcm at 700 °C [4] for polycrystalline β-rhombohedral boron, behavior characteristic of a semiconductor. Detailed information about optical, magnetic, electrical, thermodynamic, and other properties of the various boron polymorphs are given in the literature [4, 5].

Boron is composed of two stable isotopes, <sup>10</sup>B and <sup>11</sup>B. Their nuclear properties are summarized in Table 1. The nuclear spin permits NMR spectroscopy. The high value of thermal neutron cross section of the isotope <sup>10</sup>B makes

boron useful as a neutron absorber in nuclear power plants.

### 49.1.4 Chemical Properties

The chemical properties of boron are determined to a large extent by its small atomic radius (0.25 nm) and high ionization potentials.

|   |  |
|---|--|
| Ionization energy (kJ/mol)  |  |
| B → B <sup>+</sup>  | 798 (8.27 eV)                            |
| B <sup>+</sup> → B <sup>2+</sup>  | 2426 (25.15 eV)                          |
| B <sup>2+</sup> → B <sup>3+</sup>   | 3658 (37.92 eV)                          |
| Standard electrode potential  |  |
| B + 3H <sub>2</sub> ⇌ OH <sub>3</sub> BO <sub>3</sub> + 3H <sub>2</sub> + 3e <sup>-</sup> | -0.73 V                                  |
| Electron affinity (kJ/mol)  |  |
|   | 32 (0.332 eV)                            |
| Electronegativity   |  |
|   | 2.04 (Pauling)                           |
|   | 2.01 (Mulliken)                          |
| Ionic radius (nm)   |  |
|   | 0.25                                     |
| Atomic radius (nm)  |  |
|   | 0.80–0.95 (depending on type of bonding) |
| Standard enthalpy of formation (kJ/mol)   |  |
| BF <sub>3</sub>   | -1136                                    |
| BCl <sub>3</sub>  | -402                                     |
| BBr <sub>3</sub>  | -239                                     |
| B <sub>2</sub> O <sub>3</sub>   | -1269                                    |
| BN  | -256                                     |

The electronic configuration 2s<sup>2</sup>2p<sup>1</sup> dictates predominant trivalency. However, simple B<sup>3+</sup> ions do not exist.

Because boron has more orbitals available for bonding than electrons (4 orbitals, 3 electrons), it is an electron-pair acceptor, a Lewis acid, and it has a tendency to form multi-center bonds. Other dominant characteristics are the high affinity for oxygen and the tendency to combine with most metals to give refractory alloylike metal borides.

Table 49.2: Nuclear properties of boron.

| Property  | Nuclide         |                 |
|---|-----------------|-----------------|
|   | <sup>10</sup> B | <sup>11</sup> B |
| Relative atomic mass                            | 10.0129         | 11.0093         |
| Natural abundance, %                            | 19.8            | 80.2            |
| Nuclear spin                                    | +3              | -3/2            |
| Magnetic moment, nuclear magnetons <sup>a</sup> | +1.80063        | +2.68857        |
| Quadrupole moment, barn <sup>b</sup>            | +0.074          | 0.036           |
| Cross section for (n,α), barn <sup>b</sup>      | 3837            | 0.005           |

<sup>a</sup> 1 nuclear magneton = 5.0508 × 10<sup>-27</sup> Am<sup>2</sup>.

<sup>b</sup> 1 barn = 10<sup>-28</sup> m<sup>2</sup>.

The chemical behavior of elemental boron depends upon the morphology and particle size. Generally speaking, crystalline boron is rather unreactive, whereas amorphous boron does react more readily. At room temperature all modifications of boron are relatively resistant to chemical attack.

No direct reaction occurs with hydrogen, but indirect synthesis leads to a variety of boron hydrides.

The halogens react to form the trihalides:

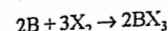

Fluorine reacts spontaneously at room temperature; chlorine, at 500 °C; and bromine, at 600 °C [15].

Reaction with oxygen starts at ≈ 600 °C but is restrained by the formation of a glassy liquid B<sub>2</sub>O<sub>3</sub> film on the boron particles [16]. Boron reacts with sulfur to form glassy B<sub>2</sub>S<sub>3</sub> and with Se to form B<sub>2</sub>Se<sub>3</sub>, both at ≈ 600 °C. There is no reaction with Te. With nitrogen, boron nitride, BN, is formed at 1100 °C. Phosphorus reacts completely at 1000 °C to give BP. Arsenic forms BAs at 800 °C under pressure.

Boron and carbon react to give B<sub>12</sub>C<sub>3</sub> above 2000 °C; with silicon, B<sub>4</sub>Si and B<sub>6</sub>Si are formed. Heterocyclic compounds containing C, N, S, O, and boron have interesting structures and properties. There is also a large variety of organoboron compounds [17].

When it does react, elemental boron is an effective reducing agent. Water vapor is reduced at 800 °C to give H<sub>2</sub> and B<sub>2</sub>O<sub>3</sub>. Carbon monoxide is reduced at 1200 °C; boron burns in carbon dioxide at red heat. Nitrogen oxides are reduced to give BN and B<sub>2</sub>O<sub>3</sub>. Sulfur dioxide is also reduced. When transition metal oxides like Fe<sub>2</sub>O<sub>3</sub>, TiO<sub>2</sub>, and Cr<sub>2</sub>O<sub>3</sub> are reacted with elemental boron, B<sub>2</sub>O<sub>3</sub> and metal borides form. Up to 1400 °C alkaline-earth oxides and aluminum oxide do not react with boron.

Boron is not attacked by aqueous NaOH but reacts completely with molten Na<sub>2</sub>CO<sub>3</sub> or molten mixtures of sodium carbonate and sodium nitrate.

Boiling nonoxidizing acids, such as HF, HCl, HBr, or dilute sulfuric or phosphoric acid, do not attack boron. However, vigorous

reaction occurs with concentrated HNO<sub>3</sub> or with HNO<sub>3</sub>-H<sub>2</sub>O<sub>2</sub> mixtures.

The chemical properties of boron are summarized in [19].

### 49.1.5 Production

A variety of preparative methods have been described. The following are the most important methods [6]:

- Reduction of boric oxide with magnesium
- Reduction of boron halides or fluoroborates with sodium or another metal
- Reduction of boron halides with hydrogen
- Thermal decomposition of boron compounds, especially boron halides and hydrides
- Electrolysis of molten borates or fluoroborates

The modification of boron formed depends primarily on temperature and reaction time, only secondarily on the method [20]. As a rule of thumb, temperature below 900 °C and short reaction time produce amorphous boron; temperature above 1400 °C and long reaction time produce β-rhombohedral or the tetragonal modifications. The optimum conditions for formation of α-rhombohedral boron are in between.

The usual method for commercial production of large quantities of amorphous boron is the *reduction of boron trioxide with magnesium* in a thermitelike reaction [21–23]. The principles of this method date back to the work of HENRI MOISSAN [10].

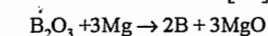

Simultaneously MgO reacts with excess B<sub>2</sub>O<sub>3</sub>:

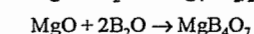
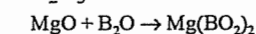

The reduction is very quick and highly exothermic; finely divided material may react explosively [7].

Reaction is smoother if there is an excess of B<sub>2</sub>O<sub>3</sub> [7, 24]:

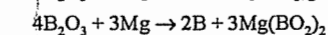
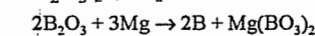



The optimum ratio  $B_2O_3:Mg$  is about 1.8:3 [7]. Reaction is carried out in vertical steel retorts shielded from oxygen by a flow of argon. It is initiated by electric spark and igniter mixture or by external heating.

After cooling, the reaction mass is crushed to 1-mm particles and leached twice with hydrochloric acid. Crude amorphous boron of 86–88% purity is obtained [23]. This material can be upgraded by treatment with  $B_2O_3$  [24] or  $KHF_2$  and  $KBF_4$  [25, 26], subsequent leaching with acid, and final heating in a vacuum to remove boron suboxide and metals [27]. The boron content is then 90–92 or 95–97%, adequate for use in pyrotechnics and fluxes.

#### Reduction of $KBF_4$ by sodium

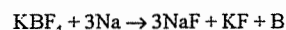

was used for the commercial production of boron in Germany until the end of the 1950s [28].

A common problem of metallothermic reduction is incomplete reaction and formation of nonremovable metal borides.

Samples of very pure boron, > 99% B, can be obtained by reduction of boron halides with hydrogen, especially  $BBr_3$  [29, 30] and  $BCl_3$  [31–34]. This is also the method of choice for laboratory synthesis [29, 31]. The halides can be purified by distillation prior to reduction [4, 29]. However, the efficiency of the hydrogen reduction process is rather low [21], yields of 5–25% being the usual. Unreacted boron halide must be recycled [32], washed out, or removed by other methods [35]. This complicates the process and makes it expensive.

Very pure boron is also obtained by thermal decomposition of  $BI_3$  [36, 37],  $BBr_3$  [38], or boron hydrides [39, 40] on tungsten wires or another type of incandescent filament. Boron of 99.9999% (six nines) purity was obtained by decomposition of diborane and subsequent zone melting [41].

Electrolysis of molten borates or  $KBF_4$  [42] is not an important method for commercial or laboratory preparation although it has been mentioned in numerous articles.

Boron can be refined either by zone melting [6, 37, 41, 43, 44] or volatilization of impurities in high vacuum or hydrogen at 2000 °C [27, 37].

### 49.1.6 Chemical Analysis, Storage, Safety

**Analysis.** Boron content in elemental boron is generally determined quantitatively by decomposition to borate with fused carbonate in a platinum crucible subsequent acid leaching neutralization addition of mannitol and titration of boric acid. The mixture  $HNO_3-H_2O_2$  also decomposes boron samples. Metal impurities in boron, such as Mg Na and Fe are determined by atomic absorption or emission spectrometry after decomposition of the sample [45]. Chlorine and fluorine are determined by titration [46]. The elements O, N, H, P, Si, and C are difficult to determine. However vacuum hot extraction and combustion methods [44, 45] or spark source mass spectrography [37, 47] can be used.

A sensitive qualitative test for boron is the green flame test. The sample is usually decomposed to methyl borate by heating a mixture of the sample sulfuric acid and methanol to ignition.

**Storage.** Dry boron is not very sensitive to oxidation. It is packaged in airtight metal drums, cardboard or plywood containers, or glass bottles [48]. Boron powder, like other combustible material, presents a dust explosion hazard. The lower explosive limit was determined to be 125 g/m<sup>3</sup> in air [49].

Boron ignites in air at 600–800 °C but does not burn violently because of the formation of a glassy boric oxide film that prevents the material from oxidizing rapidly [16]. Burning boron should be covered with sand, aluminum oxide, sodium chloride, or the like. Water must not be used, because of the formation of inflammable hydrogen. Boron is an explosion hazard when mixed with strong oxidizing agents, such as nitrites, chlorates, lead dioxide, and silver fluoride. Such mixtures can react violently and even explode [15, 16, 18].

**Safety.** Elemental boron is considered to be nontoxic because of its chemical inertness and insolubility. In contrast, most boron compounds, especially the hydrides, are extremely toxic [50]. During the production process leading to boron the possible formation of any toxic boron hydrides must be either avoided or controlled.

### 49.1.7 Uses, Economic Aspects

Relatively large quantities of amorphous boron (90 and 95% B) are used as additives in pyrotechnic mixtures, especially in flares, igniters, and delay compositions; solid rocket propellant fuels [51]; and explosives [52]. Some boron is needed for the preparation of refractory metal boride additives for cemented carbides. Boron is also a useful reducing additive in fluxes for soldering stainless steel.

Use of boron in electronics is limited to high-purity boron (> 99.99%). It is used as a ppm additive for germanium and silicon to make *p*-type semiconductors [53]. Crystalline high-purity boron is used in thermistors [54, 55] and delay lines [56]. Boron filaments have been developed as reinforcing material for light-weight, stiff composites for use in commercial and military aircraft [57]. Epoxy resins [58], polyamides, aluminum, magnesium, and other materials are the matrix [59, 60]. However, today graphite filaments have replaced boron filaments in many applications.

In nuclear technology thin films of boron are used in neutron counters [54]. Boron powder dispersed in polyethylene castings is used for shielding against thermal neutrons [61]. In addition, composites of boron with Al or Fe, especially when enriched in <sup>10</sup>B, are used as neutron shields and absorbers in nuclear reactors [61].

Boron is an effective deoxidizing agent, e.g., for production of pure copper [62]. It also is important in the preparation of amorphous magnetic metals and alloys [63]. Boron, as ferroboration, is used in microalloyed steel (0.001% B). This steel exhibits excellent resistance to stress cracks as well as improved tensile strength and hardness.

Amorphous boron of 90–92% purity costs about DM 250–300 (≈ \$100) per kg (1984). Material of higher purity is much higher in price: very pure boron (> 99.99%, four nines) may cost up to DM 10 000 (≈ \$3500) per kg and more. Boron enriched in <sup>10</sup>B costs \$9–10 per gram [61].

The leading producers are H. C. Stark, Goslar, Germany, and Kerr McGee Chemical Corp., Oklahoma, United States. There are further production facilities at Degussa AG, Frankfurt am Main; Elektroschmelzwerk Kempten, München; Union Carbide Chemical Corp., New York; NL Industrial Corp., Wilmington, Delaware, United States; Murex Ltd., Rainham, United Kingdom; and Kawecki-Billiton Corp., Arnhem, the Netherlands [64]. Boron is also produced in the former Soviet Union.

Total production is estimated to be 30–50 t/a.

Table 49.3: Physical properties of boron halides [69, 70].

|   | BF <sub>3</sub>   | BCl <sub>3</sub> | BBr <sub>3</sub> | BI <sub>3</sub> |
|---|-------------------|------------------|------------------|-----------------|
| <i>mp</i> , °C  | -127.1            | -107             | -46              | 49.9            |
| <i>bp</i> , °C  | -99.9             | 12.5             | 91.3             | 210             |
| Density, g/mL   | 1.57 <sup>a</sup> | 1.359            | 2.618            | —               |
| <i>H</i> <sup>o</sup> fusion, kJ/mol<br>(at 25 °C)                          | -1136<br>[71]     | -403<br>[72]     | -240<br>[72]     | -47<br>[72]     |
| Δ <i>S</i> <sup>o</sup> , Jmol <sup>-1</sup> K <sup>-1</sup><br>(at 25 °C)  | 254<br>[71]       | 290              | 324              | —               |
| <i>c</i> <sub>p(v)</sub> , Jmol <sup>-1</sup> K <sup>-1</sup><br>(at 25 °C) | 50.5              | 62.6             | 68.0             | —               |
| Electron affinity,<br>× 10 <sup>-19</sup> J                                 | <0<br>[73]        | 0.53<br>[73]     | 1.31<br>[73]     | 1.81<br>[73]    |
| B–X Bond energy,<br>kJ/mol  | 154.3             | 106.1            | 88.0             | 63.7            |
| B–X Bond length,<br>nm  | 0.129             | 0.175            | 0.187            | 0.210           |

<sup>a</sup> At -100 °C.

## 49.2 Boron Halides

### 49.2.1 Physical Properties

Boron forms trihalides, sometimes called trihaloboranes, with fluorine, chlorine, bromine, and iodine. The trifluoride, BF<sub>3</sub>, and trichloride, BCl<sub>3</sub>, are gases at room temperature. The tribromide, BBr<sub>3</sub>, is a liquid, and the

triiodide, BI<sub>3</sub>, is a solid. All four trihalides are colorless, but the tribromide and triiodide discolor on exposure light. A summary of some physical properties of these compounds is given in Table 49.3.

All four compounds have trigonal symmetry with X-B-X angles of 120 °C. A crystal structure has been reported for a metastable phase of BF<sub>3</sub> at 142 K in which boron atoms are trigonal prismatic with B-X<sub>eq</sub> bond lengths of 0.126–0.131 nm and B-X<sub>ax</sub> bond lengths of 0.268–0.271 nm [74].

#### 49.2.2 Chemical Properties

Trivalent boron halides are coordinatively unsaturated and their chemistry is dominated by the unfilled boron *p*<sub>z</sub> orbital. The compounds are Lewis acids and readily form adducts with a variety of electron donors. Overlap of the unfilled boron *p*<sub>z</sub> orbital with nonbonding filled orbitals on the halides decreases the electron acceptor ability of the molecule but increases the strength of the B-X bonds. The B-F bond in BF<sub>3</sub> is the strongest single bond known. The boron-halide *p*<sub>z</sub> overlap decreases with increasing size of the halide. Thus, the acceptor strength increases as BF<sub>3</sub> < BCl<sub>3</sub> < BBr<sub>3</sub> < BI<sub>3</sub>. However, the strength of the B-X bond decreases from BF<sub>3</sub> to BI<sub>3</sub>. Boron trifluoride chemistry is dominated by Lewis acid base reactions, whereas BBr<sub>3</sub> and BI<sub>3</sub> adducts are relatively unstable and halide displacement reactions predominate.

##### 49.2.2.1 Exchange Reactions

All of the boron halides undergo halide exchange reactions, but of the mixed halide species only BBr<sub>2</sub>I and BBrI<sub>2</sub> have been isolated. Exchange reactions are also known with trialkyl, triaryl, trialkoxy, and triaryloxy boranes:

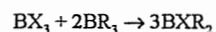

Exchange reactions between BF<sub>3</sub> and metal halides may be used to prepare other boron trihalides:

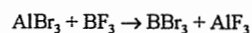
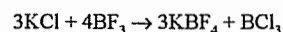

##### 49.2.2.2 Halide Displacement Reactions

Boron halides, with the exception of boron trifluoride, react readily with compounds that have active hydrogen atoms, including water, alcohols, thiols, amines, phosphines, and arsines. Because of the strength of the boron-fluorine bond, halide displacement reactions occur to a lesser extent with BF<sub>3</sub> than with other boron halides. Boron trifluoride reacts with water to give a number of partially hydrolyzed fluoroborate species including BF<sub>3</sub>OH<sup>-</sup>, BF<sub>2</sub>(OH)<sub>2</sub><sup>-</sup>, and BF(OH)<sub>3</sub><sup>-</sup>, in addition to boric acid and the fluoroborate anion, BF<sub>4</sub><sup>-</sup>. Two hydrated species, BF<sub>3</sub>·H<sub>2</sub>O and BF<sub>3</sub>·(H<sub>2</sub>O)<sub>2</sub>, can be isolated at low temperature. The dihydrate is formulated as BF<sub>3</sub>OH<sub>2</sub>·H<sub>2</sub>O based on recent structure analysis [75].

In contrast to the slow substitution reactions of BF<sub>3</sub>, other boron trihalides react vigorously with water:

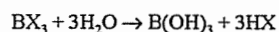

The reaction of BBr<sub>3</sub> or BI<sub>3</sub> with water may be explosive.

Most halide displacement reactions with BF<sub>3</sub> require either elevated temperature or an active nucleophile, such as a Grignard reagent:

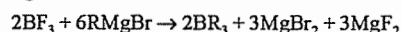

Halide displacement reactions between other boron halides and compounds with active hydrogen atoms are quite facile. The first step is often the formation of an adduct, which may be isolated at low temperature, followed by the elimination of the hydrogen halide:

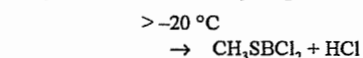
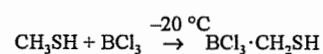
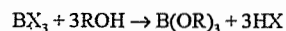

In general the reactivity of boron trihalides toward compounds with active hydrogen atoms increases with decreasing B-X bond energy,

in the order BF<sub>3</sub> < BCl<sub>3</sub> < BBr<sub>3</sub>. Side reactions leading to alkyl halides and boric acid rather than simple halide displacement are more common with the triiodide and sterically hindered alcohols.

##### 49.2.2.3 Boron Trihalides as Lewis Acids

Boron trifluoride forms adducts with a large number of electron donors including ethers, alcohols, ketones, amines, phosphines, arsines, thiols, and selenides. Those complexes with large electron donor atoms or sterically hindered bases tend to be less stable. Boron trichloride also forms many stable complexes with electron donors, but these are more prone to halide displacement reactions than are the BF<sub>3</sub> adducts. Few stable adducts are known with BBr<sub>3</sub> or BI<sub>3</sub>.

##### 49.2.2.4 Reduction Reactions

Reaction of boron halides with hydrogen, hydrides, or alkali metals often yields boron subhalides or elemental boron. If hydrogen or a hydride is used, boranes may result, e.g., in the following convenient preparation of diborane:

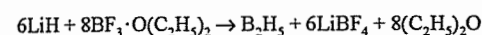

#### 49.2.3 Production

**Boron Trifluoride.** Boron trifluoride was first prepared by the reaction of boric acid and fluorspar (CaF<sub>2</sub>) at red heat [76]. Commercially, BF<sub>3</sub> has been produced by the stepwise addition of hydrofluoric acid and sulfuric acid to anhydrous borax (sodium tetraborate):

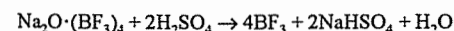
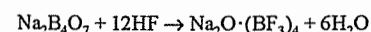

Another method involves addition of sulfuric acid and fluorspar and a source of boron, such as anhydrous borax or boric oxide (B<sub>2</sub>O<sub>3</sub>).

Recently, Polish workers have developed a process in which BF<sub>3</sub> is obtained by the reaction of HF and boric acid, using oleum as a dehydrating agent [77].

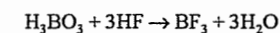

Boron trifluoride is now made commercially in the United States by a proprietary process from boric acid and hydrofluoric acid.

A variety of synthetic routes are available for the production of small quantities of BF<sub>3</sub>, including thermal decomposition of diazonium fluoroborate.

The diethyl etherate adduct, BF<sub>3</sub>·O(C<sub>2</sub>H<sub>5</sub>)<sub>2</sub>, produced by bubbling BF<sub>3</sub> into diethyl ether, provides a convenient source of BF<sub>3</sub> for many synthetic applications.

**Boron Trichloride.** This compound can be prepared by the reaction of boric oxide, a reducing agent, and chlorine in a melt at high temperatures, for example:

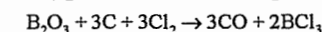

The product BCl<sub>3</sub> is recovered by fractional condensation. Sodium tetraborate Na<sub>2</sub>B<sub>4</sub>O<sub>7</sub> can be used in place of B<sub>2</sub>O<sub>3</sub>. Molten sodium chloride, formed as a by-product, settles to the bottom of the reactor [78]. A molten combination of aluminum chloride and an alkali-metal chloride has also been used as a medium for reductive chlorination of borates [79].

Free-radical chlorination of borate esters also yields BCl<sub>3</sub>:

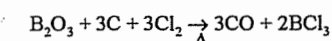

A modification of this process, in which a free-radical initiator is used, has recently been reported [80, 81]. A low reaction temperature, 40–90 °C, and the use of an initiator decrease the consumption of Cl<sub>2</sub> and prevent the formation of phosgene, COCl<sub>2</sub>.

Commercially, boron trichloride is prepared by the reaction of boron carbide with chlorine in a borate melt. This reaction can also be done with dry B<sub>4</sub>C in a fluidized-bed reactor using a transition metal halide as a catalyst [82].

Contamination of BCl<sub>3</sub> with COCl<sub>2</sub> from the chlorination of carbon oxides is a serious problem in BCl<sub>3</sub> manufacturing. Because of similar vapor pressure-temperature curves, BCl<sub>3</sub> and COCl<sub>2</sub> cannot be separated by fractional distillation. Thermal or photochemical

conversion of  $\text{COCl}_2$  to  $\text{CO}$  and  $\text{Cl}_2$  followed by fractional distillation has been used to purify  $\text{BCl}_3$ .

Boron trichloride can be prepared in the laboratory by the reaction of boron trifluoride and aluminum chloride.

**Boron Tribromide.** This compound can be prepared by the reaction of boric oxide, carbon, and bromine, or from boron carbide and bromine analogous to the chlorine reactions.

Small quantities of  $\text{BBr}_3$  can be made by the reaction of boron trifluoride and aluminum tribromide. A five-fold excess of  $\text{AlBr}_3$  increases the yield of  $\text{BBr}_3$ .

**Boron Triiodide.** Boron triiodide can be prepared by the reaction of a borohydride and iodine:

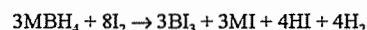

where M is lithium, sodium, or potassium.

The reaction between sodium borohydride and iodine in dimethylformamide (DMF) results in  $\text{BI}_3 \cdot 4\text{DMF}$  [83]. Boron triiodide can also be made by exchange reactions between  $\text{AlI}_3$  and  $\text{BF}_3$ , or between  $\text{LiI}$  and  $\text{LiBH}_4$ . Contrary to an earlier report, boron triiodide can be prepared from the elements by the reaction of amorphous boron with iodine at  $870^\circ\text{C}$  [84].

#### 49.2.4 Quality Specifications, Chemical Analysis

Boron trifluoride is available in quantity as a 99% pure gas. Boron trichloride is typically sold as a 99.9% pure liquid. Boron tribromide is offered in grades up to 99.9999% for electronic applications.

Common impurities in  $\text{BF}_3$  include air, silicon tetrafluoride, and sulfur dioxide. The major impurities in boron trichloride are phosgene and chlorine. Boron tribromide typically contains traces of bromine.

The boron halides may be analyzed by hydrolysis followed by analysis of  $\text{B}_2\text{O}_3$  and the halide, or by base titration. The concentration of phosgene ( $\text{COCl}_2$ ) in  $\text{BCl}_3$  may be determined by infrared spectroscopy. The trifluo-

ride, trichloride, and tribromide may be purified by fractional distillation.

#### 49.2.5 Sources, Handling, and Transportation

Allied Corp. is the major producer of boron trifluoride. Boron trifluoride complexes with monoethylamine, phenol, and diethyl ether are also available in large quantities from Allied. Complexes of  $\text{BF}_3$  with water, dimethylamine, monoethylamine, phosphoric acid, and piperidine are available from Harshaw/Filtrol. Kerr-McGee Corp. is the major producer of  $\text{BCl}_3$  and  $\text{BBr}_3$ . Boron trifluoride and trichloride are available in steel cylinders. Boron tribromide is available in glass bottles. Boron tribromide for use in electronics is supplied by J. C. Schumacher Co. in specially sealed glass vessels equipped with teflon valves. Boron triiodide is available in small quantities from the Ventron Division of Morton-Thiokol Inc.

Boron trifluoride and boron trichloride sold for \$6.83/kg (\$3.10/lb) and \$8.38/kg (\$3.80/lb) in bulk in 1984. The 1982 price for  $\text{BBr}_3$  was \$57/kg (\$26/lb) in large quantities from Kerr-McGee.

Boron trifluoride is the largest volume boron halide. The total annual production of  $\text{BF}_3$  and its adducts is about 2300–4500 t/a. The annual production of  $\text{BCl}_3$  is about 225–450 t/a. The annual production rate of  $\text{BBr}_3$  is significantly less than that of  $\text{BCl}_3$ .

The boron trihalides are nonflammable. But because they hydrolyze easily, care should be taken to avoid exposure to moisture. The DOT classification for  $\text{BCl}_3$  and  $\text{BBr}_3$  is corrosive liquid;  $\text{BF}_3$  is classified as a nonflammable gas. Equipment for conveying the compounds should be flushed with dry air prior to use. Stainless steel lines and valves are suitable for use with all dry boron halides.

#### 49.2.6 Uses of Boron Trihalides

**Boron Trifluoride.** Boron trifluoride is the most widely used boron halide. Most applications take advantage of its strong Lewis acidity. The most important uses are in organic

syntheses. Boron trifluoride is commonly used as a catalyst for Friedel-Crafts alkylation reactions. It also is used to catalyze the cleavage of ethers to alcohols, to catalyze esterification reactions, and in the nitration and sulfonation of aromatic compounds. Many olefin polymerization reactions use  $\text{BF}_3$  as an initiator, in conjunction with a proton donor, such as water. Also  $\text{BF}_3$  is used to catalyze the isomerization of alkenes and alkanes and in petroleum cracking and desulfurization. Amine complexes of  $\text{BF}_3$  are used as epoxy curing agents.

**Boron Trichloride.** One of the most important uses of  $\text{BCl}_3$  is in the preparation of boron fibers. Typically an electrically heated tungsten filament is passed through a chamber containing  $\text{BCl}_3$  and hydrogen. The  $\text{BCl}_3$  is reduced, and boron is deposited on the filament, producing a stiff, strong boron fiber.

Boron trichloride, like the trifluoride, has been used as a Lewis acid catalyst in organic synthesis in the polymerization of olefins and phosphazines, as well as in catalysis of other organic reactions. Boron trichloride is also used in plasma etching of aluminum and silicon, in semiconductor manufacturing, and as a source of boron for chemical vapor deposition. Steel is boronized by contacting it with a reactive mixture of hydrogen, hydrocarbons, and  $\text{BCl}_3$  at high temperatures.

**Boron Tribromide.** The primary use of boron tribromide is as an initiator for the polymerization of olefins and as a catalyst in other organic reactions. It is also used in the electronics industry as a source of bromine for ion implantation in semiconductors, and for plasma etching in semiconductor device manufacturing.

**Boron Triiodide.** There are no important commercial uses for boron triiodide.

#### 49.2.7 Pollution Control, Toxicology, and Occupational Health

Boron halides are not major pollution sources. Fluoride, from the hydrolysis of  $\text{BF}_3$ , can be precipitated from waste water as  $\text{CaF}_2$  by the addition of a calcium salt [85–87].

Aqueous boron (boric acid or borates) can be precipitated by the addition of calcium salts at high pH.

Boron halides are quite toxic and contact with skin or eyes should be avoided. A TLV ceiling limit of 1.0 ppm,  $3 \text{ mg/m}^3$  (TWA), has been set for  $\text{BF}_3$  by the ACGIH. The MAK values are the same. For  $\text{BBr}_3$ , the adopted TLVs are 1 ppm,  $10 \text{ mg/m}^3$  (TWA); 3 ppm,  $30 \text{ mg/m}^3$  (STEL). The LCs in air for  $\text{BF}_3$  and  $\text{BCl}_3$  in male rats (1 h exposure) are 387 and 2.54 ppm, respectively [88]. These compounds are not known to be carcinogenic.

#### 49.2.8 Fluoroboric Acid and Fluoroborates

##### 49.2.8.1 Physical and Chemical Properties

In the older literature and in some commercial usage,  $\text{HBF}_4$  and its salts are referred to as fluoboric acid and fluoborates. Nomenclature based on fluoroboric and fluoroborates has now become generally accepted in the literature and is used throughout this chapter [93].

The fluoroborate anion,  $\text{BF}_4^-$ , is essentially the adduct of  $\text{BF}_3$  and  $\text{F}^-$ . The ion is tetrahedral, with B–F bond lengths of about 0.140–0.145 nm compared to a B–F bond length of 0.129 nm in  $\text{BF}_3$ .

The fluoroborate anion hydrolyzes in water in a stepwise manner to give first hydroxyfluoroborates, then boric acid:

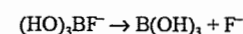
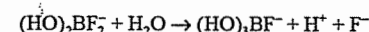
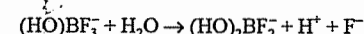
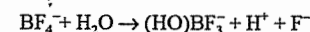

Concentrated solutions of alkali-metal fluoroborates are stable toward hydrolysis; the anion is more easily hydrolyzed in solutions of transition-metal fluoroborates. Concentrated aqueous solutions of fluoroboric acid, tetrafluoroboric acid,  $\text{HBF}_4$ , can be made, but  $\text{HBF}_4$  has not been isolated. Solvated species have been crystallized, including  $\text{H}_3\text{O}^+ \cdot \text{BF}_4^-$ .

$H_2O_2 \cdot BF_4$  and  $[H(CH_2OH)_2] \cdot BF_4$  [94]. The term fluoroboric acid, as used commercially, always refers to an aqueous solution of  $HF_4^-$ .

Many transition-metal fluoroborates are quite soluble in water. Alkali-metal salts are less soluble. Ammonium, sodium, and potassium fluoroborate crystallize as anhydrous salts. Transition-metal salts all crystallize with various degrees of hydration. Many metal fluoroborates are also soluble in methanol and ethanol. Silver and copper(II) fluoroborate are soluble in diethyl ether and aromatic solvents.

Solid fluoroborate salts decompose upon heating, evolving  $BF_3$ . The heat of dissociation increases with cation size for the alkali-metal fluoroborates [95]. The reaction has been used as a convenient source of  $BF_3$  for laboratory applications:

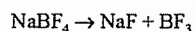

#### 49.2.8.2 Production

Fluoroboric acid is usually made by the reaction of hydrofluoric acid and boric acid in water:

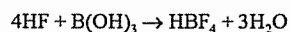

The reaction is exothermic.

Most of the commonly used fluoroborate salts can be prepared by reacting metal oxides, hydroxides, or carbonates with fluoroboric acid.

Ammonium fluoroborate can be made from ammonia and fluoroboric acid. Fluoroborate salts can also be prepared by the reaction of  $BF_3$  with a metal fluoride in a nonaqueous, inert solvent, such as  $HF$ ,  $BrF_3$ , or  $SO_2$ .

#### 49.2.8.3 Quality Specifications, Chemical Analysis

Fluoroboric acid is available from Harshaw/Filtrol in two grades, Electropure and Fluopure, a lower purity material. Specifications for Electropure fluoroboric acid are given in Table 49.4.

**Table 49.4:** Specifications for Harshaw/Filtrol Electro-pure fluoroboric acid.

| Component | Specification | Typical average |
|-----------|---------------|-----------------|
| $HF_4^-$  | 48–50%        | 48.5%           |
| $H_3BO_3$ | 0.5–1.5%      | 0.75%           |
| Fe        | 10 ppm max.   | 4 ppm           |
| Cu        | 1 ppm max.    | < 1 ppm         |
| Pb        | 1 ppm max.    | < 1 ppm         |
| Zn        | 1 ppm max.    | < 1 ppm         |
| Cl        | 3 ppm max.    | < 3 ppm         |
| $SO_4$    | 50 ppm max.   | < 50 ppm        |
| Ni        | 2 ppm max.    | < 1 ppm         |

Solid alkali-metal fluoroborates may contain some hydroxyfluoroborates and boric acid as contaminants. Metal fluoroborate solutions may contain free boric acid or fluoroboric acid as well as trace amounts of metallic impurities.

Fluoroboric acid can be analyzed by hydrolysis, followed by precipitation of fluoride with calcium and titration for the borate. Metal fluoroborates have been analyzed by electrolytic reduction followed by mannitol titration for boric acid [96]. A  $BF_4^-$  ion selective electrode is available from Orion. The tetrafluoroborate ion can also be analyzed by ion chromatography [97, 98].

#### 49.2.8.4 Sources, Handling, and Transportation

Fluoroboric acid is available from Allied Corp., Harshaw/Filtrol, C.P. Chemicals, Fidelity Chemicals, Harstan, and Ozark-Mahoning. A variety of fluoroborate salts is produced by C.P. Chemicals, Harstan, Allied, Harshaw/Filtrol, and Fidelity Chemicals. Transition-metal fluoroborates are commonly sold as aqueous solutions. They may contain a slight excess of boric acid, added as a stabilizer. Information on commercial fluoroborates is given in Table 49.5.

Fluoroboric acid and solutions of fluoroborates are corrosive and are shipped in plastic drums or polyethylene pails. Glass vessels should not be used for containing these solutions.

**Table 49.5:** Commercial fluoroborates.

| Compound                      | Formula      | Commercial form   |
|-------------------------------|--------------|-------------------|
| Fluoroboric acid              | $HF_4^-$     | 49% solution      |
| <i>Alkali-metal salts</i>     |              |                   |
| Ammonium                      | $NH_4BF_4$   | crystalline solid |
| Potassium                     | $KBF_4$      | crystalline solid |
| Sodium                        | $NaBF_4$     | solid             |
| <i>Transition-metal salts</i> |              |                   |
| Antimony(III)                 | $Sb(BF_4)_3$ | solution          |
| Cadmium(II)                   | $Cd(BF_4)_2$ | 50% solution      |
| Cobalt(II)                    | $Co(BF_4)_2$ | solid             |
| Copper(II)                    | $Cu(BF_4)_2$ | 45% solution      |
| Indium(III)                   | $In(BF_4)_3$ | solution          |
| Iron(II)                      | $Fe(BF_4)_2$ | 41% solution      |
| Lead(II)                      | $Pb(BF_4)_2$ | 51% solution      |
| Nickel(II)                    | $Ni(BF_4)_2$ | 45% solution      |
| Silver(I)                     | $AgBF_4$     | powder            |
| Tin(II)                       | $Sn(BF_4)_2$ | 50% solution      |
| Zinc(II)                      | $Zn(BF_4)_2$ | 40% solution      |

Solutions of fluoroboric acid and fluoroborates are classified as corrosive materials for shipping.

#### 49.2.8.5 Uses

The primary use of fluoroboric acid is in the preparation of other fluoroborate salts. Fluoroboric acid is also used in electroplating and in dipping solutions for surface treating of aluminum. It has been recommended as a pickling agent for hot rolled steel [99], and has been patented for use as an etchant for silicon and glass in the electronics industry [100, 101].

Molten alkali-metal and ammonium fluoroborates are good solvents for metal oxides and are commonly used in fluxes for soldering and brazing.

A mixture of  $LiF$  and  $NaBF_4$  has been studied as a nuclear reactor coolant [102] and as a solvent for fissionable materials. Mixtures of  $NH_4BF_4$  with nitro compounds are useful as explosives [103].

Alkali metal fluoroborates and fluoroboric acid have also been used as catalysts in organic synthesis and in polymerization reactions.

Lithium fluoroborate is used as an electrolyte in lithium-sulfur batteries.

The fluoroborate anion is similar to perchlorate,  $ClO_4^-$ , in its size, shape, and lack of

ability to form coordinate bonds with transition metals. Fluoroborates are often used in transition metal chemistry where a noncoordinating anion is required.

The primary use of transition metal fluoroborates is in electroplating. The fluoroborate ion is electrochemically inert and solutions of fluoroborates are highly conductive. Metals plated from fluoroborate solutions include cadmium, copper, indium, iron, lead, nickel, silver, tin, and zinc.

#### 49.2.8.6 Pollution Control, Toxicology

Aqueous solutions of fluoroborates can be hydrolyzed and treated with calcium compounds to precipitate calcium fluoride for pollution control [104–106]. Reverse osmosis has also been used to purify waste streams containing potassium fluoroborate [107].

Protective equipment used with hydrofluoric acid should also be used when handling solutions of fluoroboric acid or fluoroborates.

Little information is available in the literature on the toxicity of fluoroborates. Fluoroborate given intravenously to rats depressed levels of L-thyroxine [108], and ammonium fluoroborate was shown to be nontoxic to fresh water minnows at concentrations less than 600 mg/L [109].

#### 49.2.9 Boron Subhalides

All of the compounds,  $B_2X_4$ , where X is F, Cl, Br, or I, are known. The tetrafluoride is the most stable, but all four compounds decompose at room temperature to  $BX_3$  and other boron halides. The compounds are Lewis diacids and form 1:2 complexes with amines and other Lewis bases. Boron tetrachloride, which is the most commonly used of these tetrahalides, can be prepared by reduction of  $BCl_3$  in an electrical discharge apparatus. The most important use of  $B_2X_4$  compounds is in dimerization reactions, i.e., the addition of  $B_2X_4$  to unsaturated organic molecules. These reactions are analogous to hydroboration reactions with diborane. Some of the decomposition

products of  $B_2Cl_4$  have been characterized. They include  $B_4Cl_4$ ,  $B_8Cl_8$ , and  $B_9Cl_9$ .

## 49.3 Boron Sulfide

### 49.3.1 Physical and Chemical Properties

Boron sulfide,  $B_2S_3$ , is a colorless compound normally obtained as an amorphous glass. It is extremely difficult to purify and often contains traces of silicon (from glass vessels), oxygen, or sulfur, which may impart a yellow color to the material [110]. The amorphous form does not have a well-defined melting point but begins to sublime at about 300 °C. Some of the physical properties are given in Table 49.6.

Table 49.6: Physical properties of  $B_2S_3$ .

|                                    |                       |
|------------------------------------|-----------------------|
| mp (crystalline form), °C          | 563 [111]             |
| Flow point (amorphous form), °C    | 310 [110]             |
| bp, °C                             | ≈ 300, sublimes [110] |
| Density $\rho$ , g/cm <sup>3</sup> | 1.92 [112]            |
| B-S bond energy, kJ/mol            | 360 [113]             |
| Heat of fusion, kJ/mol             | 150 [110]             |
| Heat of vaporization, kJ/mol       | 252 [114]             |
| Average B-S bond length, nm        | 0.1808 [112]          |

An X-ray analysis of crystalline  $B_2S_3$  indicates it is composed of  $(BS)_3$  and  $(BS)_2$  rings linked through bridging sulfur atoms in a two-dimensional lattice [112].

Boron sulfide reacts with a variety of protonic reagents [115]:

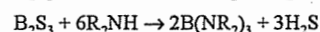
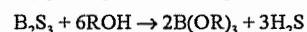
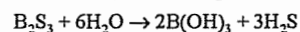

The reaction with water is quite violent.

Boron sulfide inflames in chlorine, and is oxidized at high temperature by carbon dioxide or by oxygen [115]. At high temperature it also readily attacks quartz and silicate glass [110]. Boron sulfide reacts with sulfur to give  $B_8S_{16}$ , a planar molecule [116]. A variety of other higher molecular mass boron sulfides is also known [117].

Boron sulfide can also act as a sulfidizing agent [118] and can be used to replace a terminal oxygen atom with a terminal sulfur atom in

both organic and inorganic systems [119, 120].

### 49.3.2 Production

Boron sulfide is difficult to prepare in a pure form. The reaction of boron hydrides or metal borides with sulfur or sulfur compounds yields impure  $B_2S_3$  [110]. Higher purity product is obtained by the reaction of amorphous boron with  $H_2S$  or sulfur. Other preparative reactions that have been reported are:

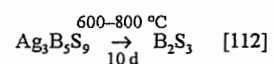
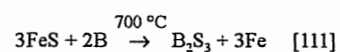

The recommended route for the synthesis of pure  $B_2S_3$  is the decomposition of  $(XBS)_3$ , where X is Cl, Br, or I [110, 115]:

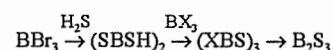

### 49.3.3 Uses

Boron sulfide has been used in organic synthesis to reduce sulfoxides to thiols [121], and to convert ketones to thioketones [119, 122]. Recently it was found that the sulfide glasses,  $M_2S-B_2S_3$ , where M is Li or Na, have electrical conductivities  $10^3$  times greater than the corresponding oxide glasses [123]. Electrically conducting boron sulfide glasses have also been made incorporating LiI [124] and other glass-forming sulfides [125, 126]. These glasses have potential as electrolytes in batteries or fuel cells.

Boron sulfide is available in research quantities from the Alfa-Ventron Division of Morton-Thiokol (USA).

## 49.4 Boranes

### 49.4.1 Diborane and Higher Boranes

**Introduction.** ALFRED STOCK and co-workers began working on the hydrides of boron in 1912 [127]. From then until 1936, he discov-

ered a series of boron hydrides of the composition  $B_nH_{n+4}$  and  $B_nH_{n+6}$ , which he named boranes.

Research on boron hydrides was started in the United States by H. I. SCHLESINGER, who with A. BURG published a new preparation of diborane in 1931 [128]. Impetus was added by government sponsorship of various military programs to develop high-energy fuels for rockets and aircraft during World War II. Boron fuels (alkyl penta- and decaboranes) created great interest because they possessed much higher heats of combustion than conventional hydrocarbon fuels. Large quantities of boron fuels were manufactured under projects HEF (Olin Matheson Chemical Corp.) and ZIP (Callery Chemical Co.).

Attention has been expanded to other chemical properties of the boranes since 1956, when H. C. BROWN discovered hydroboration procedures [129] (1979 Nobel Prize). His work has opened new avenues of research, one of which was to obtain chiral and optically specific compounds required in biological activity.

Progress in borane research was thwarted by inconclusive theories of structure and reactivity until the second half of the century, when W. LIPSCOMB and co-workers defined the structural and theoretical aspects of the boron hydrides through X-ray diffraction studies [130] (1976 Nobel Prize). This breakthrough in borane chemistry gave new impetus to boron research and to the discovery of the most thermodynamically and kinetically stable class of boranes, the polyhedral anions, carbaboranes, and metallocboranes.

Collectively, boranes are compounds of very complex structure with  $B-H^{\mu}-B$  and (open or closed structured)  $B-B^{\mu}-B$  tricentered bonds, with  $H^{\mu}$  equal to linking hydrogen atoms. Explanation of structures and unusual bonding of these compounds has furthered the theory of chemical bonding [131]. Nomenclature of these compounds has been confusing, however, and recommendations to clarify their structures have been made by IUPAC and ACS [132].

Table 49.7: Physical properties of boranes.

| Formula        | mp, °C | bp, °C<br>(101.3 kPa) | $\Delta H^{\circ}$ fusion,<br>kJ/mol |
|----------------|--------|-----------------------|--------------------------------------|
| $B_2H_6$       | -164.9 | -92.6                 | 35.5                                 |
| $B_4H_{10}$    | -120   | 18                    | 66.1                                 |
| $B_5H_9$       | -46.6  | 48                    | 73.2                                 |
| $B_{10}H_{14}$ | 99.7   | 213                   | 31.5                                 |

### 49.4.1.1 Physical and Chemical Properties

The lower boranes are very reactive to oxygen and moisture. Diborane(6),  $B_2H_6$ , and air mixtures containing 75–98% diborane detonate in air when sparked, and concentrations over 0.5 vol% can lead to explosions in air or oxygen even without an ignition source. For recent investigations of oxidation see [133–135]. Pentaborane(9),  $B_5H_9$ , a volatile liquid, reacts readily with air and moisture. Solid decaborane(14),  $B_{10}H_{14}$ , should be handled in an inert atmosphere; exposure should be avoided because of the compound's toxicity (see Table 49.8). Solutions of  $B_{10}H_{14}$  and carbon tetrachloride are explosive and more shock sensitive than nitroglycerine [136]. Some physical properties of the most commercially available boranes are given in Table 49.7.

As a Lewis acid, the borane(3),  $BH_3$ , group complexes with Lewis bases, analogous to coordinate compounds of the Werner type; the ligands  $NH_3$ ,  $NH_2R$ , and  $NR_3$  are common to the two cases [137]. The Lewis acid  $BH_3$  combines with another borane (Lewis acid) to give the relatively stable borane(6); hence borane groups may be considered as operational "electron-deficient" bases as well as Lewis acids: How the nature of the base or nucleophile affects the cleavage of diborane is controversial and has been discussed [138]. With neutral bases the two modes of cleavage, symmetric or unsymmetric, may occur to give molecular or ionic fragments as shown in Figure 49.1. Generally with large bases or weaker donor atoms symmetric cleavage occurs. Base displacement reactions readily occur and the relative stability of the complexes is:

Group V:  $P > N$

Group VI:  $S > O$

Group V > Group VI

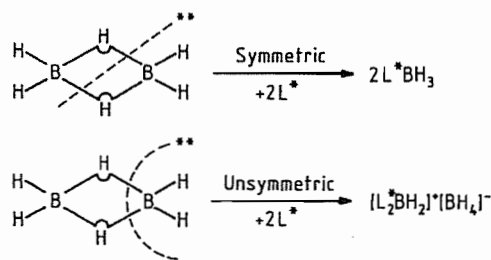

Figure 49.1: Cleavage of diborane. \* L is any ligand. \*\* Modes of cleavage.

Lewis bases react with decaborane, without deprotonation, evolving hydrogen with the ligands coordinating at the 6,9 position. This species,  $B_{10}H_{12}L_2$ , is a key intermediate in the synthesis of the very stable and useful *closo*-boranes,  $[B_{10}H_{10}]^{2-}$  and carbaboranes (where carbon is inserted in the 1,2 position of the polyhedron, i.e., 1,2- $C_2B_{10}H_{12}$ ).

Bridge hydrogens of the boranes are acidic as demonstrated by titration of  $B_{10}H_{14}$  and by deuterium exchange [139, 140]. Abstraction of a proton forms hypopolyborate anions, such as  $B_5H_8$ . They are useful intermediates in the formation of higher boranes, heteroboranes, and metalboranes. These anions, containing a B-B edge bond, can be reacted with diborane to expand the polyhedron [141].

#### 49.4.1.2 Production

*Diborane(6)* is available from Callery Chemical Co., Callery, Pennsylvania (USA). The method preferred for the commercial preparation is the addition of boron trifluoride to a stirred solution of sodium borohydride in diethylene glycol dimethyl ether (diglyme):

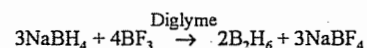

Currently, diborane is shipped either as a compressed gas (ambient) or as a liquid (cylinder over packaged with dry ice). It is packaged as a hazardous material regulated by the DOT [142].

*Tetraborane(10)*,  $B_4H_{10}$ , can be obtained by the action of acid on borides [143–145]. It has been prepared from the decomposition of diborane at 120–180 °C [146] and under pressure

[147]. Tetraborane can also be prepared from the reaction of acid on commercially available  $B^3H_8^-$  salts, e.g.,  $NaB_3H_8$ .

*Pentaborane* is obtained by passing diborane through a hot tube. Careful control of temperature, pressure, and flow are required to obtain good yields and avoid further pyrolysis to higher hydrides.

*Decaborane* can be produced by several procedures, none of which give high yields; all require extensive preparatory time or equipment. It is best produced by the pyrolysis of diborane between 120–240 °C. The solids thus produced are removed from the reactor by dissolution and further purified by sublimation.

#### 49.4.1.3 Uses

Most of the boranes are highly reactive. This property makes them useful and important chemicals, but also necessitates special care in their application.

Diborane serves as a strong but selective reducing agent in organic chemistry. It is an electrophilic reagent and reacts markedly different from the nucleophilic alkali-metal boron and aluminum hydrides. The rates of reduction with diborane were found to decrease in the order: carboxylic acids > olefins > ketones > nitriles > epoxides > esters > acid chlorides [148]. Reductions of several other organic substrates have been studied, for example, oximes [149], perfluorinated olefins [150], diene polymers [151], and organic acid amides [152].

*Hydroboration*, the addition of diborane or borane to olefins, has found great significance in preparative chemistry [129]. Hydroboration is applicable to multiple bonds between C-C, C-O, C-N, N-N, N-O. Diborane catalyzed by the presence of an ether adds, in an anti-Markownikoff mode, virtually quantitatively to the carbon-carbon double bond of olefins, forming an alkyl borane.

Other important derivatives of diborane are Lewis base adducts, carbonyl adducts, and oxygen-containing products. Further areas of application for diborane are the doping of

semiconductor silicon and germanium. Diborane is readily decomposed at high temperature (600–700 °C) [153] to give fine-powder, high-purity elemental boron. Copyrolysis of diborane with hydrocarbons yields boron carbide, and with  $NH_3$  yields boron nitride. These materials, deposited on metal substrates as thin, hard layers, are used in ceramics, tools, and wear-resistant parts. Boron fibers are formed from the decomposition of diborane on substrates and used for light-weight structural components.

The large cross-sectional area of the  $^{10}B$  isotope for neutron capture makes these compounds especially useful in nuclear applications. Borane is also supplied as stable liquid adducts  $(CH_3)_2S \cdot BH_3$  (Callery Chemical Co., Aldrich Chemical Co.), and as a 1 M solution in tetrahydrofuran (THF) (Aldrich Chemical Co., Ventron Div. of Morton-Thiokol Inc.).

#### 49.4.2 Borohydrides

Of the borohydrides or hydroboron ions, the most common and most completely studied is the tetrahydromonoborate(1-). The oxidation state of the central atom in the higher hydroboron ions is fractional in ions containing several boron atoms and the charge is listed as a suffix in parentheses [154]. Generally, the borohydrides are highly polarizable [155] and the bonding may vary from essentially ionic to essentially covalent.

All of the alkali-metal tetrahydroborates have been prepared and are white crystalline solids with markedly different solubilities. Sodium tetrahydroborate(1-),  $NaBH_4$ , is stable in dry air, reacting slowly with moisture. Hydrolysis is catalyzed by acid, but can be terminated with sufficient sodium hydroxide [156]. Salts of the ions  $B_3H_8^-$ ,  $B_{11}H_{14}^-$ ,  $B_{10}H_{10}^{2-}$  and  $B_{12}H_{12}^{2-}$  are all white crystalline solids. The latter two salts are extremely stable thermally, especially their halo derivatives  $B_{10}X_{10}^{2-}$ ,  $B_{12}X_{12}^{2-}$ .

**Production.** Sodium tetrahydroborate is made by the addition of methyl borate to hydrogenated sodium in mineral oil [157, 158]:

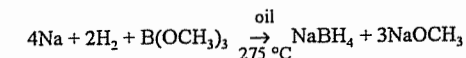

Separation of the sodium methoxide from  $NaBH_4$  was accomplished by such methods as extraction with amines [159], and extraction with water followed by a counterextraction with a solvent, such as 2-aminopropane [160]. Sodium borohydride is produced commercially by Ventron Div., Morton-Thiokol (USA) [161].

A simple preparation for  $B_3H_8^-$ , adaptable to large scale, involves the addition of  $B_2H_6$  to  $NaBH_4$  in diglyme at 100 °C [162]. Further addition of  $B_2H_6$  to the  $B_3H_8^-$  at higher temperature yields  $B_{12}H_{12}^{2-}$  [163].

**Uses.** A concentrated aqueous solution of  $NaBH_4$  stabilized by NaOH is used to reduce hydrogen sulfite to dithionite in the bleaching of ground wood pulp [164]. Also,  $NaBH_4$  has extensive and important use as a reducing agent in organic synthesis. Other hydroborates can be obtained by reaction with  $NaBH_4$  to give different reductive capabilities (e.g.,  $NaBH_3CN$ ) [165].

Additional applications are extensive, e.g., electroless plating [166], blowing agent for cellular plastics [167], removal of heavy metals from waste streams [168], polymerization catalyst [169], and hydrogen source for fuel cells [170]. The  $B_3H_8^-$ ,  $B_{10}H_{10}^{2-}$ , and  $B_{12}H_{12}^{2-}$  may also find use in the latter application. The quaternary ammonium salt of  $B_3H_8^-$  is used as a fogging agent in photographic film [171]. Chloro derivatives of  $B_{10}H_{10}^{2-}$  and  $B_{12}H_{12}^{2-}$  lithium salts have been used as battery electrolytes [172];  $B_{12}H_{11}SH^{2-}$  was useful in a study of neutron-capture therapy in brain tumors [173].

#### 49.5 Toxicology and Occupational Health

The toxicology of boron compounds has been reviewed recently [174]. Experimental animal toxicity data, cases of human exposures, industrial hygiene, and medical treatments are discussed. There are also other

readily accessible sources of information [175, 176].

Diborane(6) is primarily a pulmonary irritant [177]; TLVs and MAKs are given in Table 49.8 [178]. Overexposure causes respiratory tract injury, and secondary infections may follow [180]. Prolonged exposure to low concentrations causes headaches and other central nervous system (CNS) effects [181]. Diborane is a flammable gas and must be handled in a closed system.

Pentaborane(9) and decaborane(14) affect the CNS and can have effects that may be delayed for up to 48 h [181]. TLVs have been set (Table 49.8) [178]. Pentaborane(9) is a liquid which should be treated as pyrophoric and must be handled in a closed system. Decaborane(14) is a solid but has sufficient vapor pressure at room temperature to make it a hazard by inhalation, as well as by the dermal and oral routes [182].

Animal toxicity testing of amine boranes has shown that they also affect the CNS [183]; however, no TLVs or MAKs have been set for them. Toxicity is affected by the number and kind of substituents and varies from compounds that are highly toxic to those with low toxicity [183, 184].

The few toxicity studies on borohydrides show that they are corrosive to the skin and eyes [185]. When ingested, sodium borohydride produced death from gas embolism in animals.

The lower trialkylboranes have some toxicity to small rodents at nonpyrophoric concentrations in air [174, 186].

**Table 49.8:** Maximum concentrations in the work environment [178, 179].

|                | TWA   |                   | STEL  |                   | MAK   |                   |
|----------------|-------|-------------------|-------|-------------------|-------|-------------------|
|                | ppm   | mg/m <sup>3</sup> | ppm   | mg/m <sup>3</sup> | ppm   | mg/m <sup>3</sup> |
| Diborane(6)    | 0.1   | 0.1               | —     | —                 | 0.1   | 0.1               |
| Pentaborane(9) | 0.005 | 0.01              | 0.015 | 0.03              | 0.005 | 0.01              |
| Decaborane(14) | 0.05  | 0.3               | 0.15  | 0.9               | 0.05  | 0.3               |

Toxicity of carbaboranes depends mainly on the nature of the substituents [174, 187].

## 49.6 Metal Borides

Boron combines with a large number of metals and semimetals to form binary or higher solid compounds, the so-called borides. Most binary borides, especially those formed from transition metals having high melting points, are metallic high-temperature materials that can be grouped with the carbides, nitrides, and silicides as refractory hard metals [188]. Although a great number of metal borides were prepared by MOISSAN around the turn of the century [194], they have not established themselves in modern technology to the same extent as the refractory metal carbides. Thus it has not been possible to develop metal boride materials that combine the extreme hardness of refractory borides with toughness in analogy with cemented tungsten carbide.

Nevertheless, metal borides have some unique properties and are used in some specialized fields of modern industry, especially when the requirements cannot be met by other materials. More information about metal borides is available in [190, 191, 195–203].

### 49.6.1 Properties

Metal borides are unique in the number of stoichiometries; compositions corresponding to at least 24 M:B ratios between 5:1 and 1:66 are known. However, the most common are the monoborides, MB; diborides, MB<sub>2</sub>; tetraborides, MB<sub>4</sub>; hexaborides, MB<sub>6</sub>; dodecaborides, MB<sub>12</sub>; and hectoborides, MB<sub>66</sub>. The binary compounds of boron are given in the form of a periodic table in Table 49.9. As can be seen, many metal–boron systems contain three or more intermediate phases.

A classification of borides was first given by KIESSLING [204] on the basis of boron structural elements typical for various M:B ratios.

**Table 49.9:** Binary compounds of boron.

| Main group elements            |                                   |                   |                                   |                                 |                                |  |                                |
|--------------------------------|-----------------------------------|-------------------|-----------------------------------|---------------------------------|--------------------------------|--|--------------------------------|
| H <sub>3</sub> B <sup>a</sup>  |                                   |                   |                                   |                                 |                                |  |                                |
| Li <sub>3</sub> B <sub>4</sub> | Be <sub>2</sub> B                 |                   | (B <sub>12</sub> C)               | BN                              | BO                             |  | BF <sub>3</sub>                |
| LiB <sub>6</sub>               | Be <sub>3</sub> B                 |                   | (B <sub>13</sub> C <sub>2</sub> ) |                                 | B <sub>2</sub> O <sub>2</sub>  |  |                                |
| LiB <sub>10</sub>              | BeB <sub>2</sub>                  |                   | B <sub>12</sub> C <sub>3</sub>    |                                 | B <sub>2</sub> O <sub>3</sub>  |  |                                |
|                                | BeB <sub>6</sub>                  |                   |                                   |                                 | BO <sub>2</sub>                |  |                                |
|                                | (BeB <sub>12</sub> ) <sup>b</sup> |                   |                                   |                                 | BO <sub>3</sub>                |  |                                |
|                                |                                   |                   |                                   |                                 | B <sub>12</sub> O <sub>2</sub> |  |                                |
| NaB <sub>6</sub>               | MgB <sub>2</sub>                  | AlB <sub>2</sub>  | (B <sub>14</sub> Si)              | B <sub>12</sub> P <sub>2</sub>  | B <sub>12</sub> S <sub>2</sub> |  | B <sub>2</sub> Cl <sub>4</sub> |
| NaB <sub>15</sub>              | MgB <sub>4</sub>                  | AlB <sub>12</sub> | B <sub>12</sub> Si <sub>2</sub>   | B <sub>13</sub> P <sub>2</sub>  | BS                             |  | BCl <sub>3</sub>               |
|                                | (MgB <sub>6</sub> )               |                   | B <sub>12</sub> Si <sub>3</sub>   | BP                              | B <sub>2</sub> S <sub>2</sub>  |  |                                |
|                                | MgB <sub>7</sub>                  |                   |                                   |                                 | B <sub>2</sub> S <sub>3</sub>  |  |                                |
|                                | (MgB <sub>12</sub> )              |                   |                                   |                                 | BS <sub>2</sub>                |  |                                |
|                                |                                   |                   |                                   |                                 | B <sub>2</sub> S <sub>5</sub>  |  |                                |
| KB <sub>6</sub>                | CaB <sub>4</sub>                  |                   |                                   | B <sub>12</sub> As <sub>2</sub> | BSe                            |  | BBr <sub>3</sub>               |
|                                | CaB <sub>6</sub>                  |                   |                                   | B <sub>13</sub> As <sub>2</sub> | B <sub>2</sub> Se <sub>3</sub> |  |                                |
|                                |                                   |                   |                                   | BA <sub>5</sub>                 | BSe <sub>2</sub>               |  |                                |
| (RbB <sub>6</sub> )            | SrB <sub>6</sub>                  |                   |                                   |                                 |                                |  | BI <sub>3</sub>                |
| (CsB <sub>6</sub> )            | BaB <sub>6</sub>                  |                   |                                   |                                 |                                |  |                                |

<sup>a</sup>And higher boranes.

<sup>b</sup>Parentheses around a compound indicate that the existence of the compound has not been confirmed.

### Transition metals

|                   |                   |                                |                                  |                                |                                 |                                |                                |                     |
|-------------------|-------------------|--------------------------------|----------------------------------|--------------------------------|---------------------------------|--------------------------------|--------------------------------|---------------------|
| ScB <sub>2</sub>  | TiB               | V <sub>3</sub> B <sub>2</sub>  | Cr <sub>2</sub> B                | Mn <sub>2</sub> B              | Fe <sub>2</sub> B               | Co <sub>3</sub> B              | Ni <sub>3</sub> B              |                     |
| ScB <sub>12</sub> | TiB <sub>2</sub>  | VB                             | Cr <sub>3</sub> B <sub>3</sub>   | MnB                            | FeB                             | Co <sub>2</sub> B              | Ni <sub>2</sub> B              |                     |
|                   |                   | V <sub>3</sub> B <sub>6</sub>  | CrB                              | Mn <sub>3</sub> B <sub>4</sub> |                                 | CoB                            | Ni <sub>4</sub> B <sub>3</sub> |                     |
|                   |                   | V <sub>3</sub> B <sub>4</sub>  | Cr <sub>3</sub> B <sub>4</sub>   | MnB <sub>2</sub>               |                                 |                                | NiB                            |                     |
|                   |                   | V <sub>2</sub> B <sub>3</sub>  | CrB <sub>2</sub>                 | MnB <sub>4</sub>               |                                 |                                |                                |                     |
|                   |                   | VB <sub>2</sub>                | CrB <sub>4</sub>                 |                                |                                 |                                |                                |                     |
| YB <sub>2</sub>   | ZrB <sub>2</sub>  | Nb <sub>3</sub> B <sub>2</sub> | Mo <sub>2</sub> B                | Tc <sub>3</sub> B              | Ru <sub>7</sub> B <sub>3</sub>  | Rh <sub>7</sub> B <sub>3</sub> | Pd <sub>4</sub> B              | (AgB <sub>2</sub> ) |
| YB <sub>4</sub>   | ZrB <sub>12</sub> | NbB                            | MoB                              | Tc <sub>7</sub> B <sub>3</sub> | Ru <sub>11</sub> B <sub>8</sub> | Rh <sub>4</sub> B <sub>4</sub> | Pd <sub>3</sub> B              |                     |
| YB <sub>6</sub>   |                   | Nb <sub>3</sub> B <sub>4</sub> | MoB <sub>2</sub>                 | TcB <sub>2</sub>               | RuB                             | RhB                            | Pd <sub>3</sub> B <sub>2</sub> |                     |
| YB <sub>12</sub>  |                   | NbB <sub>2</sub>               | MoB <sub>2,3</sub>               |                                | Ru <sub>2</sub> B <sub>3</sub>  |                                | Pd <sub>2</sub> B              |                     |
| YB <sub>66</sub>  |                   |                                | Mo <sub>1-x</sub> B <sub>3</sub> |                                | RuB <sub>2</sub>                |                                |                                |                     |
| *                 | HfB               | Ta <sub>2</sub> B              | W <sub>2</sub> B                 | Re <sub>3</sub> B              | OsB                             | IrB <sub>0.9</sub>             | Pt <sub>4</sub> B              | (AuB <sub>2</sub> ) |
|                   | HfB <sub>2</sub>  | Ta <sub>3</sub> B <sub>2</sub> | WB                               | Re <sub>7</sub> B <sub>3</sub> | Os <sub>2</sub> B <sub>3</sub>  | IrB <sub>1.1</sub>             | Pt <sub>2</sub> B              |                     |
|                   |                   | TaB                            | WB <sub>2</sub>                  | ReB <sub>2</sub>               | OsB <sub>2</sub>                | IrB <sub>1.3</sub>             | PtB <sub>0.7</sub>             |                     |
|                   |                   | Ta <sub>3</sub> B <sub>4</sub> | W <sub>2</sub> B <sub>5</sub>    |                                |                                 |                                |                                |                     |
|                   |                   | TaB <sub>2</sub>               | W <sub>1-x</sub> B <sub>3</sub>  |                                |                                 |                                |                                |                     |
| **                |                   |                                |                                  |                                |                                 |                                |                                |                     |

### Lanthanides and actinides

|    |                   |                  |                                |                                  |                      |                                |                  |                                |                   |                   |                   |                   |                   |                   |                   |
|----|-------------------|------------------|--------------------------------|----------------------------------|----------------------|--------------------------------|------------------|--------------------------------|-------------------|-------------------|-------------------|-------------------|-------------------|-------------------|-------------------|
| *  | LaB <sub>4</sub>  | CeB <sub>4</sub> | Pr <sub>3</sub> B <sub>5</sub> | Nd <sub>4</sub> B <sub>3</sub>   | PmB <sub>4</sub>     | Sm <sub>2</sub> B <sub>5</sub> | EuB <sub>6</sub> | Gd <sub>4</sub> B <sub>5</sub> | TbB <sub>2</sub>  | DyB <sub>2</sub>  | HoB <sub>2</sub>  | ErB <sub>2</sub>  | TmB <sub>2</sub>  | YbB <sub>2</sub>  | LuB <sub>2</sub>  |
|    | LaB <sub>6</sub>  | CeB <sub>6</sub> | PrB <sub>4</sub>               | Nd <sub>3</sub> B <sub>4</sub>   | PmB <sub>6</sub>     | SmB <sub>4</sub>               |                  | GdB <sub>2</sub>               | TbB <sub>4</sub>  | DyB <sub>4</sub>  | HoB <sub>4</sub>  | ErB <sub>4</sub>  | TmB <sub>4</sub>  | YbB <sub>4</sub>  | LuB <sub>4</sub>  |
|    | LaB <sub>9</sub>  |                  | PrB <sub>6</sub>               | Nd <sub>6</sub> B <sub>6</sub>   |                      | SmB <sub>6</sub>               |                  | GdB <sub>4</sub>               | TbB <sub>6</sub>  | DyB <sub>6</sub>  | HoB <sub>6</sub>  | ErB <sub>12</sub> | TmB <sub>12</sub> | YbB <sub>6</sub>  | LuB <sub>12</sub> |
|    |                   |                  |                                | Nd <sub>66</sub> B <sub>66</sub> |                      | SmB <sub>66</sub>              |                  | GdB <sub>66</sub>              | TbB <sub>12</sub> | DyB <sub>12</sub> | HoB <sub>12</sub> | ErB <sub>66</sub> | TmB <sub>66</sub> | YbB <sub>12</sub> | LuB <sub>66</sub> |
|    |                   |                  |                                |                                  |                      |                                |                  | GdB <sub>66</sub>              | TbB <sub>66</sub> | DyB <sub>66</sub> | HoB <sub>66</sub> |                   |                   | YbB <sub>66</sub> |                   |
| ** | ThB <sub>4</sub>  | UB <sub>2</sub>  | NpB <sub>2</sub>               | PuB <sub>2</sub>                 | AmB <sub>4</sub>     | CmB <sub>4</sub>               |                  |                                |                   |                   |                   |                   |                   |                   |                   |
|    | ThB <sub>6</sub>  | UB <sub>4</sub>  | NpB <sub>4</sub>               | PuB <sub>4</sub>                 | AmB <sub>6</sub>     | CmB <sub>6</sub>               |                  |                                |                   |                   |                   |                   |                   |                   |                   |
|    | ThB <sub>66</sub> | UB <sub>12</sub> | NpB <sub>6</sub>               | PuB <sub>6</sub>                 | (AmB <sub>12</sub> ) | (CmB <sub>12</sub> )           |                  |                                |                   |                   |                   |                   |                   |                   |                   |
|    |                   |                  | NpB <sub>12</sub>              | PuB <sub>12</sub>                | AmB <sub>66</sub>    | CmB <sub>66</sub>              |                  |                                |                   |                   |                   |                   |                   |                   |                   |
|    |                   |                  | BpN <sub>66</sub>              | PuB <sub>66</sub>                |                      |                                |                  |                                |                   |                   |                   |                   |                   |                   |                   |

**Table 49.10:** Physical properties of some refractory borides [191].

| Boride                         | Density $\rho$ ,<br>$10^3 \text{ kg/m}^3$ | Melting<br>point $mp$ , K | Electrical<br>resistivity,<br>$10^{-8} \Omega\text{m}$ | Knoop<br>hardness,<br>load 0.1 kp |
|--------------------------------|---|---------------------------|--|-----------------------------------|
| TiB <sub>2</sub>               | 4.52                                      | 3470                      | 9–15   | 2600                              |
| ZrB <sub>3</sub>               | 6.09                                      | 3520                      | 7–10   | 1830                              |
| ZrB <sub>12</sub>              | 3.61                                      | 2520                      | 60–80  | 2580                              |
| HfB <sub>2</sub>               | 11.2                                      | 3650                      | 10–12  | 2160                              |
| VB <sub>2</sub>                | 5.10                                      | 2670                      | 16–38  | 2110                              |
| NbB <sub>2</sub>               | 7.21                                      | 3270                      | 12–65  | 2130                              |
| TaB <sub>2</sub>               | 12.60                                     | 3370                      | 14–68  | 2500                              |
| CrB <sub>3</sub>               | 5.20                                      | 2170                      | 21–56  | 1100                              |
| Mo <sub>2</sub> B <sub>3</sub> | 7.48                                      | 2370                      | 18–45  | 2180                              |
| W <sub>2</sub> B <sub>3</sub>  | 13.1                                      | 2470                      | 21–56  | 2500                              |
| Fe <sub>2</sub> B              | 7.32                                      | 1663                      | —  | 1800                              |
| FeB                            | 7.15                                      | 1820                      | 30   | 1900                              |
| CoB                            | 7.32                                      | 1535                      | 26   | 2350                              |
| NiB                            | 7.39                                      | 1325                      | 23   | —                                 |
| LaB <sub>6</sub>               | 5.76                                      | 2985                      | 7–15   | 2010                              |
| EuB <sub>6</sub>               | 4.91                                      | 2890                      | 80–170   | 1870                              |
| UB <sub>4</sub>                | 9.38                                      | 2768                      | 30   | 1850                              |
| UB <sub>12</sub>               | 5.65                                      | 2500                      | 22   | 2630                              |
| CaB <sub>6</sub>               | 2.46                                      | 2540                      | 160  | 1650                              |
| SiB <sub>6</sub>               | 2.43                                      | 2140                      | $2 \times 10^5$  | 2140                              |
| B <sub>4</sub> C               | 2.52                                      | 2720                      | $10^5$ – $10^7$  | 3000                              |
| $\beta$ -B                     | 2.35                                      | 2420                      | $10^{12}$  | 2600                              |

With increasing M:B ratio the tendency to form boron–boron bonds increases, and pairs (M<sub>3</sub>B<sub>2</sub>), zigzag chains (MB), branched chains (M<sub>11</sub>B<sub>8</sub>), double chains (M<sub>3</sub>B<sub>4</sub>), plane nets (MB<sub>2</sub>), and finally three-dimensional arrays of boron atoms, including cross-linked nets (MB<sub>4</sub>), interconnected B<sub>6</sub> octahedra (MB<sub>6</sub>), B<sub>12</sub>-cubo-octahedra (MB<sub>12</sub>), and interconnected B<sub>12</sub>-icosahedra (MB<sub>66</sub>) all are found.

The most characteristic properties of the metal borides are their high melting points, extreme hardness, and in many cases high electrical and thermal conductivities, fair corrosion resistance, good wear resistance, and thermal shock resistances superior to those of oxide ceramics. Some physical properties of the most common and typical metal borides are given in Table 49.10. The most stable binary borides at high temperatures are the diborides of titanium, zirconium, and hafnium, each melting above 3000 °C. The melting points of the boron-rich borides MB<sub>*n*</sub>, *n* ≥ 2, are generally higher than those of the parent transition metals. On the other hand, melting points of metal-rich borides are often

as low as those of their parent metals. Most of these borides are paramagnetic. Knoop hardness numbers HK-0.1 usually fall in the range of 1100–2600 for diborides, 1650–2100 for hexaborides, and 2300–2600 for dodeca- and hectoborides [205]; therefore, many borides are harder than WC or  $\alpha$ -Al<sub>2</sub>O<sub>3</sub>, two cutting and grinding materials widely used. Hardness and high melting points reflect the properties of the rigid, three-dimensional boron frameworks.

The electrical characteristics, however, cover the entire spectrum: semiconductors, the MB<sub>66</sub>, MB<sub>6</sub>, and MB<sub>12</sub> phases of Be, Mg, Ca, Eu, Al, and Si; metallic conductors, TiB<sub>2</sub>, ZrB<sub>2</sub>, and the majority of transition-metal borides; superconductors, NbB, YB<sub>6</sub>, and ZrB<sub>12</sub>.

In addition, LaB<sub>6</sub> and other lanthanoid and actinoid borides (YB<sub>6</sub>, ThB<sub>6</sub>, GdB<sub>6</sub>, etc.) belong to the best-known high-temperature electron emitters. Most of these borides are intensively colored: for example, ZrB<sub>12</sub> is pink, GdB<sub>6</sub> is blue, LaB<sub>6</sub> is purple, and ThB<sub>6</sub> is scarlet [191, 205].

The metal borides display resistance to oxidation in air at elevated temperatures, most of them up to 1000 °C, and to attack by molten metals, basic slags, and molten salts. Except for alkali-metal and alkaline earth metal borides, which are saltlike and ionic, they are not readily attacked by nonoxidizing acids and aqueous alkalis. Resistance to oxidation is greatest for the transition metal diborides and is lower for greater boron contents. The controlling factor is the surface layer of parent boron and transition-metal oxides, which prevents further oxidation up to temperatures at which boric oxide has appreciable volatility. Most metal borides are inert in hydrogen, nitrogen, and carbon, even at high temperatures. Chlorine and fluorine react vigorously with all borides, fluorine even at 400 °C. All types of borides are readily attacked by oxidizing molten salts such as nitrates and carbonates and hydroxides in the presence of air, and this is a usual method of decomposition for chemical analysis [206].

## 49.6.2 Production

Metal borides can be prepared by the following high-temperature reactions [191]:

1. Synthesis from the elements by melting, sintering, or hot-pressing
2. Borothermic reduction of metal oxides
3. Aluminothermic, silicothermic, or magnesiothermic reduction of metal oxide boric oxide mixture
4. Carbothermic reduction of metal oxide-boric oxide mixtures, e.g.,  
 $\text{TiO}_2 + \text{B}_2\text{O}_3 + 5\text{C} \rightarrow \text{TiB}_2 + 5\text{CO}$
5. Reduction of metal oxide with carbon and/or boron carbide, i.e., the boron carbide method e.g.,  
 $2\text{ZrO}_2 + \text{B}_4\text{C} + 3\text{C} \rightarrow 2\text{ZrB}_2 + 4\text{CO}$   
 $\text{Eu}_2\text{O}_3 + 3\text{B}_4\text{C} \rightarrow 2\text{EuB}_6 + 3\text{CO}$
6. Electrolysis of fused salts containing metal oxide and boric oxide
7. Auxiliary-metal bath method, M + B being dissolved in molten Al, Cu, Sn, or Pb
8. Deposition from the vapor phase involving coreduction of a metal halide–boron halide mixture by hydrogen, optionally as a plasma [207]

Reactions 1, 2, 6, 7, and 8 give pure products but are almost always restricted to the laboratory. For large-scale production, borides are prepared by reactions 4 and 5 followed by purification. These reactions are usually carried out in electric furnaces much like those for production of boron carbide. Molten metal borides often contain up to 3% carbon and boron carbide, although these impurities can be scavenged with additional metal oxide or boric oxide on reheating the powdered mixture above 1400 °C under a partial vacuum. After cooling, the metal boride is crushed and milled to its final grain size. Monolithic boride shapes usually are fabricated from commercial boride powders by powder metallurgy techniques:

- Cold forming — isopressing, slip casting, etc. — followed by pressureless sintering of the powder compact [207–210]

- Axial hot-pressing [211–214] and hot isostatic pressing [210, 215]

## 49.6.3 Uses

The principal use for metal diborides is as a crucible material for nonferrous metals, especially for aluminum, copper, magnesium, zinc, tin, and lead. Monolithic shapes of dense TiB<sub>2</sub> [216] are used for the electrolytic production of aluminum with the Hall–Héroult cell [217]. Their inertness to molten aluminum and cryolite and excellent electrical conductivity suggest titanium diboride and zirconium diboride as cathode leads, electrodes, and thermocouple sheaths in aluminum metallurgy [218]. Related uses are TiB<sub>2</sub>–BN–AlN hot-pressed composite crucibles, so-called evaporation boats, for the continuous evaporation of aluminum metal for vacuum metallizing [219]. The world production of TiB<sub>2</sub> is ≈ 100 t/a, much of this for the manufacture of these resistance-heated boats. The price of TiB<sub>2</sub> powder is \$15–35 per kg.

Calcium hexaboride, CaB<sub>6</sub>, is used as a deoxidizer for high-conductivity copper [220–222]. A major established use of NiB, CrB, and CrB<sub>2</sub> is the production of welding and hard facing alloys based on nickel–chromium–boron–silicon, called colmonoy [223].

The hardness and wear properties of borides are utilized economically as thin coatings on metal surfaces, prepared by the so-called boronizing process. Lanthanum hexaboride is useful as a high-current-density electrode for electron microscopes, electron-beam furnaces, and other devices of highest electronic emissivity. The lifetime of LaB<sub>6</sub> electrodes is reported to exceed that of tungsten cathodes by two orders of magnitude [224–225].

The refractory hexaboride of europium was suggested as a neutron absorber to control the power of fast breeder reactors. As a neutron absorber EuB<sub>6</sub> is equivalent to 35 mol% <sup>10</sup>B-enriched boron carbide, and its nuclear worth is ≈ 15% higher than europium sesquioxide [189, 192, 193].



## 49.7 Boric Oxide

Boric oxide ( $B_2O_3$ ) exists as vitreous glass and as two crystalline forms. The *vitreous form* is a colorless, hard, tough, glasslike solid, commonly prepared by dehydration of boric acid. The most common crystalline  $B_2O_3$  has a *hexagonal* or  $\alpha$ -form and is crystallized at 200–250 °C at ambient pressure. A less common *monoclinic*  $\beta$ -form can be crystallized at 4000 MPa and 600 °C [226].

### 49.7.1 Physical Properties

Vitreous  $B_2O_3$  is difficult to obtain in a completely anhydrous state even when heated at > 1000 °C [227]. Many physical properties of  $B_2O_3$  are sensitive to small amounts of residual water. Very dry  $B_2O_3$  can be prepared by heating at 200–400 °C in high vacuum [228]. Vitreous  $B_2O_3$  softens between 325 and 450 °C and the melt is still quite viscous at > 1000 °C. The dynamic viscosity of the melt is:

| $t, ^\circ\text{C}$ | $\eta, \text{Pa}\cdot\text{s}$ | $t, ^\circ\text{C}$ | $\eta, \text{Pa}\cdot\text{s}$ |
|---------------------|--------------------------------|---------------------|--------------------------------|
| 300                 | $4.4 \times 10^8$              | 800                 | 26                             |
| 400                 | $1.6 \times 10^8$              | 900                 | 12                             |
| 500                 | 3900                           | 1000                | 7.4                            |
| 600                 | 480                            | 1100                | 4.3                            |
| 700                 | 85                             |                     |                                |

The density ( $\rho$ ) of the vitreous form is dependent on both its thermal history and moisture content. Commercial boric oxide has a density of 1.84 g/cm<sup>3</sup>, whereas very dry  $B_2O_3$  has a density of 1.82 g/cm<sup>3</sup> at 20 °C. The density at high temperature has been investigated [229]. Annealed  $B_2O_3$  has a greater density compared to rapidly cooled melt (1.53 g/cm<sup>3</sup> when quenched from 1000 °C), implying a higher degree of molecular order in the annealed material [230]. The heat of formation of amorphous  $B_2O_3$  glass is 1260 kJ/mol [231].

Crystalline hexagonal or  $\alpha$ -form, *mp* 450 °C,  $\rho$  2.42–2.46 g/cm<sup>3</sup>; monoclinic or  $\beta$ -form, *mp* ca. 510 °C [232],  $\rho$  2.95 g/cm<sup>3</sup>; the  $\beta$ -form is much more resistant to attack by water and dilute HF than the  $\alpha$ -form.

The heat of formation for crystalline  $B_2O_3$  is 1274 kJ/mol. Its heat capacity increases

with temperature from 1.05 Jg<sup>-1</sup>K<sup>-1</sup> at 100 °C to 1.82 Jg<sup>-1</sup>K<sup>-1</sup> at 275 °C [233]. The heat of vaporization is calculated as 391.6 kJ/mol at 1800 °C [234], and the heat of sublimation is 431.4 kJ/mol at 25 °C [235]. The electrolytic conductivity ( $\kappa$ ) is only  $5 \times 10^{-4}$  S/cm at 300 °C [236]. The refractive index ( $n_D$ ) varies between 1.4502 and 1.4633, depending on the thermal history [228]. The vapor pressure of  $B_2O_3$  melt is [232, 237]:

|                          |        |       |      |      |      |      |
|--------------------------|--------|-------|------|------|------|------|
| $t, ^\circ\text{C}$      | 1163   | 1270  | 1673 | 1810 | 2000 | 2146 |
| $p_{B_2O_3}, \text{kPa}$ | 0.0005 | 0.005 | 1.5  | 5.7  | 24   | 80   |

The vapor composition (by mass spectrometry) is predominantly  $B_2O_3^+$  with about 7% each of  $B_2O_2^+$  and  $BO^+$  and 2%  $B^+$ . Boric oxide has been observed to be more volatile in steam than in a dry atmosphere. The green color of  $B_2O_3$  in a flame has been attributed to  $BO_2$  as the emitting species.

Historically there has been considerable controversy over the molecular structure in liquid and vitreous  $B_2O_3$ . The structure is believed to consist of a random network of trigonal  $BO_3$  units and boroxol rings with short-range localized order. There is disagreement over the relative amounts of these two structural units. A summary of the structural data has been reported [238].

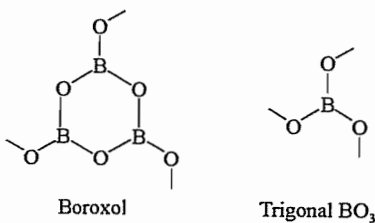

Apparently the structure interpretation can be influenced by the presence of residual moisture.

### 49.7.2 Chemical Properties

Molten  $B_2O_3$  is corrosive to most metals and alloys at temperatures exceeding 1000 °C. This is because of the fluxing character of  $B_2O_3$ , which keeps the metal surface clean and vulnerable to attack by oxygen in the air. Molybdenum and nickel alloys are resistant to

corrosion below 1000 °C, whereas silicon carbide is resistant above 1200 °C.

Reduction of  $B_2O_3$  at high temperatures by aluminum, magnesium, or alkali metals produces  $B_{12}O_3$  and other boron suboxides. Above 900 °C carbon reacts with  $B_2O_3$  in a nitrogen atmosphere to form boron nitride, which can also be made by reacting  $B_2O_3$  with ammonia at 600–900 °C.

Vitreous  $B_2O_3$  reacts exothermically with 3 mol of water to form crystalline boric acid, with a heat of hydration of -76.5 kJ/mol [239]; heat of hydration of crystalline  $B_2O_3$  is -8.2 kJ/mol. Above 135–140 °C boric oxide reacts with water to form metaboric acid.

Sodium hydride reacts with  $B_2O_3$  at 330–350 °C to give sodium borohydride in about 60% yield [240]. Reaction of either  $B_2O_3$  or boric acid with anhydrous  $H_2SO_4$  or oleum forms the acid  $HB(HSO_4)_4$  [241].

### 49.7.3 Production

High-purity  $B_2O_3$  (99%) is made by fusing refined boric acid. A 96% grade of  $B_2O_3$  is made commercially by fusing a mixture of sodium tetraborate plus sulfuric acid at 800 °C. Two molten layers are formed, an upper layer of boric oxide and a lower layer of sodium sulfate. The molten  $B_2O_3$  layer is separated and cooled on chill rollers. The resulting glass is ground, sized, and packaged in moisture-proof containers. The product  $B_2O_3$  contains 3–4% sodium sulfate.

Boric oxide can also be prepared by thermal decomposition of ammonium pentaborate,  $NH_4B_5O_8 \cdot 4H_2O$ , at 500–900 °C and through direct reaction of boron with oxygen [242].

## 49.8 Boric Acid

Boric acid can be viewed as a hydrate of boric oxide and exists both as a trihydrate, orthoboric acid ( $B_2O_3 \cdot 3H_2O$  or  $H_3BO_3$ ), and as a monohydrate, metaboric acid ( $B_2O_3 \cdot H_2O$  or  $HBO_2$ ). Only the more stable orthoboric acid form is of commercial importance and is usually referred to simply as boric acid. The terms "pyroboric acid" and "tetraboric acid"

are sometimes encountered in the literature, but these acids do not actually exist as solid-phase compounds.

### 49.8.1 Physical Properties

Boric acid crystallizes from an aqueous solution as odorless, white, waxy platelets. Crystalline orthoboric acid (*mp* 170.9 °C, heated in a closed space) is monoclinic, having a sheet lattice structure. Sheets consist of coplanar  $B(OH)_3$  molecules linked by hydrogen bonds. These sheetlike layers are held together only by van der Waals forces. This allows easy cleavage into flakes which feel slippery.

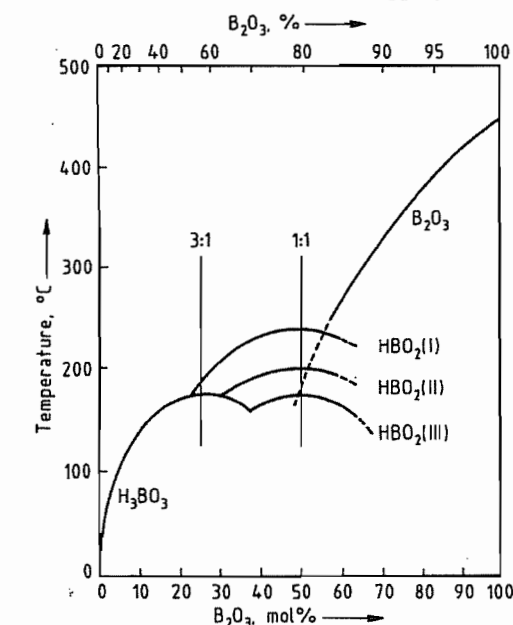

Figure 49.2: Solubility diagram for the system  $B_2O_3$ - $H_2O$ .

The three known crystalline modifications of metaboric acid are shown in the  $B_2O_3$ - $H_2O$  solubility phase diagram (Figure 49.2) [243]. Orthoboric acid slowly dehydrates at 100–130 °C to form flaky crystals of orthorhombic  $HBO_2$ (III) ( $\alpha$ -form, *d* 1.784, *mp* 176 °C). After disappearance of the residual  $H_3BO_3$  at temperatures up to 160 °C, a coarsely crystalline monoclinic  $HBO_2$ (II) ( $\beta$ -form, *d* 2.044, *mp* 201 °C) is formed. At yet higher tempera-

tures (200–250 °C) a highly viscous liquid is formed from which cubic HBO<sub>2</sub>(I) (γ-form, *d* 2.486, *mp* 236 °C) slowly crystallizes. With about 1% moisture remaining, HBO<sub>2</sub>(I) acts as seed for crystallization of hexagonal (α) boric oxide. The structures of these metaborate forms range from all trigonal borons in

HBO<sub>2</sub>(III), to one-third tetrahedral borons in HBO<sub>2</sub>(II), to all tetrahedral borons in HBO<sub>2</sub>(I).

The solubility of boric acid in water is increased by addition of salts, such as KCl, KNO<sub>3</sub>, RbCl, K<sub>2</sub>SO<sub>4</sub>, and Na<sub>2</sub>SO<sub>4</sub>, whereas addition of LiCl, NaCl, and CaCl<sub>2</sub> tends to lower the solubility.

Table 49.11: pH values of aqueous boric acid and borate solutions as a function of concentration.

| Compound   | <i>t</i> , °C | pH at % of compound |      |      |      |      |      |      |  |
|--|---------------|---------------------|------|------|------|------|------|------|--|
|  |               | 0.1                 | 0.5  | 1.0  | 2.0  | 4.0  | 10.0 | 15.0 |  |
| B(OH) <sub>3</sub> <sup>a</sup>  | 20            | 6.1                 | 5.6  | 5.1  | 4.5  | 3.9  |      |      |  |
| Na <sub>2</sub> B <sub>4</sub> O <sub>7</sub> ·10H <sub>2</sub> O                | 20            | 9.3                 | 9.2  | 9.2  | 9.2  | 9.3  |      |      |  |
| Ba <sub>2</sub> B <sub>3</sub> O <sub>8</sub> ·5H <sub>2</sub> O <sup>b</sup>    | 23            |                     |      | 8.5  | 8.4  | 8.1  | 7.6  | 7.3  |  |
| Na <sub>2</sub> B <sub>8</sub> O <sub>13</sub> ·4H <sub>2</sub> O                | 20            |                     |      | 8.5  | 8.5  | 8.1  | 7.6  | 7.3  |  |
| K <sub>2</sub> B <sub>4</sub> O <sub>7</sub> ·4H <sub>2</sub> O                  | 25            | 9.2                 | 9.1  | 9.1  | 9.2  | 9.3  |      |      |  |
| KB <sub>3</sub> O <sub>8</sub> ·4H <sub>2</sub> O <sup>c</sup>                   | 25            | 8.4                 | 8.4  | 8.4  | 8.1  | 7.9  |      |      |  |
| (NH <sub>4</sub> ) <sub>2</sub> B <sub>4</sub> O <sub>7</sub> ·4H <sub>2</sub> O | 25            | 8.8                 | 8.9  | 8.8  | 8.8  | 8.8  | 8.9  |      |  |
| NH <sub>4</sub> B <sub>3</sub> O <sub>8</sub> ·4H <sub>2</sub> O                 | 25            | 8.5                 | 8.4  | 8.3  | 8.2  | 7.9  | 7.3  |      |  |
| NaBO <sub>2</sub> ·4H <sub>2</sub> O   | 20            | 10.5                | 10.8 | 11.0 | 11.2 | 11.4 | 11.7 | 11.9 |  |

<sup>a</sup> Saturated solution at 20 °C, pH 3.7 at 4.7%.

<sup>b</sup> At 40 °C, pH 6.9 at 20%, pH 6.5 at 30%.

<sup>c</sup> pH 7.6 at 5.0%.

Table 49.12: Solubility of boric acid and borates in water.

| Compound   | Solubility, % (anhydrous salt), at temp., °C |      |      |      |      |      |      |         |      |         |       |
|--|--|------|------|------|------|------|------|---------|------|---------|-------|
|  | 0  | 10   | 20   | 30   | 40   | 50   | 60   | 70      | 80   | 90      | 100   |
| LiBO <sub>2</sub> ·8H <sub>2</sub> O <sup>a</sup>                                | 0.9  | 1.4  | 2.5  | 4.6  | 9.4  |      |      |         |      |         |       |
| LiBO <sub>2</sub> ·2H <sub>2</sub> O   |  |      |      |      | 7.4  | 7.8  | 8.4  | 9.5     | 10.6 | 11.9    | 13.4  |
| Li <sub>2</sub> B <sub>2</sub> O <sub>7</sub> ·3H <sub>2</sub> O                 | 2.5  |      | 2.8  | 3.0  | 3.2  | 3.5  | 3.8  | 4.1     | 4.4  | 4.9     | 5.4   |
| LiB <sub>3</sub> O <sub>8</sub> ·5H <sub>2</sub> O <sup>b</sup>                  |  |      |      | 17.9 | 18.7 | 20.9 | 24.3 | 28.0    | 32.0 | 36.6    | 41.42 |
| NaBO <sub>2</sub> ·4H <sub>2</sub> O <sup>c</sup>                                | 14.5   | 17.0 | 20.0 | 23.6 | 27.9 | 34.1 |      |         |      |         |       |
| NaBO <sub>2</sub> ·2H <sub>2</sub> O   |  |      |      |      |      |      | 38.3 | 40.9    | 43.7 | 47.4    | 52.4  |
| Na <sub>2</sub> B <sub>4</sub> O <sub>7</sub> ·10H <sub>2</sub> O <sup>d</sup>   | 1.0  | 1.6  | 2.5  | 3.8  | 5.9  | 9.5  | 16.0 |         |      |         |       |
| Na <sub>2</sub> B <sub>4</sub> O <sub>7</sub> ·5H <sub>2</sub> O                 |  |      |      |      |      |      | 16.4 | 19.5    | 23.4 | 28.1    | 34.6  |
| Na <sub>2</sub> B <sub>4</sub> O <sub>7</sub> ·4H <sub>2</sub> O <sup>e</sup>    |  |      |      |      | 14.2 | 14.7 | 17.0 | 19.7    | 23.0 | 27.2    |       |
| NaB <sub>3</sub> O <sub>8</sub> ·5H <sub>2</sub> O                               | 5.8  | 7.5  | 10.6 | 13.7 | 17.5 | 21.7 | 26.9 | 35.0    | 38.1 | 44.3    | 51.0  |
| B(OH) <sub>3</sub>   | 2.4  | 3.5  | 4.7  | 6.2  | 8.8  | 10.3 | 13.0 | 15.8    | 19.1 | 23.3    | 27.5  |
| KBO <sub>2</sub> ·4H <sub>2</sub> O <sup>f</sup>                                 | 34.2   | 38.2 | 43.8 |      |      |      |      |         |      |         |       |
| KBO <sub>2</sub> ·1.3H <sub>2</sub> O <sup>g</sup>                               | 35.5   |      |      | 44.4 | 45.5 | 46.4 | 47.5 | 48.5    | 49.6 | 50.6    | 51.6  |
| K <sub>2</sub> B <sub>4</sub> O <sub>7</sub> ·4H <sub>2</sub> O                  | 6.3  | 9.0  | 12.1 | 15.6 | 19.4 | 24.0 | 28.5 | 33.3    | 38.2 | 43.3    | 48.4  |
| K <sub>4</sub> B <sub>10</sub> O <sub>17</sub> ·5H <sub>2</sub> O                |  |      |      |      | 23.2 | 24.9 | 26.9 | 28.6    | 31.0 | 32.5    | 33.8  |
| KB <sub>3</sub> O <sub>8</sub> ·4H <sub>2</sub> O <sup>h</sup>                   | 1.6  | 2.1  | 2.8  | 3.8  | 5.1  | 6.9  | 9.0  | 11.7    | 14.7 | 18.3    | 23.3  |
| KB <sub>3</sub> O <sub>8</sub> ·2H <sub>2</sub> O <sup>i</sup>                   | 2.0  | 2.6  | 3.2  | 3.8  | 5.0  | 6.4  | 7.8  | 9.2     | 10.6 | 13.9    | 15.3  |
| Na <sub>2</sub> B <sub>8</sub> O <sub>13</sub> ·4H <sub>2</sub> O                | 1.9  | 3.7  | 7.8  | 18.1 | 22.9 | 26.4 | 28.9 | 39.3    |      | 37.4    |       |
|  |  |      |      |      |      |      |      | (75 °C) |      | (94 °C) |       |
| (NH <sub>4</sub> ) <sub>2</sub> B <sub>4</sub> O <sub>7</sub> ·4H <sub>2</sub> O | 3.8  | 5.3  | 7.6  | 10.8 | 15.8 | 21.2 | 27.2 | 34.4    | 43.1 | 52.7    |       |
| NH <sub>4</sub> B <sub>3</sub> O <sub>8</sub> ·4H <sub>2</sub> O                 | 4.0  | 5.4  | 7.1  | 9.1  | 11.4 | 14.4 | 18.2 | 22.4    | 26.4 | 30.3    |       |

<sup>a</sup> Transition of the 8-hydrate to the 2-hydrate at 36.9 with 7.2% LiBO<sub>2</sub>.

<sup>b</sup> Incongruent solubility below 37.5 or 40.5 °C.

<sup>c</sup> Transition of the 4-hydrate to the 2-hydrate at 53.6 °C with 36.9% NaBO<sub>2</sub>.

<sup>d</sup> Transition of the 10-hydrate to the 5-hydrate at 60.7 °C with 16.6% Na<sub>2</sub>B<sub>4</sub>O<sub>7</sub>.

<sup>e</sup> Transition of the 10-hydrate to the 4-hydrate at 58.2 °C with 14.6% Na<sub>2</sub>B<sub>4</sub>O<sub>7</sub>.

<sup>f</sup> Transition of the 4-hydrate to the 1.3-hydrate at 24 °C with 43.8% KBO<sub>2</sub>.

<sup>g</sup> Metastable below 24 °C.

<sup>h</sup> More stable below 46 °C.

<sup>i</sup> More stable above 46 °C.

Table 49.13: Solubility of boric acid and sodium tetraborate hydrates in organic solvents.

| Solvent                 | <i>t</i> , °C | Solubility, %      |   |  |   |
|-------------------------|---------------|--------------------|---|--|---|
|                         |               | B(OH) <sub>3</sub> | Na <sub>2</sub> B <sub>4</sub> O <sub>7</sub> ·10H <sub>2</sub> O | Na <sub>2</sub> B <sub>4</sub> O <sub>7</sub> ·5H <sub>2</sub> O | Na <sub>2</sub> B <sub>4</sub> O <sub>7</sub> |
| Methanol                | 20            | 20.68              |   |  |   |
|                         | 25            |                    | 19.9  | 16.9   | 16.7 <sup>a</sup>                             |
| Ethanol                 | 25            | 94.4 <sup>b</sup>  |   |  |   |
|                         | 15.5          |                    | 2.48  |  |   |
| Aqueous ethanol (46.5%) | 25            |                    |   |  |   |
| <i>n</i> -Butanol       | 25            | 42.8 <sup>b</sup>  |   |  |   |
| <i>n</i> -Propanol      | 25            | 59.4 <sup>b</sup>  |   |  |   |
| 2-Methylbutanol         | 25            | 35.3 <sup>b</sup>  |   |  |   |
| Isoamyl alcohol         | 25            | 2.39               |   |  |   |
| Ethylene glycol         | 25            | 18.5               | 41.6  | 31.2   | 15.5 <sup>c</sup>                             |
| Propylene glycol        | 25            | 15.06              |   | 21.9   |   |
| Diethylene glycol       | 25            | 13.6               |   | 18.6   |   |
| Glycerol (86.5%)        | 20            | 21.1               |   | 47.2   |   |
| Glycerol (98.5%)        | 20            | 19.9               |   | 52.6   |   |
| Glycerol                | 25            | 17.55              |   |  |   |
| Mannitol (10%)          | 25            | 6.62               |   |  |   |
| Acetone                 | 25            | 0.6                | 0.6   |  |   |
| Methyl ethyl ketone     | 20            | 0.7                |   |  |   |
| Methyl butyl ketone     | 20            | 0.23               |   |  |   |
| Ethyl acetate           | 25            | 1.5                | 0.14  |  |   |
| Acetic acid (glacial)   | 30            | 6.3                |   |  |   |
| Diethyl ether           | 20            | 0.008              |   |  |   |
| Dioxane                 | 25            | = 15 <sup>b</sup>  |   |  |   |
| Aniline                 | 20            | 0.15               |   |  |   |
| Pyridine                | 25            | = 70 <sup>b</sup>  |   |  |   |
| Ammonia (liquid)        | 25            | 1.88               |   |  |   |
| Formamide               | 25            |                    |   |  | 40.6 <sup>b</sup>                             |
| Fuel oil                | 25            | 2.46               |   |  |   |
| Water                   | 25            | 5.46               |   |  |   |
|                         | 20            | 4.72               |   |  |   |

<sup>a</sup> Finely divided solid.

<sup>b</sup> Solubility, g/L.

<sup>c</sup> Viscous solution.

Boric acid behaves as a weak acid in aqueous solutions, *pK<sub>a</sub>* of 9.23 at 25 °C [244]. As shown in Table 49.11, pH decreases as concentration increases. This is because of formation of trimeric and tetrameric species. The pH also increases with temperature. The solubility of boric acid in water is shown in Table 49.12.

The solubility of boric acid in many organic solvents is shown in Table 49.13. Boric acid is particularly soluble in polyhydric alcohols capable of forming complexes. Normally, boric acid is too weak an acid to titrate directly. Use of a polyhydric complexing agent, such as mannitol, enhances the acidity of boric acid sufficiently to allow accurate titration using phenolphthalein as the indicator.

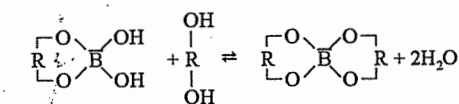
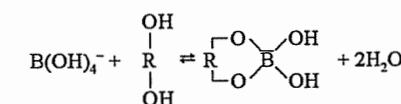

where R = -(CHOH-)<sub>4</sub>- (mannitol).

The vapor pressure of boric acid is primarily due to water from dehydration equilibria. Vapor below 160 °C is composed of water and boric acid molecules. At higher temperatures, HBO<sub>2</sub> is also found in the vapor phase, and above 940 °C (HBO<sub>2</sub>)<sub>3</sub> becomes significant [245].

Boric acid is volatile with steam. Distillate from a boiling saturated solution contains

about 0.18% of boric acid [246]. Boric acid is particularly volatile from concentrated solutions made acidic by strong acids. The volatile loss from low molecular mass alcohol solutions can be attributed to ester formation.

### 49.8.2 Chemical Properties

Boric acid reacts with strong bases to form metaborate ion,  $B(OH)_4^-$ , and with alcohols to form borate esters. Boric acid reacts with fluoride ion to form tetrafluoroboric acid and with hydrofluoric acid to form trifluoroboric acid  $H(F_3BOH)$ , which can be distilled at reduced pressures (58.5–60.0 °C at 0.16 kPa) [247].

### 49.8.3 Production

Boric acid is manufactured industrially from borate minerals and brines [248]. Alkali and alkaline-earth metal borates, such as borax, kernite, colemanite, ascharite, ulexite, or hydroboracite, react with strong mineral acids to form boric acid. In the United States boric acid is made primarily from sodium borate minerals, whereas in Europe it is made from colemanite imported from Turkey. In Kazakhstan magnesium borates from the Inder region are used to make boric acid. Borates found in saline lake brine in California at Searles Lake are extracted and recovered as boric acid.

The world's largest and most modern boric acid plant was constructed by U.S. Borax in 1981 at Boron, California. Crushed kernite ( $Na_2O \cdot 2B_2O_3 \cdot 4H_2O$ ) ore is reacted with sulfuric acid in recycled weak liquor (contains low concentration of borates) at 100 °C. Coarse gangue is separated by rake classifiers and fine particles are settled in a thickener. The boric acid strong liquor (high borate concentration) is nearly saturated with sodium sulfate. Complete solubility of sodium sulfate is maintained throughout the process by careful control of pH and temperature. The strong liquor is filtered at 98 °C and boric acid crystallized in two stages using continuous evaporative crystallizers. The temperature is dropped to 70 °C in the first stage and to 35 °C in the second. Crystals are filtered and washed

with progressively weaker liquor in a counter-current fashion. The final product is dried in rotary driers and screened for packaging. Weak liquor at 35 °C, nearly saturated in sodium sulfate, is heated to 100 °C and returned to the reactor. Sodium sulfate is removed from the process as solid in gangue and in effluent from a second-stage thickener, and is pumped to sealed solar ponds. The plant has a capacity of 113 000 t/a (expressed as  $B_2O_3$ ).

In Europe boric acid is produced from crushed colemanite ( $2CaO \cdot 3B_2O_3 \cdot 5H_2O$ ) ore by reaction with sulfuric acid at 90 °C. By-product gypsum ( $CaSO_4$ ) and gangue are filtered and the hot mother liquor cooled to crystallize boric acid. The weak liquor is recycled to the reactor.

Magnesium borate ores, primarily of ascharite (szaibelyite,  $2MgO \cdot B_2O_3 \cdot H_2O$ ), and hydroboracite ( $CaO \cdot MgO \cdot 3B_2O_3 \cdot 6H_2O$ ), are finely ground and decomposed to boric acid with sulfuric acid at 95 °C. Insoluble gypsum and gangue are filtered and the mother liquor is cooled to 15 °C to crystallize boric acid. The weak liquor is nearly saturated in magnesium sulfate ( $MgSO_4 \cdot 7H_2O$ ), which is crystallized by concentration of the liquor at elevated temperature; the concentrated liquor is then recycled to the reactor.

Datolite ( $2CaO \cdot B_2O_3 \cdot 2SiO_2 \cdot H_2O$ ) is the most common silicoborate mineral. Ore containing 5%  $B_2O_3$  is finely ground and digested with sulfuric acid. Silica in the mother liquor is coagulated upon heating to 95 °C. The resulting boric acid solution is nearly free of silicic acid.

At Searles Lake, California, borax is found in brine at a concentration of about 1.5% (expressed as anhydrous borax); a number of other salts are also present. A process using liquid-liquid extraction is used to separate borax selectively from brine. Borax is extracted into a water-insoluble solvent, such as kerosene, by use of an aromatic polyol that efficiently complexes the borate ion, e.g., 3-chloro-2-hydroxy-5-isooctylbenzenemethanol. The organic phase is isolated and acidified with sulfuric acid, giving an aqueous solution of boric acid and sodium sulfate. Af-

ter concentrating by evaporation, the liquor is cooled to crystallize boric acid.

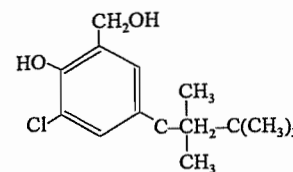

3-Chloro-2-hydroxy-5-isooctylbenzenemethanol

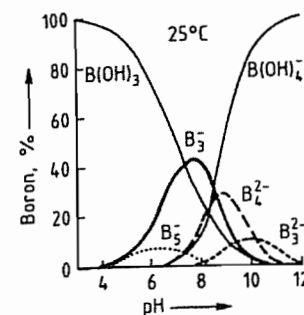
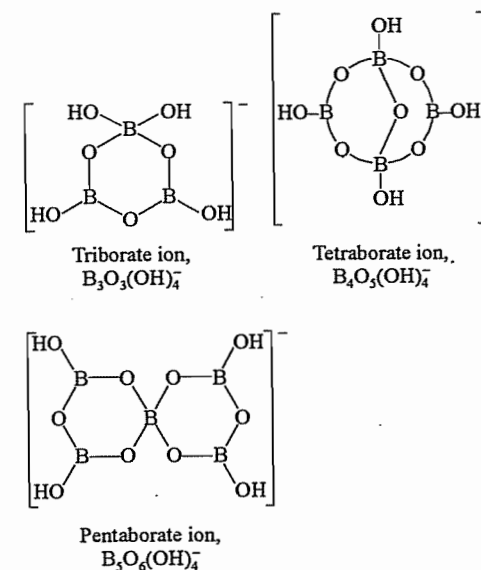

Figure 49.3: Distribution of borate polyanion species in aqueous solution:  $B_3^- = B_3O_3(OH)_4^-$ ;  $B_4^{2-} = B_3O_3(OH)_5^{2-}$ ;  $B_5^- = B_5O_6(OH)_4^-$ ;  $B_6^{2-} = B_5O_5(OH)_4^{2-}$  [243].

### 49.9 Aqueous Borate Solutions

Dilute borate solutions contain only monomeric species. Solutions of boric acid below 0.1 M contain monomeric boric acid molecules,  $B(OH)_3$ , and solutions of metaborate salts contain monomeric metaborate ions,  $B(OH)_4^-$ . Solutions made from mixtures of boric acid and metaborate salts contain a mixture of  $B(OH)_3$  molecules and  $B(OH)_4^-$  ions.

Polymeric borate anions form in more concentrated borate solutions. In addition to monomeric  $B(OH)_3$  and  $B(OH)_4^-$ , concentrated borate solutions contain the polyions  $B_3O_3(OH)_4^{2-}$ ,  $B_3O_3(OH)_5^{2-}$ ,  $B_5O_6(OH)_4^-$ , and  $B_4O_5(OH)_4^{2-}$  (Figure 49.3). These polyion species are all in rapid dynamic equilibrium and their distribution is dependent on the  $Na_2O-B_2O_3$  molar ratio, temperature, and borate salt concentration, but is essentially independent of the cation [249].



The pH of borate salt solutions varies with both concentration (see Table 49.11) and temperature as a consequence of these polyions. At the isohydric point the pH value is independent of borate concentration. This occurs at a pH of 8.9 and a  $Na_2O-B_2O_3$  molar ratio of 0.41 for a sodium borate solution. Borate solutions with a  $Na_2O-B_2O_3$  molar ratio less than 0.4 become more acidic at higher concentrations, whereas solutions with a  $Na_2O-B_2O_3$  molar ratio greater than 0.4 become more alkaline with increasing concentration (Figure 49.4). Borax, with a  $Na_2O-B_2O_3$  molar ratio of 0.5 makes an excellent buffer solution.

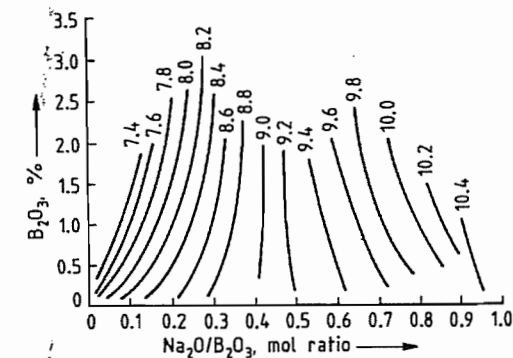

Figure 49.4: pH values in the system  $Na_2O-B_2O_3-H_2O$  at 25 °C [250].

## 49.10 Sodium Borates

The lack of a uniform system of nomenclature for naming metal borate salts has led to ambiguities in the past. Today metal borates are most commonly described by an empirical formula with the number of cations and boron atoms in the simplest stoichiometric units. The descriptive name is derived from this formula. In addition, an oxide formula is also in common use with the derived portions of metal oxide, boric oxide, and water in the simplest molar ratio. Many metal borates are also described using the mineral name, e.g., tincal for borax,  $\text{Na}_2\text{B}_4\text{O}_7 \cdot 10\text{H}_2\text{O}$ . Although useful for cataloging metal borates these formulas give no indication of the molecular structure of the borate anion found in the solid crystals. The solubilities of the borates described in this chapter are summarized in Table 49.12. Of the sodium borates discussed, only borax decahydrate and borax pentahydrate are sold in large commercial volume.

**Sodium tetraborate decahydrate**, borax, tincal,  $\text{Na}_2\text{O} \cdot 2\text{B}_2\text{O}_3 \cdot 10\text{H}_2\text{O}$  or  $\text{Na}_2\text{B}_4\text{O}_7 \cdot 10\text{H}_2\text{O}$ , crystals are odorless, white, monoclinic prisms with a relative density of 1.715. Based on the crystal structure, borax is best represented by the formula  $\text{Na}_2[\text{B}_4\text{O}_5(\text{OH})_4] \cdot 8\text{H}_2\text{O}$ , with 2 mol of water existing as hydroxyl groups and 8 mol as water of crystallization [251]. The water in borax can be maintained at exactly 10 mol by storage in a closed container with a relative humidity produced by a solution saturated in both sucrose and salt [252].

Borax decahydrate slowly dehydrates at ambient conditions, depending on the relative humidity, to a water content of about 7 mol. The dehydration path is dependent on the thermal history of the sample [252]. Freshly crystallized borax previously heated to about 50 °C has a vapor pressure of 1.33 kPa at 19.8 °C and follows a stable dehydration path. That is, it dehydrates reversibly to borax pentahydrate at ambient temperature with a heat of dehydration of 54.17 kJ/mol. Further dehydration under vacuum produces an amorphous

product containing 2 mol of water. Freshly crystallized borax decahydrate maintained below 50 °C has a vapor pressure of only 0.22 kPa at 20 °C and follows an unstable dehydration path. At ambient pressure and temperature over  $\text{H}_2\text{SO}_4$  it undergoes irreversible dehydration leading directly to the amorphous hydrate (2 mol  $\text{H}_2\text{O}$ ), bypassing borax pentahydrate. This hydrate can rehydrate first to borax pentahydrate and then to borax decahydrate.

Borax heated in a closed container melts in its own water of hydration at about 60 °C. Borax loses 5 mol of water by heating from 50 to 100 °C and loses an additional 3 mol up to 160 °C (determined by thermal gravimetric analysis). The remaining 2 mol of water are slowly lost during heating to about 400 °C. Anhydrous borax fuses at 742 °C forming a clear glass.

Rapid heating of borax decahydrate causes puffing [253]. Puffed borax consists of small glassy hollow spheres with a void volume as high as 90% and a bulk density of about 0.07 g/cm<sup>3</sup>.

Borax has a heat of formation of -6264.3 kJ/mol [254], and a specific heat of 1.611 kJ kg<sup>-1</sup>K<sup>-1</sup> at 25–50 °C [255].

Borax decahydrate crystallizes from aqueous solution below 60.8 °C, the decahydrate-pentahydrate transition temperature (Figure 49.5). This transition temperature is lowered by addition of either boric acid or sodium hydroxide [256]. In a solution saturated with sodium sulfate this transition temperature drops to 39.6 °C; with sodium chloride it drops to 35.5 °C. The solubility of borax in organic solvents is shown in Table 49.13.

The pH value of a borax solution increases slightly with increasing concentration (Table 49.11), and drops slightly with increasing temperature [257].

**Sodium tetraborate pentahydrate**, tincalconite,  $\text{Na}_2\text{O} \cdot 2\text{B}_2\text{O}_3 \cdot 5\text{H}_2\text{O}$  or  $\text{Na}_2\text{B}_4\text{O}_7 \cdot 5\text{H}_2\text{O}$ , crystals have rhombohedral symmetry and resemble octahedra; their relative density is

1.880. This pentahydrate has the same polyanion structure as borax decahydrate and is best represented by the formula  $\text{Na}_2[\text{B}_4\text{O}_5(\text{OH})_4] \cdot 3\text{H}_2\text{O}$ , with 3 mol of water of crystallization and 2 mol of water existing as hydroxyl groups. Pure borax pentahydrate actually contains 4.75 mol rather than 5.0 mol of water because of apparent vacancies in the crystal structure [258].

Borax pentahydrate rapidly crystallizes from aqueous solution above 60.8 °C (Figure 49.5). Solid pentahydrate in equilibrium with its saturated solution is metastable to kernite at all temperatures above 58.2 °C. When a solution saturated with borax pentahydrate is heated for one day or more, kernite crystals slowly form [259]. The solubility of tincalconite in organic solvents is shown in Table 49.13.

From thermogravimetric analysis 3 mol of water are lost on heating borax pentahydrate at 160 °C. The last 2 mol are slowly lost up to about 400 °C. Pentahydrate dehydrates reversibly to an amorphous dihydrate on heating at 80 °C and 0.3 kPa pressure or at 140 °C in air.

Like borax decahydrate, borax pentahydrate puffs when rapidly heated [253].

The heat of formation for borax pentahydrate is -4784 kJ/mol [254] and the specific heat is 1.318 kJ kg<sup>-1</sup>K<sup>-1</sup> [255].

**Production.** Refined borates are almost exclusively produced as a sodium salt, with a minor amount of potassium salt and even smaller amounts of lithium and ammonium salts.

The largest source of refined sodium borate products in the world is currently located at the U.S. Borax mine and refinery in Boron, California.

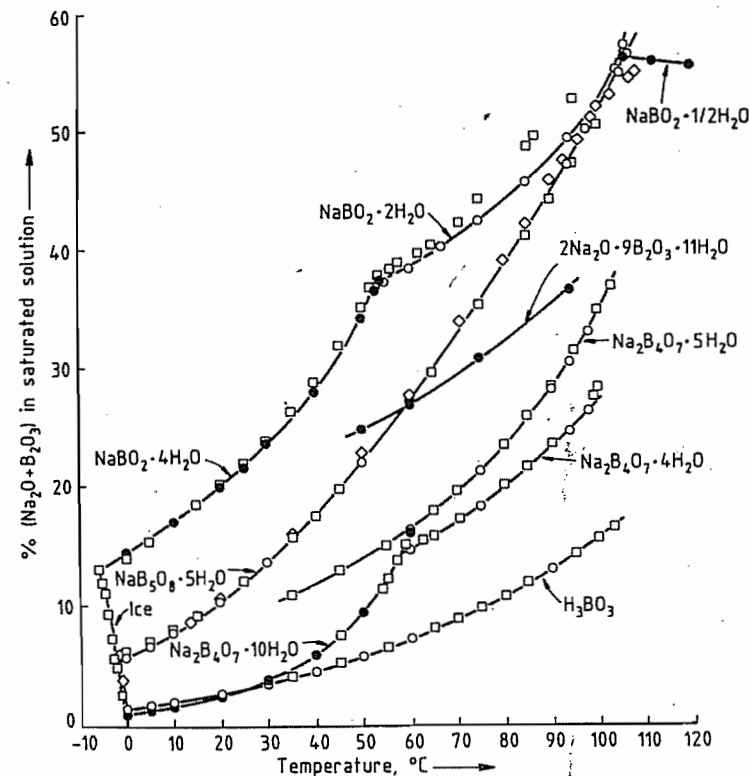

Figure 49.5: Solubility versus temperature curves for borate hydrates [256].

Sodium borate ore consisting primarily of tincal and clay is crushed, mixed with Trona, and dissolved in weak liquor at 100 °C. The coarse gangue is separated on a screen and strong liquor and fine insolubles are transferred to a primary thickener. Clarified strong liquor is used to produce borax pentahydrate in continuous vacuum crystallizers at a temperature above the borax penta-decahydrate transition temperature of 60.8 °C. Borax decahydrate product crystallizes below this transition temperature. Crystals are filtered using a continuous centrifuge and dried in rotary driers. Borax crystals are washed with a weak boric acid solution leaving a very thin surface coat of pentaborate, which inhibits caking. Thickened underflow from the primary thickener is washed in a countercurrent fashion through four thickener stages with progressively weaker liquor in each stage. Fresh water is added to the last stage thickener. Liquid effluent is pumped to sealed solar ponds. The plant B<sub>2</sub>O<sub>3</sub> capacity is 2030 t/d.

Calcium and sodium calcium borate ores were once a major source for borax production, but since the discovery of the high-grade borax deposit in California they are of less importance. Ulexite (Na<sub>2</sub>O·2CaO·5B<sub>2</sub>O<sub>3</sub>·6H<sub>2</sub>O) is preferred over calcium borates and borosilicates because less alkali is required and less insoluble calcium salts are produced. Ulexite (ca. 38% B<sub>2</sub>O<sub>3</sub>), which is finely ground and preferably calcined at 390 °C, is heated with aqueous sodium carbonate and sodium hydrogen carbonate to a near boil for several hours. The insoluble calcium carbonate is filtered and borax crystallized from the mother liquor in about 91–96% yield.

Borax is recovered from upper lake brines by Kerr McGee at Searles Lake in California by heating and evaporating water to precipitate NaCl, Na<sub>2</sub>CO<sub>3</sub>, and Na<sub>2</sub>SO<sub>4</sub>. The hot liquor, which is nearly saturated in KCl, is then rapidly cooled in a vacuum crystallizer to precipitate KCl. The cool mother liquor, which is supersaturated with borax, is treated with NaHCO<sub>3</sub> to crystallize crude borax pentahydrate. This crude material is washed with brine and recrystallized as either borax deca- or pen-

tahydrate. In a carbonation process borax is recovered from the lower brines by treatment with purified flue gas, causing NaHCO<sub>3</sub> to precipitate. The filtrate is neutralized with raw brine and cooled to crystallize crude borax.

A very pure grade of borax can be produced by reacting refined boric acid with hot NaOH solution and crystallizing the resulting borax.

**Anhydrous sodium tetraborate**, anhydrous borax, Na<sub>2</sub>O·2B<sub>2</sub>O<sub>3</sub> or Na<sub>2</sub>B<sub>4</sub>O<sub>7</sub>. Fused borax forms an amorphous glass when rapidly cooled (density 2.36 g/cm<sup>3</sup>). When slowly cooled orthorhombic crystals (α-form) are obtained. A β- and γ-form also exist [260]. The α-form is the most stable form with a congruent melting point at 742.5 °C. Its heat of formation has been calculated as -3290 kJ/mol [261], and its vapor pressure is 0.73 kPa at 1200 °C, 1.73 kPa at 1250 °C, and 3.39 kPa at 1300 °C. Anhydrous borax dissolves more slowly in water than hydrated forms, giving off a large amount of heat; heat of hydration is 161 kJ/mol. The integral heat of solution in water to give a 2.5% solution is -192.6 J/g at 51.5 °C and 190.5 J/g at 60 °C. The solubility in several organic solvents is shown in Table 49.13.

The melt attacks most refractories at 800 °C. Many metal oxides are soluble in borax glass giving characteristic colors. Anhydrous borax reacts with carbon at 1200 °C in the absence of oxygen to form B<sub>4</sub>C<sub>3</sub> and Na<sub>2</sub>C<sub>2</sub>, and reacts with metallic sodium to form elemental boron.

**Production.** Anhydrous borax is produced commercially by dehydration of hydrated sodium tetraborates in large fusion furnaces to form a borate glass. Anhydrous borax melts at 742 °C and this melt readily supercools to an amorphous glass. A crystalline form can be obtained by prolonged annealing or by seeding. The melt is very corrosive to furnace refractories and methods have been devised to keep borax away from the furnace walls [262].

**Sodium metaborate tetrahydrate**, Na<sub>2</sub>O·B<sub>2</sub>O<sub>3</sub>·8H<sub>2</sub>O or NaBO<sub>2</sub>·4H<sub>2</sub>O, crystals are triclinic with a density of 1.743 g/cm<sup>3</sup>. From X-ray studies the structure is best represented by

the formula NaB(OH)<sub>4</sub>·2H<sub>2</sub>O, containing B(OH)<sub>4</sub><sup>-</sup> ions [263]. Crystals begin to melt in their own water of hydration at 53.5 °C. At low humidity water is lost forming the dihydrate. By differential thermal analysis (DTA) 1 mol of water is lost at 130 °C, a second at 140 °C, and a third at 280 °C; the remaining water is slowly lost up to 800 °C. Heat of hydration is 52.51 kJ/mol.

Sodium metaborate tetrahydrate is the stable solid phase in contact with its saturated solution between 11.5 and 53.6 °C. Solutions are easily supersaturated. Both crystals and solutions absorb carbon dioxide from air forming borax and sodium carbonate. The pH of aqueous solutions increases with concentration (Table 49.11).

**Production.** Sodium metaborate tetrahydrate is made commercially by crystallization (< 30 °C) from a solution containing borax and a slight excess of sodium hydroxide.

A solution of sodium metaborate, prepared from borax pentahydrate and sodium hydroxide, is reacted with hydrogen peroxide on a large commercial scale to produce sodium perborate tetrahydrate, NaBO<sub>3</sub>·4H<sub>2</sub>O or Na<sub>2</sub>O·B<sub>2</sub>O<sub>3</sub>·2H<sub>2</sub>O<sub>2</sub>·6H<sub>2</sub>O, containing about 10% available oxygen. Sodium perborate crystallizes in transparent monoclinic crystals, which are comparatively stable in air [264]. Its aqueous solution slowly decomposes; decomposition is accelerated by catalysts or elevated temperature.

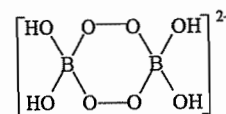

Perborate anion

**Sodium metaborate dihydrate**, Na<sub>2</sub>O·B<sub>2</sub>O<sub>3</sub>·4H<sub>2</sub>O or NaBO<sub>2</sub>·2H<sub>2</sub>O, crystals are triclinic with a relative density of 1.909. The dihydrate is crystallized from aqueous solutions at 53.6–105 °C. When solutions are cooled rapidly very small needles, which are difficult to filter, form. Large platelike crystals form over several days during slow crystallization at 54–80 °C [265].

Sodium metaborate dihydrate slowly loses water at ambient temperatures and becomes sticky when heated. The heat of dehydration is 58.2 kJ/mol [266]. A monohydrate can be produced by dehydrating the dihydrate or by crystallization from highly basic solutions above 40 °C. Anhydrous sodium metaborate, NaBO<sub>2</sub>, formed by heating to 350 °C, is very hygroscopic. At 966 °C it melts forming a clear glass.

**Sodium pentaborate pentahydrate**, sbergite, Na<sub>2</sub>O·5B<sub>2</sub>O<sub>3</sub>·10H<sub>2</sub>O or NaB<sub>5</sub>O<sub>8</sub>·5H<sub>2</sub>O, crystals are triclinic with a density of 1.713 g/cm<sup>3</sup>. The heat capacity, heat content, and entropy and other thermal functions have been reported from 0 to 345 K [267].

Sodium pentaborate is stable in contact with its saturated solution between 2 and 59.5 °C. Below 2 °C borax forms, and above 59.5 °C, 2Na<sub>2</sub>O·9B<sub>2</sub>O<sub>3</sub>·11H<sub>2</sub>O, Taylor's borate (*d* 1.903), slowly crystallizes if seeds are present. Supersaturated aqueous solutions of Taylor's borate easily form up to the boiling point. Still lower hydrates of 4, 2, 1, and 0 mol of water crystallize at temperatures above 100 °C under pressure [268].

**Production.** Sodium pentaborate can be made by gradually heating borax and boric acid (1:6 molar ratio) in a rotary drier from 30 to 66 °C [269]. It is also made by spray drying a borate solution of the appropriate composition.

**Disodium octaborate tetrahydrate**, Na<sub>2</sub>O·4B<sub>2</sub>O<sub>3</sub>·4H<sub>2</sub>O or Na<sub>2</sub>B<sub>8</sub>O<sub>13</sub>·4H<sub>2</sub>O, is a spray-dry product. It is an amorphous solid, and is sold under the trade name Polybor; boron content is high (67.1% B<sub>2</sub>O<sub>3</sub>), as is solubility in water. It is easily dissolved in cool water to give supersaturated solutions of considerable concentration. Above 60 °C, concentrated solutions become quite viscous. In aqueous solution the pH decreases with concentration (Table 49.11).

**Disodium tetraborate tetrahydrate**, kernite, Na<sub>2</sub>O·2B<sub>2</sub>O<sub>3</sub>·4H<sub>2</sub>O or Na<sub>2</sub>B<sub>4</sub>O<sub>7</sub>·4H<sub>2</sub>O, forms monoclinic crystals (*d* 1.908) consisting of infinite linear chains of the polyanion

$[B_4O_6(OH)_2]_n^{2-}$  made up of fused six-membered rings [270]. The heat of formation at 24 °C is -4489.0 kJ/mol [254]. Crystal cleavage forms long fibrous needles.

Borax pentahydrate is metastable to kernite when in contact with its saturated aqueous solution above 58.2 °C (Figure 49.5). However, the rate of crystallization and of dissolution of kernite is very slow compared to borax pentahydrate. Calcined kernite dissolves at a considerably faster rate compared to the tetrahydrate.

Kernite hydrates irreversibly to borax decahydrate under ambient conditions. It dehydrates reversibly to the dihydrate, metakernite, over  $P_2O_5$  in a vacuum or by heating at 100–120 °C. Further dehydration by heating to 190 °C causes irreversible dehydration forming an amorphous monohydrate. Rehydration of this monohydrate forms borax penta- and decahydrate.

Heating kernite to 180 °C results in the loss of 3 mol of water (DTA). The last mole of water is slowly lost up to 400 °C.

## 49.11 Other Metal Borates

### 49.11.1 Calcium and Calcium Sodium Borates

Calcium and calcium sodium borates are next to sodium borates in commercial importance. This includes the minerals colemanite, ulexite, and probertite.

**Colemanite**,  $2CaO \cdot 3B_2O_3 \cdot 5H_2O$  or  $Ca_2B_6O_{11} \cdot 5H_2O$ , is the most widely occurring calcium borate mineral. Crystals of pure colemanite are monoclinic with a relative density of 2.42 and heat of formation of -3469 kJ/mol. Its crystal structure is represented by the formula  $Ca_2B_6O_9(OH)_6 \cdot 2H_2O$  and is made up of polymeric chains of  $[B_3O_4(OH)_3]^{2-}$  anions [271]. The solubility in water at 25 °C is about 0.18% as  $B_2O_3$  and 0.38% at 100 °C. At about 350 °C, colemanite decrepitates violently losing all its water of hydration.

**Ulexite**,  $Na_2O \cdot 2CaO \cdot 5B_2O_3 \cdot 16H_2O$  or  $NaCaB_5O_6 \cdot 8H_2O$ , forms triclinic needles with a density of 1.955 g/cm<sup>3</sup>. The crystal structure consists of discrete pentaborate rings and is represented by the formula  $NaCaB_5O_6(OH)_6 \cdot 5H_2O$  [272]. By DTA ulexite dehydrates losing 4 mol of water at 70–90 °C, and another 8 mol between 100 and 120 °C; the remaining water is gradually lost up to about 400 °C.

The solubility of ulexite in water is about 0.49% as  $NaCaB_5O_9$  at 25 °C. Calcination at 200–500 °C increases the solubility to 9–13 g/L [273].

Ulexite can be prepared by reacting borax, calcium metaborate, and water at 20 °C for 119 d or at 40 °C for 60 d [259]. Also moistened probertite heated at 80–100 °C forms ulexite in about four weeks [274].

**Probertite**,  $Na_2O \cdot 2CaO \cdot 5B_2O_3 \cdot 10H_2O$  or  $NaCaB_5O_9 \cdot 5H_2O$ , exists as monoclinic crystals with a density of 2.14 g/cm<sup>3</sup>. It has a crystal structure of  $NaCaB_5O_7(OH)_4 \cdot 3H_2O$  and is made up of pentaborate rings linked in polymeric chains [272]. Probertite is a commonly found scale in borax refineries. By DTA 2 mol of water are lost at about 100 °C, 4 mol more between 100 and 180 °C, and the last 4 mol are slowly lost up to 400 °C. Probertite can be prepared by heating borax and calcium metaborate for 8 d at 105 °C [229].

### 49.11.2 Lithium, Potassium, and Ammonium Borates

Borates of lithium, potassium, and ammonium are of much smaller commercial volume than those described in Section 49.11.1.

#### 49.11.2.1 Lithium Borates

**Lithium metaborate octahydrate**,  $Li_2O \cdot B_2O_3 \cdot 16H_2O$  or  $LiBO_2 \cdot 8H_2O$ , with a trigonal crystal structure, is the stable solid in contact with saturated aqueous solutions below 36.9 °C [275]. Heating the crystals causes rapid loss of 6 mol of water below 70 °C, forming orthorhombic crystals of a dihydrate,  $Li_2O \cdot B_2O_3 \cdot 4H_2O$  or  $LiBO_2 \cdot 2H_2O$ , with a

density of 1.825 g/cm<sup>3</sup>. This dihydrate is the stable solid in contact with its saturated solution above 36.9 °C.

**Lithium pentaborate pentahydrate**,  $Li_2O \cdot 5B_2O_3 \cdot 10H_2O$  or  $LiB_5O_8 \cdot 5H_2O$ , has an incongruent solubility reported as both < 37.5 °C and 40.5 °C. By DTA the solid loses 3.7 mol of water when dehydrated between 110 and 200 °C and an additional 0.8 mol are lost up to 300 °C; it becomes anhydrous at 450 °C.

**Dilithium tetraborate trihydrate**,  $Li_2O \cdot 2B_2O_3 \cdot 3H_2O$  or  $Li_2B_4O_7 \cdot 3H_2O$ , has a density of 1.88 g/cm<sup>3</sup>. When crystallized from an aqueous solution, a variety of hydrates form; when boiled the trihydrate forms [275]. Dehydration occurs at 260 °C and fusion at about 890 °C.

#### 49.11.2.2 Potassium Borates

**Potassium tetraborate tetrahydrate**,  $K_2O \cdot 2B_2O_3 \cdot 4H_2O$  or  $K_2B_4O_7 \cdot 4H_2O$ , is the most common of this class. Crystals are orthorhombic, having a relative density of 1.92 and a borate anion structure similar to borax [276]. The solid loses 2 mol of water between 112 and 180 °C, with a heat of dehydration of 86.6 kJ/mol; the last 2 mol are gradually lost between 180 and 420 °C. Potassium tetraborate is more soluble than the corresponding sodium tetraborate. In contact with its saturated solution above 56 °C, it is metastable to tetrapotassium decaborate pentahydrate,  $2K_2O \cdot 5B_2O_3 \cdot 5H_2O$  or Auger's potassium borate. This Auger's form is very slow to crystallize in the absence of seed. The pH value of aqueous potassium tetraborate solutions increases slightly with concentration (Table 49.11).

Potassium tetraborate can be crystallized from aqueous solutions of potassium hydroxide and boric acid with a  $B_2O_3$ - $K_2O$  molar ratio of 2.0. It can also be crystallized from borax solutions by addition of potassium chloride.

**Potassium pentaborate**,  $K_2O \cdot 5B_2O_3 \cdot 8H_2O$  or  $KB_5O_8 \cdot 4H_2O$ , crystals are orthorhombic with a relative density of 1.74, *mp* 780 °C, and heat capacity of 330.5 Jmol<sup>-1</sup>K<sup>-1</sup> at 298 K

[267]. The heat of dehydration is 110.8 kJ/mol between 106 and 134 °C. Potassium pentaborate is less soluble than the sodium analog. The pH value of its aqueous solution decreases with concentration (Table 49.11). Potassium pentaborate can be crystallized from a solution of potassium hydroxide and boric acid with a  $B_2O_3$ - $K_2O$  molar ratio of about 5.0.

#### 49.11.2.3 Ammonium Borates

**Ammonium pentaborate octahydrate**,  $(NH_4)_2O \cdot 5B_2O_3 \cdot 8H_2O$  or  $NH_4B_5O_8 \cdot 4H_2O$ , exists in two crystalline forms: an orthorhombic  $\alpha$ -form with a relative density of 1.567 and heat capacity of 359.4 Jmol<sup>-1</sup>K<sup>-1</sup> at 301.2 K, and a monoclinic  $\beta$ -form. The crystal structure of ammonium pentaborate has the same borate ion  $[B_5O_6(OH)_4]^-$  found in sodium and potassium pentaborates. Unlike diammonium tetraborate the pentaborate is very stable to ammonia loss. At 150 °C all but 2 mol of water are lost, with less than 1% ammonia loss [250]. At 200 °C and 0.1 kPa one more molecule of water is lost with only 2% ammonia loss.

Ammonium pentaborate tetrahydrate can be crystallized from an aqueous solution of ammonia and boric acid with a  $B_2O_3$ - $(NH_4)_2O$  molar ratio of 5.0 [277]. To determine its solubility in water, long equilibration times are required. For this reason solubility data published prior to 1966 are suspect [278]. The pH value decreases with solution concentration (Table 49.11).

**Diammonium tetraborate tetrahydrate**,  $(NH_4)_2O \cdot 2B_2O_3 \cdot 4H_2O$  or  $(NH_4)_2B_4O_7 \cdot 4H_2O$ , has a crystal density of 1.58 g/cm<sup>3</sup>. The solid is somewhat unstable, with an appreciable vapor pressure of ammonia at ambient pressure and temperature. It is crystallized from a solution of ammonium hydroxide and boric acid with a  $B_2O_3$ - $(NH_4)_2O$  molar ratio of about 2.0. Aqueous solutions up to 10% concentration have an invariant pH of 8.8. The crystal structure can be described by the formula  $(NH_4)_2B_4O_5 \cdot (OH)_4 \cdot 2H_2O$  [279].

**Other metal borates** are of comparatively smaller commercial volume. They are generally prepared by reacting an aqueous solution of boric acid or alkali metal borate with a metal oxide or soluble metal salt.

### 49.11.3 Zinc Borates

Several hydrates of zinc borate are known. These include  $2\text{ZnO} \cdot 3\text{B}_2\text{O}_3 \cdot 3.5\text{H}_2\text{O}$  or ZB 2335, which has a crystal density of  $2.69 \text{ g/cm}^3$  and thermal stability to dehydration up to  $290\text{--}300^\circ\text{C}$  [280]. It is made commercially from an aqueous boric acid solution with zinc oxide above  $70^\circ\text{C}$  in the presence of product zinc borate seed. An induction period of 1–2 h is followed by a highly exothermic reaction.

A zinc borate of composition  $2\text{ZnO} \cdot 3\text{B}_2\text{O}_3 \cdot 7$  to  $7.5\text{H}_2\text{O}$  or ZB 237, has a crystal density of  $2.44 \text{ g/cm}^3$ , and, from its X-ray structure, has the formula  $\text{Zn}[\text{B}_3\text{O}_3(\text{OH})_5] \cdot \text{H}_2\text{O}$  [281]. Six mol of water are lost when ZB 237 is heated from  $120$  to  $170^\circ\text{C}$ .

The nine hydrate,  $2\text{ZnO} \cdot 3\text{B}_2\text{O}_3 \cdot 9\text{H}_2\text{O}$  or ZB 239 is made using the same conditions as for ZB 2335 below  $70^\circ\text{C}$ .

The zinc borate,  $\text{ZnO} \cdot \text{B}_2\text{O}_3 \cdot 2\text{H}_2\text{O}$  or ZB 112, is thermally stable to dehydration up to  $190^\circ\text{C}$ . Several hydrated zinc borates are of commercial importance as fire retardant and smoke suppressant agents for polymers and coatings, most notably in PVC, halogenated polyesters, and nylon. For example, ZB 2335 is sold under the trade name Firebrake ZB or ZB 2335 (U.S. Borax & Chemical Corp., USA); it has a mean particle size of  $5\text{--}10 \mu\text{m}$ . Its high-thermal stability is an important physical property because of the high temperatures required in some plastic processing. The zinc borate ZB 112 is sold by Humphrey Chemical Co. (USA) and Storey Brothers (U.K.). In addition Humphrey sells zinc borates described as ZB 235 and ZB 237, which are prepared by dry mixing boric acid with zinc oxide. The resulting product is actually a mixture of zinc

borate  $2\text{ZnO} \cdot 3\text{B}_2\text{O}_3 \cdot 9\text{H}_2\text{O}$  or ZB 239 and unreacted starting materials.

### 49.12 Borate Glasses

Various alkali-metal oxides, when fused with boric oxide, form a viscous melt, which on supercooling readily forms glasses. Mixtures of alkali-metal borates, boric acid, and alkali-metal carbonates or hydroxides can be used. Many physical properties of these glasses have maxima and minima with increasing alkali-metal oxide to borate ratio. This has been termed the *boron anomaly*, and has been observed in such properties, as viscosity, density, thermal expansion, and heat content [264]. This anomaly has been shown to be a result of structural changes in the glass, and of the variation in proportion of tetrahedral coordination of the boron in  $\text{BO}_4$  groups and trigonal coordination in  $\text{BO}_3$  groups.

The viscosity of  $\text{Na}_2\text{O}\text{--}\text{B}_2\text{O}_3$  and  $\text{K}_2\text{O}\text{--}\text{B}_2\text{O}_3$  glass has a maximum value at  $20\text{--}25 \text{ mol}\%$  metal oxide below  $900^\circ\text{C}$  [282], and the density increases from  $1.85 \text{ g/cm}^3$  in pure  $\text{B}_2\text{O}_3$  to a maximum of  $2.36$  in mixtures containing  $27\text{--}33 \text{ mol}\%$  metal oxide at  $900^\circ\text{C}$  [283]. Maximum hardness is achieved with a composition of  $25\% \text{ Na}_2\text{O}$  [284]. Thermal expansion reaches a minimum up to about  $13 \text{ vol}\%$   $\text{Na}_2\text{O}$ . The index of refraction ( $n_D$ ) is  $1.48$  at  $6 \text{ vol}\%$   $\text{Na}_2\text{O}$ , and  $1.51$  at  $24 \text{ vol}\%$   $\text{Na}_2\text{O}$ .

Silica is quite soluble in molten sodium borate, giving a viscous liquid. The use of boric oxide in silica glass imparts many desirable properties. Borosilicate glass approaches the desirable properties of quartz glass, except the melting range and workability of the glass melt is significantly improved. Addition of boric oxide to alkali-metal silicate glass imparts increased hardness and decreased expansivity, lowers the melting range, and increases furnace production and durability of the glass. In ceramic glass,  $\text{B}_2\text{O}_3$  improves resistance to weathering and chemicals.

### 49.13 Miscellaneous Data for Sections 49.7–49.12

#### 49.13.1 Quality Specifications

Product specifications for boric oxide, boric acid, and borax are listed in Tables 49.14 and 49.15.

#### 49.13.2 Uses

The glass and ceramic industry in the United States consumes about one-half of the total domestic  $\text{B}_2\text{O}_3$ . This includes borosilicate glasses, insulation fiberglass, textile fiberglass, porcelain enamels, and ceramic glazes. The largest market is for insulation fiberglass, with typically  $5\text{--}7\%$  of contained  $\text{B}_2\text{O}_3$  from borax pentahydrate, ulexite, or probertite; whereas textile fiberglass typically has  $8\text{--}9\%$  of contained  $\text{B}_2\text{O}_3$  from boric acid or colemanite. Borosilicate glass has  $12\text{--}15\%$  of contained  $\text{B}_2\text{O}_3$  largely from borax pentahydrate. Borates are used as a flux in the manufacture of porcelain enamels and ceramic glazes. Of the total United States domestic  $\text{B}_2\text{O}_3$  consumption, about  $15\%$  is used in the form of boric acid and metal borates as fire retardants in cellulosic insulation and plastics;  $4\%$  as soluble borates in agriculture as a fertilizer to amend boron-deficient soils and as a herbicide at high dosages;  $10\%$  from borax decahydrate and sodium perborate for cleaning and bleaching of laundry products;

and  $2\%$  as corrosion inhibitors in aqueous systems, especially automotive antifreeze.

In Western Europe about one-half of the  $\text{B}_2\text{O}_3$  is used in the manufacture of glass-related products. Sodium perborate accounts for about one-third of the total boron consumption as a bleach in high-temperature laundry products.

In Japan  $70\%$  of  $\text{B}_2\text{O}_3$  consumption is used in glass-related products.

Other minor uses of boric acid and metal borates are listed below.

#### • Boric acid

- Flux in welding and brazing
- Bacteriostat and fungicide
- NF grade as a mild, nonirritating antiseptic
- Cockroach control
- Protection of wood products against insect damage
- Use in nuclear reactor cooling water
- Manufacture of refractories and abrasives
- Catalysts for air oxidation of hydrocarbons

Table 49.14: Specification for commercial  $\text{B}_2\text{O}_3$ .

|                         | % Maximum | % Typical |
|-------------------------|-----------|-----------|
| Na                      | 0.1       | 0.015     |
| $\text{SiO}_2$          | 0.21      | 0.15      |
| $\text{Al}_2\text{O}_3$ | 0.14      | 0.08      |
| $\text{Fe}_2\text{O}_3$ | 0.02      | 0.009     |
| CaO                     | 0.03      | 0.013     |
| MgO                     | 0.15      | 0.05      |
| $\text{SO}_4$           | 0.41      | < 0.20    |

Table 49.15: Maximum specifications for grades of boric acid, borax, and borax pentahydrate.

|   | Boric acid |                 | Borax     |                 | Borax pentahydrate |
|---|------------|-----------------|-----------|-----------------|--------------------|
|   | technical  | special quality | technical | special quality | technical          |
| $\text{H}_3\text{BO}_3\text{--Na}_2\text{B}_4\text{O}_7 \cdot 10\text{H}_2\text{O}$ | > 99.5     | > 99.9          | > 99.5    | > 99.9          |                    |
| $\text{SO}_4$   | 0.10       | 0.00015         | 0.06      | 0.0001          | 0.08               |
| $\text{PO}_4$   | —          | 0.001           | 0.001     | 0.001           | —                  |
| Cl  | 0.01       | 0.00004         | 0.07      | 0.00004         | 0.05               |
| $\text{Fe}_2\text{O}_3$   | 0.0007     | 0.0002          | 0.003     | 0.00028         | 0.004              |
| Heavy metals as Pb  | —          | 0.0002          | —         | 0.001           | —                  |
| Mn  | —          | 0.0001          | —         | —               | —                  |
| As  | —          | 0.0005          | —         | 0.0002          | —                  |
| Ca  | —          | 0.005           | —         | 0.005           | —                  |
| Na  | —          | 0.001           | —         | —               | —                  |
| Water insolubles  | —          | 0.001           | 0.02      | 0.001           | —                  |

- **Sodium borates, Calcium borates**
  - Manufacture of refractories and abrasives
  - Metallurgical flux (smelting)
  - Neutron absorber in nuclear reactors
- **Sodium metaborate**
  - Photographic chemical
  - Herbicides
  - Detergents and cleansers
  - Textile-finishing compounds
  - Adhesives
- **Potassium borates**
  - Nonsodium alkaline borate source
  - Lubricant component
  - Solvent for casein
  - Welding and brazing flux for stainless steels and various nonferrous metals
- **Ammonium tetraborate**
  - Nonalkaline metal borate source
- **Ammonium pentaborate**
  - Component in electrolytes for electrolytic capacitors
  - Flameproofing formulations
  - Paper coating
- **Lithium meta- and tetraborates**
  - Glass-making
- **Barium borates**
  - Fire retardants
  - Mildew inhibitor in latex, paints, plastics, textile, and paper products
  - Preservative in protein-based glues
- **Copper metaborate**
  - Rot and mildew inhibitor
  - Fungicide in lumber and other cellulosic materials
  - Oil pigment
- **Manganese borate**
  - Printing ink drier

### 49.13.3 Economic Aspects

The estimated world reserves of borate minerals and world production of boron products for 1980 through 1982 are listed in Table

49.16. Of the total world borates the United States produces 62%, Turkey 29%, and all other sources 9%, based on  $B_2O_3$ . World borate consumption in the United States is 30%, Western Europe 37%, Japan 5%, and all other countries 28%. The European and Japanese borate requirements are served through imports largely from the United States and Turkey. Almost all  $B_2O_3$  production in Turkey and about one-half the production in the United States is exported.

Nearly 99% of the sales volume of borate products consists of borax pentahydrate, borax decahydrate, boric acid, boric oxide, anhydrous borax, colemanite, and ulexite. Borax pentahydrate is the highest volume commercial borate.

Until mid-1984, U.S. Borax exported a crude borax pentahydrate, trade name Rasorite-46, containing less than 1% clay. This product is now exported without clay as borax pentahydrate. Prices of the primary borate products are shown in Table 49.17.

Table 49.16: Estimated world borate reserves and mine production (as  $B_2O_3$ ).

| Country       | Reserves, kt | Production, kt |      |      |
|---------------|--------------|----------------|------|------|
|               |              | 1980           | 1981 | 1982 |
| United States | 70 000       | 710            | 670  | 550  |
| Turkey        | 70 000       | 339            | 320  | 320  |
| South America | 35 000       | —              | —    | —    |
| Argentina     | —            | —              | 30   | 27   |
| Chile         | —            | —              | 1    | 4    |
| Peru          | —            | —              | 3    | 3    |
| Soviet Union  | 65 000       | —              | 40   | 40   |
| China         | 30 000       | —              | 5    | 5    |
| World total   | 270 000      | 1049           | 1069 | 949  |

Table 49.17: Borate prices [285].

| Product   | \$/t                 |
|---|----------------------|
| Borax, decahydrate, technical, granular, 99.5%, bulk carlots  | 193 <sup>a</sup>     |
| Borax, pentahydrate, technical, granular, 99.5%, bulk carlots | 222 <sup>a</sup>     |
| Borax, anhydrous, technical, 99%, bulk carlots                | 622 <sup>a</sup>     |
| Boric acid, technical, granular, 99.9%, bulk carlots          | 609 <sup>a</sup>     |
| Tincal  | 148–185 <sup>b</sup> |
| Ulexite   | 120–170 <sup>b</sup> |
| Colemanite, glass quality                                     | 255–325 <sup>b</sup> |
| Colemanite, refining grade                                    | 160–190 <sup>b</sup> |

<sup>a</sup>FOB (free on board) rail cars in California, United States.

<sup>b</sup>FOB ship Bandirma, Turkey.

There has been a significant decline in production of anhydrous products because of the rapid increase in fuel costs. In addition there is a trend to use colemanite for the manufacture of textile fiberglass.

### 49.13.4 Toxicology and Occupational Health

Boron is present in animal tissue at about 1 ppm, but has no known essential biochemical function [286]. Humans absorb about 10–20 mg of boron in a normal daily diet, mainly from fruits and vegetables. Inhalation of boric acid and borate dust causes only irritation without permanent injury. It is not absorbed when contacted with healthy skin, but can be toxic when used on large areas of burned or abraded skin. The handling of boric acid and sodium borates is not generally considered hazardous [289].

Boric acid has an acute oral  $LD_{50}$  (rats) of 4 g/kg; for borax the oral  $LD_{50}$  (rats) is 6 g/kg. The TLV and MAK data are given in Table 49.18 [287, 288].

Boron is an essential trace element in higher plant nutrition [290]. At high levels boron becomes toxic, with damage manifested in deformation of leaves, which curl at the edge, often accompanied by necrosis. Fertilizers with calcium tend to reduce this damage [254].

Table 49.18: Maximum concentrations in the work environment.

| Substance           | TWA,<br>mg/m <sup>3</sup> | STEL,<br>mg/m <sup>3</sup> | MAK,<br>mg/m <sup>3</sup> |
|---------------------|---------------------------|----------------------------|---------------------------|
| Sodium tetraborates |                           |                            |                           |
| Anhydrous           | 1                         | —                          | —                         |
| Decahydrate         | 5                         | —                          | —                         |
| Pentahydrate        | 1                         | —                          | —                         |
| Boron oxide         | 10                        | 20                         | 15                        |

## 49.14 Pigments

### 49.14.1 Borosilicate Pigments

Borosilicate pigments usually contain calcium or zinc ions in a matrix of silicon dioxide and boron trioxide,  $x(Ca, Zn) \cdot ySiO_4 \cdot zBO_3$ .

Aqueous slurries of this white pigment are alkaline (pH > 9). Borosilicate pigments are recommended as nontoxic alternatives to basic lead silicate. Their main field of application is in waterborne binders and electrodeposition coatings [291–293].

A trade name for calcium borosilicate is Halox CW291, -2230 (Halox Pigments, USA).

### 49.14.2 Borate Pigments

Barium metaborate,  $BaO \cdot B_2O_3 \cdot H_2O$  [294], and zinc borophosphate,  $ZnO \cdot xB_2O_3 \cdot yP_2O_5 \cdot 2H_2O$ , are colorless pigments. Their properties are listed in Table 49.19. They both have a relatively high water solubility. Barium metaborate is coated with silica to reduce this.

Table 49.19: Properties of metal borate pigments.

| Property                   | Barium metaborate | Zinc borophosphate |
|----------------------------|-------------------|--------------------|
| Density, g/cm <sup>3</sup> | ca. 3.3           | 2.8                |
| pH                         | 9–10              | 8                  |
| Water-soluble content, %   | 0.4               | 1–1.5              |
| Use                        | primer, topcoat   | primer             |

The anticorrosive effects of these pigments depend mainly on their ability to maintain high pH values in the coating. They are most effective in the initial phase of corrosion protection. The borate ion neutralizes acidic foreign ions and binder decomposition products, but is also thought to act as an anodic passivator, forming a protective film. The effectiveness of metal borate pigments in aqueous air-dried anticorrosive coatings is described in [295].

The metal borate pigments are classified as having a relatively low toxicity [296, 297].

Examples of trade names are Butrol (Buckmann Laboratories, USA) for barium metaborate and Sidor BZN (BASF, Germany) for zinc borophosphate.

## 49.15 References

1. V. I. Matkovich (ed.): *Boron and Refractory Borides*, Springer Verlag, Berlin 1977.



2. R. M. Adams: *Boron, Metallo-Boron Compounds and Boranes*, J. Wiley & Sons, New York 1964.
3. R. F. Gould (ed.): "Borax to Boranes", *Adv. Chem. Ser.* 1961, no. 32, pp. 27-52.
4. *Gmelin*, Boron (system no. 13), main vol. (1926), supplement vol. (1954), supplement vol. 2 (1981).
5. N. N. Greenwood: "Boron", in J. C. Bailar (ed.): *Comprehensive Inorganic Chemistry*, vol. 1, Pergamon Press, Oxford-New York 1973, pp. 680-689.
6. R. Naslain in P. Hagemuller (ed.): *Preparative Methods in Solid State Chemistry*, Academic Press, New York 1972, pp. 439-485.
7. A. F. Zhigach, D. C. Stasinevich: "Methods of Preparation of Amorphous Boron", in V. I. Matkovich (ed.): *Boron and Refractory Borides*, Springer Verlag, Berlin 1977, pp. 214-240.
8. H. S. Cooper: "Boron", in C. A. Hampel (ed.): *Rare Metals Handbook*, 2nd ed., Reinhold Publ. Co., London 1961, p. 77.
9. B. Mason: *Principles of Geochemistry*, John Wiley & Sons, New York 1952, p. 41.
10. H. Moissan, *Ann. Chim. Phys.* 6 (1895) 296.
11. E. Weintraub, *Trans. Am. Electrochem. Soc.* 16 (1909) 165.
12. R. C. Erd: *Supplement to Mellor's Comprehensive Treatise on Inorganic and Theoretical Chemistry*, vol. 5, Longman, New York 1980, Part A, Section A1, p. 7.
13. T. Dickson, *Ind. Miner. (London)* 12 (1983) 63.
14. K. P. Tsomaya et al., *J. Less Common Met.* 47 (1976) 249.
15. J. Cueilieron, *Ann. Chim.* 19 (1944) 459.
16. Y. Hara et al., *Kenkyu Hokoku Asahi Garasu Kogyo Gijutsu Shoreikai* 26 (1975) 255; *Chem. Abstr.* 87 (1977) 44 716 p.
17. G. Wilkinson (ed.): *Comprehensive Organometallic Chemistry*, vol. 1 pp. 253-554, vol. 7, pp. 111-364, Pergamon Press, Oxford 1982.
18. L. Bretherick (ed.): *Hazards in the Chemical Laboratory*, 3rd ed., Royal Society of Chemistry, London 1981, p. 203.
19. J. Cueilieron, F. Thevenot: "Chemical Properties of Boron", in V. I. Matkovich (ed.): *Boron and Refractory Borides*, Springer Verlag, Berlin 1977, pp. 203-211.
20. L. Vandenbulcke, G. Vuillard, *J. Less Common Met.* 67 (1979) 65.
21. D. Z. Hobbs, T. T. Campbell, F. E. Block, *Rep. Invest. U.S. Bur. Mines* 6456 (1964) 1-14.
22. B. I. Silbergleit et al., SU 1004262, 1981.
23. J. C. Schuhmacher, US 3 001855, 1961.
24. H. Mazza et al., US 2866688, 1958.
25. W. J. Kroll, N. P. Nies, E. W. Fajans, US 2893842, 1959.
26. J. Yannacakis, N. P. Nies, *Boron Synth. Struct. Prop. Proc. Conf.* 1959 1960, 38-41.
27. L. Markovskii, *Electron Technol.* 3 (1970) 95.
28. H. C. Starck, GB 747287, 1956 (H. Haag).  
F. Müller, H. Haag, DE 936745, 1955.  
H. Haag, DE 957299, 1957; US 2794708, 1957.
29. R. Naslain, *Inorg. Synth.* 12 (1970) 145.
30. T. Sugaya et al., *J. Less Common Met.* 47 (1976) 49.
31. H. J. Becher: "Boron", in G. Brauer (ed.): *Handbuch der Präp. Anorg. Chemie*, 3rd ed., vol. 2, Enke Verlag, Stuttgart 1978, pp. 787-788.
32. G. H. Fetterly, US 2542916, 1951.
33. D. Stern, L. Lynds, *J. Electrochem. Soc.* 105 (1958) 676.
34. A. J. Laubengayer et al., *J. Am. Chem. Soc.* 65 (1943) 1924.
35. Elektroschmelzwerk Kempton, DE 2115810, 1982 (G. Wiebke et al.).
36. J. Cueilieron, J. C. Viala, *J. Less Common Met.* 65 (1979) 167.
37. J. Cueilieron, J. Viala, *J. Less Common Met.* 67 (1979) 333.
38. A. van Arkel, US 1774410, 1930; *Metallwirtsch. Metallwiss. Metalltech.* 13 (1934) 405.
39. H. Schlesinger, G. W. Schaeffer, US 2528514, 1950.
40. J. Lagrenaudie, *J. Chem. Phys.* 50 (1953) 629.
41. W. H. Dietz, H. A. Herrmann, *Electron Technol.* 3 (1970) 195.
42. N. P. Nies, *J. Electrochem. Soc.* 107 (1960) 817.
43. W. Borchert et al., *Z. Angew. Phys.* 29 (1970) 277.
44. G. V. Tsagareishvili et al., *J. Less Common Met.* 67 (1979) 419.
45. F. Thevenot, J. Cueilieron, *Analisis* 5 (1977) 105; *Met. Abstr.* 1977, 23-0637.
46. F. Ehrenberger, *Fresenius Z. Anal. Chem.* 305 (1981) 181.
47. F. Thevenot, J. C. Viala, *Analisis* 3 (1975) 76.
48. Military Specification MIL-B-51092/ORD (1962).
49. Degussa, Research Dept. Phys. Chem., internal measurements (1983).
50. S. Moeschlin: *Klinik und Therapie der Vergiftungen*, Thieme Verlag, Stuttgart 1980, pp. 206-208.
51. R. J. Markle, S. G. Stephenson, *Int. J. Powder Metall. Powder Technol.* 18 (1982) 243.
52. W. C. Goss, US 2415946, 1947.
53. *Winnacker-Küchler*, 4th ed., vol. 3, pp. 408-440.
54. G. K. Gaulé et al., *Boron Prep. Prop. Appl. Pap. Int. Symp. 1964 2* (1965) 317-338.
55. G. F. Girri et al., *3rd Int. Conf. Thin Films*, Budapest 1975, p. 215; *Met. Abstr.* 1976, 63-0163.
56. J. T. Milek, S. J. Wellers, *Boron*, Electronic Prop. Inf. Center, Hughes Aircraft Co., Culver City, Calif., Data Sheet DS 151 (1967).
57. J. L. Christian et al., *Met. Prog.* 97 (1970) 113.
58. G. Lubin, S. Dastin, *Mod. Plast.* 48 (1971) 62.
59. D. Kuehl, *Nat. SAMPE Symp. Exhib. Proc.* 20 (1975) 67; *Met. Abstr.* 1975, 61 0384.
60. M. Miller, A. Robertson, *Hybrid Sel. Met. Matrix Compos.* 1977, 99-157; *Met. Abstr.* 1979, 62-0211.
61. *Kirk-Othmer*, 3rd ed., vol. 16, p. 163.
62. *Met. Abstr.* 1981, 46-0040.
63. *Kirk-Othmer*, 3rd ed., vol. 2, pp. 537-569.
64. H. P. Munster, G. Kirchner: *Taschenbuch des Metallhandels*, Metall Verlag, Berlin 1982, pp. 151-153.
65. *Gmelin*, vol. 34, sect. 1 & 9, 332 pp.
66. *Gmelin*, vol. 53, sect. 2 & 19, 341 pp.
67. *Gmelin*, vol. 2(1), pp. 255-316.
68. *Gmelin*, vol. 2(2), pp. 1-154.
69. N. N. Greenwood, B. S. Thomas in J. C. Bailar (eds.): *Comprehensive Inorganic Chemistry*, vol. 1, Pergamon Press, Oxford 1973, p. 956.
70. G. Urry in E. Muettterties (ed.): *The Chemistry of Boron and Its Compounds*, J. Wiley & Sons, Inc., New York 1967, pp. 325-375.
71. J. D. Cox, *J. Chem. Thermodyn.* 10 (1978) 903-906.
72. A. Finch, P. J. Gardiner in R. J. Brotherlon, H. Steinberg (eds.): *Progress in Boron Chemistry*, vol. 3, Pergamon Press, New York 1970, p. 200.
73. E. W. Rothe, B. P. Mathur, G. P. Reck, *Inorg. Chem.* 19 (1980) 829-831.
74. D. Mootz, M. Steffen, *Angew. Chem.* 92 (1980) 481; *Angew. Chem. Int. Ed. Engl.* 19 (1980) 483-484.
75. D. Mootz, M. Steffen, *Acta Crystallogr. Sect. B*, B37 (1981) 1110.
76. J. L. Gay-Lussac, L. J. Thenard, *Ann. Chim. (Paris)* 69 (1809) no. 1, 204-220.
77. B. Zawadzki, A. Bulinska, E. Wilk, *Mater. Ogolnopol. Symp. Związki Fluorowe 1980* (Publ. 1981) 113-117.  
*Chem. Abstr.* 95 (1981) 189416.
78. Kerr-McGee Chemical Corp., US 4125590, 1978 (L. F. Schmoyer).
79. Alcoa, US 4024221, 1977 (A. J. Becker, D. R. Caretti).
80. PPG Industries, Inc., US 4210631, 1980 (N. R. DeLue, J. C. Crano).
81. PPG Industries, Inc., US4213948, 1980 (J. C. Crano).
82. H. Kral, DE 2826747, 1980.  
*Chem. Abstr.* 92 (1980) 113123.
83. V. S. Khain, V. P. Val'kova, E. S. Kotelevets, *Zh. Neorg. Khim.* 22 (1977) 338.
84. J. Cueilieron, S. C. Viala, *J. Less Common Met.* 58 (1978) 123.  
*Chem. Abstr.* 89 (1978) 15952.
85. Showa Koji K. K., JP-Kokai 7768754, 1977 (H. Yasutomi, N. Takeshima, T. Matsuno, H. Momo).  
*Chem. Abstr.* 87 (1977) 206078.
86. Morita Kagaku Kogyo Co. Ltd., JP-Kokai 7896260, 1978 (T. Tatsuno, K. Momota).  
*Chem. Abstr.* 90 (1979) 11870.
87. Asahi Glass Co. Ltd., JP-Kokai 8047119, 1980 (M. Noshiro, T. Yaritha, S. Kobayashi).  
*Chem. Abstr.* 94 (1981) 7204.
88. E. H. Vernet, J. D. MacEwen, C. C. Haun, E. R. Kinkead, *Toxicol. Appl. Pharmacol.* 42 (1977) 417-423.  
*Chem. Abstr.* 88 (1978) 84173.
89. H. S. Booth, D. R. Martin: *Boron Trifluoride and Its Derivatives*, J. Wiley & Sons, New York, p. 87.
90. D. W. A. Sharpe in M. Stacey, J. C. Tatlow, A. G. Sharpe (eds.): *Advances in Fluorine Chemistry*, vol. 1, Butterworths Scientific Publications, London 1960, p. 68.
91. *Gmelin*, vol. 2(1), p. 276.
92. *Gmelin*, vol. 2(2), p. 31.
93. R. M. Adams, *Pure Appl. Chem.* 30 (1972) 683.
94. D. Mootz, M. Steffen, *Z. Anorg. Allg. Chem.* 482 (1981) 193.
95. N. V. Krivtsov, K. V. Titova, V. Ya. Rosolovskii, *Zh. Neorg. Khim.* 22 (1977) 679.
96. R. Wilmotte, J. Benezech, *Galvano-Organos* 45 (1976) 313.
97. C. J. Hill, R. P. Lash, *Anal. Chem.* 52 (1980) 24.
98. J. P. Wilshire, W. A. Brown, *Anal. Chem.* 54 (1980) 1647.
99. United States Steel Corp., US 3933605, 1976 (T. J. Butler, R. M. Hudson, C. J. Warning).
100. RCA Corp., US 3979238, 1976 (H. W. Justice).
101. Rockwell International Corp., US 4004957, 1977 (L. J. Quintana).
102. Y. Nakao, H. Nakeshima, M. Ohta, K. Furukawa, *J. Nucl. Sci. Technol.* 15 (1978) 76.  
*Chem. Abstr.* 88 (1978) 96218.
103. United States of America, US 4207124, 1980 (K. O. Christe).
104. Morita Chemical Industry Co., Ltd., JP-Kokai 76116060, 1976 (Y. Mochida, T. Tatsuno).  
*Chem. Abstr.* 87 (1977) 90347.
105. Dart Industries, Inc., US 4008162, 1977 (T. F. Korenowski, J. L. Penland, C. J. Ritzert).
106. Showa Koji K. K., JP-Kokai 7692561, 1976 (H. Yasutomi, N. Takeshima, T. Matsuno, H. Momo).  
*Chem. Abstr.* 85 (1976) 166268.
107. Nitto Electric Industrial Co., Ltd., JP-Kokai 82162692, 1982.  
*Chem. Abstr.* 98 (1983) 59412.
108. P. Langer, H. Kokesova, K. Gschwendtova, *Acta Endocrin. Copenhagen* 81 (1976) 516.  
*Chem. Abstr.* 85 (1976) 40748.
109. M. W. Curtis, C. H. Ward, *J. Hydrol. (Amsterdam)* 51 (1981) 359.  
*Chem. Abstr.* 95 (1981) 55868.
110. E. L. Muettterties: *The Chemistry of Boron and Its Compounds*, J. Wiley & Sons, New York 1967, pp. 647-667.
111. H.-Y. Chen, B. R. Conard, P. W. Gilles, *Inorg. Chem.* 9 (1970) 1776-1777.
112. H. Diercks, B. Krebs, *Angew. Chem.* 89 (1977) no. 5, 327; *Angew. Chem., Int. Ed. Engl.* 16 (1977) no. 5, 313.
113. E. G. Zhukhov, S. A. Dembovski, *Izv. Akad. Nauk SSSR Neorg. Mater.* 16 (1980) 37-41.  
*Chem. Abstr.* 92 (1980) 117432.
114. M. P. Morozova, G. A. Rybakova, *Vestn. Leningr. Univ., Fiz., Khim.* 23 (1968) no. 22, 161-163.  
*Chem. Abstr.* 71 (1969) 7162.
115. N. N. Greenwood, B. S. Thomas in J. C. Bailar (ed.): *Comprehensive Inorganic Chemistry*, vol. 1, Pergamon Press, New York 1973, pp. 909-916.
116. B. Krebs, H. U. Huerter, *Angew. Chem.* 92 (1980) 479; *Angew. Chem., Int. Ed. Engl.* 19 (1980) 481-482.
117. H.-Y. Chen, P. W. Gilles, *J. Am. Chem. Soc.* 92 (1970) 2309-2312.
118. J. H. Holloway, D. C. Puddick, G. M. Staunton, D. Brown, *Inorg. Chim. Acta* 64 (1982) L209-L210.
119. R. R. Schumaker, E. M. Engler, *J. Am. Chem. Soc.* 99 (1977) 5521-5522.
120. K. P. Callahan, P. J. Durand, *Inorg. Chem.* 19 (1980) 3211-3217.
121. R. D. Baechler, S. K. Daley, *Tetrahedron Lett.* 1978, no. 2, 101-104.
122. E. R. Squibb & Sons, Inc., US 4018761, 1977 (C. M. Cimarusi, P. Wojtkowski, J. E. Dolfini).
123. A. Levasseur, R. Olazuaga, M. Kbalá, M. Zahir et al., *C.R. Séances Acad. Sci. Sér. 2* 293 (1981) 563-565.  
*Chem. Abstr.* 96 (1982) 186016.
124. H. Wada, M. Menetrier, A. Levasseur, P. Hagemuller, *Mater. Res. Bull.* 18 (1983) no. 2, 189-193.
125. S. Susman, L. Boehm, K. J. Volin, C. J. Delbecq, US Appl. 3755257 1983.  
*Chem. Abstr.* 100 (1984) 124156.

126. S. Susman, L. Boehm, K. J. Volin, C. J. Delbecq, *Solid State Ionics* 5 (1981) 667-669.
127. A. Stock: *Hydrides of Boron and Silicon*, Cornell University Press, Ithaca, New York 1933.
128. H. I. Schlesinger, A. B. Burg, *J. Am. Chem. Soc.* 53 (1931) 4321.
129. H. C. Brown: *Hydroboration*, W. A. Benjamin Inc., New York 1962.
130. W. N. Lipscomb, *Science* 196 (1977) 1047.
131. W. N. Lipscomb, *Adv. Inorg. Chem. Radiochem.* 1 (1959) 156.
132. *Pure Appl. Chem.* 30 (1972) 683.  
R. M. Adams, *Inorg. Chem.* 7 (1968) 1945.  
J. B. Casey, W. J. Evans, W. H. Powell, *Inorg. Chem.* 22 (1983) 2245.
133. T. P. Fehlner, R. L. Strong, *J. Phys. Chem.* 64 (1960) 1526.
134. R. F. Porter, F. A. Grimm, *Adv. Chem. Ser.* 72 (1969) 100.  
*Chem. Abstr.* 68 (1968) 110276.
135. M. D. Carabine, R. G. W. Norrish, *Proc. R. Soc. (London), Ser. A* 296 (1967) 1.
136. A. E. Newkirk, H. R. Broadly, A. L. Marshall, General Electric Co. Report No. 55 248, March 20, 1950.
137. R. W. Parry, L. J. Edwards, *J. Am. Chem. Soc.* 81 (1959) 3560.
138. E. Muettterties (ed.): *Boron Hydride Chemistry*, Academic Press Inc., New York 1975, Chapter 3.
139. G. A. Guter, G. W. Schaeffer, *J. Am. Chem. Soc.* 78 (1956) 3546.
140. M. F. Hawthorne et al., *J. Am. Chem. Soc.* 82 (1960) 1825.
141. H. D. Johnson, II, S. G. Shore, *J. Am. Chem. Soc.* 93 (1971) 3798.
142. Callery Chemical Co., *Diborane Handling Bulletin*, 1982.
143. A. Stock, C. Massenz, *Ber. Dtsch. Chem. Ges.* 45 (1912) 3539.
144. E. Wiberg, K. Schuster, *Ber. Dtsch. Chem. Ges.* 67B (1934) 1807.
145. V. I. Mikheeva, V. Y. Markina, *Zh. Neorg. Khim.* 1 (1956) 619.
146. M. J. Klein, B. C. Harrison, I. Solomon, *Abstr. 131st ACS Meeting*, Miami, FL, April, 1957.
147. C. R. Dillard, Ph.D. Thesis, University of Chicago, 1949.
148. H. C. Brown, W. Korytnik, *J. Am. Chem. Soc.* 82 (1960) 3869.
149. S. Ikegami, S. Yamada, *Chem. Pharm. Bull. (Tokyo)* 14 (1966) no. 12, 1399.  
*Chem. Abstr.* 66 (1967) 65377.
150. R. L. Johnson, D. J. Burton, *Tetrahedron Lett.* 1965, no. 46, 4039-4084.
151. H. Ikeda, A. Kogure, K. Shuna, Y. Minoura, *Kogyo Kagaku Zasshi* 68 (1965) 1107.  
*Chem. Abstr.* 66 (1965) 56346.
152. E. M. Fedneva, V. N. Konoplev, V. D. Krosnaperova, *Zh. Neorg. Khim.* 11 (1966) 2051.  
*Chem. Abstr.* 66 (1967) 28367.
153. R. M. Adams: *Boron Metallo-Boron Compounds and Boranes*, Interscience, New York 1964, p. 249.
154. R. Ewens, H. Bassett, *Chem. Ind. (London)* 68 (Feb., 1949) 131.
155. A. P. Altschuler, *J. Am. Chem. Soc.* 77 (1955) 5455.
156. Metal Hydrides, US 2970114, 1961 (R. W. Bragdon).
157. Mine Safety Appliances, US 2744810, 1956 (C. B. Jackson).
158. Callery Chemical Co., GB 774728, 1957 (W. H. Schecter).
159. A. E. Finhold, A. C. Bond, Jr., H. I. Schlesinger, *J. Am. Chem. Soc.* 69 (1947) 1199.
160. Ventron Div., Morton-Thiokol Inc., DE 1218413, 1959; DE 2429521, 1974 (E. R. Winiarczyk).
161. M. M. Cook, E. A. Sullivan, R. C. Wade: *13th Northeast Regional ACS Meeting*, Hartford, CT, June, 1983.
162. D. F. Gaines, R. Schaeffer, F. Tebbe, *Inorg. Chem.* 2 (1963) 526.
163. H. C. Miller, N. E. Miller, E. L. Muettterties, *J. Am. Chem. Soc.* 85 (1963) 3885.  
*Inorg. Chem.* 3 (1964) 1456.
164. G. S. Pauson, L. E. Weill, *J. Inorg. Nucl. Chem.* 15 (1960) 184.
165. R. O. Hutchins, N. R. Natale, *Org. Prep. Proced. Int.* 11 (1979) 246.
166. Ventron Div., Morton-Thiokol Inc., US 2942990, 1960 (E. A. Sullivan).
167. Ventron Div., Morton-Thiokol Inc., US 2930771, 1960 (R. C. Wade).
168. E. A. Sullivan: *Third International Meeting on Boron Chemistry*, Munich and Ettal (FRG), July 5-9, 1976, Pergamon Press, Oxford 1977, p. 132.
169. GAF Corp., US 3306886, 1967 (F. Grosser, E. V. Hart, A. Schwartz).
170. Union Carbide, US 3374121, 1968 (J. N. Hgsett).
171. Eastman Kodak, FR 1548122, 1968 (C. C. Bard, H. W. Vogt).
172. W. Boden, *J. Electrochem. Soc.* 129 (1982) 1252.
173. H. Hatanka, *J. Neurol.* 209 (1975) 81.
174. W. Kliegel: *Bor In Biologie, Medizin und Pharmazie*, Springer Verlag, Berlin 1980, pp. 636-803.
175. G. D. Clayton, F. E. Clayton (ed.): *Patty's Industrial Hygiene and Toxicology*, J. Wiley & Sons, New York 1981, pp. 2978-3005.
176. R. L. Tatken, R. J. Lewis, Sr.: *Registry of Toxic Effects of Chemical Substances*, vols. 1, 2, 3, U.S. Dept. of Health and Human Services, NIOSH Publ. No. 83-107, 1981-1982.
177. C. C. Comstock, L. Feinsilver, L. H. Lawson, F. W. Oberst, Army Chemical Corps Medical Laboratories, Research Report No. 258, 1954.
178. ACGIH (ed.): *Threshold Limit Values (TLV)*, ACGIH, Cincinnati, OH, 1985.
179. DFG (ed): *Maximale Arbeitsplatzkonzentrationen*, Verlag Chemie, Weinheim 1984.
180. E. M. Cordasco, R. W. Cooper, J. V. Murphy, C. Anderson, *Chest* 41 (1962) 68.
181. H. J. Lowe, G. Freeman, *AMA Arch. Ind. Health* 16 (1957) 523.
182. E. H. Krackow, *AMA Arch. of Ind. Hyg. Occup. Med.* 8 (1953) 335.
183. R. M. Adams: *Boron, Metallo-Boron Compounds and Boranes*, Interscience, p. 731, New York 1964.
184. L. H. Hall, C. O. Starnes et al., *J. Pharm. Sci.* 69 (1980) 1025.
185. C. T. Blaisdell, Army Chemical Corps Medical Laboratories, Research Report no. 351, 1955.

186. W. E. Reinhart, *Am. Ind. Hyg. Assoc. J.* 21 (1960) 389.
187. R. A. Spryshkova, L. I. Karaseva, V. A. Bratsev, N. G. Serebryakov, *Med. Radiol. (Mosk.)* 26 (1981) 62.  
*Chem. Abstr.* 95 (1981) 108411.
188. R. Kieffer, F. Benesovsky: *Hartstoffe*, Springer Verlag, Wien-New York 1963.
189. R. A. Murgatroyd, B. T. Kelly, *At. Energy Rev.* 15 (1977) 3-74.
190. V. I. Matkovich: *Boron and Refractory Borides*, Springer Verlag, Berlin-Heidelberg-New York 1977.
191. K. A. Schwetz, K. Reinmuth, A. Lipp, *Radex Rundsch.* 1981, no. 3, 568-585.
192. K. Reinmuth, A. Lipp, H. Knoch, K. A. Schwetz, "Bohaltige, keramische Neutronenabsorberwerkstoffe", *J. Nucl. Mater.* 124 (1984) 175-184.
193. K. A. Schwetz, A. Lipp, *ATW Atomwirtsch. Atomtech.* 18 (1973) 531.
194. H. Moissan: *Der elektrische Ofen*, Verlag M. Kroyer, Berlin 1900.
195. J. L. Hoard, R. E. Hughes in E. L. Muettterties (ed.): *The Chemistry of Boron and Its Compounds*, J. Wiley & Sons, New York 1967, pp. 22-154.
196. T. Lundström, *Ark. Kemi* 31 (1969) 227-266.
197. H. Nowotny in L. E. J. Roberts (ed.): *Solid State Chemistry*, vol. 10, Butterworths, London 1972, pp. 151-188.
198. E. Rudy, *Tech. Rep. AFML-TR 652*, Part V. Compendium of Phase Diagram Data (1969).
199. K. E. Spear: *Phase Diagrams*, vol. IV, Materials Science and Technology, Academic Press, New York 1976, pp. 91-159.
200. G. V. Samsonov, T. I. Serebryakova, V. A. Neronov, *Boridy (Borides)*, Atomizdat Publ., Moscow 1975.
201. R. Thompson in J. Brotherton, H. Steinberg (eds.): *Progress in Boron Chemistry*, vol. 2, Pergamon Press, Oxford 1971, pp. 173-230.
202. F. Binder, *Radex Rundsch.* 1975, no. 4, 531-557; 1977, no. 1, 52-71.
203. H. Pastor, F. Thevenot, *Inf. Chim.* 178 (1978) 151-173.
204. R. Kiessling, *Acta Chem. Scand.* 4 (1950) 209.
205. K. A. Schwetz, Thesis, Technical University, Vienna 1971.
206. F. Thevenot, J. Cueilieron, *Analysis* 5 (1977) 105-121.
207. PPG, DE-OS 2523423, 1975.
208. PPG, DE-OS 2818418, 1978 (R. R. May, Jr.).
209. H. Pastor in [190], pp. 457-493.
210. ESK GmbH, DE-OS 3301841, 1984.
211. E. Fitzer, *Arch. Eisenhüttenwes.* 44 (1973) no. 9, 703-709.
212. R. D. Holliday, R. Mogstad, J. L. Henry, *Electrochem. Technol.* 1 (1963) 183-190.
213. S. K. Dutta, G. E. Gazza, *Bull. Am. Ceram. Soc.* 52 (1973) 552-554.
214. F. Rigby: "Development of Hot Pressing Techniques at Springfield Nuclear Laboratories", *Spec. Ceram.* 7 (1981) 249-258.
215. K. Hunold, *CFI Ceram. Forum Int.* 60 (1983) 182-189.
216. W. Grellner, K. A. Schwetz, A. Lipp, *Radex Rundsch.* 1983, no. 1/2, 146-151.
217. Aluminum Corporation of America, US 4071420, 1978.
218. C. E. Ransley, *J. Met.* 14 (1963) 129.
219. ESK GmbH, DE 2240655, 1972.
220. K. S. S. Murthy, *Br. Foundryman* 67 (1974) 335.
221. ESK GmbH, US 4118256, 1976.
222. K. G. Schmitt-Thomas, H. Meisel, S. Mirdamadi-Therani, *Metall (Berlin)* 32 (1978) 1103.
223. O. Knotek, E. Lugscheider, H. Eschnauer: *Hartlegierungen zum Verschleißschutz*, Verlag Stahleisen, Düsseldorf 1975.
224. G. V. Samsonov, Yu. B. Paderno, V. S. Fomenko, *Sov. Powder Metall. Met. Ceram. (Engl. Transl.)* 6 (1963) 24.
225. M. Futamoto, M. Nakazawa, U. Kawabe, *Surf. Sci.* 100 (1980) 470-480.
226. F. Dachille, R. Roy, *J. Am. Ceram. Soc.* 42 (1959) 78.  
J. D. Mackenzie, W. F. Claussen, *J. Am. Ceram. Soc.* 44 (1961) 79.
227. D. White, D. E. Mann, P. N. Walsh, A. Sommer, *J. Chem. Phys.* 32 (1960) 481, 488.  
H. J. Emeleus, A. G. Sharpe: *Advances in Inorganic Chemistry and Radiochemistry*, vol. 5, Academic Press, New York 1963.
228. P. Wulff, S. K. Majumdar, *Z. Phys. Chem.* B31 (1936) 319.
229. H. Menzel, H. Schultz, *Z. Anorg. Chem.* 245 (1940) 157.
230. A. Cousen, W. E. S. Turner, *J. Chem. Soc.* 1928, 2654.
231. E. J. Prosen, W. H. Johnson, F. Y. Pargiel, *J. Res. Nat. Bur. Stand.* 62 (1959) 43.  
*Chem. Abstr.* 53 (1959) 15746.
232. W. F. Claussen, J. D. Mackenzie, *J. Am. Chem. Soc.* 81 (1959) 1007.
233. S. T. Benson, G. S. Parks, *J. Phys. Chem.* 35 (1931) 2091.
234. A. Buechler, J. B. Berkovitz-Mattuk, *J. Chem. Phys.* 39 (1963) 286.
235. D. L. Hildebrand, W. F. Hall, N. D. Potter, *J. Chem. Phys.* 39 (1963) 296.
236. K. Yu. Kazema, A. K. Lindpere, L. A. Luts, *Tr. Inst. Fiz. Astron. Akad. Nauk Est. SSR* 7 (1958) 34.  
*Chem. Abstr.* 54 (1960) 19188.
237. F. T. Greene, J. L. Margrane, *J. Phys. Chem.* 70 (1966) 2112.
238. J. Dulat in [12], Section A4, p. 186.
239. J. C. Southard, *J. Am. Chem. Soc.* 63 (1941) 3147.
240. H. T. Schlesinger, H. C. Brown, A. E. Finholt, *J. Am. Chem. Soc.* 75 (1953) 205.
241. R. Flowers, R. J. Gillespie, J. V. Oubridge, *J. Chem. Soc.* 1956, 1925.
242. Olin Mathieson Chemical Corp., US 2867502, 1959 (H. Stange, S. L. Clark).
243. F. C. Kracek, G. W. Morey, H. E. Merwin, *Am. J. Sci.* 35A (1938) 143.
244. G. G. Manov, N. J. DeLollis, S. F. Acree, *J. Res. Nat. Bur. Stand.* 33 (1944) 287.  
*Chem. Abstr.* 39 (1945) 1348.
245. D. White, D. E. Mann, P. N. Walsh, A. Sommer, *J. Chem. Phys.* 32 (1960) 488.  
D. J. Meschi, W. A. Chupka, J. Berkowitz, *J. Chem. Phys.* 33 (1960) 530.

- S. P. Randall, J. L. Margrave, *J. Inorg. Nucl. Chem.* 16 (1960) 29.
246. M. V. Stackelberg, J. Dressel, *Z. Electrochem.* 43 (1937) 14.
247. J. S. McGarth, G. G. Stack, P. A. McCusker, *J. Am. Chem. Soc.* 66 (1944) 1263.
248. D. I. Prichard, E. V. Reid in [12], Section A10, p. 502.
249. C. G. Salentine, *Inorg. Chem.* 22 (1983) 3920.
250. United States Borax Research Corp., unpublished work.
251. N. Morimoto, *Mineral J. (Sapporo)* 2 (1956) 1. *Chem. Abstr.* 52 (1958) 12687.
252. H. Menzel, H. Schulz, L. Sieg, M. Voigt, *Z. Anorg. Chem.* 224 (1935) 1.
253. Stokely-Van Camp, Inc., US 4412978, 1983 (R. T. Ertle).
254. D. D. Wagman, W. H. Evans, E. J. Prosen, *Nat. Bur. Stand. Circ. (U.S.)* 500 (1952) 481.
255. S. Scholle, M. Szmigielska, *Chem. Prum.* 15 (1965) 530. *Chem. Abstr.* 63 (1965) 15629.
256. N. P. Nies, R. W. Hulbert, *Chem. Eng. Data* 12 (1967) 303.
257. "pH Values of Borate Solutions at 20 °C", U.S. Borax Product Catalog.
258. C. Giacorazzo, S. Menchetti, F. Scordari, *Am. Mineral.* 58 (1973) 523.
259. H. Menzel, H. Schulz, *Z. Anorg. Chem.* 245 (1940) 157.
260. G. W. Morey, H. E. Merwin, *J. Am. Chem. Soc.* 58 (1936) 2248.
261. G. Grenier, D. White, *J. Phys. Chem.* 61 (1957) 1681.
262. American Potash & Chemical Corp., US 2177766, 1940 (L. G. Black).
263. S. Block, A. Perloff, *Acta Crystallogr.* 16 (1963) 1233.
264. A. Hansson, *Acta Chem. Scand.* 15 (1961) 934.
265. United States Borax & Chemical Corp., FR 1379 600, 1964 (N. P. Nies, P. F. Jacobs).
266. H. Menzel, H. Schulz, *Z. Anorg. Chem.* 251 (1943) 167.
267. G. T. Furukawa, M. L. Reilly, J. H. Piccirelli, *J. Res. Nat. Bur. Stand.* 68A (1964) 381. *Chem. Abstr.* 61 (1964) 7771.
268. A. Benhassaine, *C.R. Acad. Sci. Ser. C* 274 (1972) 1188. *Chem. Abstr.* 76 (1972) 158924.
269. United States Borax & Chemical Corp., US 3010786, 1961 (D. S. Taylor, N. P. Nies).
270. G. Cialdi, E. Corazza, C. Sabelli, *Alli. Accad. Naz. Lincei* 42 (1967) 236. *Chem. Abstr.* 67 (1967) 77039.
271. C. L. Christ, J. R. Clark, H. T. Evans, *Acta Crystallogr.* 11 (1958) 761.
272. J. R. Clark, C. L. Christ, *Am. Mineral.* 44 (1959) 712.  
J. R. Clark, D. E. Appleman, *Am. Mineral.* 50 (1965) 283.
273. H. Gode, A. Veveris, *Latv. PSR Zinat. Akad. Vestis, Kim. Ser.* 1970, 722. *Chem. Abstr.* 74 (1971) 71020.
274. R. M. Adams (ed.): *Boron, Metallo-Boron Compounds and Boranes*, Interscience, New York 1964. *Chem. Abstr.* 61 (1964) 15652.
275. W. T. Reburn, W. A. Gale, *J. Phys. Chem.* 59 (1955) 19.
276. M. Marezio, H. A. Plettinger, W. H. Zachariasen, *Acta Crystallogr.* 16 (1963) 975.
277. H. A. Lehmann, W. Schmidt, *Z. Chem.* 5 (1965) 111.
278. H. A. Lehmann, W. Schmidt, *Z. Chem.* 5 (1965) 65.
279. G. B. Bokii, V. B. Kravchenko, *Zh. Strukt. Khim.* 7 (1966) 920. *Chem. Abstr.* 66 (1967) 49813.
280. United States Borax & Chemical Corp., US Reissue 27424, 1972 (N. P. Nies, R. W. Hulbert).  
United States Borax & Chemical Corp., US 3649172, 1972 (N. P. Nies, R. W. Hulbert).
281. J. Ozols, I. Teter, A. Ievins, *Latv. PSR Zinat. Akad. Vestis Kim. Ser.* 1 (1973) 3. *Chem. Abstr.* 78 (1973) 165-580.
282. B. E. Warren, *J. Appl. Phys.* 13 (1943) 602. *Tech. Rev.* 43 (1943) 253, 273. *Chem. Abstr.* 37 (1943) 239.
283. G.-J. Su, P.-C. Li, A. C. Ghose, Wright Air Development Division (WADD) Technical Report 59-21, Rochester University, April, 1960.
284. F. C. Eversteyn, J. M. Stevels, H. I. Waterman, *Phys. Chem. Glasses* 1 (1960) 134. *Chem. Abstr.* 55 (1961) 4905.
285. E. W. Fajans, *Mining Annual Review 1984 (June)* 102, published by *Min. J. (London)*.
286. N. N. Greenwood: "Boron", in: *Comprehensive Inorganic Chemistry*, vol. 1, Pergamon Press, New York 1973, pp. 665-991.
287. ACGIH (ed.): *TLVs for Chemical Substances*, ACGIH, Cincinnati, OH, 1982.
288. DFG (ed.): *Maximale Arbeitsplatzkonzentrationen*, Verlag Chemie, Weinheim 1982.
289. R. S. Fischer, H. C. Freimuth, *J. Invest. Dermatol.* 30 (1978) 85.  
M. Pasdeloup, C. Brisson, *Org. Magn. Reson.* 16 (1981) 164.
290. J. A. Rajaratnam, J. B. Lowry, P. N. Avadhani, R. H. V. Corley, *Science* 172 (1971) 11421.
291. Halox-Pigments: *Halox-Pigments*, company information, Pittsburgh 1973.
292. Goslarer Farbenwerke Dr. Hans Heubach, DE 35328061, 1985 (M. Gawol, G. Adrian).
293. PPG Industries, US 4837253, 1989 (J. D. Mansell et al.).
294. Buckman Laboratories Inc., *Barium metaborate*, company information, Memphis, TN 1989.
295. H. Kossmann, *Farbe + Lack* 91 (1985) no. 7, 588-594.
296. H. Wienand, W. Ostertag, *Farbe + Lack* 88 (1982) no. 3, 183-188.
297. S. Hellbordt, *Farbe + Lack* 85 (1979) no. 6 485.

## Part Twelve

## Alkali Metals

|    |    |                 |    |    |    |    |    |    |    |    |    |    |    |    |    |    |    |
|----|----|-----------------|----|----|----|----|----|----|----|----|----|----|----|----|----|----|----|
|    |    |                 |    |    |    |    |    |    |    |    |    |    |    | H  | He |    |    |
| Li | Be |                 |    |    |    |    |    |    |    |    |    | B  | C  | N  | O  | F  | Ne |
| Na | Mg | Al              |    |    |    |    |    |    |    |    |    |    | Si | P  | S  | Cl | Ar |
| K  | Ca | Sc              | Ti | V  | Cr | Mn | Fe | Co | Ni | Cu | Zn | Ga | Ge | As | Se | Br | Kr |
| Rb | Sr | Y               | Zr | Nb | Mo | Tc | Ru | Rh | Pd | Ag | Cd | In | Sn | Sb | Te | I  | Xe |
| Cs | Ba | La <sup>†</sup> | Hf | Ta | W  | Re | Os | Ir | Pt | Au | Hg | Tl | Pb | Bi | Po | At | Rn |
| Fr | Ra | Ac <sup>‡</sup> |    |    |    |    |    |    |    |    |    |    |    |    |    |    |    |
|    |    |                 | †  | Ce | Pr | Nd | Pm | Sm | Eu | Gd | Tb | Dy | Ho | Er | Tm | Yb | Lu |
|    |    |                 | ‡  | Th | Pa | U  | Np | Pu | Am | Cm | Bk | Cf | Es | Fm | Md | No | Lr |

For Francium, see *Radioactive Metals*.

## 50 Lithium

RICHARD BAUER, ULRICH WIETELMANN

|  |      |  |      |
|--|------|--|------|
| 50.1 Introduction .....                                  | 2029 | 50.5.2 Ore Digestion and Production of Lithium Compounds ..... | 2036 |
| 50.2 History .....                                       | 2029 | 50.5.2.1 Acid Digestion .....                                  | 2037 |
| 50.3 Properties .....                                    | 2030 | 50.5.2.2 Alkali Digestion .....                                | 2038 |
| 50.3.1 Physical Properties .....                         | 2030 | 50.5.2.3 Ion-Exchange Processes .....                          | 2039 |
| 50.3.2 Chemical Properties .....                         | 2031 | 50.5.3 Production of Lithium Carbonate from Brines .....       | 2040 |
| 50.4 Occurrence .....                                    | 2032 | 50.6 Lithium Metal and Lithium Alloys .....                    | 2041 |
| 50.4.1 Minerals .....                                    | 2032 | 50.6.1 Production of Metal .....                               | 2041 |
| 50.4.1.1 Lithium Aluminum Silicates .....                | 2032 | 50.6.2 Uses .....  | 2042 |
| 50.4.1.2 Micas .....                                     | 2033 | 50.6.3 Alloys .....  | 2043 |
| 50.4.1.3 Lithium Phosphates .....                        | 2033 | 50.7 Compounds .....   | 2044 |
| 50.4.1.4 Other Minerals .....                            | 2034 | 50.8 Quality Specifications and Analysis .....                 | 2048 |
| 50.4.2 Reserves .....                                    | 2034 | 50.9 Toxicology and Occupational Health .....                  | 2049 |
| 50.4.3 Lithium in Natural Brines .....                   | 2035 | 50.10 Economic Aspects .....                                   | 2049 |
| 50.5 Production of Primary Lithium Compounds .....       | 2036 | 50.11 References .....   | 2049 |
| 50.5.1 Mining of Ore and Production of Concentrate ..... | 2036 |  |      |

### 50.1 Introduction

Lithium (from the Greek word for stone, λίθος,  $A_r$  6.941, is the lightest element that is solid at normal temperature. Its natural isotopes  ${}^6\text{Li}$ ,  $A_r$  6.015, natural abundance 7.42% and  ${}^7\text{Li}$ ,  $A_r$  7.016, natural abundance 92.58%, are not radioactive. The artificial isotopes  ${}^5\text{Li}$ ,  ${}^8\text{Li}$ , and  ${}^9\text{Li}$  have half-lives of  $10^{-21}$ , 0.855, and 0.17 s, respectively. The electronic configuration of the free atom is  $1s^2 2s^1$ . The atomic radius is 0.155 nm (in the metal), and the ionic radius is 0.086 nm [1].

Lithium is a member of group 1 of the periodic table and thus has a valence of 1+. In many respects (e.g., the strong alkalinity of lithium hydroxide solutions and the reactivity of the metal) it has the character of an alkali metal, but it also exemplifies the diagonal relationship in the periodic table in its resemblance to magnesium: the metal forms only the oxide on combustion (not the peroxide), and with nitrogen it forms the nitride directly. Lithium carbonate, fluoride, and phosphate are very slightly water soluble. In contrast to

sodium chloride, lithium chloride is soluble in polar organic solvents such as methanol.

### 50.2 History

The lithium minerals petalite and spodumene were discovered between 1790 and 1800 by JOSÉ DE ANDRADA in an iron ore deposit on the Swedish island of Utö. In 1817 AUGUST ARFVEDSON discovered the element lithium in this petalite deposit after finding discrepancies in his analytical values. BERZELIUS named the element lithion to indicate its occurrence in a stone. In 1818 DAVY and BRANDÉ first prepared lithium metal in extremely small amounts by electrolysis of lithium oxide with a voltaic pile. At about the same time, GMELIN discovered the red flame coloration produced by lithium salts. In 1825 BERZELIUS determined the lithium content of various mineral sources. The first preparation of the metal in gram quantities was achieved in 1854 by BUNSEN and MATTHIESSEN by electrolysis of molten lithium chloride.

For a long time, lithium and its compounds were of only minor interest (e.g., in pharmaceutical applications and as additives to glazes). Only after World War I did an appreciable demand for lithium develop, owing to its use in lithium-containing (0.04%) lead-based alloys (Bahmetall) for bearings. This was the reason for the first industrial production of lithium carbonate and lithium metal in 1923 based on the mineral zinnwaldite by the Hans-Heinrich works of the Metallgesellschaft in Langelshelm, Germany. The availability of lithium carbonate in tonnage quantities made its industrial use possible, at first mainly in the ceramic industry. In 1929, the Maywood Chemical Works in the United States began production of lithium metal and lithium compounds based on German know-how. Lithium production in the United States increased substantially during World War II due to the use of lithium hydride as a convenient source of hydrogen, especially for small balloons carrying transmitter aeriels for emergency use by ships and aircraft in distress and by lifeboats. This has been followed in the last 50 years by increasing use of lithium-based soaps in multipurpose lubricating greases for automotive and industrial use. A further upsurge in demand came from the nuclear industry: the isotope  ${}^6\text{Li}$  yields tritium when subjected to a neutron flux.

The world market for lithium and lithium compounds is now supplied mainly from production facilities in the United States, from the Salar de Atacama in Chile (Cyprus Foote Mineral, formerly Foote Mineral, Lithium Corporation of America), and from production by Chemetall GmbH (a subsidiary of Metallgesellschaft), Frankfurt/Main in Europe. In addition, China and the former Soviet Union export some lithium carbonate and hydroxide and, to a lesser extent, lithium chloride and lithium metal. The small production facilities in Japan are for domestic use only. Between 1960 and 1964, lithium carbonate was produced by Québec Lithium in Canada. Other minor producers of lithium carbonate and hydroxide, e.g., Maywood Chemical Works, Montecatini in Italy, Rhône-Poulenc in

France, and Associated Lead Manufacturers in the United Kingdom, have all since ceased production for economic or technical reasons.

## 50.3 Properties

### 50.3.1 Physical Properties

Lithium, a silvery white metal, is the least dense of all known solids at room temperature,  $mp$  180.54 °C, heat of fusion 431.4 J/g,  $bp$  1342 °C. It has a very low Mohs hardness of 0.6 and is therefore very easy to form.

The density at 20 °C is 0.534 g/cm<sup>3</sup>, and the density of the liquid between 200 and 1600 °C is given very accurately by the equation [2]

$$\rho = 0.515 - 1.01 \times 10^{-4} (t - 200)$$

The vapor pressure at the melting point is calculated to be  $1.88 \times 10^{-8}$  Pa. Between 800 and 1400 °C, it is given by the relationship [2]

$$\log p = 10.4038 - 8283.1/T - 0.7081 \log T$$

The heat of vaporization is 22 705 J/g. The dynamic viscosity at 180.5 °C is  $0.599 \times 10^{-3}$  Pa·s; between this temperature and 1000 °C, it follows the equation [2]

$$\log \eta = -1.5064 - 0.7368 \log T + 109.95/T$$

The surface tension  $\sigma$  at the melting point is 398 mN/m and, between 500 and 1600 °C, is given by [2]

$$\sigma = 0.16(3550 - T) - 95$$

The mean linear coefficient of thermal expansion  $\alpha_m$  between 273 and 368 K is  $56 \times 10^{-6}$  K<sup>-1</sup>, and the mean coefficient of cubical expansion  $\beta_m$  between 291 and 453 K is  $180 \times 10^{-6}$  K<sup>-1</sup>. Lithium melts with a volume change of +1.5%. The volume of the molten metal between 185 and 235 °C is given by [3]

$$V_T = V_{298} [1 + 174.106 \times 10^{-6} (T - 453)]$$

The specific heat  $c_p$  of lithium metal between 20 and 180 °C is 3.3–4.2 J/g. For the molten metal at 450 °C, a value of 4.2 Jg<sup>-1</sup>K<sup>-1</sup> is quoted. Between the melting point and 421.8 °C, the following equation is valid:

$$c_p = 1.083 - 2.00 \times 10^{-4} t$$

and from 421.8 to 895.3 °C:

$$c_p = 1.006 - 1.73 \times 10^{-5} t$$

The critical data are as follows:  $T_c = 3223 \pm 600$  K;  $p_c = 68.9$  MPa;  $V_c = 66 \pm 19$  mL/mol; and  $\rho_c = 0.120 \pm 0.033$  g/cm<sup>3</sup>.

The thermal conductivity, in Js<sup>-1</sup>m<sup>-1</sup>K<sup>-1</sup>, between 250 and 950 °C is given by

$$\lambda = 42.3 + 12.3 \times 10^{-3} t$$

The enthalpy, in J/g, between 500 and 1300 °C is given by [2]

$$\Delta H = -21.248 + 4.1902 \times t - 21.658/t$$

The ionization energy is 5.37 eV, and the electrode potential of the half cell ( $\text{Li} \rightleftharpoons \text{Li}^+ + e^-$ ) is 3.024 V.

Values in the range 0.23–0.31 nm have been quoted for the radius of the hydrated ion [4].

Metallic lithium has good electrical conductivity. The resistivity at 0 °C is 8.55  $\mu\Omega\text{cm}$ , and between 200 and 1000 °C it is given by

$$R = 18.33 + 3.339 \times 10^{-2} t - 6.795 \times 10^{-6} t^2$$

The electrical resistance increases with increasing density under pressure [3].

Between -180 °C and the melting point, lithium crystallizes in a body-centered cubic system ( $a = 0.35$  nm at 20 °C). At ca. -190 °C, an allotropic transformation of  $\alpha$ -lithium into a hexagonal modification with densest close packing occurs.

Very thin lithium films are reddish brown by transmitted light, a color similar to that observed with colloidal dispersions of lithium in inert liquids. Pure lithium vapor emits a red light. The arc spectrum of lithium between 607.82 and 230.22 nm exhibits more than 42 lines, the strongest of which is the red line at 670.8 nm; the orange line at 610.3 nm is also excited in a Bunsen flame. The red spectral line at 670.8 nm can be used to detect lithium chloride in amounts as low as  $1.26 \times 10^{-6}$  mg.

### 50.3.2 Chemical Properties

Lithium metal is very reactive, though considerably less so than other alkali metals. The presence of sodium as an impurity, even in amounts of 0.5–1%, increases its reactivity,

e.g., for the formation of lithium alkyls from lithium metal and organic halides.

A freshly cut surface of lithium metal has a silvery luster. At room temperature in dry air with a relative humidity of less than 1%, the surface remains shiny for several days, although a very thin passive surface layer is formed that is hardly visible to the naked eye and consists mainly of lithium carbonate and oxygen-containing compounds [5]. Lithium metal can therefore be processed in dry air. However, in moist air a dull gray coating, consisting mainly of lithium nitride, lithium oxide, and lithium hydroxide, forms within a few seconds. If lithium ingots are allowed to remain in contact with air for some weeks, the reaction with atmospheric nitrogen extends into the interior of the metal with the formation of reddish brown lithium nitride and can lead to ignition. Even at room temperature dry nitrogen reacts slowly with lithium metal.

Protective gases for lithium metal include the noble gases, dry carbon dioxide, or pure sulfur hexafluoride up to 225 °C. Mineral oil is also suitable as a protective medium.

Lithium burns with a very luminous white flame, forming a dense white smoke consisting mainly of lithium oxide; the flame temperature is almost 1100 °C.

Burning lithium metal reacts with silicates (e.g., sand and concrete) and carbon dioxide. These substances are therefore unsuitable as fire-fighting agents, as is sodium hydrogen carbonate. Powdered limestone (calcium carbonate) and fire-extinguishing powders based on sodium chloride are suitable for fighting lithium fires. Another suitable material is Graphex (from the company CECA), a graphite-sulfate complex whose volume increases many times at high temperature, thereby effectively smothering the burning lithium.

Lithium reacts with water with formation of hydrogen, which ignites under normal conditions only if the metal is finely divided. Molten lithium reacts explosively with water. Lithium reacts with hydrogen to form lithium hydride. This reaction is carried out on an industrial scale at 600–1000 °C. Lithium reacts with gaseous ammonia at elevated tempera-

ture to form lithium amide. The vigorous reaction with halogens produces incandescence. Organic compounds containing active hydrogen or halogen usually react with lithium to form the corresponding organolithium derivative.

Lithium also reacts with boron, silicon, phosphorus, arsenic, antimony, and sulfur upon heating.

A suitable container material for molten lithium metal is low-carbon steel, which has good resistance up to ca. 700 °C. Because lithium reacts with carbides, carbon-steel vessels in contact with liquid lithium are destroyed by decarburization. Up to 1000 °C, niobium, tantalum, or molybdenum can be used; nickel is satisfactory up to 225 °C. Aluminum, calcium, magnesium, silver, platinum, and gold are attacked by molten lithium.

Lithium metal dissolves readily in liquid ammonia, the concentration of the saturated solution at -33.2 °C being 9.8%. A saturated solution of lithium in ammonia has a density of 0.477 g/cm<sup>3</sup> at 19 °C, and is thus the lightest known liquid at this temperature. The concentrated solution has a bronze color, whereas dilute solutions show the blue color typical of alkali metals. Solutions of lithium in ammonia are used to produce lithium acetylide and for Birch reductions in organic chemistry.

## 50.4 Occurrence

Lithium is present in the earth's crust to the extent of ca. 0.006%; it is the 27th most abundant element. Approximately 150 lithium minerals are known. Lithium enrichment in minerals took place in geological time by the fractional crystallization of molten magma. Lithium migrated to the low-viscosity molten phase which eventually solidified as pegmatite. Sometimes lithium ore deposits are also formed in the pneumatolytic phase, as shown by the frequent association of lithium minerals with pneumatolytically formed cassiterite. Typical examples of this are provided by the spodumene deposit at Manono in Zaire and at Kamativi in Zimbabwe. The lithium found in

mineral water sources in magmatic zones was probably formed in a similar manner.

The four most important lithium minerals are amblygonite, spodumene, petalite, and lepidolite. Of these, spodumene and petalite are used directly in the form of ores or concentrates, especially in the glass industry, whereas spodumene concentrate is used in the production of lithium carbonate.

Natural brines with a high lithium chloride content, which are the end result of a natural leaching and evaporation process, are also important in the industrial production of lithium. Given the technology currently available, seawater, which has a lithium content of only ca. 0.17 ppm, cannot be regarded as a viable raw material for economic lithium production.

### 50.4.1 Minerals

Analytical data for the commercially important lithium minerals are given in Table 50.1.

Table 50.1: Typical analyses of lithium minerals, %.

|                                | Amblygonite | Spodumene concentrate | Spodumene glass-grade | Petalite | Lepidolite |
|--------------------------------|-------------|-----------------------|-----------------------|----------|------------|
| Li <sub>2</sub> O              | min. 7      | min. 7                | min. 4.8              | min. 4   | min. 3.5   |
| K <sub>2</sub> O               | ca. 0.2     | ca. 0.7               | 0.12                  | ca. 0.2  | 8–12       |
| Na <sub>2</sub> O              | 0.4–1.1     | 0.5–0.8               | 0.09                  | 0.4–1.4  | 0.3–1.1    |
| Al <sub>2</sub> O <sub>3</sub> | 34–37       | 26–29                 | 17–18                 | 16–18    | 20–28      |
| SiO <sub>2</sub>               | ca. 2.5     | 60–65                 | 74–80                 | 74–78    | 49–55      |
| F                              | ca. 3.5     | ca. 0.2               | max. 0.1              | ca. 0.1  | 4–6        |
| Fe <sub>2</sub> O <sub>3</sub> | ca. 0.2     | 0.5–2                 | 0.1–0.2               | 0.03–0.2 | 0.1–2      |
| P <sub>2</sub> O <sub>5</sub>  | 44.5–50     | ca. 0.5               | max. 0.1              | ca. 0.3  | ca. 0.5    |
| CaO                            | ca. 1       | 0.1qP0.5              | ca. 0.06              | ca. 0.4  | ca. 0.4    |
| MgO                            | ca. 0.1     | 0.1–1                 | ca. 0.05              | 0.2–0.4  | ca. 0.2    |

#### 50.4.1.1 Lithium Aluminum Silicates

**Spodumene** (triphane), LiAlSi<sub>2</sub>O<sub>6</sub>, has a theoretical Li<sub>2</sub>O content of 8.03%, but usually contains 6–7.5% because of partial replacement of Li<sup>+</sup> by Na<sup>+</sup> and K<sup>+</sup>. Spodumene has a monoclinic pyroxene structure consisting of -SiO<sub>3</sub>- chains linked together by aluminum ions, with the balance of the positive charge provided by lithium ions. Spodumene sometimes occurs in the form of large single crystals.

tals. Its color varies from white to gray-green to reddish. Very pure and transparent single crystals are regarded as semiprecious stones (kunzite). The high hardness value of spodumene (6.5–7 on the Mohs scale) leads to considerable abrasive effects when the material is worked. At ca. 1000 °C, naturally occurring α-spodumene undergoes an irreversible phase change to β-spodumene, whereby the volume increases greatly and the density decreases from 3.2 to ca. 2.4 g/cm<sup>3</sup>. Spodumene ores consist of pure spodumene combined with quartz or feldspar; the Li<sub>2</sub>O content ranges from less than 1% to more than 5%.

**Petalite**, LiAlSi<sub>4</sub>O<sub>10</sub>, has a theoretical Li<sub>2</sub>O content of 4.9% but usually contains only 3.5–4.5%. It crystallizes in the form of monoclinic prisms and is white, gray, or reddish in color. It has a density of 2.4 g/cm<sup>3</sup> and a Mohs hardness of 6.5. Petalite decomposes at 1100 °C into β-spodumene and SiO<sub>2</sub>. This transformation (and that of α-spodumene) is important in digestion of the ore.

**Eucryptite**, LiAlSiO<sub>4</sub>, is a relatively rare lithium mineral that occurs mainly in combination with petalite, e.g., in Bikita, Zimbabwe. It has the highest Li<sub>2</sub>O content (11.1%) of the lithium aluminum silicates.

The three minerals are distinguished by their SiO<sub>2</sub> content:

Eucryptite: Li<sub>2</sub>O·Al<sub>2</sub>O<sub>3</sub>·2SiO<sub>2</sub>  
 Spodumene: Li<sub>2</sub>O·Al<sub>2</sub>O<sub>3</sub>·4SiO<sub>2</sub>  
 Petalite: Li<sub>2</sub>O·Al<sub>2</sub>O<sub>3</sub>·8SiO<sub>2</sub>

Thus, thermal transformation of petalite into β-spodumene and quartz can be regarded as a decomposition reaction.

#### 50.4.1.2 Micac

The mica minerals form a subgroup of the aluminosilicates. They are sometimes formed by direct crystallization from molten magma but often owe their origin to pneumatolytic decomposition.

**Lepidolite**, K[Li, Al]<sub>3</sub>[Al, Si]<sub>4</sub>O<sub>10</sub>[F, OH]<sub>2</sub>, lithium mica, is the most important representative of this group. Depending on its origin

and the weathering it has undergone, lepidolite can contain between 3.3 and 7.74% Li<sub>2</sub>O. Economic deposits contain 3–4% Li<sub>2</sub>O. The mineral is often pink to grayish violet and frequently contains 3–5% rubidium and cesium oxides.

**Zinnwaldite**, which has the general formula K[Li, Al, Fe]<sub>3</sub>[Al, Si]<sub>4</sub>O<sub>10</sub>[F, OH]<sub>2</sub>, can be regarded as a variety of lepidolite with a high iron content. The Li<sub>2</sub>O content varies with the actual composition of the mineral. The deposit in Zinnwald (Erzgebirge) contains 2–3% Li<sub>2</sub>O. Zinnwaldite is silvery to grayish brown, sometimes also tinged with red. The emerald green variety known as cryophyllite, found in Massachusetts, contains up to 5% Li<sub>2</sub>O.

#### 50.4.1.3 Lithium Phosphates

Commercial amblygonite is a complex phosphate with the general formula (Li, Na) Al(F, OH)PO<sub>4</sub>. Its principal constituents are pure amblygonite, LiAlFPO<sub>4</sub>, with a theoretical Li<sub>2</sub>O content of 10.1%, and its hydroxyl substitution product, montebrasite, LiAl(OH)PO<sub>4</sub>, with 10.3% Li<sub>2</sub>O. Amblygonite is milky white to gray in color, sometimes also with a brown or green tinge; it may have a sheen resembling a solidified stream of molten glass or a pearly luster. Deposits suitable for mining have an Li<sub>2</sub>O content of 7–9%, the highest of the commercially exploited lithium ores. However, amblygonite is never found in large accumulations but is widely distributed in small, usually lenticular deposits, often associated with other lithium minerals. Although amblygonite once was an important source of lithium, it is no longer regarded as a suitable source of raw material for today's large-scale lithium carbonate production plants.

Triphylite, LiFePO<sub>4</sub>, and lithiophilite, LiMnPO<sub>4</sub>, have a theoretical Li<sub>2</sub>O content of 9.5%. The known deposits yield a raw material with 8–9% Li<sub>2</sub>O; however, they have not been commercially exploited because of their small size.

#### 50.4.1.4 Other Minerals

Lithiophorite,  $[\text{Li, Al}]\text{MnO}_2(\text{OH})_2$ , is often found in veins of manganese ore.

Hectorite, which has the approximate composition  $\text{LiNaMg}_8(\text{Si}_4\text{O}_{10})_3[\text{F, OH}]_6$  and contains ca. 1.2%  $\text{Li}_2\text{O}$ , is the only lithium mineral that occurs in sedimentary rock and clay; it is classified in the montmorillonite group.

The unusual mineral zhabuyelite [6] was discovered recently in salt deposits in the Zha Buye lake in Tibet. It consists of colorless, transparent, monoclinic crystals of almost pure lithium carbonate.

#### 50.4.2 Reserves [7, 8]

The only mineral used as a raw material for the production of lithium compounds at present is spodumene, the largest known deposits of which are at Manono in Zaire. Reserves have been estimated to be over  $2 \times 10^6$  t of lithium [9, 10]. New investigations by Lithium Australia into their own pegmatite deposits in Greenbushes (Western Australia) [11] have revealed reserves with  $7 \times 10^5$  t of lithium, of which ca. 10% is in the form of spodumene with more than 4%  $\text{Li}_2\text{O}$ , ca. 50% with more than 2.5%  $\text{Li}_2\text{O}$ , and ca. 40% with ca. 1.5%  $\text{Li}_2\text{O}$ .

The U.S. producers Cyprus Foote Mineral and Lithium Corporation of America base their operations on deposits in the "tin-spodumene belt" of North Carolina, which may contain as much as  $2.8 \times 10^6$  t of lithium [9, 10].

The Canadian deposits at La Corne, which provided raw material for Québec Lithium, are estimated to contain  $10^5$  t of recoverable lithium, with potential reserves of about twice this amount. Deposits belonging to Tantalum Mining Co. at Bernic Lake amount to ca.  $60 \times 10^3$  t. The total known reserves in Canada are quoted as  $6 \times 10^5$  t of lithium [12].

The deposits at Bikita in Zimbabwe consist mainly of petalite and lepidolite with some spodumene and eukryptite. They contain between  $7.5 \times 10^4$  and  $10^5$  t of lithium. Russia has deposits of spodumene and lepidolite at Krivoj Rog and in Chita in Transbaikal. Other lithium minerals occur in the Altai mountains and on the Kola peninsula. No details are available concerning the extent of these reserves.

In northwest China, considerable reserves of spodumene containing ca. 1.5%  $\text{Li}_2\text{O}$  have been reported in the southern slopes of the Altai mountains in the Koktohay–Aletai region. This provides raw material for lithium carbonate and hydroxide production in Urumchi. No details are available.

In addition to the principal reserves described above, a number of smaller ones exist in the United States, Canada, Australia, Zimbabwe, and China. Lithium minerals have also been found in Afghanistan, Argentina, Brazil, India, Madagascar, Mali, Mozambique, Namibia, and South Africa [13, 14].

The reserves in Europe are all of minor importance and so far have not proved worth mining. This is also true for the spodumene deposit that has recently been investigated in the Koralpe of Austria [15]. This contains  $5 \times 10^6$  t of ore with an average of 1.7%  $\text{Li}_2\text{O}$ . Spodumene has also been found in Lalin and near Caceres in Spain, Dublin in Ireland, and Tammela in Finland. Lepidolite deposits exist in France (Massif Central), Portugal, the island of Elba, Sweden, and central Finland. Petalite also occurs on Elba and at Utö in Sweden.

The confirmed lithium reserves based on pegmatite in the Western world are estimated at  $3 \times 10^6$  t of lithium if recent figures from Greenbushes are included [16]; potential reserves amount to an additional  $4 \times 10^6$  t [9].

Lithium ores are used directly or as flotation concentrate (sometimes mixed with other materials), e.g., in the glass industry or as slag formers in the foundry industry.

Table 50.2: Typical analyses of brines, %.

|                                     | Li <sup>+</sup> | Na <sup>+</sup> | K <sup>+</sup> | Mg <sup>2+</sup> | Ca <sup>2+</sup> | SO <sub>4</sub> <sup>2-</sup> | Cl <sup>-</sup> | Br <sup>-</sup> |
|-------------------------------------|-----------------|-----------------|----------------|------------------|------------------|-------------------------------|-----------------|-----------------|
| Clayton Valley (Nevada)             | 0.02            | 7.5             | 1.0            | 0.03             | 0.05             | 0.75                          | 11.7            |                 |
| Salar de Atacama (Chile)            | 0.15            | 7.6             | 1.8            | 0.96             | 0.03             | 1.78                          | 16.00           | trace           |
| Salar de Uyuni (Bolivia)            | 0.024           | 9.42            | 0.51           | 0.44             | 0.05             | 0.72                          | 15.91           | trace           |
| Salar del Hombre Muerto (Argentina) | 0.06            | 9.8             | 0.6            | 0.09             | 0.05             | 0.82                          | 15.9            | trace           |
| Salar del Rincón (Argentina)        | 0.05            | 10.8            | 0.7            | 0.4              | 0.12             | 0.7                           | 16.7            | trace           |
| Zha Buye Lake (Tibet)               | 0.12            | 14.17           | 3.96           | 0.001            | trace            | 4.35                          | 15.63           | 0.6             |
| Dachaidan, Qinghai (China)          | 0.02            | 10.6            | 0.4            | 1.3              | 0.04             | 2.25                          | 18.7            | 7.0             |
| Dead Sea (Israel/Jordan)            | 0.002           | 3.0             | 0.6            | 4.0              | 0.3              | 0.05                          | 16.0            | 0.4             |
| Great Salt Lake (Utah)              | 0.004           | 7.0             | 0.4            | 0.8              | 0.03             | 1.5                           | 14.0            |                 |
| Boneville (Utah)                    | 0.007           | 9.4             | 0.6            | 0.4              | 0.12             | 0.5                           | 16.0            |                 |
| Seawater                            | 0.000017        | 1.8             | 0.038          | 0.013            | 0.04             | 0.027                         | 1.94            | 0.0004          |

#### 50.4.3 Lithium in Natural Brines

Recently, lithium-containing brines have become important raw materials. Their industrial exploitation began at Searle's Lake, California, in 1938 by Kerr-McGee Chemical, and in Clayton Valley, Nevada in 1966 by Foote Mineral (now Cyprus Foote Mineral).

In 1984, production of lithium carbonate from the brines of the Salar de Atacama in Chile was started by the Sociedad chilena de litio ltda (SCL), now a 100% affiliate of Cyprus Foote Mineral [17]. At the same Salar also, Minsal S.A., a subsidiary of the Chilean mining company Sociedad química y minera de Chile S.A. (SQM Soquimich) started its commercial lithium carbonate production based on brines.

In Argentina, at the Salar de hombre muerto, FMC Corp. is in the process of building a brine-based lithium extraction plant. This project is set for a start-up in 1997.

Because of the extremely high solubility of lithium chloride in water, the basic concentration process for lithium-containing brines is natural evaporation such as occurs only in dry regions of the earth in particular geological formations [18]. The evaporation process leads first to increased lithium content in salt lakes, such as the Dead Sea or the Great Salt Lake. Further enrichment of lithium then takes place if the surface of the lake is completely dried out as in Searle's Lake and Clayton Valley. This enrichment also occurs in the last brines to be formed, which are enclosed in cavities. The surrounding salts can be practi-

cally lithium free or can contain up to 1500 ppm of lithium.

Important reserves of lithium-containing brines are found in western North and South America and in western China (Tibet and Qinghai Province) [6, 19, 20]. Their lithium contents vary greatly (Table 50.2).

The reserves of lithium in these brines are sometimes considerable. It is estimated that the Salar de Atacama in Chile contains more than  $1.1 \times 10^6$  t of lithium, Clayton Valley  $7 \times 10^5$  t of lithium, and the Great Salt Lake  $4.5 \times 10^5$  t of lithium. The quantities of lithium that can be recovered economically from these reserves are, however, much smaller. For the Clayton Valley they are estimated to be  $4 \times 10^4$  t of lithium and for the Great Salt Lake, with coproduction of other salts,  $2.6 \times 10^5$  t [9]. On the other hand, the amount of recoverable lithium from the Salar de Atacama, because of the higher concentration, is considerably larger (up to  $8 \times 10^5$  t). A study by Amax Exploration of the recovery of  $15 \times 10^3$  t/a of lithium carbonate as a coproduct with potassium chloride, potassium sulfate, and boric acid has been completed [21].

Not only is the lithium yield from brines reduced due to dilution caused by replacement of the withdrawn brine by fresh water, lithium is also lost through inclusion in salt crystals that form upon evaporation and in the sludge produced when magnesium is precipitated with lime.

The verified reserves of lithium from salt lakes are estimated to be  $1.8 \times 10^6$  t, and the potential reserves  $18 \times 10^6$  t.

The recovery of lithium from material of low lithium content is also interesting, because of the importance of lithium to nuclear technology. An example is the proposed extraction from the Dead Sea by precipitation as lithium aluminate,  $\text{LiH}(\text{AlO}_2)_2 \cdot 5\text{H}_2\text{O}$  [22]. Also under investigation is the recovery of lithium from seawater [23] which, although it contains only 0.17 ppm of lithium (Table 50.4), represents a total lithium reserve of  $2.5 \times 10^{11}$  t.

Another potential source of lithium is provided by subsurface brines associated with mineral oil. The brine lies beneath the oil layer and is often recovered at the same time as the oil. In Texas, the brines contain up to 692 mg of lithium per liter, but only rarely does the lithium content exceed 100 mg/L [24]. However, the high magnesium content presents a serious technical problem. For example, in the Smack-over brines in Arkansas the magnesium concentration is 20 times that of lithium. Given the other lithium resources available, industrial exploitation of the lithium in these brines does not appear to be considered anywhere at present.

## 50.5 Production of Primary Lithium Compounds

### 50.5.1 Mining of Ore and Production of Concentrate

Lithium ores are recovered by quarrying or open-cut mining according to their location. Because the veins of ore are often only a few meters thick, the mining operation has to follow the veins, or open-pit mining must be used, which involves the removal of relatively large volumes of overburden. The ratio of overburden to ore is usually 3:1–5:1. An important exception is the Greenbushes deposit in Australia, which has veins of ore up to 250 m thick.

If the lithium minerals are largely separated from the accompanying rock, preliminary sorting can be carried out by hand on a conveyor belt. In this way, it is possible to pro-

duce spodumene containing 4–5.5%  $\text{Li}_2\text{O}$  from raw material containing 1–1.5%  $\text{Li}_2\text{O}$ . A mechanical separation process, based on the difference in reflective properties between ore and gangue material, can also be used. This can give good results if the material is first suitably reduced in size.

The concentration of lithium ores by heavy-medium separation always entails large losses of lithium and has therefore not been used commercially.

A flotation process is employed on an industrial scale especially for spodumene [25]. The material is first ground to a grain size of less than 0.3 mm by using rod mills. Material finer than 0.075 mm is then removed (e.g., by hydrocyclone) because it would result in lower recoveries in the flotation process. Flotation agents such as anionic fatty acids in alkaline medium and sulfonated oils in acid medium are recommended. The use of cationic surfactants in hydrofluoric acid solution has also been proposed. The flotation process is carried out in a series of stages. Quartz, feldspar, and mica are concentrated in the foam and spodumene is floated off. The spodumene concentrate contains 5.5–7.5%  $\text{Li}_2\text{O}$ . It can be sieved into fractions with different lithium contents; the coarser fractions have the higher lithium contents. The yield of lithium from the raw mineral after concentration by flotation is 60–80% depending on the milling conditions used.

### 50.5.2 Ore Digestion and Production of Lithium Compounds

The digestion of lithium ore can be carried out with acid or alkali, or by an ion-exchange process using salts. Various processes are reviewed in [26]. Depending on the process and the digestion agent, the product obtained is lithium carbonate, lithium hydroxide, or lithium chloride.

Although amblygonite, triphylite, and lepidolite can be treated directly with the appropriate digestion agent, spodumene and petalite require pretreatment (decrepitation) to convert  $\alpha$ -spodumene to  $\beta$ -spodumene, and petalite to

$\beta$ -spodumene and quartz. Decrementation is carried out in rotary kilns at 1000–1100 °C. It results in a 30% increase in the mineral's volume and a considerable improvement in its grindability.

#### 50.5.2.1 Acid Digestion

The sulfuric acid digestion process can be used for all lithium ores. It is usually carried out at 250–400 °C, although 850–900 °C is recommended for amblygonite because this leads to the formation of insoluble aluminum phosphate which facilitates removal of the insoluble residue.

Sulfuric acid digestion gives a product that contains an insoluble residue, together with lithium sulfate which is leached from the crushed product with hot water. To remove alkaline-earth metals, aluminum, and iron, the solution is neutralized with lime and soda and then filtered. Lithium carbonate is precipitated by adding concentrated sodium carbonate solution. This is carried out near the boiling point, to take advantage of the decreasing solubility of lithium carbonate at higher temperature.

The sulfuric acid process gives good yields of lithium (ca. 90%) and has a relatively favorable energy balance compared with other processes for the production of lithium compounds from ores. Digestion by hydrochloric acid or hydrogen chloride gas at 935 °C has been suggested for the production (by sublimation) of lithium chloride from lepidolite. This process has, however, little significance compared to the sulfuric acid process.

The production of lithium carbonate from spodumene (petalite) by using sulfuric acid is described in detail in [25]. The flow sheet for the process is shown in Figure 50.1. The ore is first crushed to a particle size of 20–80 mm. Alternatively, flotation concentrate, which is already finely divided, is used. The crushed ore is fed into an oil-, coal-, or gas-fired rotary decrepitation kiln, which attains the required temperature (1050–1100 °C) over at least 10 m of its length. The spodumene takes ca. 4 h to pass through the rotary kiln, the dwell time in

the decrepitation zone being 15–30 min, which results in practically complete transformation into  $\beta$ -spodumene.

The heat efficiency is improved by using a countercurrent flow of material and hot gas. The exhaust gases are used to preheat the ore, to heat the roasting furnace, and to concentrate the liquors by evaporation. The spodumene is quite hot as it leaves the rotary kiln, and sometimes a rotary cooler, which can also be used to preheat the combustion air, is necessary.

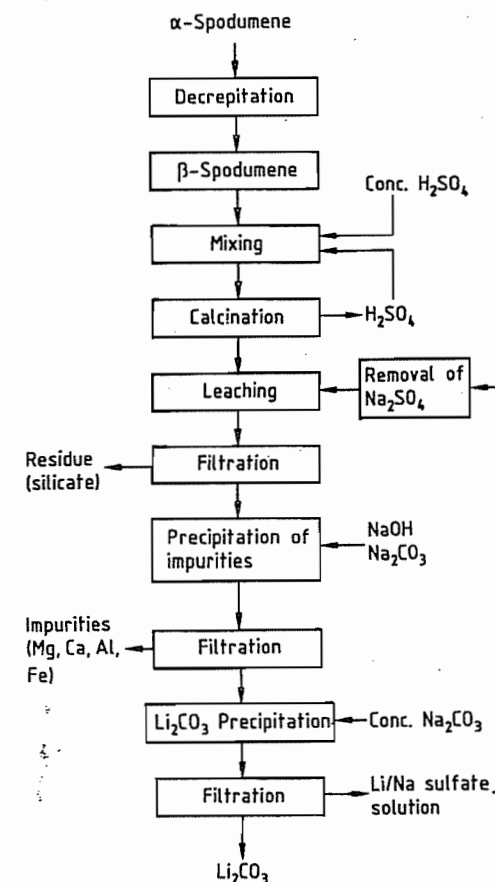

Figure 50.1: Flow sheet for lithium carbonate production from spodumene.

If the starting material is in lump form, the  $\beta$ -spodumene produced by decrepitation is crushed to a grain size of less than 0.1 mm. Sulfuric acid (93%, in 35% excess) is then added either by a mixer conveyor or by spray-



ing onto a band conveyor fitted with a deflector plate. The digestion process, in which lithium in the ore is converted into soluble lithium sulfate, is carried out at ca. 250 °C in a lined rotary furnace or on a conveyor heated by exhaust gases, which carries the spodumene through a tunnel directly to the leaching stage. Digestion is usually complete in less than 1 h.

The lithium sulfate formed is leached out of the reaction product with hot water in Pachuca tanks agitated by compressed air or in stirred vessels. A continuous leaching process, in which the material and the water move countercurrently through several stirred vessels in series, has proved advantageous. After leaching, aluminum silicate residues are removed by a rotary vacuum filter, and the filtrate is treated with lime and soda to precipitate alkaline-earth metals and iron. After repeated filtration, the solution is neutralized with sulfuric acid. During neutralization and in the subsequent evaporation, which concentrates the solution to 200–250 g/L of lithium sulfate, aluminum hydroxide precipitates and is removed together with any purifying additives (e.g., activated charcoal).

The precipitation of lithium carbonate by concentrated sodium carbonate solution is carried out near the boiling point. Lithium carbonate is removed by filtration or centrifugation and washed with hot water to remove the adhering mother liquor (mainly sodium sulfate). It is then dried with a vacuum plate dryer, a band dryer, or a vacuum screw conveyor dryer.

The particle size of lithium carbonate depends strongly on the concentration during precipitation, the temperature, and the rate of addition of sodium carbonate.

Mother liquor from lithium carbonate precipitation always contains ca. 1 g of lithium per liter and is therefore recycled. Before the liquor is returned to the leaching stage, sodium sulfate is removed by crystallization at low temperature. This is a valuable by-product and improves the economic viability of the process.

The use of fluidized-bed furnaces has recently been proposed for the decrepitation process, enabling it to be carried out under mild conditions (Figure 50.2). Recycling of excess sulfuric acid from the dissolution process has also been proposed [27].

### 50.5.2.2 Alkali Digestion

Spodumene and lepidolite can also be digested by reaction with quicklime. Decrepitation of spodumene, calcination of limestone, and digestion are carried out in a single operation. Three parts of limestone are wet milled with one part of lepidolite, or 3.5–4 parts of limestone with one part of spodumene. The mixture is dried in a rotary furnace and then heated to the clinker point to give calcium orthosilicate and lithium aluminate together with excess lime.

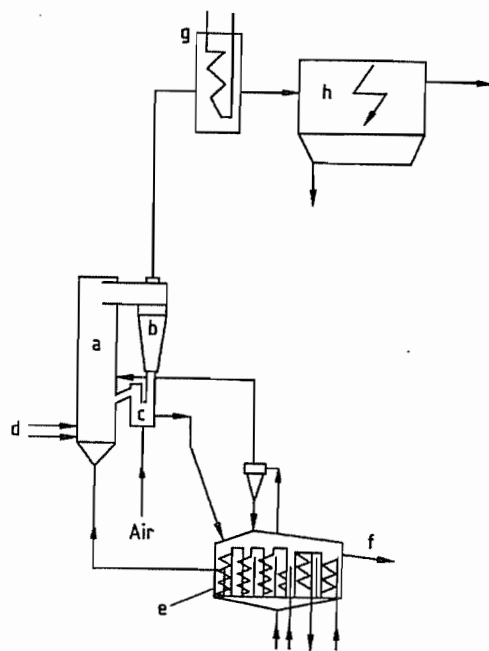

Figure 50.2: Schematic of a fluidized-bed reactor for spodumene decrepitation: a) Fluidized-bed reactor; b) Cyclone; c) Oversize return; d) Raw material feed and fuel supply; e) Countercurrent cyclone cooler; f) Product offtake; g) Heat exchanger (waste-heat boiler); h) Electrostatic precipitator.

The process is critically dependent on the temperature; lepidolite requires ca. 900 °C, and spodumene ca. 1040 °C. If the temperature is too high, a glassy clinker is formed, which severely hinders subsequent leaching of lithium hydroxide; too low a temperature leads to incomplete reaction. Control of the kiln is complicated because of caking and building up of the reaction mixture. In the case of lepidolite, the clinker obtained must be quenched immediately so that no reverse reaction occurs. Spodumene clinker may be cooled slowly, but quenching produces a clinker with better grindability.

After the clinker has been ground in ball mills, lithium hydroxide is leached out with water in several stages. The residues are then separated, and the solution is concentrated in multistage vacuum evaporators to crystallize lithium hydroxide monohydrate. The process has a relatively high energy requirement and gives a lithium yield appreciably below that of the sulfuric acid process. The lower yield is due to the problem of precisely controlling the kiln. For this reason, only the sulfuric acid process is used in the Western world. It is sometimes followed by the conversion of the lithium carbonate into lithium hydroxide. The production of lithium chloride by sublimation from spodumene mixed with calcium chloride and calcium oxide in a one-stage process with decrepitation at 1100 °C also has not become established.

### 50.5.2.3 Ion-Exchange Processes

Ion-exchange processes involve heating a lithium ore with a sodium or potassium salt. This leads to replacement of  $\text{Li}^+$  ions in the ore by  $\text{Na}^+$  or  $\text{K}^+$  and formation of the soluble lithium salt of the anion used.

The digestion of lepidolite by potassium sulfate at 825–875 °C has attracted much interest. Lithium is leached out as lithium sulfate and then separated from excess potassium sulfate. After evaporation, potassium sulfate is crystallized, and lithium carbonate is precipitated by addition of sodium carbonate to the solution. The potassium sulfate is then reused

in the dissolution stage [28]. However, the loss of potassium in the form of potassium aluminum silicate in the insoluble residues is far from negligible, and for this reason the process is no longer used. If lithium production from lepidolite were to be resumed, the sulfuric acid process would probably be favored over ion exchange, because it also produces aluminum sulfate as a by-product and is therefore more economical.

The digestion of  $\beta$ -spodumene with sodium or potassium acetate is carried out at ca. 400 °C [29]. It produces lithium acetate from which lithium carbonate is precipitated by addition of sodium carbonate; the resulting sodium acetate is recycled. In theory, the process consumes an amount of sodium carbonate equivalent to the lithium carbonate produced, the sodium acetate acting only as a carrier and remaining in the system. However, so far, the process has apparently been operated only on a pilot-plant scale.

The Québec process of the Québec Lithium Corporation is a modification of the acetate process in which  $\beta$ -spodumene is treated with aqueous sodium carbonate solution (30% excess) at ca. 200 °C and 5 MPa for at least 10 min. A slurry of sodium aluminum silicate and lithium carbonate is formed, and subsequent treatment with carbon dioxide at low temperature dissolves the lithium, forming the soluble bicarbonate. The insoluble residue is a sodium zeolite that can be marketed. Lithium carbonate is precipitated from the solution by heating to the boiling point. The carbon dioxide generated is used again for the dissolution of lithium carbonate [30].

This process was used on an industrial scale until 1966. It requires considerably more energy than the sulfuric acid process because of the repeated heating of large quantities of water. Furthermore, sodium carbonate is lost through formation of sodium hydrogen carbonate during dissolution of the lithium carbonate with carbon dioxide.

In a further development of the Québec process, pressure digestion of  $\beta$ -spodumene is carried out at 250 °C with aqueous sodium chloride solution made alkaline by the addi-

tion of 0.1–0.2% calcium hydroxide. Lithium carbonate can be precipitated from the resulting liquor by addition of sodium carbonate. Alternatively, lithium chloride can be isolated by solvent extraction (e.g., with *n*-butanol) [31].

### 50.5.3 Production of Lithium Carbonate from Brines

The lithium in brines is at present extracted commercially only at Clayton Valley and the Salar de Atacama. In Clayton Valley, the brines are pumped from wells up to 100 m deep into a series of solar ponds, in which the lithium concentration increases continuously while the accompanying salts precipitate due to oversaturation. The production process requires the lithium concentration to be at least 5000 ppm. If the initial concentration is 200 ppm, the enrichment factor must be at least 30 to obtain solutions suitable for the production process, because lithium losses take place by inclusion in precipitated salts and by seepage of the solution through the solar ponds. This means that at least 95% of the water in the original brine must be evaporated. Such a process can only be operated economically where

solar energy is sufficient to provide high rates of evaporation, i.e., in hot, dry regions of the earth. Brines containing 100 ppm of lithium can be concentrated economically if the magnesium content is low. The concentrated brine is purified and then sodium carbonate solution is added at high temperature to precipitate lithium carbonate, which is separated and dried.

Brines containing less than 100 ppm of lithium (e.g., from Searle's Lake) require a different process to recover the lithium, e.g., by precipitating it first as lithium sodium phosphate,  $\text{Li}_2\text{NaPO}_4$ . This lithium concentrate, known as licon, which contains 20–21%  $\text{Li}_2\text{O}$  is then treated with concentrated sulfuric acid, converting it to phosphoric acid and a solid mixture of lithium and sodium sulfates. This is dissolved, and lithium carbonate is precipitated from the solution by addition of sodium carbonate. The yield of lithium in this process is ca. 88%, which is very good in view of the low starting concentration. The economic viability of the process depends on the recovery of associated by-products such as potassium chloride, sodium sulfate, sodium carbonate, borax, phosphoric acid, and bromine [32]. Lithium production at Searle's Lake was abandoned in the 1970s.

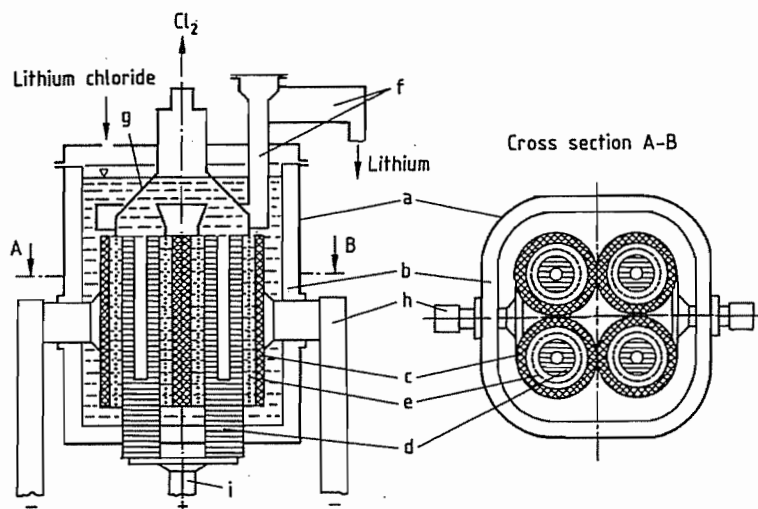

Figure 50.3: Schematic of an electrolytic cell for the production of lithium: a) Steel casing; b) Ceramic lining; c) Cathode with supporting arm; d) Anode; e) Diaphragm; f) Annular collection zone with riser pipe and overflow for lithium; g) Dome for chlorine collection and removal; h) Cathode conductor rail; i) Anode conductor rail.

## 50.6 Lithium Metal and Lithium Alloys

### 50.6.1 Production of Metal

Lithium metal is currently produced only by the electrolysis of molten lithium chloride, whose melting point of 614 °C is lowered by addition of potassium chloride. The lithium chloride potassium chloride eutectic, with 44.3% lithium chloride, melts at 352 °C. The salt mixtures used in industry contain 45–55% lithium chloride, which allows electrolysis to be carried out at 400–460 °C.

The electrolytic cells most commonly employed (Figure 50.3) resemble the Downs cell used for the production of sodium [33].

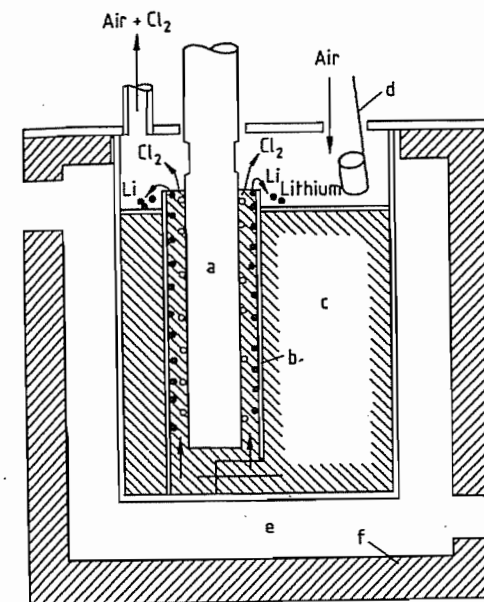

Figure 50.4: Schematic of an American lithium electrolysis cell: a) Graphite anode; b) Steel cathode; c) Melt; d) Ladle; e) Heating chamber; f) Insulation.

The cell and the cathode are constructed from steel, whereas the anode is made of graphite. Four cathode tubes are combined to form a unit, with each tube enclosing an anode cylinder. The anodes enter the electrolysis space from below, and the cathodes are supported by arms attached to the cell sides. The

anode and cathode are separated by a wire-mesh steel diaphragm. The cell is equipped with an insulating inner lining, because both electrodes are introduced below the surface of the melt. Lithium metal is formed at the cathode, rises to the top, and is collected under an argon atmosphere.

In the United States, lithium cells are sometimes operated without a diaphragm or ceramic insulating lining (Figure 50.4) [34]. This greatly prolongs the lifetime of the cells but results in greater power consumption.

Another recently developed lithium electrolysis cell (Figure 50.5) has neither ceramic insulation nor a diaphragm [35]. In this cell, a molten salt mixture containing the lithium metal formed rises continuously in the electrode space and is collected in an annular trough at the top of the cathode near the surface of the melt. It is then transferred through a siphon-like tube to a separation vessel connected to the cell, but isolated from the chlorine gas.

Here, the lithium metal is separated from the electrolyte under an inert-gas atmosphere; the electrolyte is recycled, and the lithium metal is recovered.

The output of an individual cell is usually 200–300 kg of lithium metal per day. The decomposition voltage of lithium chloride is ca. 3.68 V, but in practice 6.0–6.8 V is usually required. The theoretical power consumption is 14.2 kWh/kg of lithium, but the actual figure is 28–32 kWh/kg of lithium. The current efficiency is ca. 90%.

Lithium metal is shipped in steel drums or cans under an argon atmosphere or under a coating of oil. Lithium metal can be stored indefinitely in the absence of air.

Molten lithium can be cast in low-carbon steel molds without special precautions. Its low hardness enables it to be easily extruded or rolled. However, to maintain the silvery luster of lithium, the operation must be carried out in air of very low moisture content or under an inert-gas atmosphere.

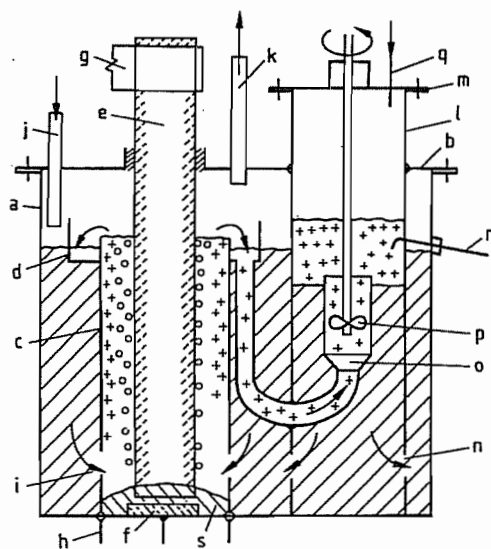

**Figure 50.5:** Schematic of a special electrolytic cell for production of lithium: a) Electrolysis cell; b) Cover plate; c) Cathode; d) Collecting trough; e) Graphite anode; f) Insulating material; g) Anode connection; h) Cathode connection; i) Openings in cathode wall; j) Charging pipe for lithium chloride; k) Chlorine outlet; l) Separating cylinder; m) Cover plate; n) Openings in wall of separating cylinder; o) Pipe connecting trough to separating cylinder; p) Agitator; q) Inlet for inert gas; r) Outlet pipe for lithium; s) Solidified melt.

### 50.6.2 Uses

The largest application of lithium metal is the production of organolithium compounds, principally butyllithium, and lithium hydride.

Lithium is used as a reducing agent in organic chemistry, as a solution in liquid ammonia for Birch reductions, and in the synthesis of vitamins [36].

A rapidly growing application of lithium metal is in sacrificial anodes in batteries. Lithium has a high electrochemical equivalent (3.86 A·h/g) and a low electrochemical potential (−3.045 V). The main advantages of lithium batteries are high power output, extremely good storage properties (low rate of self-discharge), and relatively small power loss at low temperature. Commercially produced primary cells have counterelectrodes made of manganese dioxide, chromium oxide (CrO<sub>2</sub>), or graphite loaded with sulfur dioxide

or thionyl chloride, and electrolytes consisting of lithium salts dissolved in organic solvents such as propylene carbonate or dimethoxyethane. They have cell voltages up to 3 V and energy densities up to 300 Wh/kg [37]. Secondary lithium cells, some based on aluminum lithium alloys, are currently being investigated extensively [38, 39].

Lithium metal is becoming increasingly important as an alloying component; it is also used as a deoxidizing and desulfurizing agent, especially for copper, nickel, and alloy steels.

Lithium and its compounds play a number of important roles in the nuclear industry, e.g., in the production of tritium, as a heat-exchange cooling medium, as a shielding material, and in the form of a molten salt mixture, as a solvent for other nuclear fuels.

These applications depend on the extremely large difference in neutron capture cross section and absorption distance between the two stable lithium isotopes (Table 50.3) [40].

**Table 50.3:** Thermal neutron absorption cross section  $\sigma$  and absorption distance  $\lambda$  for lithium.

| Absorbent                | $\sigma, \times 10^{-24} \text{ cm}^2$ | $\lambda, \text{ mm}^{-1}$ |
|--------------------------|--|----------------------------|
| Natural isotopic mixture | 71                                     | 3                          |
| <sup>6</sup> Li          | 945                                    | 0.2                        |
| <sup>7</sup> Li          | 0.0033                                 | 8000                       |

\*Distance at which radiation energy has decayed to 1/e of the original intensity.

**Table 50.4:** Thermonuclear reaction energies.

| Reaction                                      | Energy, MeV |
|---|-------------|
| <sup>6</sup> Li(n, T) <sup>4</sup> He         | 4.8         |
| <sup>7</sup> Li(n, nT) <sup>4</sup> He        | 2.5         |
| <sup>7</sup> Li(p, $\gamma$ ) <sup>4</sup> He | 19.7        |
| T(D, n) <sup>4</sup> He                       | 17.6        |
| T(T, 2n) <sup>4</sup> He                      | 11.3        |

**Production of Tritium.** The extremely large amount of energy released in thermonuclear reactions (Table 50.4) is illustrated by the hydrogen bomb, in which tritium or its parent substance lithium in the form of <sup>6</sup>Li<sup>2</sup>D reacts with deuterium nuclei. Several fusion reactions have been proposed for power generation. Of these the reaction between deuterium and tritium

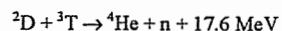

has the best prospect of success because it requires the lowest plasma temperature [41]. The tritium required for the reaction is produced from <sup>6</sup>Li by irradiation with thermal neutrons:

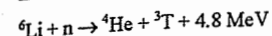

The overall equation for the fusion reaction is [42]:

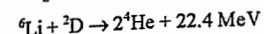

This reaction takes place with loss of neutrons; therefore, neutron multiplication reactions (n, 2n) are used to breed tritium, e.g., based on beryllium or using <sup>7</sup>Li as the starting material according to the equation

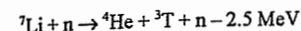

Calculations based on this reaction show that 1 kg of natural lithium could produce  $5 \times 10^{13}$  J of energy.

**Coolants.** In addition to helium at ca. 5 MPa, the following coolants have been proposed for the cooling jacket of a fusion reactor: molten lithium metal, molten LiF–BeF<sub>2</sub>, and molten lead containing 17 atom% lithium. In the latter materials the tritium breeding reaction can take place [41, 43]. An important parameter is the product of density and specific heat which shows that, compared with sodium as a coolant, a lower circulation rate of lithium metal (by a factor of 1.9) can be used. For LiF–BeF<sub>2</sub> this factor is 4.5 [44].

**Solvents for Nuclear Fuels.** Owing to the low neutron capture cross section of <sup>7</sup>Li, a mixture of <sup>7</sup>LiF (72 mol%), beryllium fluoride (16 mol%), thorium fluoride (12 mol%), and uranium tetrafluoride (< 1 mol%) has been proposed as a molten salt fuel for breeder reactors. In these reactors, which are envisaged as small power plants (e.g., in aircraft), the LiF–BeF<sub>2</sub> molten salt mixture acts as a solvent for the nuclear fuel [45].

**Isotope Separation.** The nuclear powers from time to time offer on the world market relatively large quantities of lithium hydroxide in which the natural <sup>6</sup>Li content is reduced by ca. 50%. Separation of the lithium isotopes is carried out either by an isotope-exchange reac-

tion between lithium amalgam and a lithium compound in solution [46] or by continuous ion-exchange chromatography of lithium salt solutions on special ion-exchange resins [47]. The isotopes <sup>6</sup>Li and <sup>7</sup>Li can be purchased with purities of 95–96% and up to 99.9% respectively.

Lithium isotopes are supplied by the Isotopes Sales Department of the Oak Ridge National Laboratory and the US Energy Research and Development Administration.

### 50.6.3 Alloys

Lithium readily forms alloys with other metals such as lead, copper, silver, magnesium, boron, and aluminum [48]. Lithium often completely changes the properties of metals to which it is added, e.g., the hardness of aluminum and lead, or the ductility of magnesium.

The lead alloy Bahmetall, which was developed in Germany in 1918 and contained 0.04% lithium, is no longer important, it was used as a bearing metal for railroad cars until ca. 1955. A eutectic mixture of lead with 17% lithium is used in nuclear fusion technology as a breeder and cooling medium.

The first aluminum–lithium alloy, containing 0.1% lithium, was developed in 1924 in Germany under the name Skleron. In the United States in 1957, the alloy X-2020 (4.5% Cu, 1.3% Li, remainder Al) was used in the wings and horizontal tail surfaces of naval aircraft. During the 1980s, aluminum lithium alloys have been developed continuously, especially by Alcoa, Alcan, and Pechiney. The low density of these materials, compared with the usual aluminum alloys, is of great interest to the aircraft industry. They will probably be used in the foreseeable future for military and large passenger aircraft, despite competition from carbon fiber-reinforced plastics.

Lithium is the only element, apart from beryllium, that simultaneously reduces the density of aluminum and increases its modulus of elasticity; furthermore, formation of the Al<sub>3</sub>Li phase gives improved strength. Modern aluminum lithium alloys are now based almost

without exception on the system Al–Li–Cu–Mg–Zr [49]. The alloy 8090, for example, has the composition 2.3% lithium, 1.3% copper, 0.8% magnesium, 0.12% zirconium, and the remainder aluminum. Such alloys have a density about 10% lower, and a modulus of elasticity ca. 10% higher, than aluminum.

Aluminum–lithium alloys with the composition 50 mol% aluminum and 50 mol% lithium are used in primary thermal batteries in which the electrolyte (a mixture of salts) is melted before the battery is used.

## 50.7 Compounds [50]

**Lithium amide**,  $\text{LiNH}_2$ ,  $\rho$  1.18 g/cm<sup>3</sup>, *mp* 373 °C, is a colorless compound that forms cubic crystals. It is converted to lithium imide,  $\text{Li}_2\text{NH}$ , above 400 °C, with loss of ammonia.

*Production.* Lithium amide is produced industrially by heating lithium metal or lithium hydride in a stream of ammonia. It also forms slowly when lithium metal dissolves in liquid ammonia.

*Uses.* Lithium amide is now used in many reactions in preference to sodium amide for safety reasons, and because it often shows greater selectivity. It is used as a catalyst for Claisen and aldol condensations; as an alkylation catalyst for amines, nitriles, ketones, and monosubstituted alkynes; and as a polymerization catalyst for acrylonitrile and methyl methacrylate.

**Lithium acetate**,  $\text{CH}_3\text{COOLi}$ , is available commercially in the anhydrous form or as the dihydrate. Both are colorless powders that dissolve readily in water to give slightly alkaline solutions.

*Production.* Lithium acetate is produced by reacting lithium carbonate or lithium hydroxide with acetic acid.

*Uses.* Lithium acetate is used to a limited extent in pharmaceuticals. The technical grade is used as a component of catalysts for the production of polyesters [poly(ethylene terephthalate)] or as an additive to improve their physical properties. It is also added to organ-

opolysiloxanes and acrylic polymers to prevent adhesion of ice.

**Lithium benzoate**,  $\text{C}_6\text{H}_5\text{LiO}_2$ , is used in the production of some synthetic polymers (e.g., to harden polyepoxides) [51].

**Lithium citrate**,  $\text{C}_6\text{H}_5\text{Li}_3\text{O}_7$ , is commercially available mainly as a di- or tetrahydrate and is used in the treatment of certain types of manic-depressive illness.

**Lithium bromide**,  $\text{LiBr}$ , *mp* 547 °C,  $\rho$  3.463 g/cm<sup>3</sup>, is a colorless, highly hygroscopic salt. The saturated aqueous solution at 20 °C contains 59.8% lithium bromide and, at 100 °C, 69.9%. The vapor pressure of water above aqueous 52% lithium bromide is 0.53 kPa at 25 °C, 4.98 kPa at 65.6 °C, and 48.1 kPa at 121 °C [52, 53].

*Production.* Lithium bromide is produced by treating an aqueous suspension of lithium carbonate with hydrobromic acid or by reacting lithium hydroxide with bromine. The latter reaction also produces lithium hypobromite, which is reduced to lithium bromide with formic acid or ammonia.

*Uses.* A 50–60% aqueous solution of lithium bromide is used in air conditioners operating by the absorption principle. Solid lithium bromide is a component of oxidation and hydroformylation catalysts. It is also used for deprotonation and dehydration of organic compounds having acidic protons. Mixtures of lithium bromide and lithium carbonate in dimethylformamide are used to carry out mild dehydrohalogenation reactions [36, 54]. Lithium bromide is also used for the purification of steroids and prostaglandins, with which it reversibly forms complexes [55].

**Lithium carbonate**,  $\text{Li}_2\text{CO}_3$ ,  $\rho$  2.11 g/cm<sup>3</sup>, crystallizes as colorless monoclinic prisms that melt with slight decomposition at 732 °C. The technical product is a fine white powder with a bulk density of ca. 0.8 kg/L. Carbon dioxide dissociation pressures over lithium carbonate are as follows:

|                 |     |     |     |     |      |      |
|-----------------|-----|-----|-----|-----|------|------|
| Temperature, °C | 610 | 620 | 740 | 840 | 1000 | 1200 |
| Pressure, kPa   | 0.1 | 0.3 | 1.9 | 3.8 | 9.2  | 30.4 |

Lithium carbonate is only slightly soluble in water; its solubility decreases with increasing temperature.

|                           |      |      |      |      |      |      |
|---------------------------|------|------|------|------|------|------|
| Temperature, °C           | 0    | 20   | 40   | 60   | 80   | 100  |
| Solubility, g/100 g water | 1.54 | 1.33 | 1.17 | 1.01 | 0.85 | 0.72 |

Lithium carbonate dissolves in aqueous carbon dioxide to form lithium hydrogen carbonate. Concentrations of 70 g/L of lithium carbonate at 20 °C and 0.1 MPa carbon dioxide pressure can be reached. Lithium hydrogen carbonate cannot be isolated. Aqueous solutions decompose on heating to form lithium carbonate and carbon dioxide. This reaction is used in the Québec process and for the purification of technical-grade lithium carbonate. Lithium carbonate reacts with acids stronger than carbonic acid to form the corresponding salts. Reaction with calcium hydroxide yields lithium hydroxide.

*Production.* Lithium carbonate is produced entirely from minerals or naturally occurring brines. The solution of lithium salts initially obtained (lithium sulfate, lithium chloride) is reacted with sodium carbonate solution and lithium carbonate is precipitated, or lithium hydrogen carbonate is formed first and then decomposed thermally.

*Uses.* Lithium carbonate is the starting material for the industrial production of all other lithium compounds and is itself used in industry in large quantities. It is an additive in glass, enamels, and ceramics [56, 57] (as are many lithium ores, e.g., spodumene and petalite). The lithium oxide generated by lithium carbonate is a very active flux for silica. It is increasingly replacing fluorspar ( $\text{CaF}_2$ ) for environmental reasons. Its function is generally based on reduction of melting point (particularly important for enamels), reduction of viscosity of molten glass (leading to higher throughput and smaller wall thickness), increased surface tension (giving improved reflexivity to enamels and glazes), and improved chemical resistance. Lithium aluminum silicates with compositions in the range  $\text{LiAlSiO}_4$ – $\text{LiAlSi}_4\text{O}_{10}$  are produced that have extremely low or negative thermal expansion coefficients. These compounds and high-lith-

ium glasses are used in heat-resistant ovenware.

The addition of lithium carbonate to cement or concrete leads to quicker setting. Amounts of 1–5% are used to control setting times [58]. In quick-setting tile adhesives, faster adhesion of the tiles is achieved.

Lithium carbonate is also used as an additive to molten salt baths for the electrolytic production of aluminum. It reacts with aluminum trifluoride in the melt to form lithium fluoride. The concentration used is 2–5%, preferably 3.5%, of lithium fluoride. The following effects are produced: reduction of melting point (by 10–25 °C), density, and viscosity of the melt and an increase in electrical conductivity of ca. 10%. This results in a reduced operating temperature, reduction in fluorine emission (up to 50%), and savings in energy (2–3%) and anode carbon (ca. 2%). It is possible to operate existing electrolytic cells at higher loading (ca. 10%), thus increasing capacity without additional capital investment [59–62].

Specially prepared high-purity lithium carbonate (conforming to the national pharmacopoeias, e.g., U.S.P., DAB, E.P., B.P., J.P.) is used increasingly for the treatment of manic-depressive conditions [63–65]; daily doses of ca. 150–500 mg of lithium carbonate are used. The successful treatment of herpes, alcoholism, and cancer by lithium carbonate assisted chemotherapy has also been reported [65]. Mixtures of lithium and potassium carbonate are used as electrolytes in molten carbonate fuel cells (MCFCs). The MCFC, operating at high temperatures (600–650 °C), is especially suited for 21st-century coal-fired baseload electric utility plants or in natural gas units. The high-quality waste heat can be used for industrial cogeneration or internal reforming [82].

**Lithium chloride**,  $\text{LiCl}$ , *mp* 614 °C, *bp* 1382 °C,  $\rho$  2.07 g/cm<sup>3</sup>, crystallizes in a cubic system. Its solubility in water is as follows:

|                           |      |      |      |       |       |
|---------------------------|------|------|------|-------|-------|
| Temperature, °C           | 20   | 40   | 60   | 80    | 100   |
| Solubility, g/100 g water | 83.2 | 89.8 | 98.4 | 111.9 | 128.3 |

Its solubility in ethanol at 25 °C is 2.5 g/100 g, and in methanol, 17 g/100 g.

**Production.** The known methods of producing lithium chloride from lithium ores have not been adopted commercially. At present, it is produced exclusively by reaction of lithium carbonate and hydrochloric acid, with special steel or nickel equipment because of the extreme corrosivity of lithium chloride. Concentration of the solution (e.g., in a vacuum evaporator) causes lithium chloride to crystallize. It is then separated from the mother liquor, dried, and packed in moisture-proof containers.

**Uses.** Lithium chloride is extremely hygroscopic; thus, like lithium bromide, it is used for drying gases and in air conditioners of the absorber type. Because molten lithium chloride readily dissolves metallic oxides, it is used as a component of fluxes and dipping baths for welding and brazing aluminum and light metal alloys. Most of the lithium chloride produced is used as starting material for the production of lithium metal by molten salt electrolysis.

**Lithium cobalt(III),**  $\text{LiCoO}_2$ ,  $\rho$  5.16 g/cm<sup>3</sup>, can be used as cathodic material in secondary lithium ion batteries [83]. The active dark material with a theoretical specific capacity of 137 Ah/g is prepared by sintering  $\text{Li}_2\text{CO}_3$  with  $\text{CoCO}_3$  at 900 °C. The first cells with a cylindrical design have been commercialized by Sony Corp. [84]

**Lithium hypochlorite,**  $\text{LiOCl}$ , is produced by reacting either chlorine with lithium hydroxide solution, or calcium hypochlorite (bleaching powder) with lithium sulfate. Unlike sodium hypochlorite, it may be obtained in solid form (e.g., by spray drying), although overheating must be avoided because oxygen is liberated above 100 °C.

Lithium hypochlorite is increasingly used as a disinfectant and bleaching agent for swimming pools and in food preparation areas (e.g., dairies and butcher shops). Its action in swimming pools is analogous to that of the cheaper calcium hypochlorite, but it does not increase the hardness of water and is completely soluble.

**Lithium perchlorate,**  $\text{LiClO}_4$ ,  $\rho$  2.428 g/cm<sup>3</sup>, crystallizes from aqueous solution as the trihydrate (*mp* 95.1 °C), which is converted into the anhydrous compound at 130–150 °C via the dihydrate stage. Anhydrous lithium perchlorate melts at 236 °C and is stable up to 400 °C. Like lithium chloride, it is readily soluble in water (56.3 g/100 g water at 20 °C; 196.9 g/100 g water at 95.1 °C).

Lithium perchlorate is produced by reaction of lithium hydroxide or lithium carbonate with perchloric acid. It is used as a conducting salt in electrolytes for lithium batteries.

Further on, solutions of  $\text{LiClO}_4$  in polar aprotic solvents (e.g., diethyl ether) produce a dramatic acceleration of Diels–Alder reactions due to the Lewis acid character of the lithium ion [85].

**Lithium tetrafluoroborate,**  $\text{LiBF}_4$ ,  $\rho$  2.04 g/cm<sup>3</sup>, and lithium hexafluoroarsenate,  $\text{LiAsF}_6$ , are of potential interest as conducting salts for the electrolytes in lithium batteries.

**Lithium hexafluorophosphate,**  $\text{LiPF}_6$ , dec. 130 °C, is highly soluble in aprotic solvents like ethers, carbonates, etc., and decomposes slowly in water under formation of HF. Due to its high solubility and electrochemical stability, it is the most preferred conducting salt for secondary lithium batteries [86].

**Lithium chromate,**  $\text{Li}_2\text{CrO}_4$ , is used as a corrosion inhibitor in air conditioners that contain lithium chloride or bromide solutions. It is made from lithium hydroxide and chromic acid.

**Lithium fluoride,**  $\text{LiF}$ ,  $\rho$  2.6 g/cm<sup>3</sup>, *mp* 870 °C, is used as a flux for enamel and glass, and for brazing and welding light metals.

**Lithium hydride,**  $\text{LiH}$ ,  $\rho$  0.82 g/cm<sup>3</sup>, is used increasingly as a selective reducing agent for polar groups (e.g., esters, amides, nitriles) in organic compounds, although the complex hydrides are of much greater importance: e.g., lithium tetrahydridoaluminate, lithium aluminum hydride,  $\text{LiAlH}_4$ , and lithium tetrahydridoborate, lithium borohydride,  $\text{LiBH}_4$ . It can be used for the hydrogenolysis of Si–Cl bonds, e.g., in the production of monosilane ( $\text{SiH}_4$ )

by the Sundermeyer process [66] or SiH-containing polymers [87].

**Lithium hydroxide monohydrate,**  $\text{LiOH} \cdot \text{H}_2\text{O}$ ,  $\rho$  1.83 g/cm<sup>3</sup>, loses water on heating to form anhydrous lithium hydroxide,  $\text{LiOH}$ ,  $\rho$  1.46 g/cm<sup>3</sup>, *mp* 462 °C.

**Production.** The production of lithium hydroxide monohydrate by digestion of spodumene with lime has been replaced for economic reasons by the reaction between lithium carbonate and calcium hydroxide:

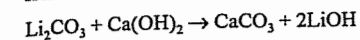

This yields solutions containing up to 3.5% lithium hydroxide. Attempts to work at higher concentration lead to loss of lithium carbonate in the calcium carbonate residue, because the solubility of lithium carbonate is reduced by the presence of lithium hydroxide. The reaction between these sparingly soluble starting materials requires intensive agitation and gives yields just over 95% after many hours. The insoluble residue (mainly calcium carbonate) is removed, and lithium hydroxide monohydrate is crystallized from the mother liquor by evaporation, under vacuum if required. It is then separated and dried at 130–140 °C. Further heating to 150–180 °C produces calcined lithium hydroxide ( $\text{LiOH}$ ). The removal of water can be accelerated by use of vacuum.

Other production processes that have been proposed include the reaction of lithium sulfate solution with barium hydroxide and the reaction of lithium carbonate with silicic acid in the molten state followed by hydrolysis of the lithium silicate formed. These processes are, however, of little more than academic interest.

The solubility of lithium hydroxide monohydrate in water is as follows:

| Temperature °C            | 20   | 40   | 60   | 80   | 100  |
|---------------------------|------|------|------|------|------|
| Solubility, g/100 g water | 21.6 | 22.0 | 23.1 | 25.6 | 29.6 |

**Uses.** Lithium hydroxide is used mainly for the production of lubricating greases. Over 50% of the greases used today in motor vehicles, aircraft, and heavy machinery contain lithium stearates, mainly lithium 12-hydroxystearate. These greases have good viscosity

properties up to 200 °C and are practically insoluble in water.

Lithium hydroxide is also used in the production of dyes [67]. It has attained some importance as an additive to nickel–iron accumulators and, in its calcined form (98%  $\text{LiOH}$ ), as an absorbent for carbon dioxide in breathing apparatus, especially for crews of submarines and space vehicles. One gram of anhydrous lithium hydroxide absorbs 450 mL of carbon dioxide, so that ca. 750 g of lithium hydroxide is sufficient to absorb the carbon dioxide generated by one person in one day. Lithium hydroxide is also used in the building industry. As additive to the mix water, it helps to prevent the so-called “alkali–silica reactivity”, that is a source of distress (cracking).

**Lithium iodide,**  $\text{LiI}$ ,  $\rho$  4.0 g/cm<sup>3</sup>, is a yellowish crystalline powder that is prepared by reaction of lithium hydride with iodine in diethyl ether. It is used in organic syntheses to accelerate the aldol condensation of ketones with enolizable or nonenolizable aldehydes [68] and to cleave methyl esters and oxides [69]. Lithium iodide is also of interest for the manufacture of rapid solid ionic conductors [70]. **Lithium iodide trihydrate,**  $\text{LiI} \cdot 3\text{H}_2\text{O}$ ,  $\rho$  2.5 g/cm<sup>3</sup>, is prepared by reaction of lithium hydroxide with hydriodic acid.

**Lithium manganese oxide,**  $\text{LiMn}_2\text{O}_4$ ,  $\rho$  4.28 g/cm<sup>3</sup>, is a ternary spinel-type double oxide commonly prepared by sintering a manganese oxide ( $\text{MnO}_2$  or  $\text{Mn}_2\text{O}_3$ ) with  $\text{Li}_2\text{CO}_3$  at high temperatures. This salt is a possible low-price candidate for cathodes in high-power secondary lithium ion batteries. Practical specific capacities are between 90–120 mAh/g [83, 89].

**Lithium nitrate,**  $\text{LiNO}_3$ ,  $\rho$  2.37 g/cm<sup>3</sup>, is used, with other salts, to produce eutectic molten salt baths for vulcanization [71]. A salt mixture consisting of lithium and potassium nitrate is available under the trade name “Sabalith<sup>®</sup>” [88]. Unless conventional nitrite (e.g.,  $\text{NaNO}_2$ )-containing salt mixtures, Sabalith<sup>®</sup> is not classified as a toxic substance and helps to reduce emissions of nitrous gases and carcinogenic nitrosoamines.

**Lithium nitride**,  $\text{Li}_3\text{N}$ ,  $\rho$  1.38 g/cm<sup>3</sup>, could attain industrial importance as a solid ionic conductor. It is also used together with magnesium boride and hexagonal boron nitride to prepare cubic boron nitride [72].

**Lithium oxide**,  $\text{Li}_2\text{O}$ ,  $\rho$  2.01 g/cm<sup>3</sup>, is formed when lithium hydroxide is heated to 800 °C in vacuum. It is also obtained by the reaction of lithium metal with oxygen, which proceeds without formation of lithium peroxide.

**Lithium peroxide**,  $\text{Li}_2\text{O}_2$ ,  $\rho$  2.297 g/cm<sup>3</sup>, is formed by reaction of lithium hydroxide solution with hydrogen peroxide; it can be isolated by careful evaporation in vacuum. It has some importance as a hardener for the formation of special polymers and for air purification in sealed spaces (submarines, breathing apparatus, space travel). One gram of  $\text{Li}_2\text{O}_2$  produces 0.348 g of oxygen and absorbs 0.96 g of carbon dioxide.

**Lithium double oxides** are also known as lithium ceramics, and are used to a small extent in the ceramic and enamel industries. They include lithium aluminate,  $\text{LiAlO}_2$ ; lithium borate,  $\text{LiBO}_2$ ; lithium cobaltite,  $\text{LiCoO}_2$ ; lithium manganite,  $\text{Li}_2\text{MnO}_3$ ; lithium molybdate,  $\text{Li}_2\text{MoO}_4$ ; lithium silicate,  $\text{Li}_2\text{SiO}_3$ ; lithium titanate,  $\text{Li}_2\text{TiO}_3$ ; and lithium zirconate,  $\text{Li}_2\text{ZrO}_3$ .

Lithium aluminate is of some importance as a construction material in fusion reactors [73] and fuel cells [74].

**Lithium tetraborate**,  $\text{Li}_2\text{B}_4\text{O}_7$ , either pure or doped with beryllium or strontium as an internal standard, is used as a flux in X-ray spectroscopy and optical emission spectral analysis. It also has limited application in the manufacture of special lithium-containing, high-performance lubricating greases.

**Lithium phosphate**,  $\text{Li}_3\text{PO}_4$ ,  $\rho$  2.537 g/cm<sup>3</sup>, is sparingly soluble in water (ca. 0.04%). It is prepared by precipitation from solutions of lithium salts by addition of phosphates or phosphoric acid. It has some importance as a component of protective optical heat filters, in the corrosion protection of vessels for poly-

mer production, and in the catalytic production of allyl alcohol.

**Lithium sulfate**,  $\text{Li}_2\text{SO}_4$ ,  $\rho$  2.221 g/cm<sup>3</sup>,  $mp$  860 °C, is a colorless salt produced from lithium carbonate and sulfuric acid. It is used in the anhydrous or hydrated form for the treatment of manic-depressive conditions [40]. It has also been considered for the production of quick-setting cements.

**Other Lithium Salts.** Lithium azide, borate, cyanide, molybdate, and salicylate, are prepared by reaction of lithium carbonate or lithium hydroxide with the corresponding acids. Lithium niobate and lithium tantalate single crystals are used as ferroelectric materials and also have acousto-optical properties that can be utilized in optical data transmission systems.

## 50.8 Quality Specifications and Analysis

Lithium metal of standard grade has a purity in excess of 99%, and contains ca. 0.5% sodium. Battery grade lithium contains less than 200 ppm of sodium. Standard quality lithium is usually produced in the form of bricks or cylinders 0.1–1 kg in weight, rods with a diameter of 10–20 mm, or granules with a diameter of ca. 2.5 mm. Battery grade lithium is supplied as foil with a thickness down to 0.05 mm.

Lithium is detected qualitatively by its characteristic red flame coloration; this is also used for quantitative determination by flame emission spectroscopy, in which the emission line at 670.8 nm is measured. Analysis is carried out by using diffraction or refraction spectrometers. In the presence of interfering ions, especially other alkali metals, a calibration curve should be used to obtain adequate accuracy ( $\pm 1\%$ ) [75].

Lithium can also be determined by gravimetric, titrimetric, and colorimetric methods, after precipitation as the periodate, phosphate, zinc uranyl acetate, aluminate, or fluoride [76]. Lithium sulfate can be used as a primary

standard. Lithium hydroxide and organolithium compounds can be determined easily by acidimetric methods. Indirect methods for the determination of lithium salts are also used, e.g., separation of the lithium by ion exchange followed by titration of the acid produced and, for lithium salts of organic acids, by titration with perchloric acid in nonaqueous media [77].

Analysis of lithium hydrides can be carried out by measuring the volume of gas evolved on hydrolysis. For low concentrations of lithium, ion-exchange chromatography is most suitable [78].

## 50.9 Toxicology and Occupational Health

The lithium ion is considerably more toxic than the sodium ion; for example, 5 g of lithium chloride can cause fatal poisoning. On the other hand, lithium salts have received widespread clinical use for over 30 years in the treatment of manic-depressive illness. Thus therapeutic doses of 170–280 mg/d Li in the form of mainly lithium carbonate are administered over long periods.

Lithium is an environmental trace element, the background exposure is estimated to be about 2 mg/d Li and to have beneficial effects [90].

In Europe and in the United States, there are no special regulations concerning lithium in waste waters. Lithium is included as a part of the allowed salt emissions.

No industrial disease caused by ingestion of lithium compounds has been reported thus far. Lithium hydroxide has caustic properties similar to those of other alkali-metal hydroxides; the caustic action of lithium hydride and lithium aluminum hydride is due to the lithium hydroxide formed by hydrolysis. Details of the toxicity and therapeutic possibilities of lithium are given in [63, 65].

## 50.10 Economic Aspects

The information available concerning world production of lithium ores is incomplete [79]. Including those amounts used for lithium carbonate production, it can be estimated at  $6 \times 10^5$  t/a.

In 1992, estimated consumption of lithium minerals in the Western World for direct use (e.g., in the glass, ceramics, and metallurgical industries) was  $8.55 \times 10^4$  t/a (corresponding to about  $1.2 \times 10^4$  t lithium carbonate equivalents). An additional  $1.5$ – $2.0 \times 10^5$  t were used in the production of lithium chemicals.

The bulk prices (FOT Amsterdam) in May 1995, in U.S. dollars per ton, were

|   |     |
|---|-----|
| Petalite (4.2% $\text{Li}_2\text{O}$ )                | 147 |
| Spodumene concentrate (> 7.5% $\text{Li}_2\text{O}$ ) | 385 |
| Glass-grade spodumene (5% $\text{Li}_2\text{O}$ )     | 175 |

The consumption of lithium compounds (calculated as lithium carbonate) in the Western world was ca.  $3.2 \times 10^4$  t in 1989, with an annual rate of increase of ca. 3–4%. Approximately 40% of the lithium production was consumed by the United States, where, together with Chile, the main ore and brine deposits are to be found. The capacity available at present together with the projected expansion will ensure that the market remains satisfied. About 25% of the lithium produced is used in the lubrication industry, 25% in the aluminum industry, 25% in the enamel, glass, and ceramic industries, and the rest for miscellaneous uses such as chemicals, pharmaceuticals, catalysts for the rubber industry, additives for welding materials, and absorbers in air conditioners.

Bulk prices in the United States in November 1996, in U.S. dollars per kg, were:

|                               |       |
|-------------------------------|-------|
| Lithium carbonate             | 4.25  |
| Lithium hydroxide monohydrate | 5.73  |
| Metallic lithium              | 89.51 |
| Lithium chloride              | 8.91  |
| <i>n</i> -Butyllithium        | 47.18 |

## 50.11 References

1. M. F. C. Ladd, *Theor. Chim. Acta* **12** (1968) 333–336.

2. E. J. Cairns, F. A. Cafasso, V. A. Maroni: *Chemistry of Fusion Technology*, Plenum Publishing Corp., New York 1972, pp. 91–160.
3. Landolt-Börnstein, 6th ed., IV, Part 2, pp. 326–330.
4. Gmelin, System no. 20, Lithium, p. 150.
5. H. Roy, E. Geiss, *Microbeam Analysis 1981*, San Francisco Press, San Francisco 1981, pp. 303–308.
6. Xiang Jun: "Study of Zha Buyesaline/Lake Tibet", *Scientific papers on geology for the 27th Internat. Geol. Congr.* 4 (1985) 173–184, Geol. Publ. House, Beijing.
7. I. A. Kunasz, "Lithium Raw Materials", in S. J. Le-fond (ed.): *Industrial Minerals and Rocks*, 5th ed., American Institute of Mining, Metallurgical and Petroleum Engineers, New York 1983, vol. 2, pp. 869–880.
8. D. London, D. M. Burt: "Lithium Minerals in Pegmatites", *Short Course Handb. Mineral. Assoc. Can.* 8 (1982) 99–133.
9. R. K. Evans: "Lithium Reserves and Resources", *Energy* 3 (1978) 379–385.
10. I. A. Kunasz: "Lithium how much?" *Footprints* 44 (1980) no. 1, 23–27.
11. K. R. Suttill, *Eng. Min. J.* 188 (1987) 40–43.
12. Minister Energy, Mines, Resources Canada, "Lithium, an Imported Mineral Commodity", *Mineral Bulletin MR 212*, Canadian Government Publishing Centre, Ottawa 1986, p. 24.
13. G. Aubert: "Le Lithium", *Éditions Bureau recherches géologiques et minières, Paris XV* (1963) no. 2, 23–93.
14. M. L. Deshpande: "Lithium Resources in India", *Indian Miner.* 32 (1978) no. 4, 41–47.
15. "Minerex explores for Lithium", *Ind. Miner.* 1984, no. 8, 9.
16. D. I. Bleiwas, J. S. Coffman: "Lithium Availability Market Economy Countries", Bureau of Mines, U.S. Dept. of Interior, Inf. Circular 9102, Washington, DC, 1986.
17. M. Coad: "Lithium Production in Chile's Salar de Atacama", *Ind. Miner.*, Oct. 1984, 27–33.
18. J. R. Davis, J. D. Vine: "Stratigraphic and Tectonic Setting of the Lithium Brine Field, Clayton Valley, Nev.", *Basin and Range Symp.*, Oct. 7–11, 1979, Rocky Mountain Assoc. Geol. 1979, pp. 421–430.
19. "China Finds Lithium", *Min. Mag.* 155 (1986) no. 4, 303.
20. Qian Ziqiang, Xuan Zhiqiang: "Borate Minerals in Salt Lake Deposits at Chaidamn Basin, China", *Sixth Intern. Sympos. on Salt*, Salt Institute, vol. I, 1983, 185–194.
21. "Chile Aims at Top Producer Slot", *Metal Bull. Monthly*, Jan. 1988, p. 61.
22. D. Kaplan, *Isr. J. Chem.* 1 (1963) 115–120.
23. M. Steinberg, Vi-Duong Dang: "Preliminary Design and Analysis of a Process for the Extraction of Lithium from Seawater", *Lithium Resources and Requirements by the Year 2000, Geological Survey Professional Paper*, no. 1005, US Government Print Office, Washington 1976, pp. 79–88.
24. A. G. Collins: "Lithium Abundances in Oilfield Waters", in [23], pp. 116–123.
25. A. E. Schreck, *U.S. Bur. Mines, Inf. Civ.* 1961, no. 8053, 36–41.
26. G. G. Gabra, A. Torma: "La métallurgie extractive du lithium", *L'Ingénieur* (Montréal, École polytechnique), March, April 1977, 10–15.
27. Metallgesellschaft AG, *Verfahren zur Gewinnung von Lithiumcarbonat*, DE-OS 3622105 A1, 1988 (P. Brödemann, G. Krüger, H. Heng).
28. G. von Girsowald: "Lithium", *Mitt. d. Metallgesellschaft* 2 (1929) 13–20.
29. J. Tixhon, *Ind. Chim. Belge Suppl.* 1 (1959) 752.
30. M. Archambault, US 3112171, 1963.
31. G. G. Gabra, A. E. Torma, C. A. Olivier, *Can. Metall. Q.* 14 (1975) no. 4, 355–358.
32. L. E. Rykken: "Lithium Production from Searles Valley" in [23], pp. 33–34.
33. W. Hinrichs, L. Lange in Winnacker, Küchler (eds.): *Chemische Technologie*, 4, Carl Hanser Verlag, München-Wien 1986, p. 334.
34. R. Bauer, *Chem. Ing. Tech.* 44 (1972) 147–151.  
H. Lauck: "Galvanische Zellen mit organischen Elektrolyten", *BMFT-Forschungsbericht T 74-02*, 1974.  
F. J. Krüger, H. Lauck, E. Voss, *Chem. Ing. Tech.* 50 (1978) 284.  
J. O. Besenhard, G. Eichinger, *J. Electroanal. Chem.* 68 (1976) 1–18.
35. Metallgesellschaft AG, EP 0217438 A1 (J. Müller, R. Bauer, B. Sermond, E. Dolling).
36. L. F. Fieser, M. Fieser: *Reagents for Organic Synthesis*, J. Wiley & Sons, New York 1967, pp. 54–56.
37. J. P. Gaban: *Lithium Batteries*, Academic Press, New York 1983.
38. K. M. Abraham in R. O. Bach (ed.): *Lithium—Current Applications in Science, Medicine and Technology*, J. Wiley & Sons, New York 1985, pp. 155–175.
39. D. Vissers, Z. Tomczuk, L. Redey, J. Battles in R. O. Bach (ed.): *Lithium—Current Applications in Science, Medicine and Technology*, John Wiley & Sons, New York 1985, pp. 121–153.
40. A. Klemm, *Angew. Chem.* 70 (1958) 21–24.
41. R. Klingelhöfer, *Chem. Ztg.* 111 (1987) 85.
42. C. M. Braams, *9th World Energy Conference*, Paper 4.1–11, London 1974, pp. 181–190.
43. H. U. Borgstedt, V. Coen, S. Malang: "Füussige Brutstoffe", *Jahrestagung Kerntechnik 1987*, Deutsches Atomforum e.V., Bonn 1987.
44. W. Dänner, *Reaktortagung*, Hamburg 1972, Deutsches Atomforum e.V., Bonn 1972, pp. 747–750.
45. C. F. Baes, Jr., *J. Nucl. Mater.* 51 (1974) no. 1, 149–162.
46. Commissariat à l'énergie atomique, DAS 1244750, 1960 (E. Saito, G. sur Yvette, G. Dirian, S.-O. Pal-laiseau).
47. CEER, *Chem. Econ. Eng. Rev.* 15 (1983) 32.
48. P. D. Frost, *Batelle Tech. Rev.* 8 (1959) 3–8.
49. M. Peters, K. Welpman, *Metall* 39 (1985) 1141–1144.
50. W. A. Hart, O. F. Beumel, Jr.: *Comprehensive Inorganic Chemistry*, vol. 12, Pergamon Press, Oxford–New York 1972, pp. 331–367.
51. Shell B.V., DE 1914004, 1969 (G. Rossa).
52. W. Pennington, *Refriger. Eng.* 63 (1955) 57–61.
53. D. S. Davis, *Chem. Eng.* 64 (1957) 292–294.
54. Sterling Drug Inc., US 885776, 1978 (M. R. Bell, J. L. Herrmann, V. Akullian).

55. Searle, DE 3207470, 1981 (J. B. Hill, R. A. Erickson).
56. J. H. Fishwick: *Application of Lithium in Ceramics*, Cahners Publ. Comp., Boston, MA, 1974.
57. B. R. Franklin, L. C. Klein: "Lithia in Container Glass", *Am. Ceram. Soc. Bull.* 62 (1983) 209.  
H. R. Carroll, J. I. Angelo: "Adding Lithium Can Improve Melting-Forming Performance", *Glass Ind.*, Nov. 1983, 14–18.
58. Woellner Werke, DE-OS 2725524, 1978 (W. R. Semle).  
Armstrong World Industries, DE-OS 3541614, 1986 (J. O. Presley).  
Tokuyama Soda Co., IP 77121632, 1977 (T. Fukunaga, H. Iwakura, T. Uchiyama, H. Kono).
59. K. Grjotheim et al.: *Aluminium Electrolysis, the Chemistry of the Hall-Héroult Process*, Aluminium-Verlag, Düsseldorf 1977.
60. R. Pawlek: Übersicht über das Verhalten lithiumhaltiger Salze in der Tonerdeschmelzflußelektrolyse, Schweizerische Aluminium AG, Zürich 1981.
61. H. Kvande: "The Optimum Bath Composition in Aluminium Electrolysis, does it exist?" *Erzmetall* 35 (1982) 597–604.
62. K. Grjotheim, H. Kvande, K. Matiasovsky: "Addition of LiF and MgF<sub>2</sub> to the Bath of the Hall-Héroult Process", *Light Metals*, March 1983, 397.
63. S. Gershon, B. Shopsin: *Lithium—its Role in Psychiatric Research and Treatment*, Plenum Press, New York–London 1973.
64. F. N. Johnson (ed.): *Lithium Research and Therapy*, Academic Press, London–New York 1974.
65. R. O. Bach (ed.): *Lithium—Current Applications in Science, Medicine and Technology*, John Wiley & Sons, New York 1985, pp. 337–407.
66. W. Sundermeyer, O. Glemser, *Angew. Chem.* 70 (1958) 625.
67. Hoechst AG, DE 3443305, 1986 (F. Meininger, L. Schläfer).  
Mitsubishi Chemical Industries Co. Ltd., EP 216296, 1987 (Y. Narita, H. Takimoto, H. Sano).
68. R. G. Kelleher, M. A. McKervey, P. Vibuljan, *J. Chem. Soc. Chem. Commun.* 1980, 486.
69. J. E. McMurry, *Org. React.* 24 (1976) 187.
70. W. Weppner, W. Welzel, R. Kniep, A. Rabenau, *Angew. Chem.* 98 (1986) 1105–1106.
71. Furukawa Electric Co. Ltd., JP 8259742, 1982.
72. Showa Denko, JP 5957905, 1984; JP 5973411, 1984.
73. J. Raeder: "Der Entwicklungsstand der Kernfusion", *Kernforsch.* 6 (1977) 253.
74. S. B. van der Molen, E. J. Siewers, H. den Uil, M. J. A. A. Goris: "Porous MCFC Component Development at ECN", *International Seminar Fuel Cell Technology and Applications*, Den Haag 1987.
75. J. A. Dean: *Flame Photometry*, McGraw-Hill, New York 1960, pp. 153–160.
76. S. Kallmann: *The Alkali Metals, Treatise on Analytical Chemistry*, vol. I, part II, J. Wiley & Sons, New York 1961.
77. I. Gyenes: *Titration in nichtwässrigen Medien*, Ferdinand Enke Verlag, Stuttgart 1970.
78. J. Weiß: *Handbuch der Ionenchromatographie*, VCH Verlagsgesellschaft, Weinheim 1985.
79. Roskill Info. Services, London: *The Economics of Lithium*, 5th ed., 1987.
80. J. A. Ober: "Lithium", *U.S. Dep. Inter. Bur. Mines Miner. Yearb.* 1986, 1–7.
81. D. J. Kingsnorth: "Lithium Minerals in Glass", *Ind. Miner.*, Jan. 1988, 49–52.
82. K. Kordes, G. Simader, *Fuel Cells and their Applications*, VCH, Weinheim 1996.
83. K. Brandt, *Solid State Ionics* 69 (1994) 173–183.
84. K. Ozawa, *Solid State Ionics* 69 (1994) 212–221.
85. A. Loupy, B. Tchoubar, *Salt Effects in Organic and Organometallic Chemistry*, VCH, Weinheim 1992.
86. J. M. Tarascon, D. Guyomard, *Solid State Ionics* 69 (1994) 293–305.
87. Goldschmidt AG, EP 266633, 1986 (K. Koerner, C. Weitemeyer, D. Wewers).
88. Sabalith®, *Nitrite-Free Heat Transfer Salt*, brochure published by Chemetall GmbH, June 1994.
89. J. M. Tarascon, E. Wang, F.K. Shokoohi, W. R. Kimmon, S. Colson, *J. Electrochem. Soc.* 138 (1991) 2859–2864.
90. G. N. Schrauzer, K.-F. Klippel, *Lithium in Biology and Medicine*, VCH, Weinheim 1991.

# 51 Sodium

GABRIELE HARTMANN, ALFRED KLEMM, LUDWIG LANGE, WOLFGANG TRIEBEL (§§ 51.1–51.12); GIBBERT WESTPHAL (§ 51.13, INTRODUCTION); T. BAUER, GERHARD KRISTEN (§ 51.13.1); WOLFGANG HERDE (§ 51.13.2); WILHELM WEGENER † (§ 51.13.3.1); PETER AMBATELLO (§ 51.13.3.2); BERNARD CLERCX, HELMUT GEYER (§ 51.13.3.3); CHRISTIAN BOIDART, BERNARD EPRON (§ 51.13.3.4); KARL SEEBODE (§ 51.13.4); ULRICH KOWALSKI (§ 51.13.5); FRANZ-RUDOLF MINZ (§ 51.14); CHRISTIAN THIEME (§ 51.15); HELMOLD VON PLESSSEN (§ 51.16); TAKAO MAKI (§ 51.17)

|           |   |      |           |  |      |
|-----------|---|------|-----------|--|------|
| 51.1      | Introduction  | 2054 | 51.13.5.2 | Packaging, Transport, and Storage                | 2094 |
| 51.2      | History   | 2054 | 51.14     | Sodium Hydroxide                                 | 2094 |
| 51.3      | Properties  | 2055 | 51.14.1   | Properties                                       | 2094 |
| 51.4      | Occurrence  | 2059 | 51.14.1.1 | Properties of Sodium Hydroxide                   | 2094 |
| 51.5      | Production  | 2059 | 51.14.1.2 | Properties of Sodium Hydroxide Solution          | 2095 |
| 51.5.1    | Chemical Processes  | 2059 | 51.14.2   | Production                                       | 2096 |
| 51.5.2    | Electrolytic Processes  | 2059 | 51.14.2.1 | Production of Sodium Hydroxide Solution          | 2096 |
| 51.5.2.1  | Development of Molten Salt Electrolysis of NaOH and NaCl        | 2059 | 51.14.2.2 | Production of Solid Sodium Hydroxide             | 2099 |
| 51.5.2.2  | Description and Operation of NaCl Molten Salt Electrolytic Cell | 2061 | 51.14.2.3 | Forming  | 2100 |
| 51.5.2.3  | Properties of the Electrolyte                                   | 2065 | 51.14.2.4 | Specifications                                   | 2100 |
| 51.5.2.4  | Other Electrolytic Processes                                    | 2066 | 51.14.2.5 | Storage, Packaging, and Transportation           | 2101 |
| 51.6      | Safety  | 2066 | 51.14.3   | Uses   | 2101 |
| 51.7      | Uses  | 2067 | 51.14.4   | Safety Precautions                               | 2102 |
| 51.8      | Alloys  | 2069 | 51.14.5   | Economic Aspects                                 | 2102 |
| 51.9      | Packaging and Transport   | 2070 | 51.15     | Sodium Carbonates                                | 2104 |
| 51.9.1    | Sodium Metal  | 2070 | 51.15.1   | Sodium Carbonate                                 | 2104 |
| 51.9.2    | Transport Regulations   | 2070 | 51.15.1.1 | Properties                                       | 2104 |
| 51.9.3    | Break-Bulk Packaging  | 2071 | 51.15.1.2 | Sodium Carbonate Minerals                        | 2105 |
| 51.9.4    | Portable Tanks  | 2072 | 51.15.1.3 | Production                                       | 2106 |
| 51.10     | Quality Specifications and Analysis                             | 2072 | 51.15.1.4 | Quality Specifications                           | 2117 |
| 51.11     | Health and Safety   | 2073 | 51.15.1.5 | Producers  | 2118 |
| 51.12     | Economic Aspects  | 2073 | 51.15.1.6 | Storage and Transport                            | 2119 |
| 51.13     | Sodium Chloride   | 2073 | 51.15.1.7 | Uses   | 2119 |
| 51.13.1   | Properties  | 2074 | 51.15.1.8 | Toxicology                                       | 2120 |
| 51.13.2   | Formation and Occurrence of Salt Deposits                       | 2076 | 51.15.2   | Sodium Hydrogencarbonate                         | 2120 |
| 51.13.3   | Production  | 2077 | 51.15.2.1 | Properties                                       | 2120 |
| 51.13.3.1 | Mining of Rock Salt   | 2077 | 51.15.2.2 | Production                                       | 2121 |
| 51.13.3.2 | Production of Crude Brine by Mining Methods                     | 2080 | 51.15.2.3 | Uses and Quality Specifications                  | 2121 |
| 51.13.3.3 | Controlled Solution Mining                                      | 2083 | 51.16     | Sodium Sulfates                                  | 2121 |
| 51.13.3.4 | Production of Sea Salt  | 2086 | 51.16.1   | Sodium Sulfate                                   | 2121 |
| 51.13.4   | Production of Pure Salt by Evaporation of Brine                 | 2089 | 51.16.1.1 | History and Natural Occurrence                   | 2121 |
| 51.13.4.1 | Purification of Crude Brine                                     | 2090 | 51.16.1.2 | Properties                                       | 2122 |
| 51.13.4.2 | Evaporation of Brine  | 2090 | 51.16.1.3 | Extraction and Production                        | 2123 |
| 51.13.4.3 | Recrystallization   | 2091 | 51.16.1.4 | By-product Sodium Sulfate                        | 2129 |
| 51.13.4.4 | Other Process Steps   | 2092 | 51.16.1.5 | Uses   | 2132 |
| 51.13.4.5 | Salt Quality  | 2092 | 51.16.1.6 | Occupational Health and Environmental Protection | 2132 |
| 51.13.5   | Economic Aspects  | 2092 | 51.16.1.7 | Economic Aspects                                 | 2132 |
| 51.13.5.1 | Commercial Grades   | 2092 | 51.16.2   | Sodium Hydrogensulfate                           | 2132 |
|           |   |      | 51.17     | Sodium Benzoate                                  | 2133 |
|           |   |      | 51.18     | References                                       | 2133 |



## 51.1 Introduction

Sodium is the best-known alkali metal. The amount of sodium metal produced industrially exceeds that of all other alkali metals. It is a member of group 1 of the periodic table, with the relative atomic mass 22.9898 and the atomic number 11.

Sodium has only one naturally occurring isotope,  $^{23}\text{Na}$ . Several artificial isotopes are also known [1]. The isotope  $^{24}\text{Na}$  is used as a tracer in industrial and medicinal applications.

Few basic chemicals are used in as many areas as sodium metal. Elemental sodium can be considered both a fine chemical whose properties make it indispensable for industrial applications ranging from pharmaceuticals to heavy inorganic chemicals, and a readily liquefied metal with a wide range of metallurgical and physical uses. A large number of products derived from sodium metal are used in the chemical industry.

## 51.2 History

The German name *Natrium* is derived from the Egyptian *neter*, meaning sodium carbonate [2–4], while the English name sodium is derived from soda [3]. Sodium was discovered in 1807 by DAVY, who electrolyzed molten sodium hydroxide in a platinum dish, by contacting it with a platinum wire using a voltaic pile as the source of electricity [3].

However, this electrolytic process could not be used for industrial production at that time, because no economic source of direct current was available. Powerful d. c. generators first became available after the discovery of the dynamo principle by W. SIEMENS in 1867.

The history of the industrial production of sodium, which extends over more than 100 years, can be divided into four periods, in which four different processes were used [5].

Thermochemical reduction processes were used between 1854 and 1890. A mixture of sodium carbonate, wood charcoal or coal, and quicklime was heated to  $> 1100\text{ }^\circ\text{C}$ , and the

sodium vapor formed was condensed (SAINTE-CLAIRE DEVILLE, Paris, 1854). An annual production of 5–6 t of sodium was achieved by this process. In a later development, sodium carbonate was replaced by sodium hydroxide, and the wood charcoal or coal by a mixture of iron and coal (CASTNER, 1886). Using this process, the Aluminium Company Limited in Oldbury produced ca. 150 t/a sodium between 1888 and 1890 [4].

Between 1891 and 1920, sodium was produced by electrolysis of molten sodium hydroxide, to which sodium chloride and sodium carbonate were added to lower the melting point (Castner process). The Castner process [6] was the only important industrial process for producing sodium during this period.

In the 1900s, attempts were made in Switzerland (Ciba), Germany (Degussa), and the United States (Rössler & Hasslacher Chemical Co.) to use the cheaper starting material sodium chloride in a molten salt electrolysis process. In 1921, DOWNS succeeded in constructing a cell for electrolyzing sodium chloride [7], the basic principle of which is still used today. The electrolyte used from ca. 1925 onward for industrial production was a mixture of sodium chloride and calcium chloride. Since ca. 1950, a modified Downs cell has been used, with an electrolyte consisting of a ternary mixture of  $\text{NaCl}$ ,  $\text{BaCl}_2$ , and  $\text{CaCl}_2$ . This process has since become established worldwide.

The industrial use of sodium has also undergone a change. The only demand for large-scale production of sodium in the mid-1800s came from the aluminum industry, where it was used for reducing aluminum trichloride. However, around 1890, aluminum producers began to switch to a molten salt electrolysis process. Sodium was also used in the production of sodium cyanide (for extracting gold from its ores) and sodium peroxide. It was later used in the production of lead-containing antiknock agents for gasoline and special metals such as titanium.

## 51.3 Properties

**Physical Properties.** The properties of sodium are directly related to its structure [8]. The electronic configuration of sodium is  $1s^2 2s^2 2p^6 3s^1$ . The atomic volume is therefore large, and the cohesive forces in the sodium lattice are relatively low. Thus, like all alkali metals, sodium has a lower density than the alkaline-earth metals, as well as lower hardness; lower melting and boiling points; and lower energies of sublimation, vaporization, and dissociation [5, 9].

Sodium crystallizes from the melt with a body-centered cubic crystal lattice. It has typical metallic properties, including high thermal and electrical conductivity, the electrical conductivity of sodium at  $20\text{ }^\circ\text{C}$  being about one-third that of copper. It is liquid over a wide temperature range from  $97.8$  to  $881.4\text{ }^\circ\text{C}$  and has a fairly low vapor pressure, which is an important requirement for production in an electrolytic cell [10].

Alkali metals give characteristic flame coloration. Their outer electrons can easily be raised to an excited state, which is the basis for their analytical determination by flame photometry and atomic absorption spectroscopy. Sodium and sodium salts color the flame of a Bunsen burner yellow. The sodium D doublet at  $589$  and  $589.6\text{ nm}$  is due to the  $3s^1-3p^1$  transition in sodium atoms formed by the reduction of  $\text{Na}^+$  in the flame [9].

Sodium is monoatomic in the vapor state, although dimers and tetramers have also been reported [10].

Some physical properties of sodium are listed below [8, 10]:

|                                   |                               |
|-----------------------------------|-------------------------------|
| Atomic number                     | 11                            |
| Relative atomic mass              | 22.98977                      |
| Melting point                     | $97.83\text{ }^\circ\text{C}$ |
| Heat of fusion                    | $113\text{ J/g}$              |
| Volume expansion on melting       | $2.7\%$                       |
| Boiling point                     | $881.4\text{ }^\circ\text{C}$ |
| Heat of vaporization              | $3750\text{ J/g}$             |
| Atomic radius in metallic lattice | $189.6\text{ pm}$             |
| Ionic radius                      | $95-98\text{ pm}$             |
| Ionization potential              | $5.139\text{ V}$              |
| Standard electrode potential      | $2.714\text{ V}$              |

|  |                                       |
|--|---------------------------------------|
| Electrical resistivity at $20\text{ }^\circ\text{C}$ | $4.77 \times 10^{-8}\ \Omega\text{m}$ |
| Critical temperature                                 | $2508.7 \pm 12.5\text{ K}$            |
| Critical pressure                                    | $25.64 \pm 0.02\text{ MPa}$           |
| Critical density                                     | $206\text{ kg/m}^3$                   |
| Specific heat capacity at $20\text{ }^\circ\text{C}$ | $1.22\text{ Jg}^{-1}\text{K}^{-1}$    |
| Thermal conductivity at $20\text{ }^\circ\text{C}$   | $132.3\text{ Wm}^{-1}\text{K}^{-1}$   |
| Density  |                                       |
| at $20\text{ }^\circ\text{C}$                        | $0.968\text{ g/cm}^3$                 |
| at $120\text{ }^\circ\text{C}$                       | $0.927\text{ g/cm}^3$                 |

The density (kilograms per cubic meter) of solid sodium in the range  $273-370.98\text{ K}$  is given by the following equation [8]:

$$\rho_r = 972.5 - 20.11 \times 10^{-2}(T - 273.15) \times 10^{-4}(T - 273.15)^2$$

For liquid sodium in the range  $370.98-1644.24\text{ K}$ , the following equation applies [8]:

$$\rho_r = 1011.8 - 0.22054T - 1.9226 \times 10^{-5}T^2 + 5.637 \times 10^{-9}T^3$$

The specific heat capacity ( $\text{Jg}^{-1}\text{K}^{-1}$ ) as a function of temperature at  $273.15-370.98\text{ K}$  is given by [8]

$$c_p = 1.1987 + 6.4894 \times 10^{-4}(T - 273.15) + 1.053 \times 10^{-5}(T - 273.15)^2$$

In the range  $370.98-1173.15\text{ K}$ , the following equation applies [8]

$$c_p = 1.4361 - 5.8024 \times 10^{-4}(T - 273.15) + 4.621 \times 10^{-7}(T - 273.15)^2$$

The thermal conductivity ( $\text{Wm}^{-1}\text{K}^{-1}$ ) from  $370.98$  to  $1173.15\text{ K}$  is given by [8]

$$\lambda = 91.8 - 4.9 \times 10^{-2}(T - 273.15)$$

The vapor pressure (kilopascals) at  $300-2500\text{ K}$  is [8]

$$\log p = 10.182516 - 5693.8776/T - 1.0948 \log T + 8.5874946 \times 10^{-3}T$$

The viscosity ( $\text{mPa}\cdot\text{s}$ ) at  $< 773\text{ K}$  is given by [8]

$$\eta = (0.1235 \pm 0.0018) \times (\rho/1000)^{1/3} \times e^{(697 \pm 9)/(1000T)}$$

Above  $773\text{ K}$ , the equation is [8]

$$\eta = (0.0815 \pm 0.0013) \times (\rho/1000)^{1/3} \times e^{(1040 \pm 19)/(1000T)}$$

The surface tension (newtons per meter) in the range  $370.98-1300\text{ K}$  is given by [8]

$$\sigma = 206.7 \times 10^{-3} - 1.0 \times 10^{-4}(T - 273.15)$$

Figure 51.1 shows some properties of sodium as a function of temperature.

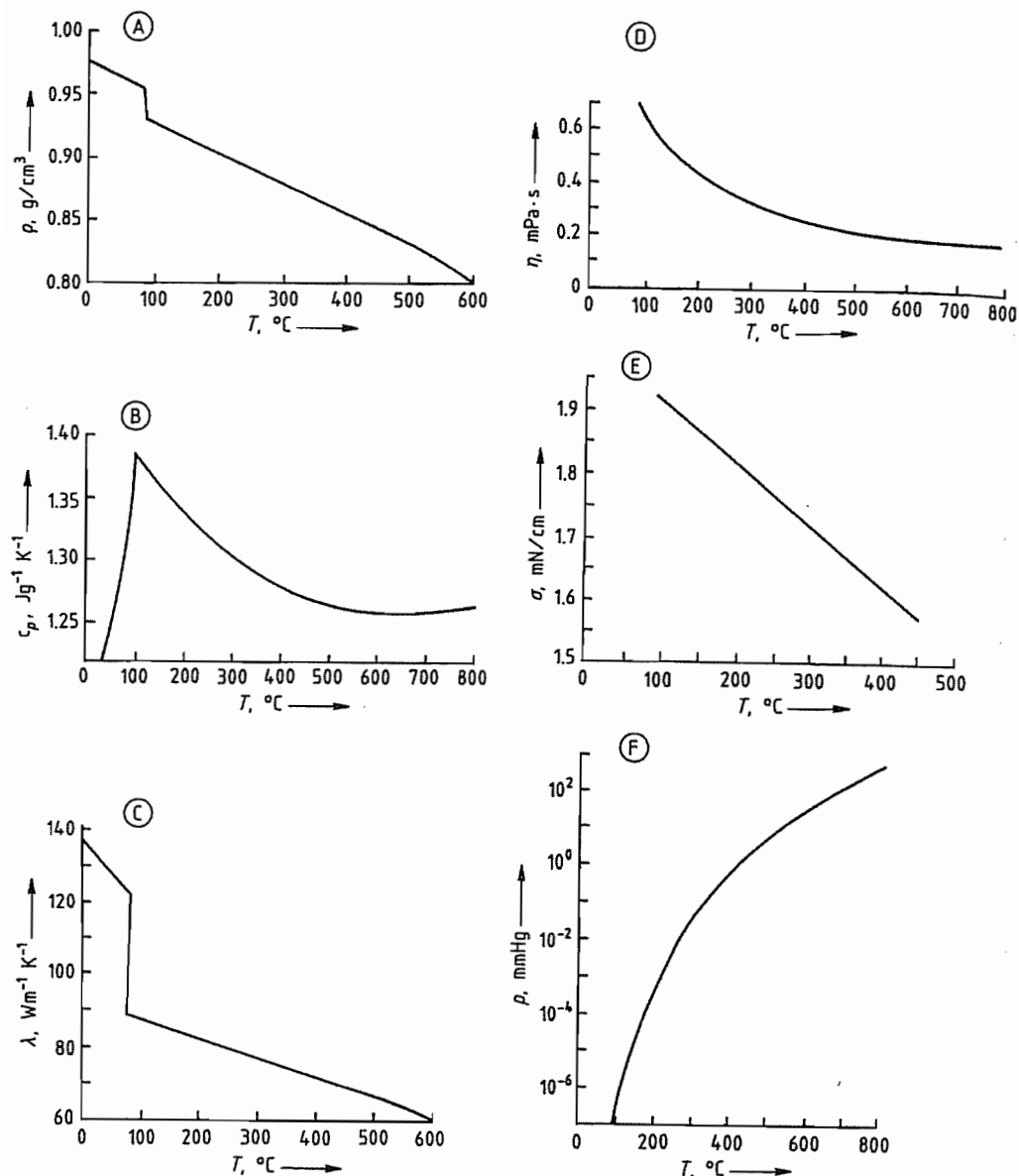
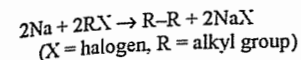
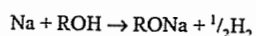
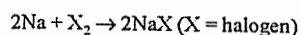
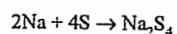
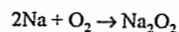
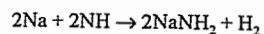
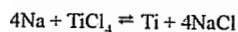
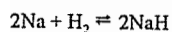

Figure 51.1: Some properties of sodium as a function of temperature [11]. A) Density; B) Specific heat capacity; C) Thermal conductivity; D) Viscosity; E) Surface tension; F) Vapor pressure.

**Chemical Properties.** The reactivity of sodium can be illustrated by the following equations [12, 13]:



The high reactivity of sodium is a result of its electronic configuration [14]. Sodium, like the other alkali metals, has only one s electron in its outer shell, which is very weakly bound due to shielding from the atomic nucleus provided by the completely filled rare gas shells.

- Sodium reacts with hydrogen at ca. 200–300 °C to form sodium hydride. In NaH, hydrogen is present as hydride ion. In organic syntheses, sodium hydride has little reducing action [15], its most important chemical property being high basicity. Sodium hydride reacts as a strong base not only with all acids, but also with all organic and inorganic compounds that contain an active hydrogen atom. Sodium hydride is more strongly basic than sodium amide [16]. However, in molten NaOH or eutectic salt baths, NaH behaves as a strong reducing agent toward metallic salts and oxides [17]. The system Na–H<sub>2</sub>–NaOH–Na<sub>2</sub>O has been investigated extensively [18, 19].

- Titanium was first produced in large quantities in 1910 by HUNTER, who reacted titanium tetrachloride with sodium in an evacuated steel bomb. In 1956, ca. 1500 t of titanium sponge, representing ca. 10% of the total world output, was produced by ICI by reducing titanium tetrachloride with sodium [20]. Also, Reactive Metals, Inc., of Ashtabula, Ohio, until recently, used sodium as the reducing agent in the production of titanium. However, by far the largest amount of titanium has been produced by the magnesium-based Kroll process. More recently, the electrolysis of TiCl<sub>4</sub> has become important.

The Hunter process is representative of many reactions in which the halides of most of the metals in periods 4–6 of the periodic table can be reduced with sodium to the metal, with formation of the corresponding sodium salt. Examples include the production of aluminum by using sodium as the reducing agent (Deville and Bunsen process, 1854) [4] and of thorium from thorium tetrachloride [4, 21–23] or

K<sub>2</sub>ThCl<sub>6</sub> [24]. The elements potassium, beryllium, magnesium, boron, and aluminum can also be produced by this method. The reduction of KCl by sodium appears to go against the normal order of reactivity (K > Na). At 850–880 °C, the following reaction takes place:

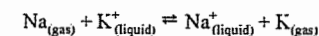

Since potassium is more volatile, it is more readily distilled, so the equilibrium is shifted to the right and the reaction proceeds [9].

- Sodium amide is produced industrially by the reaction of molten sodium with ammonia at 300–400 °C.

Sodium dissolves in liquid ammonia to give a blue color that changes to a coppery red with increasing concentration. Solutions of alkali metals in liquid ammonia are powerful and selective reducing agents. Aromatic systems are reduced smoothly to cyclic mono- or dialkenes, and alkynes are stereospecifically reduced to *trans*-alkenes [9].

Sodium does not react with molecular nitrogen under normal conditions. Hence, nitrogen is a suitable protective gas, even at high temperature, for the production, storage, and transport of sodium [10].

Sodium azide, NaN<sub>3</sub>, can be prepared by the reaction of dinitrogen oxide with sodium amide at 200 °C. The existence of Na<sub>3</sub>N is very doubtful. The heavier alkali metals do not appear to form compounds of this type, possibly for steric reasons [9].

Prior to the 1960s (i.e., before modern catalytic methods for producing hydrogen cyanide became available [12]), sodium cyanide was produced via sodium amide and sodium cyanamide by the Castner process [12]:

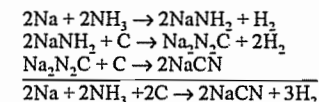

Metallic silver and gold form complexes with NaCN in a smooth reaction under mildly oxidizing conditions. This is used in the extraction of these metals from ores or gold-bearing sand [12].

With carbon, sodium forms compounds of the acetylide type,  $M_2C_2$ , and with graphite it forms a layered compound [8]. Sodium acetylide can be produced by the reaction of sodium with acetylene or by the thermal decomposition of  $NaHC_2$  in a vacuum. Sodium acetylide can be used in the preparation of alkynes.

The reaction between graphite and sodium gives an intercalation compound with the approximate formula  $C_{64}Na$  [8].

Sodium formate or oxalate can be produced in the reaction between carbon dioxide and sodium. Burning sodium reacts explosively with solid carbon dioxide; thus  $CO_2$  extinguishers are unsuitable for sodium fires [10]. Alkali metals in liquid ammonia react with carbon monoxide to form colorless crystals of  $Na_2C_2O_2$ , which contain linear groups,  $NaOC \equiv CNa$ , linked together to form chains [9].

• Sodium reacts with oxygen to form the following oxides: monoxide ( $Na_2O$ ), peroxide ( $Na_2O_2$ ), and hyperoxide ( $NaO_2$ ). The ozonide  $NaO_3$  is also known [25].

The reactions to form the monoxide and the peroxide are exothermic. The peroxide is manufactured in a rotating drum reactor. In the first stage, sodium reacts with air to form sodium monoxide, which reacts with oxygen or oxygen-enriched air in the second stage to form sodium peroxide [25].

The structure and chemical properties of the oxygen compounds of alkali metals have been investigated thoroughly [26].

In normal atmospheric air, molten sodium can ignite at  $> 115^\circ C$ , but higher temperature is necessary in dry air. Combustion is exothermic, with the evolution of much smoke, and an intense white-yellow light is emitted with the formation of  $Na_2O$  and  $Na_2O_2$  [10].

Sodium reacts with water to form sodium hydroxide and hydrogen. If the hydrogen evolved mixes with air, the gas mixture formed can explode with great violence [10]. The reaction of excess sodium with high-pressure steam in the absence of air gives sodium hydroxide and sodium hydride [8].

The heats of reaction of the individual reaction steps are given below [8]:

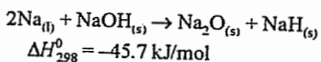
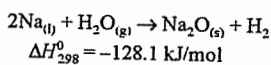
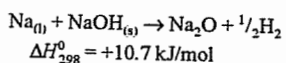
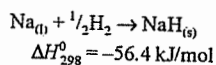
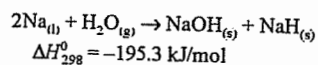
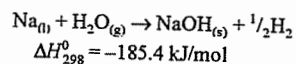
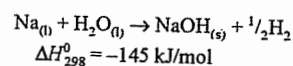

• Molten sodium reacts with stoichiometric amounts of molten sulfur under an inert atmosphere to form disodium tetrasulfide.

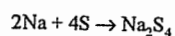

Disodium tetrasulfide is used industrially for the production of organofunctionalized silanes [27] by reaction with 3-chloropropyltrialkoxysilanes. In a nucleophilic reaction, the tetrasulfide anion displaces the chlorine atoms and links two propyltrialkoxysilane molecules with formation of a sulfur bridge [27].

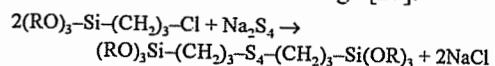

• Halogens react with sodium with varying degrees of vigor. With fluorine, ignition takes place at room temperature, but no reaction occurs in liquid chlorine. With gaseous, dry chlorine, negligible reaction takes place at room temperature, but molten sodium burns in a stream of chlorine to form sodium chloride. This reaction takes place to a small extent in the Downs cell. Sodium is fairly stable toward bromine. Sodium and iodine can be melted together without reaction [10].

• Lower and primary alcohols react readily with sodium to form alkoxides. Higher and branched alcohols generally react very slowly due to the decreasing acidity of the hydroxyl group. The reaction velocity can be increased by raising the temperature and

by using finely divided sodium. Alkoxides are condensation agents of high basicity, used in the alkylation of carbon, nitrogen, and oxygen atoms (e.g., the mono- and dialkylation of malonic esters, acetoacetic esters, cyanoacetic esters, benzyl nitrile) and for base-catalyzed ring closure reactions to form nitrogen-containing heterocyclic compounds. Alkoxides are used as synthetic building blocks in the Williamson ether synthesis [11].

• The reactions of alkali metals with alkyl halides (Wurtz reaction) are heterogeneous and probably very complex [28]. Alkanes are formed when the alkylsodium compound initially formed displaces the halogen atom from an alkyl halide molecule:

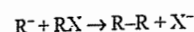
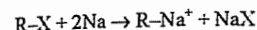

Organometallic compounds of group IV A metals can be prepared by a variation of this synthetic method. For example, tetraethyllead can be prepared by reacting chloroethane with a lead-sodium alloy [29]:

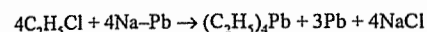

## 51.4 Occurrence

Sodium is strongly electropositive, very reactive, and does not occur in nature in the elemental state, but always in cationic form in salts. Sodium is the seventh element in order of abundance in the Earth's crust (2.27%). It occurs in several minerals in association with other alkali metals. Extensive deposits of relatively pure sodium salts were formed by the evaporation of prehistoric lakes, a process that can still be observed [e.g., in the Great Salt Lake (Utah) and the Dead Sea].

Industrially important naturally occurring sodium compounds include rock salt (sodium chloride), trona (sodium carbonate), Chile saltpeter (sodium nitrate), mirabilite (sodium sulfate), and borax or kernite (sodium borate). Sodium chloride ( $NaCl$ ) is the most used raw material in the inorganic chemical industry [9].

## 51.5 Production

### 51.5.1 Chemical Processes

Sodium can be obtained from many of its compounds by high-temperature reduction [4]. In the older thermochemical methods, sodium carbonate or sodium hydroxide was reacted with charcoal or coal, sulfur, or iron. Other compounds of sodium, such as the chloride, sulfide, sulfate, and cyanide were also used. A serious disadvantage of thermochemical methods was that reverse and secondary reactions occurred. Despite these problems, patents were applied for, covering many variations of the thermochemical methods of production [10]. In a Du Pont patent, sodium carbonate or sodium hydroxide was reduced with coal. The gases formed in the reaction were passed through molten tin, which absorbed the sodium vapor. Sodium was then recovered from the tin in an additional process step. According to a patent of Pechiney S. A.,  $NaCl$  vapor is passed over calcium carbide at  $800-1000^\circ C$ , and the sodium formed is collected in oil. In a Dow Chemical Co. process, sodium carbonate is reduced with coal at  $> 1200^\circ C$ . The sodium vapor formed is condensed in liquid sodium [10].

### 51.5.2 Electrolytic Processes

#### 51.5.2.1 Development of Molten Salt Electrolysis of $NaOH$ and $NaCl$

Using the same principle by which DAVY discovered sodium, CASTNER developed a process for producing the metal on a large scale from molten sodium hydroxide in an electrolytic cell (Figure 51.2). This process was operated at Niagara Falls (United States) and Rheinfelden (Germany), and was the only practical method for sodium production from 1881 to the mid-1920s. Cheap hydroelectric power was available at both locations.

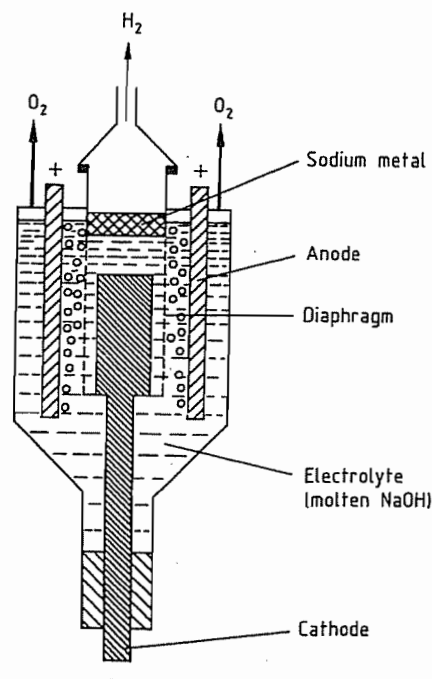
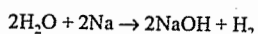
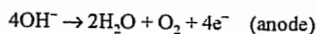
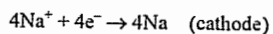
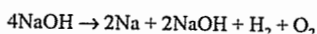

Figure 51.2: Production of sodium by the Castner process (1891).

The Castner process yields sodium, hydrogen, and oxygen:



The overall reaction is:



Thus the current efficiency cannot exceed 50%. In practice, current efficiencies of < 45%, were achieved.

Before sodium can be produced by this method, sodium hydroxide must first be obtained (e.g., by electrolysis of aqueous sodium chloride). Much research was therefore aimed at producing sodium by direct electrolysis of sodium chloride, which has the following advantages over sodium hydroxide as a starting material:

- Higher current efficiency during sodium production
- Cheaper raw material

- Easier handling
  - Production of chlorine as by-product
- Its disadvantages are:

- The need to install a plant for chlorine purification and sometimes also for chlorine liquefaction
- Increased technical problems associated with chlorine
- Higher melting point

Many cells were developed at this time, but only the Downs cell solved the problems encountered with other cells. With the Downs cell, the foundations were laid for large-scale sodium production. Along with the Hall aluminum cell and the Dow magnesium cell, this is one of the most successful molten salt electrolysis cells ever developed [30].

In the Castner cell (Figure 51.2) a cylindrical nickel anode surrounds the copper cathode concentrically. If NaOH is replaced by a molten salt containing NaCl, the collection and containment of the chlorine evolved cause problems, which are solved only when the positions of the anode and cathode are reversed, as in the Downs cell in which the anode is surrounded concentrically by the cathode.

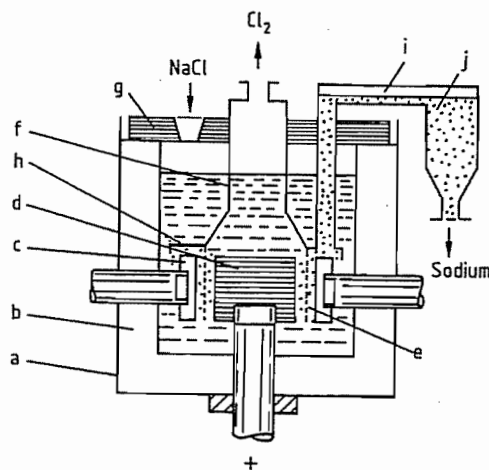
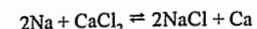

Figure 51.3: The Downs cell (original form): a) Steel vessel; b) Ceramic lining; c) Iron cathode; d) Graphite anode; e) Wire gauze diaphragm; f) Dome for collecting chlorine gas; g) Insulating lid; h) Channel with riser pipe for collecting sodium; i) Sodium overflow; j) Sodium holding vessel.

Figure 51.3 is a schematic of the Downs cell in its original form [13, 31]. It consists of a lined steel vessel in which the graphite anodes pass through the floor, and the two electrical conductors connected to the cathodes pass through the walls. The anode is surrounded by the cylindrical iron cathode.

The Downs process used a mixture of 60%  $\text{CaCl}_2$  and 40%  $\text{NaCl}$  at an operating temperature of 560–585 °C. This composition represents a compromise between the melting point of the salt mixture and the sodium content. The eutectic mixture, which contains 66.8%  $\text{CaCl}_2$  and 33.2%  $\text{NaCl}$ , melts at ca. 505 °C. Although increasing the  $\text{CaCl}_2$  content reduces the melting point of the binary mixture, it also decreases the concentration of sodium in the cathode space due to the equilibrium



The operating temperature of ca. 580 °C is well below the temperature of maximum solubility of sodium in the molten salt. The density of the salt is 1.89–1.94 g/cm<sup>3</sup>. Along with sodium metal, calcium (ca. 3.5–4%) is deposited at the cathode. Because of the high melting point of calcium (804 °C) and its low solubility in sodium, the alloy phase Na–Ca can accumulate in the sodium and cause blockages in the equipment for continuous removal of sodium from the cell. These solid deposits must be scraped off the walls of this equipment. Most of the calcium can react with NaCl in the melt (by the above reversible reaction), again forming calcium chloride. A further quantity of calcium is removed from the sodium by filtration at 110 °C. The sodium purified in this way contains < 400 ppm calcium. Some of the early cell types used for sodium production (e.g., the Castner, Ciba, McNitt, and Downs cells) are described in detail in [4, 13].

### 51.5.2.2 Description and Operation of NaCl Molten Salt Electrolytic Cell

Large sodium production plants have 40–50 d.c. electrolytic cells connected in series to

achieve optimum efficiency. The voltage of each cell depends on the operating conditions (current, temperature, melt composition, sodium production rate) and changes with time.

Today, electrolytic cells are usually operated at up to 45 kA, with outputs of up to 800 kg/d sodium. For problem-free operation, the individual electrolytic cells, with their associated equipment, must be electrically insulated from neighboring cells and from the ground. The graphite used to make the anodes in the electrolytic cell is resistant to nascent chlorine in the chloride melt even at high temperature, and its electrical conductivity is adequate at the operating temperature. However, all oxygen-containing compounds must be removed from the salts used to prevent corrosion of the graphite. Salts of heavy metals and salts of aluminum and magnesium also cause problems in molten salt electrolysis.

Because of the requirement for high-purity raw materials, extensive facilities are required to purify the salt used in the electrolytic process [5]. Sodium chloride is first dissolved in water to give a saturated brine. Barium chloride and sodium carbonate are added, mainly to remove  $\text{CaSO}_4$ . The precipitate of  $\text{BaSO}_4$  and  $\text{CaCO}_3$  forms a sediment together with clay minerals present in the crude salt. The filtered solution is then evaporated to crystallize the salt, which is recovered by centrifugation and dried to a water content of < 600 ppm, which is important for optimum operation of the electrolytic cells [5]. A process for the purification of sodium chloride by recrystallization alone, without the use of precipitating agents, has been reported recently [32]. A schematic of a sodium production process is given in Figure 51.4.

At the melting point of sodium chloride (808 °C), chlorine would severely corrode all the cell components that come in contact with it. Also, the vapor pressure of sodium is high at this temperature (50 kPa), and its solubility in molten salt is also high (4.2%). Therefore lower melt temperatures must be used. A ternary salt mixture is normally employed ( $\text{NaCl}$ – $\text{BaCl}_2$ – $\text{CaCl}_2$ ). The temperature of the molten salt in the cell is ca. 600 °C.

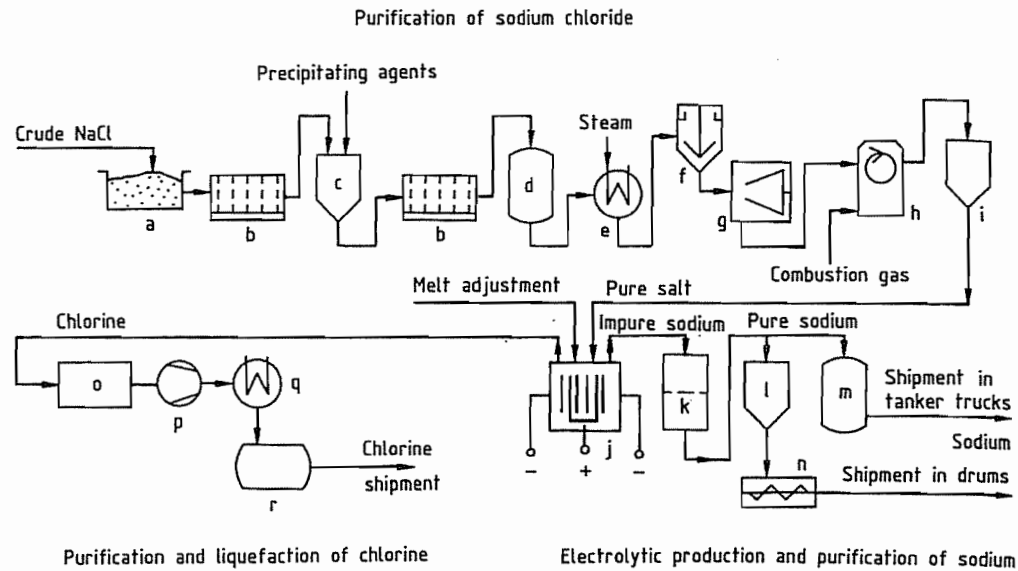

**Figure 51.4:** Flow sheet of sodium production: a) Dissolution vessel; b) Filter; c) Precipitation vessel; d) Vessel for pure brine; e) Evaporator; f) Thickener; g) Centrifuge; h) Rotary dryer; i) Pure salt bunker; j) Electrolysis cell; k) Sodium filter; l) Sodium storage; m) Sodium tank; n) Casting; o) Chlorine purification; p) Chlorine compressor; q) Liquefier; r) Chlorine storage vessel.

From this molten salt mixture, ca. 1% calcium is deposited on the cathode with the sodium. The crude sodium removed from the cell also contains 0.3% calcium oxide, 0.3% sodium oxide, and small quantities of entrained molten salt. A product of marketable quality [10] is made by cooling the sodium to ca. 120 °C and removing the impurities that separate with the aid of a candle filter equipped with gauze. The filter cake obtained consists of calcium, sodium, chlorides, and oxides. Various methods of recovering calcium or calcium alloys from the filter cake have been proposed, but none has had commercial success [1, 33, 34].

In modern cells (Figure 51.5) the cathode and anode are subdivided into four pairs of electrodes. Four steel tubes, welded together, surround the four cylindrical graphite anodes concentrically. The cell design has been developed over the course of time [13, 35–40].

The anodes usually take the form of a hollow cylinder with slits in the wall [41, 42]. Al-

ternatively, anode blocks can be made with conical central holes, which increases the proportion of graphite and decreases the resistance along the length of the anode [43].

The four steel cathodes are connected to the electrical supply by two conducting rods that pass through the side walls of the cell. The annular gap between the anode and the cathode is < 50 mm wide. A cylindrical iron mesh is placed in this gap, forming a diaphragm to separate the products, sodium and chlorine. The cylindrical diaphragm is attached to a device that collects sodium and chlorine from the four electrode pairs. Above the cathode space (between the cathode and the diaphragm) is a channel with a closed roof to collect the liquid sodium that rises through the melt in the form of droplets. Four shafts lead gaseous chlorine from the four anode spaces upward into a dome. Chlorine collects in the dome above the surface of the melt and is removed via an outlet at the top.

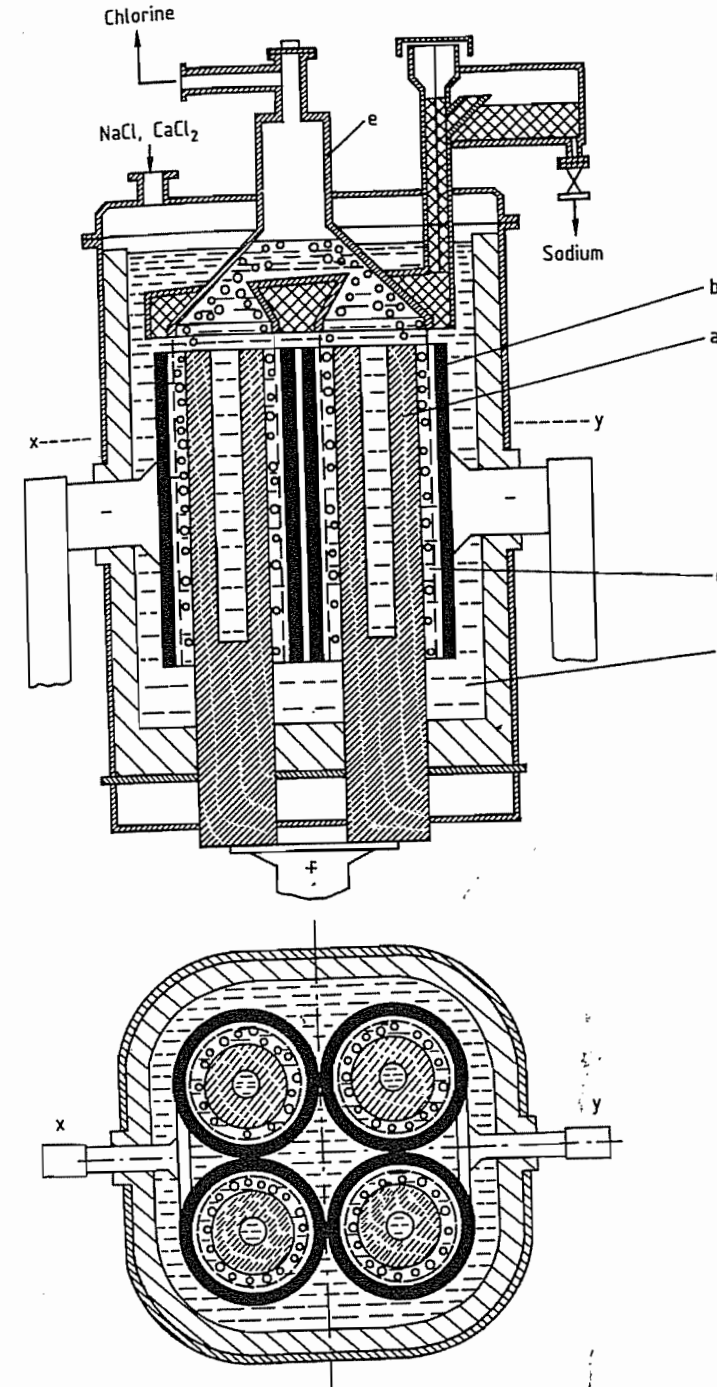

**Figure 51.5:** Modified Downs cell: a) Anode; b) Cathode; c) Molten salt; d) Diaphragm; e) Chlorine dome.

The chlorine pipe leading from the top of the dome is fitted with an access cover that is used to monitor the extraction of chlorine from the cell into the collection device. This cover can be provided with a tongue-and-groove seal to prevent intake of air into the chlorine [44].

The roof of the sodium-collecting device usually slopes upward, so that sodium flows smoothly into the vertical riser pipe. The device for collecting the sodium and chlorine may also include a tube for promoting circulation of the melt. The chlorine bubbles that form and rise at the graphite anodes improve the circulation of the melt in the anode space. The rising gas bubbles cause the surface of the melt to rise in the chlorine collection hood, so that the salt level is higher inside the hood than outside. Circulation of the molten catholyte is improved by the upward flow of the sodium. Downward flow of the catholyte takes place by natural convection at the inactive outer walls of the cathodes. By including a circulation tube, the flow of the catholyte can be improved, enabling the electrolyte from the chlorine-collecting hood to flow downward into the central cathode space [45].

Sodium flows from the riser pipe of the collecting device into a closed collection vessel [6]. The calcium dissolved or suspended in the sodium separates as a solid on the inner walls of the riser pipe. Blockage is prevented by means of an agitator inside the riser pipe that scrapes calcium from the walls. Since the density of calcium is higher, it sinks down through the sodium to the salt level, where partial reaction with NaCl of the ternary salt mixture occurs to form calcium chloride and sodium. Various designs of this agitator mechanism in the riser pipe have been described [46, 47]. Calcium, oxides (e.g.,  $\text{Na}_2\text{O}_2$  and  $\text{CaO}$ ), and entrained melt settle at the bottom of the collection vessel, which is therefore equipped with a stirrer [48]. A design has also been described in which this stirrer is combined with the agitator in the riser pipe [49].

A characteristic of another possible design [49] is, that the open overflow is replaced by

an overflow pipe between riser pipe and collecting vessel (Figure 51.5).

If the overflow pipe is at the correct height, the hydrogen liberated occasionally at the cathode and the chlorine diffusing into the cathode space do not enter the collector. The gases that collect above the sodium in the gas space of the riser pipe are removed by a stream of inert gas (e.g., nitrogen) [50].

An overview of the procedures for starting up a Downs cell is given in [51].

The salt used for the initial melting operation can be a solid salt mixture or a powdered, solidified melt. Melting is achieved by short-circuiting the electrodes with so-called starter blocks. A number of these starter blocks are wedged between the anode and cathode, and the cell is then filled with salt mixture. In order to melt the mixture, a low electric current is passed through the cell. When sufficient salt has melted, the starter blocks are removed, the current is increased to the normal operating level, and the diaphragm is inserted.

In an improved technique, the cell is filled with solid powdered electrolyte or salt mixture until the level is just below the top of the electrodes [52]. The part of the cathode that is not covered is then heated to a temperature well above the melting point of the salt mixture. If a small amount of liquid melt is introduced from another cell, a low electric current can be passed between the electrodes. While solid salt mixture is being added, the electric current is slowly increased until the cell is filled with molten salt mixture to the correct height. The diaphragm is then introduced. A further improvement in the procedure for starting up a cell has now been developed, in which the cell is preheated, and sufficient liquid melt from neighboring cells is added to enable the diaphragm to be introduced and the electric current to be applied immediately to the cell [51]. Sodium production can then begin without the need for the complicated procedures described above.

Cells normally used today have a capacity of ca. 8.4 t molten salt with a density of ca. 2.7  $\text{g/cm}^3$ . Cells have a working life of about three years. They are normally taken out of commis-

sion when the cell voltage and hence the energy consumption become too high due to wear of the anodes. Operating data for a Downs molten salt cell are [5]:

|                                  |                    |
|----------------------------------|--------------------|
| Operating temperature            | 590–610 °C         |
| Lifetime of cell                 | 1100–1200 d        |
| Cell voltage                     | 6.5–7 V            |
| Cell current                     | ≤ 45 kA            |
| Current efficiency               | 80–90%             |
| Consumption of electrical energy | 9.8–10.5 kWh/kg Na |

The voltage required for the electrolysis of sodium chloride is ca. 3.4 V, which is ca. 50% of the cell voltage.

In the course of a working life, various changes in the operating conditions of the Downs cell take place that lead to increased energy consumption. These changes are mainly a result of loss of graphite from the anodes due to corrosion and erosion, and buildup of impurities in the melt, leading to the accumulation of precipitated material on the cell floor [53]: A cell that consumes ca. 280 kW per day to produce 700 kg sodium uses ca. 116 kW for decomposing the NaCl to sodium and chlorine, which corresponds to a power efficiency of ca. 41%. Heating the charge of NaCl from room temperature to the operating temperature requires 9.9 kW, and an additional 11.1 kW is required for melting, amounting to ca. 8% of the total power consumption. To maintain a constant melt temperature, a cooling power of 143 kW is required (i.e., ca. 51% of the total power consumption). The difficulty in operating a cell consists in maintaining an optimum balance of the continually changing rate of heat production due to the internal resistance of the cell, recombination of sodium and chlorine to form sodium chloride, and the rate of removal of excess heat. Here, care must be taken that the flow pattern and hence the cell resistance are not disturbed by the adjustments made to control the cooling [53].

Electricity consumption figures for large installations for the production of sodium by molten salt electrolysis are given in [54]. The consumption of electrical energy for the electrolysis is 9.8–10.5 kWh/kg pure sodium, depending on the length of time that the cell has been in operation. If the associated equipment

(ventilation, heating of vessels, and equipment) is included, this increases to 11.5–12.0 kWh/kg pure sodium. If a plant for purifying the raw salt and a plant for the purification and liquefaction of the chlorine produced is taken into account, the total energy consumption is 12.0–13.0 kWh/kg pure sodium.

### 51.5.2.3 Properties of the Electrolyte

The electrolyte consists of a mixture of NaCl,  $\text{CaCl}_2$ , and  $\text{BaCl}_2$ . Some properties of these salts are listed in Table 51.1.

**Table 51.1:** Physical properties of salts used in the Downs cell.

| Property  | NaCl  | $\text{CaCl}_2$ | $\text{BaCl}_2$ |
|---|-------|-----------------|-----------------|
| Melting point, °C   | 58.45 | 110.99          | 208.27          |
| Density of molten salt at $m_p$ , $\text{g/cm}^3$                                 | 1.6   | 2.1             | 3.2             |
| Electrical conductivity of the molten salt at $m_p$ , $\Omega^{-1}\text{cm}^{-1}$ | 3.6   | 2.0             | 2.0             |

The melting point of the ternary eutectic of these salts is 450 °C. However, the eutectic mixture is not suitable as a working electrolyte since the  $\text{CaCl}_2$  content of ca. 50% would result in an unacceptably high proportion of calcium in the sodium product. A mixture of 28% NaCl, 25%  $\text{CaCl}_2$ , and 47%  $\text{BaCl}_2$  (51 mol% NaCl, 24 mol%  $\text{CaCl}_2$ , 25 mol%  $\text{BaCl}_2$ ) is suitable. This mixture melts at 570 °C, and the calcium content of the sodium produced is ca. 1%.

If the rate of sodium chloride addition varies during electrolysis, the NaCl content of the mixture and its melting point fluctuate, but the  $\text{BaCl}_2$ – $\text{CaCl}_2$  weight ratio remains practically constant at 1.88. For example, melting points of the mixture are 550 °C for 26% NaCl and 600 °C for 32% NaCl.

The current efficiency would be 100% if pure sodium were deposited at the cathode, and no back reaction of sodium with chlorine occurred to form sodium chloride. The diaphragm prevents sodium droplets formed at the cathodes from reacting with the chlorine bubbles formed at the anodes.

However, another possible mechanism for the back reaction, associated with the slight

solubility of sodium in the melt, causes the melt to become a partial electronic conductor [55]. The dissolved sodium dissociates into sodium ions and electrons [56]. The electrons and surrounding cations form color centers, called F-centers, that impart a bluish appearance to the melt.

If dissolved sodium is present in the cathode compartment, electrons migrate in the electric field from the cathode across the diaphragm where they react with sodium ions to form sodium. This sodium recombines with the gaseous chlorine present in the anode compartment, which decreases the current efficiency.

To remove dissolved metal (mainly sodium) from the electrolyte, two methods of regeneration have been proposed. In both of these, regeneration of the melt takes place outside the cell. The melt can be melted repeatedly and allowed to solidify, so that the dissolved metals coagulate and separate from the salt melt [57], or the dissolved metals can be oxidized by passing air through the salt melt [58].

Under some circumstances (e.g., during a plant shutdown), the sodium production rate of a cell may have to be reduced for a period of time without interrupting the ohmic resistance heating of the cell. To achieve this, 0.1–0.5% aluminum oxide can be added to the melt [59]. Solid bridges of aluminum form between the cathode and the diaphragm, and the latter starts functioning as the cathode. Recombination of sodium with chlorine is no longer prevented and the current efficiency is drastically decreased. Since the melting point of aluminum (660 °C) is above the operating temperature of the cell the aluminum bridges do not melt. To restore the current efficiency to its normal value, the bridges are broken by shaking the diaphragm or replacing it.

#### 51.5.2.4 Other Electrolytic Processes

Sodium can be deposited electrolytically on a molten lead or mercury cathode to form an alloy [31]. Using this principle, Ashcroft has

designed a double cell, in whose primary cell an amalgam is formed by electrolysis of aqueous NaCl with a mercury cathode. Alternatively, molten sodium chloride is electrolyzed with a molten lead cathode. The alkali-metal alloy is then transferred to the secondary cell where the molten salt electrolyte (*mp* ca. 200 °C) is  $\text{NaNH}_2$ , NaCN, or an NaOH–KOH mixture. In the secondary cell, the alloy is anodically decomposed into its constituents, whereby the alkali metal is deposited on the cathode and the alloying metal is returned to the primary cell. However, the Ashcroft process could not compete with other electrolytic processes.

In the Szechtman process, a sodium–lead alloy is produced by electrolysis of molten sodium chloride with a molten lead cathode. The sodium is then recovered from the alloy formed by distillation [31].

Sodium can be recovered by electrolysis of the amalgam produced in the chlor-alkali electrolysis process. Several electrolytic methods have been developed for recovering sodium from the amalgam, but they have not been used commercially (e.g., the Tekkosha process [10, vol. 17, p. 151]).

Reference [60] describes the use of a solid ceramic that conducts sodium ions (as used in the sodium-sulfur battery) as a divider for a two-compartment cell. This method allows low-melting sodium salts or salt mixtures to be used to produce sodium [1, vol. 21, p. 193; 60–64]. This type of cell should give current efficiencies approaching 100% with 30% lower energy consumption, as well as producing high-purity sodium. The process has, however, not been operated on a large scale [1].

## 51.6 Safety

If appropriate regulations and special safety precautions are observed, sodium can be handled safely in inert systems or even in the open air, provided its temperature is < 115 °C [11]. The possibility of leakage from pipework and vessels containing molten sodium must be guarded against, because spontaneous ignition

can occur at > 115 °C [65]. Effectively fighting sodium fires requires a detailed knowledge of the combustion properties of sodium [66]:

- In sodium fires in vessels in the open air, the temperature in the reaction zone is 900–1000 °C. Even in unfavorable conditions, the temperature of the sodium remains below its boiling point. Hence, high rates of combustion, such as those observed with boiling liquids, do not occur with sodium.
- For any equipment carrying molten sodium, a special system of containment must be provided that safely retains sodium escaping from a leak and effectively prevents contact with air so that a fire cannot develop.
- The preferred material for insulating sodium-carrying pipework and vessels is rock wool or slag wool with a low content of free silica. For higher temperature, ceramic fibers are suitable. Fibrous insulation made from molten materials is less hygroscopic than powdered or foamed porous material and is therefore preferable. The action of burning sodium on concrete has been studied in detail [67, 68].

The question of an optimum extinguishing agent has been discussed in the literature. The provision of inert-gas atmospheres such as nitrogen or argon in areas at risk from fire is generally too expensive. For pure sodium fires, which take place at the surface, a special expanded graphite is a very suitable fire-fighting material [69]. This powder floats on liquid sodium and thus prevents access of oxygen. Other powders, however, sink in the sodium and hence fail to provide a covering layer. The amount of such powder used on a vessel of molten sodium must therefore always be sufficient to absorb all the sodium and shield it against air [66]. To extinguish small spillages of sodium that have caught fire, powders specially developed and permitted for metal fires (Class D fires), as well as dry salt, dry sand, and anhydrous sodium carbonate, are suitable [11]. Water, foam, halons,  $\text{CO}_2$ , and fire-extinguishing powders of Classes A, B, and C must not be used under any circumstances [11].

Sodium burns to form sodium oxide ( $\text{Na}_2\text{O}$ ) and sodium peroxide ( $\text{Na}_2\text{O}_2$ ). With surface fires, 10–30% of the sodium forms an atmospheric aerosol with a typical particle size of 0.001–0.002 mm. They combine with atmospheric moisture within a few seconds to form sodium hydroxide. This is followed by reaction with carbon dioxide to form sodium carbonate or hydrogencarbonate, which takes about 3–5 min [70–72].

To clean equipment contaminated with sodium, the sodium-containing residues are first removed mechanically and then disposed of (e.g., by controlled combustion). The remaining sodium can then be converted into hydroxide by steam. The excess steam renders the reaction zone inert [11]. The removal of sodium by melting and cleaning out with steam and an alcohol water mixture (isopropanol with 5% water) is described in [73]. Small amounts of sodium in the laboratory can be converted to alkoxides, first with isopropanol, then with ethanol, and finally with methanol. Only when hydrogen evolution has ceased should the solution be treated with water. Very small amounts of sodium can be disposed of by storage under paraffin oil in an open beaker, which results in gradual conversion to the hydroxide.

## 51.7 Uses

**Sodium Compounds.** Some sodium compounds are important because of their nucleophilic properties.

Sodium hydride [74] is produced from sodium and hydrogen at 200–350 °C. Large quantities are reacted with trimethyl borate to form sodium borohydride

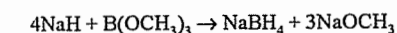

which is a very good hydrogenation and reducing agent. Its reducing power can be controlled by selection of the solvent and by adding ionic compounds. Sodium hydride reacts with the following compounds to give their sodium salts [103]: alcohols, phenols, thiols, amines, ketones, alkynes, and carboxylic acids.

Sodium amide [74], which is produced from sodium and ammonia, is used mainly to synthesize indigo by the Heumann-Pfleger reaction and to produce sodium azide for the explosives industry. In the Heumann-Pfleger indigo synthesis, sodium amide is used to cyclize phenylglycine, forming indoxyl in very high yield [12, 74]. The reaction is carried out in molten sodium amide at 180–200 °C.

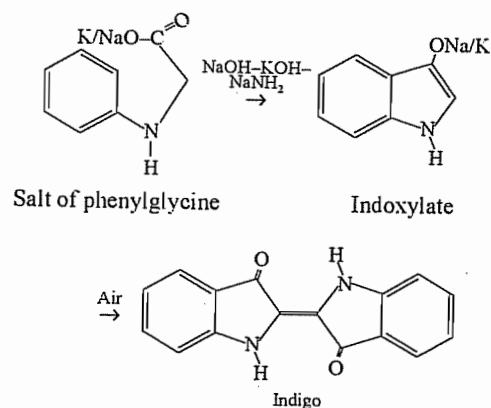

Sodium azide is synthesized by reacting molten sodium amide with dinitrogen oxide:

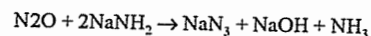

On an industrial scale, liquid ammonia is used as a solvent. In a variation of the method, sodium and ammonia are used without isolating  $\text{NaNH}_2$  [9]

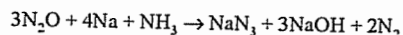

Sodium alkoxides [74] are used for *C*-, *N*-, and *O*-alkylation reactions (e.g., of malonic esters, acetoacetic esters, cyanoacetic esters, and benzyl nitrile) and in ring-closure reactions to form nitrogen-containing heterocycles. Alkoxides are used as synthetic building blocks in the Williamson ether synthesis.

**Organometallic Compounds.** The production of organometallic compounds is an important use of sodium. Organometallic compounds of group IV B metals can be prepared by a modified Wurtz synthesis [74].

Organotin compounds can be produced by the reaction



which, however, is used less often than other methods. Tributyltin oxide is an effective wood preservative:

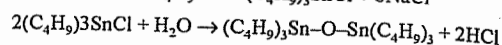
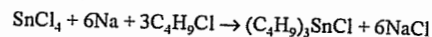

Tetraethyllead,  $\text{PbEt}_4$ , is produced by reacting a sodium-lead alloy with chloroethane. Use of the antiknock agents [75]  $\text{PbEt}_4$  and  $\text{PbMe}_4$  is being increasingly restricted as a result of environmental legislation.

**Synthesis of Vitamin A.** The preferred method for the production of vitamin A involves the Wittig reaction, i.e., the reaction of methylenetriphenylphosphorane with benzophenone to give triphenylphosphine oxide and 1,1-diphenylethylene [76]. Triphenylphosphine is produced from chlorobenzene, sodium, and phosphorus trichloride [76].

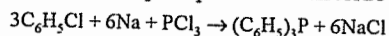

Since the expensive triphenylphosphine is irreversibly converted to triphenylphosphine oxide in the Wittig reaction, ways have been sought to reuse the latter. An economic process has been developed in which the phosphine oxide is reacted with phosgene to give the dichloride, which is coproportionated with phosphorus [76].

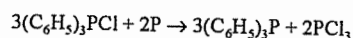
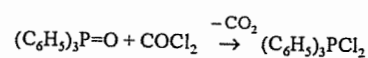

**Metallurgy.** Metals such as titanium, zirconium, tantalum, hafnium, and niobium can be produced in high purity by reacting their chlorides with sodium. Pure titanium was first prepared in 1887 by two Swedish chemists, using the reaction

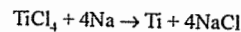

This method of preparation became known as the Hunter process. The reaction of sodium with titanium tetrachloride is usually carried out by placing the two reactants in an evacuated steel bomb and initiating the reaction by passing an electric current through a wire. Other methods of production are now available (e.g., a process involving direct electrolysis of titanium tetrachloride).

Small amounts of sodium are used in lead refining, for optimizing aluminum silicon melts and improving the properties of bronzes [11]. Sodium treatment [77] of Al-Si melts prevents anomalous crystallization, characterized by the precipitation of needle-like or lamellar silicon [78–80]. Sodium leads to supercooling processes [81, 82] that result in rounded eutectic silicon, normal fine eutectic solidification, and improved material properties, especially tensile properties [83].

**Sodium-Sulfur Batteries.** Rechargeable batteries with liquid sodium as the anode, sulfur-sodium polysulfide as the cathode, and sodium-doped aluminum oxide as the solid electrolyte are available for testing in the automobile industry [5, 84].

The two active materials, sodium and sodium polysulfide, are separated by a solid electrolyte of  $\beta$ -aluminum oxide, which conducts sodium ions. The operating temperature of the battery is 300–350 °C [85]. The most important component of a sodium-sulfur cell is the tube of solid electrolyte that separates the two molten electrodes. This material must be highly permeable to sodium ions and have a long lifetime to give a sodium-sulfur battery with a high power density and long working life [86].

**Sodium as a Heat-Transfer Medium.** The alkali metals, particularly sodium, were first used on a large scale as heat-transfer media by the nuclear energy industry. Today, liquid sodium is used worldwide as a coolant in fast breeder reactors. Power stations may contain several thousand tonnes of the metal. Both its nuclear properties and its very favorable thermal properties have led to the choice of sodium to cool fast breeder reactor cores, where the heat flux is high. Alkali metals are also used to a limited extent as heat-transfer media outside the nuclear industry [87]. In a solar energy plant in the Mojave Desert, California, sodium is used to store energy and transfer it from the collector to the steam generator [88].

## 51.8 Alloys

**Sodium-potassium alloys** [89] are used mainly in heat exchange systems, because of their good thermal conductivity and the wide temperature range over which they are liquid. The physical properties of two typical Na-K alloys are listed in Table 51.2. A review of physical properties and chemical reactions is given in [13]. Large-scale production is described in [5]. The ternary alloy, 12% Na, 47% K, and 41% Cs, has the lowest known melting point (–78 °C) of all metallic systems [9].

Table 51.2: Physical properties of Na-K alloys [8].

| Property  | Composition, % K |        |
|---|------------------|--------|
|   | 44               | 78     |
| Melting point, °C   | 19               | –12.67 |
| Boiling point, °C   | 825              | 784    |
| Density, kg/m <sup>3</sup> (100 °C)                             | 886              | 847    |
| Viscosity, mPa·s (250 °C)                                       | 0.316            | 0.279  |
| Heat capacity, kJkg <sup>–1</sup> K <sup>–1</sup> (200 °C)      | 1.096            | 1.045  |
| Thermal conductivity, Wm <sup>–1</sup> K <sup>–1</sup> (200 °C) | 26.36            | 25.10  |

**Sodium Amalgams.** Sodium and mercury form the following intermetallic compounds:  $\text{NaHg}_4$ ,  $\text{NaHg}_2$ ,  $\text{Na}_7\text{Hg}_8$ ,  $\text{NaHg}$ ,  $\text{Na}_3\text{Hg}_2$ ,  $\text{Na}_5\text{Hg}_2$ , and  $\text{Na}_3\text{Hg}$  [90, 91]. A liquid amalgam containing ca. 1% sodium is an intermediate product in chlor-alkali electrolysis and is used to produce sodium hydroxide solution. Amalgams with higher sodium content (1.25%) are viscous liquids. Still higher sodium contents result in silvery-white crystalline solids [10]. The physical properties, chemical reactions, and production of sodium amalgam are described in [13].

Many attempts have been made to utilize the reducing properties of sodium amalgam in chemical syntheses [92]. Sodium dithionite is produced on a large scale by the reduction of  $\text{SO}_2$  with sodium amalgam. Other uses of sodium amalgam include the production of sodium sulfide, reduction of salicylic acid to salicylaldehyde, and reduction of nitrobenzene to azobenzene. These reactions are no longer of industrial importance. The reaction of sodium amalgam with alcohols in a vessel



filled with graphite spheres to form alkoxides is used to a limited extent [92].

Sodium amalgam formation can be used to recover mercury from mercury-containing button cells. After treatment with molten sodium, the nonextractable solids are removed, and the amalgam is decomposed electrolytically into its constituents with a solid electrolyte made of sodium-ion-conducting  $\beta\text{-Al}_2\text{O}_3$  [93].

## 51.9 Packaging and Transport

### 51.9.1 Sodium Metal

Alkali metals are often marketed in shaped pieces of various sizes and weights. However, sodium is supplied to the customer mainly in the form of cast blocks produced by pouring the molten metal into containers and allowing it to cool and solidify. The shaped pieces are produced primarily by melting and casting the liquid metal. Alkali metals, especially sodium, are also pressed into variously shaped billets while in the solid state. The most serious disadvantage of these processes is the formation of impurities by reaction of the metal with air and atmospheric moisture. Also, the high pressure required for pressing the solid metal leads to wear. Pressing solid alkali metals is always a batch operation. The output of the machine is therefore limited, and the labor costs are high compared to a continuous process.

The production of alkali metal billets by continuous casting under pressure has also been described. In the presence of a lubricant the molten metal is forced by a pump through a die cooled to below the melting point of sodium [94].

In the extrusion molding process described in [95], molten metal is charged batchwise into the so-called feeder and, after cooling, until it is in a hot plastic state, is formed into an ingot, which is then extruded to form a billet by means of a plunger.

In the technique described in [96], two separate sets of machinery are used for extrusion

of the alkali metal. The molten metal is fed into a gear pump, which delivers liquid metal. In a cooler, which is separate from the pump, the liquid alkali metal is cooled below its melting point and pressed into a solid shape under pressure from the gear pump (ca. 15 MPa).

In a state-of-the-art process [97], liquid alkali metal is fed into a twin-screw extruder, which is cooled such that the temperature falls to slightly below the melting point of the metal just before the extrusion die. The alkali metal is thus solid but sufficiently ductile for extrusion. The extrusion pressure at the outlet is 3–5 MPa.

The alkali-metal billet produced can be cut by an automatic cutting device, sometimes under a protective gas, to produce lengths suitable for packing. Figure 51.6 shows a schematic of an extrusion plant for the production of alkali-metal billets [97].

After manufacture, sodium is in the molten state and can be filled immediately into freight containers. The following types are available:

- Rail tank cars with a capacity of up to 45 t sodium
- Road tank vehicles with a capacity of up to 20 t sodium
- Iso-containers with a capacity of up to 20 t sodium
- Special containers with a net capacity of up to 5 t sodium, and smaller packaging units in the form of drums of various types

Sodium is usually transported in the solid state for safety reasons and therefore must be remelted before it is emptied from the containers. This method of shipment allows the metal to be delivered in a very pure form. However, special handling equipment at the unloading site is required.

### 51.9.2 Transport Regulations

Sodium metal is a Class 4.3 hazardous material for all kinds of transport [98]. Detailed transport classifications read:

- Road and Rail (Europe), ADR/RID: Class 4.3, No. 11a

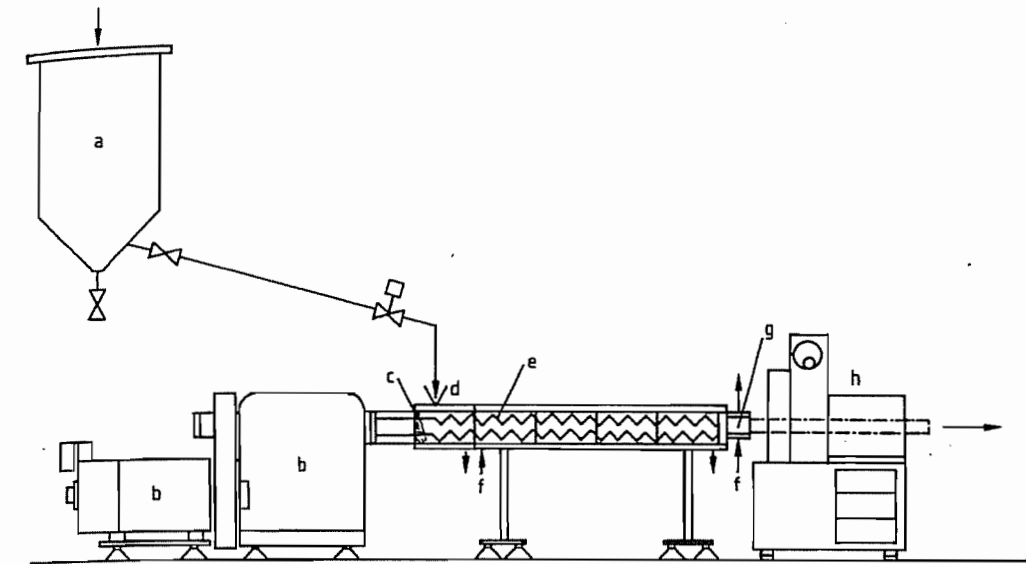

Figure 51.6: Schematic of an extrusion plant for the production of alkali-metal billets [97]: a) Sodium storage tank, heated; b) Drive; c) Sealing layer of sodium; d) Feeding nozzle; e) Twin-screw extruder; f) Heating and cooling jacket; g) Extrusion die; h) Cutting machine.

- Inland Waterways (Europe), ADNR and ADN: Class 4.3, No. 11a
- Sea Cargo (Worldwide), IMDG Code: Class 4.3, UN No. 1428, PG. I
- Air Cargo (Worldwide), ICAO-TI and IAT-ADGR: Class 4.3, UN No. 1428, PG. I

The European transport regulations were harmonized with the UN-recommendation-based regulations for sea and air transport of January 1, 1993. Thus sodium metal may be transported worldwide by using a unified packing system. However, different weight limits and packaging requirements are specified for various methods of transport.

### 51.9.3 Break-Bulk Packaging

For all kinds of transport UN-approved PG. I packaging has to be used. PG. I means the highest test standard for performance-oriented packaging. The packaging must have no venting device.

**Road and Rail Transport in Europe.** Sodium metal must be hermetically sealed, so that neither moisture nor any other substance can penetrate the packaging and come in con-

tact with the contents. The provision to cover the sodium with an inert gas or protective liquid is no longer required.

The following types of packaging are permitted: single packaging such as drums and cannisters with removable head (made of steel or plastic) with a maximum capacity of 450 L or a net weight of 400 kg, as well as combination packaging (such as glass containers of 5-kg capacity, plastic containers of 30-kg capacity, or metal containers of 40-kg capacity) inside outer packages such as wooden, cardboard, or metal boxes with a maximum permissible net weight of 400 kg.

**European Inland Waterways.** Packaging regulations for European inland waters are identical with those for road and rail transport.

**Sea Transport.** In contrast to land transport, a distinction is made between lumps and solid fused goods (i.e., those poured into the container in a molten state) in sea transport.

Lumps have to be packed in hermetically-sealed (vapor-tight closure) packaging and must be completely covered by a protective liquid (flash point > 50 °C) or covered with nitrogen. The following types of packaging are

permitted: Steel drums with removable head with a maximum net weight of 250 kg, or combination packaging such as glass bottles (max. 1 kg gross) packed in wooden boxes (max. 5 kg gross), metal boxes or cans (max. 15 kg net) packed in wooden boxes (max. 115 kg gross), or cardboard boxes (max. 40 kg gross).

Solid fused sodium must be packed in effectively closed (liquid-tight closure) drums with removable head with a maximum net weight of 250 kg.

**Air Transport.** Sodium metal may be transported only by cargo aircraft; transport by passenger aircraft is not permitted. The net weight per package must not exceed 50 kg. Special conditions and permitted types of packing are described in packing instruction No. 418 of the air transport regulations ICAO-TI/IATA-DGR<sup>12</sup>.

#### 51.9.4 Portable Tanks

Portable tanks include rail tank cars, road tank vehicles, and demountable tanks. Rail tank cars have a capacity up to ca. 45 t; tank containers and road tanker trucks, up to ca. 25 t.

Tanks for transporting sodium metal must be tested to a minimum pressure of 0.4 MPa. The temperature on the tank shell must not exceed 70 °C during transportation. Insulating material must be nonflammable. The atmosphere inside the tank must be inerted by an inert gas.

**Road and Rail Transport in Europe.** Although the transport of molten sodium metal is allowed, many producers allow the fused sodium to solidify the outer layer, so that escape of liquid sodium is prevented in case of leakage. Openings below the surface level of the material are permitted.

Portable tanks for sodium metal must undergo testing at eight-year intervals after the first certification, including testing of the condition of the inside and outside of the vessel and pressure testing with a liquid. In addition, a leakproofness test of the tank with its equip-

ment and a check of the satisfactory operation of the equipment must be carried out at least at four-year intervals.

**Transport by European Inland Waterways.** Regulations for inland waterways are identical with those for the road and rail transport of movable large containers.

**Sea Transport.** IMO tank type 1 containers with a minimum wall thickness of 6 mm and a minimum test pressure of 0.4 MPa must be used. IMO tank type 1 tanks have a capacity of > 450 L, with a maximum permitted operating pressure of 175 kPa or above. Road tank vehicles and rail tank cars used to transport sodium on seagoing vessels have to comply with the IMO tank type 1 provisions too. In contrast to the land transport regulations, the sea transport regulations do not permit openings below the surface level to the material, i.e., the tank must be equipped with top openings. For sea transport, the sodium metal must be in the solid state.

### 51.10 Quality Specifications and Analysis

Sodium is marketed with a purity of > 99%. Depending on the production method, standard-quality sodium can contain between 400 and 600 ppm of calcium [11]. Purification of sodium is described in [8].

Methods based on filtration and cooling depend on the low solubility of many elements in liquid sodium just above its melting point. Impurities remain in the filtration residue or settle out in solid form in cool traps.

The affinity of some of the impurities in sodium for oxygen is also utilized in purification processes since the oxides formed are easily removed from the sodium. For example, calcium is reacted with Na<sub>2</sub>O or Na<sub>2</sub>O<sub>2</sub> at 300–400 °C, and the calcium oxide formed is filtered off [5, 99].

The trace elements in sodium are listed in Table 51.3, with typical analysis figures and analytical methods [11]. Sodium can also be obtained in special grades [100].

**Table 51.3:** Trace impurities in sodium: Typical analysis figures and methods of determination [11].

| Element              | Concentration, ppm | Methods of determination |
|----------------------|--------------------|--------------------------|
| Aluminum             | 0.5                | AAS, Zeeman              |
| Arsenic              | < 1                | AAS, Zeeman              |
| Barium               | < 5                | AAS, Zeeman              |
| Boron                | < 1                | Photometric              |
| Calcium <sup>a</sup> | 450                | Titrimetric              |
|                      | 5                  | AAS                      |
| Carbon               | 2                  | Dissolve, filter, GC     |
|                      | 7                  | Vacuum distill, GC       |
| Chlorine             | 4                  | Nephelometry             |
| Chromium             | < 0.5              | AAS, Zeeman              |
| Cobalt               | < 0.5              | AAS, Zeeman              |
| Copper               | < 0.5              | AAS, Zeeman              |
| Iron                 | 4                  | AAS, Zeeman              |
| Lead                 | < 0.5              | AAS, Zeeman              |
| Lithium              | < 1                | AAS                      |
| Magnesium            | < 1                | AAS, Zeeman              |
| Nickel               | < 0.5              | AAS, Zeeman              |
| Oxygen <sup>b</sup>  | 7                  | Amalgam process, AAS     |
| Phosphorus           | < 0.5              | Photometric              |
| Potassium            | 70                 | AAS                      |
| Silicon              | < 1                | AAS, Zeeman              |
| Silver               | < 1                | AAS, Zeeman              |
| Strontium            | 5                  | AAS, Zeeman              |
| Sulfur               | < 4                | AAS                      |
| Tin                  | < 1                | AAS, Zeeman              |
| Zinc                 | 0.3                | AAS, Zeeman              |

<sup>a</sup> Specification: normal grade < 600 ppm, nuclear grade < 10 ppm.  
<sup>b</sup> Owing to the high affinity of sodium for atmospheric oxygen, moisture, and carbon dioxide (formation of oxides, hydroxide, and carbonate), the figures given apply only to sodium that has come in contact with dry inert gas atmospheres (O<sub>2</sub> < 1 ppm, H<sub>2</sub>O < 1 ppm) during filling, storage, and handling.

### 51.11 Health and Safety

Sodium can be handled safely without endangering the health of personnel concerned, provided appropriate precautions are taken to deal with possible hazards [101]:

- Spontaneous ignition of sodium in moist air at > 115 °C
- Severe caustic effects of the combustion products of sodium
- Fire explosion associated with uncontrolled chemical reaction between sodium and acid, water, aqueous solutions, alcohol

Sodium must always be stored, transported, and handled under dry and inert conditions. Direct contact with the skin must be prevented by wearing gloves and clothing made of

flame-resistant material. The eyes are protected by spectacles, goggles, or shields in all circumstances.

Information and advice about necessary technical, organizational, and personal protective measures can be obtained from company publications [11, 102] and leaflets available from chemical industrial trade associations [101]. Methods for safe working with sodium in the laboratory are described in detail in [8, 11].

### 51.12 Economic Aspects

Until recently, sodium was used mainly for the production of lead-containing antiknock agents for gasoline and for the production of titanium. However, the increasing use of lead-free gasoline and the manufacture of titanium by other processes have led to a drastic reduction in sodium capacity worldwide [103, 104]. In 1979, world sodium capacity, excluding the former Eastern-bloc states, was estimated at 250 000 t/a [10]. By 1986, this had decreased to 200 000 t/a [5]. In 1993 it is expected to be ca. 80 000 t/a. The most important sodium producers in the Western world, with their 1993 capacities are listed below:

|  |            |
|--|------------|
| Du Pont, Niagara Falls, United States            | 51 000 t/a |
| Associated Octel, Ellesmere Port, United Kingdom | 20 000 t/a |
| Métaux spéciaux, Pomblière, France               | 12 000 t/a |

### 51.13 Sodium Chloride

The history of mankind is also a history of salt [105–110]. Although it is not clear how man learnt of its effects and its savory properties, salt has been mentioned in literature for thousands of years.

In the Odyssey, HOMER wrote: "travel ... until you meet mortals who do not know the sea and who never eat food seasoned with salt." Elsewhere he refers to salt as "holy". CASSIODORUS said: "Gold can be dispensed with, but not salt." Other notable historical sources that refer to salt include PLUTARCH, PLINY, HERODOTUS, the Old and New Testaments, and ancient Chinese writings.

Before the industrial revolution in the 1800s, salt was used almost entirely as a food-stuff and as a preservative. Its importance led people of all cultures to strive to find ways of obtaining this important, life-sustaining substance. The coastal regions of the Earth were the favored areas for salt production. Possibly the oldest mine in the world was worked in ca. 1000 B.C. at Hallstatt, Austria which gave its name to the "Hallstatt Culture". In Germany, salt was probably first won in Schwäbisch Hall in ca. 500 B.C. The well-known salt deposit in Wieliczka, Poland was first mentioned in the 1100s. Wherever natural brine was available or early methods of brine production were practiced, a large number of salt works came into being between the 1100s and 1700s.

Salt was used universally, but was not everywhere available from natural sources, so that trading rapidly became important. The extent to which salt was used as an article of commerce is shown by the appearance of the famous salt roads in China, Africa, and Europe, and by the foundation of towns such as Salzburg, Salzach, Hall, Hallein, and Heilbronn (Celtic: *hal* = salt). Also, salt was used as currency (hence the word "salary") and as source of tax revenue. Ancient Rome had a salt tax, and salt monopolies were established in many countries and continue to exist in Austria and Switzerland. Starting in 1765, Prussia demanded an annual salt payment from its citizens, and in Germany a tax of DM 120/t was levied on all salt used in food. The total revenue from this in 1990 was DM  $47 \times 10^6$ . This tax was discontinued at the beginning of 1993, following the establishment of the European single market.

With the advent of the industrial revolution, the use of salt as a chemical raw material increased rapidly. Industrial salt production, whether by evaporation in salt works or from mined rock salt, continually increased in importance.

Another important process of recent decades is controlled solution mining.

Although salt is no longer the cause of war-like confrontations, it has certainly lost none of its fascination, whether as a life-giving con-

diment or as an indispensable, versatile raw material.

Many museums, e.g., the German Museum in Munich and the German Salt Museum, Lüneburg, have comprehensive exhibitions on the history of salt.

### 51.13.1 Properties [111]

Sodium chloride, NaCl, is a colorless salt with good solubility in water. Chemically pure NaCl crystallizes from aqueous solutions in well-formed cubes, which under the influence of surface tension often grow together into funnel-shaped, hollow, square-based pyramids. In the presence of impurities, octahedra or dodecahedra are sometimes formed. Crystallization from hydrochloric acid solution gives long, fibrous, needle-shaped crystals.

During crystallization, small amounts of water can be trapped in holes in the crystals. When this vaporizes on heating, it causes the crystals to explode with audible decrepitation. In salt from natural deposits, inclusions of gases such as methane, carbon dioxide, and hydrogen sulfide can occur.

In the crystal, the Na and Cl ions alternate. The ions of each type form a face-centered cubic lattice, in which each ion is surrounded octahedrally by six ions of the other type at a distance of  $a/2$  (lattice constant  $a = 0.56273$  nm). The modulus of elasticity perpendicular to the surface of the cube is 41 074 MPa. Under high pressure, slow flow takes place. Sodium chloride is highly transparent to light of wavelength between 200 nm (ultraviolet) and 15  $\mu$ m (infrared). Ionizing radiation causes lattice defects (color centers) which give the salt a blue color. On heating to ca. 250 °C, this color disappears.

Some important physical properties are listed below and in Tables 51.4–51.6.

|                                 |                                       |
|---------------------------------|---------------------------------------|
| Melting point                   | 801 °C                                |
| Boiling point                   | 1465 °C                               |
| Density at 25 °C                | 2.1615 g/cm <sup>3</sup>              |
| Mohs hardness                   | 2–2.5                                 |
| Brinell hardness                | 14 HB                                 |
| Dielectric constant             | 5.9                                   |
| Refractive index $n_D^{20}$     | 1.5443                                |
| Electrical resistivity at 20 °C | $4.6 \times 10^{16} \Omega \text{cm}$ |
| at 100 °C                       | $1.38 \times 10^{13}$                 |

|  |   |
|--|---|
| Thermal conductivity at 17 °C                    | 0.072 W cm <sup>-1</sup> K <sup>-1</sup>  |
| Linear coefficient of expansion                  | 40.5 $\mu\text{m/mK}$                     |
| Specific heat capacity at 25 °C                  | 850 J kg <sup>-1</sup> K <sup>-1</sup>    |
| Enthalpy of formation at 25 °C                   | -410.9 kJ/mol                             |
| Entropy at 25 °C                                 | 72.36 J mol <sup>-1</sup> K <sup>-1</sup> |
| Latent heat of fusion                            | 0.52 kJ/g                                 |
| Latent heat of evaporation                       | 2.91 kJ/g                                 |
| Viscosity of saturated aqueous solution          | 1.93 mPa·s                                |
| Density of molten NaCl at 801 °C                 | 1.549 g/cm <sup>3</sup>                   |
| Viscosity of molten NaCl at 850 °C               | 1.29 mPa·s                                |
| Surface tension of molten NaCl at 850 °C         | 110 mN/m                                  |
| Electrical conductivity of molten NaCl at 850 °C | 3.7 S/cm                                  |

Thermodynamic properties of aqueous solutions are given in [112].

In the system NaCl–H<sub>2</sub>O (Figure 51.7), only one hydrate, NaCl·2H<sub>2</sub>O, exists. It crystallizes as monoclinic, thin, bevelled platelets that decompose to solid sodium chloride and saturated brine at 0.15 °C. Below this temperature it is the stable solid phase. However, it crystallizes so slowly that, on rapid cooling, the phase diagram follows the broken curve in Figure 51.7. The metastable eutectic point reached is ca. 1.3 K below the true cryohydric point at -21.12 °C. Its property of depressing the freezing point of water enables sodium chloride to be used in freezing mixtures and as a deicing salt. The saturated aqueous solution boils at 108.7 °C.

Table 51.4: Solubility of NaCl in water.

| Temperature, °C | g NaCl/100 g H <sub>2</sub> O | NaCl, % | Density of solution, g/cm <sup>3</sup> | NaCl content of solution, g/L |
|-----------------|-------------------------------|---------|--|-------------------------------|
| 0               | 35.76                         | 26.34   | 1.2093                                 | 318.5                         |
| 20              | 35.92                         | 26.43   | 1.1999                                 | 317.1                         |
| 40              | 36.46                         | 26.71   | 1.1914                                 | 318.2                         |
| 60              | 37.16                         | 27.09   | 1.1830                                 | 320.5                         |
| 80              | 37.99                         | 27.53   | 1.1745                                 | 323.3                         |
| 100             | 39.12                         | 28.12   | 1.1660                                 | 327.9                         |
| 180             | 44.9                          | 30.99   |  |                               |

Table 51.5: Density of aqueous solutions of NaCl.

| NaCl, % | Density, g/cm <sup>3</sup> |         |         |        |        |
|---------|----------------------------|---------|---------|--------|--------|
|         | 0 °C                       | 20 °C   | 40 °C   | 60 °C  | 80 °C  |
| 4       | 1.03038                    | 1.02680 | 1.01977 | 1.0103 | 0.9988 |
| 8       | 1.06121                    | 1.05589 | 1.04798 | 1.0381 | 1.0264 |
| 12      | 1.09244                    | 1.08566 | 1.07699 | 1.0667 | 1.0549 |
| 16      | 1.12419                    | 1.11621 | 1.10688 | 1.0962 | 1.0842 |
| 20      | 1.15663                    | 1.14779 | 1.13774 | 1.1268 | 1.1146 |
| 24      | 1.18999                    | 1.18040 | 1.16971 | 1.1584 | 1.1463 |

Table 51.6: Vapor pressure of aqueous solutions of NaCl (in kPa).

| Temperature, °C | NaCl content |       |       |       |       |
|-----------------|--------------|-------|-------|-------|-------|
|                 | 5%           | 10%   | 15%   | 20%   | 25%   |
| 0               | 0.59         | 0.57  | 0.55  | 0.51  | 0.47  |
| 20              | 2.26         | 2.18  | 2.09  | 1.97  | 1.81  |
| 40              | 7.13         | 6.88  | 6.58  | 6.20  | 5.72  |
| 60              | 19.26        | 18.58 | 17.78 | 16.76 | 15.53 |
| 80              | 45.75        | 44.16 | 42.49 | 39.97 | 37.09 |
| 100             | 97.89        | 94.43 | 90.44 | 85.52 | 79.67 |

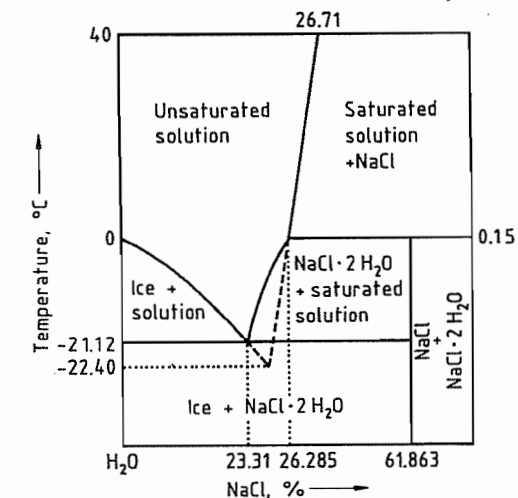

Figure 51.7: Phase diagram of H<sub>2</sub>O–NaCl system (schematic, not to scale).

Table 51.7: Solubility of sodium chloride in aqueous ammonia at 20 °C [113].

| [NH <sub>3</sub> ], g/L    | 15.38  | 30.06  | 62.56  | 92.97  |
|----------------------------|--------|--------|--------|--------|
| [NaCl], g/L                | 303.46 | 294.05 | 273.01 | 257.60 |
| $\rho$ , g/cm <sup>3</sup> | 1.186  | 1.175  | 1.147  | 1.124  |

Sodium chloride has good solubility in aqueous ammonia (Table 51.7). At low temperatures, fine white needles of composition NaCl·5NH<sub>3</sub> separate out. Addition compounds with urea, glucose, and sucrose also exist. Solubilities in pure methanol and pure ethanol at 25 °C are 1.31 and 0.065 g NaCl/100 g solvent, respectively. Sodium chloride is also soluble in glycerine, and dissolves in high pressure steam, the solubility being 0.1% at 17 MPa, and 0.6% at 19.5 MPa. Chemically pure sodium chloride is not hygroscopic, but if magnesium salts are present as an impurity it becomes so. Sodium chloride solutions are corrosive to base metals, and

therefore dilute solutions of NaCl are used in corrosion tests (e.g., DIN 50907). Solutions of pure NaCl are more corrosive than those that also contain salts of Mg or Ca [114]. Iron and steel are attacked only fairly slowly by pure NaCl solutions, but much more quickly when the solutions contain oxygen. Corrosion by NaCl solutions is accelerated by the presence of local electrolytic cells [115]. Mixtures of organic acids with sodium chloride, (e.g., in perspiration) are highly corrosive [116].

### 51.13.2 Formation and Occurrence of Salt Deposits [117]

When rocks are chemically weathered, salts are dissolved, carried into natural running waters, and collect in the oceans and inland lakes and seas. Where evaporation is predominant, the salts become concentrated until the solutions become supersaturated and crystallization occurs.

The proportion of sodium chloride in the salts of seawater is ca. 78%. Although the oceans contain the largest quantity of dissolved salts, the majority of salt is bound in the form of solid deposits. In Germany alone, the quantity is estimated to be ca. 100 000 km<sup>3</sup>.

The chemical-sedimentary genesis of salt deposits has been accepted ever since OCHSENIUS (1877) proposed his bar theory. Inspired by the contemporary example of the Kara-Bugaz bay (Caspian Sea), he suggested that bodies of seawater became almost completely isolated from the open sea by bars. Then, due to the evaporation that took place in arid climatic regions, the seawater became concentrated. The sparingly soluble carbonates and sulfates were the first to crystallize, followed by the more soluble chlorides.

In the case of the most important European salt deposit, the Zechstein Formation, communication with the North Sea has been proved by fossil finds, thus demonstrating the marine origin of the Zechstein salts, which extend over ca. 500 000 km<sup>2</sup> from England to Central Poland, and from Denmark to Thuringia/Hessen (Germany). The bar theory can satisfactorily

account for even the 800–1000 m thickness of the Zechstein salt deposit, and is valid even today, in modified form, for marine salt deposits. A depth of 100 m seawater produces a salt layer only 1.5 m thick on complete evaporation.

It is now believed that, for the European Zechstein salt deposit, the salt lakes were connected to the ocean by an extended saturation shelf lake where considerable amounts of CaSO<sub>4</sub> were deposited. The minor and major salt lakes were filled with salts during four largely identical deposition cycles, each having the sequence clay, calcium–magnesium carbonates and calcium sulfate, sodium and potassium chlorides, and ending with a recessive transition [sodium chloride, calcium sulfate (anhydrite), and clay] to the next cycle. The concentrations of the various soluble salts reached saturation successively as the seawater became gradually more concentrated, so forming the geographical sequence of salts. This explains why the composition does not correspond to that of normal seawater at any point in the salt profile, why all the types of salt are not deposited everywhere, why salts of differing solubilities are precipitated simultaneously at different saturation regions, and why the chlorides of potassium and magnesium are deposited only at the centers of the lakes.

The intermediate layers of clay sediments in each cycle are the result of influxes of fresh seawater. Eolian (airborne) transportation of clay minerals into the salt basin can also occur.

The depths of the brine in the deposition basins have been calculated from the bromine contents for each phase of deposition. The results obtained were: first cycle (Werra region) 330 m, second cycle in the Staßfurt region 860 m, and third cycle in the Leine region 95 m. In some cases the salt basin dried out during the third cycle. Sediments of younger formations covered and protected the Zechstein salts from dissolution.

In the North West German depression zone, a layer of overlying rock up to 5 km thick was formed. The pressure due to this denser rock, together with the interior heat of the Earth,

caused metamorphosis of the salt, which became plastic and migrated. It accumulated in zones of deformation and ascended, forming salt domes (diapirs) which sometimes extended as far as the earth's surface. These were slowly dissolved by groundwater, leading to the formation of very flat secondary intermediate layers next to the overlying rock.

The upward movement of the salt during the formation of salt domes deformed the salt layers into folds, with predominantly steeply inclined strata. Under the thinner overlying rocks at the edge regions, the flat deposits remained undisturbed. Marine rock salt deposits occur in most geological formations.

### 51.13.3 Production

#### 51.13.3.1 Mining of Rock Salt

Rock salt has been mined in Europe for 3000 years. A salt deposit near ground level in the Eastern Alps was developed by tunnelling and worked by excavation around 1000 B.C.

Salt-bearing regions are revealed by the presence of surface springs of saline water, and these were the areas where the possibility of mining was always investigated by sinking shafts. The main precondition for success is the presence of dry overlying rock, and it was this circumstance that enabled the first German salt mine to be opened in 1825 near Schwäbisch Hall. In other parts of Europe, salt was mined long before this, e.g., in Poland before 1000 A. D., and in England since the 1600s.

Total world production of solid salt by conventional mining and brine by solution mining is ca.  $190 \times 10^6$  t. Annual production of salt in West Germany in 1989 was ca.  $13 \times 10^6$  t.

The purity of the salt mined from rock salt deposits is between 90 and 99% NaCl, and sometimes higher. The other minerals present in the rock salt are mainly clay and anhydrite, often intimately intergrown.

Rock salt and potassium chloride have the same marine origin, often occurring together in a single deposit, and have essentially the same mechanical strength properties. Hence,

the development and mining of rock salt deposits is similar to that of potash mineral deposits.

**Mine Shafts.** Access from the surface to the salt deposit is usually by vertical shafts 5 m in diameter. There must be at least two shafts, so that in case of damage to one of them, the underground workforce has an emergency route to the surface.

To sink the shaft, the rock is broken up by drilling and explosives. The rock debris is loaded into skips by grabs, and taken to the surface. In most cases, the upper layers of the overlying rock are water-bearing, and sometimes consist of unstable loose rock and moving sand capable of exerting pressure. Therefore, before sinking the shaft, these strata must be solidified and stabilized. This can be achieved by freezing via holes drilled around the area where the shaft is to be sunk. The freezing equipment must be kept in place for the duration of the sinking of the shaft.

Another method of preventing the movement of water in the overlying strata and immobilizing loose rocks is the injection of cement, synthetic resins, or other hardening materials via boreholes. This technique is also suitable for sealing the mine shaft against the ingress of water and for stabilizing the rock at the bottom of the shaft.

As rock salt is a water-soluble mineral, it is especially important to ensure that the lining of the shaft is watertight when it is sunk through water-bearing strata. In older shafts, the sealing system consists of ring-shaped sections of cast iron or steel bolted together. Newer shafts have a watertight lining consisting of a welded sheet-steel cylinder, an inner hollow cylinder of reinforced concrete, and an outer asphalt-filled ring.

Material is hoisted up the shaft in 20 t skips at rates of up to 1000 t/h. These travel between wooden or steel guide rails, or in a few cases between tensioned guide cables.

If the salt deposit appears as an outcrop, or is at low depth (< 100 m), the salt can be extracted by drift mining (tunnelling) or by means of an inclined shaft. In these cases, the

salt can be transported to the surface with conveyor belts.

**Mining Methods.** As with any mining operation, the method of extracting salt depends on the thickness and spatial formation of the deposit.

A characteristic feature of salt mining is that the haulage and ventilation tunnels servicing the excavation chambers are driven through rock salt, whereas in other types of mine they are often coated in the adjacent rock. In salt mining this is generally not necessary, as the deposits are usually thicker. Furthermore, drilling and tunnelling into the adjacent rock should be avoided as far as possible to prevent ingress of water or gas from these strata into the mine.

**Mining in Level Deposits.** In most salt mines, a systematic extraction procedure is possible due to the uniformity of the deposit over large areas.

In salt deposits with horizontal or gently inclined seams, the standard method is room and pillar mining. In this method, the extraction process produces large chambers with rectangular cross sections of ca. 50–400 m<sup>2</sup> and lengths of up to 500 m. The parallel extraction chambers are separated from each other by rock salt pillars left behind during mining. These pillars must be of such dimensions that they can carry the weight of the overlying rock. Generally, additional support is not required, and the ground above is protected against subsidence.

The pressure exerted by the overlying rock increases with depth, so that the salt pillars must be wider. For example, in a salt mine at a depth of 200 m, the pillars are 15 m wide and the chambers 15 m; at a depth of 500 m, the pillars are 30 m wide and the chambers 20 m; and at a depth of ca. 700 m, the pillars are 50 m wide, and chambers 22 m. The salt pillars result in a ca. 40–70% loss of product, depending on their dimensions.

The salt extraction process starts with the construction of a central haulage tunnel. At right angles to this, tunnels leading to the working faces are driven. The tunnels are de-

veloped upward or downward to form chambers if the deposit is so thick that it extends above or below them. The salt pillars produced by this mining technique are usually not cut through.

If the deposits have a workable thickness of < 10 m, the pillar and chamber method with long pillars is often changed to one with short, square pillars (room and pillar system). Here, the transverse tunnels usually have the same height and width as the long ones.

Fresh air is provided by an inlet ventilation road above the haulage tunnel. The used air is removed through return air galleries and by the main ventilating fan, which is usually underground, and blown through the exhaust shaft to the surface.

The mining of the salt during the construction of the tunnels and in the extraction chambers is by drilling and the use of explosives. Other possible methods, such as cutting the salt by part-face heading or full-section cutting machines, are used where there are special restrictions, e.g., where the winning process must be vibration free.

Various drilling and blasting processes are used. In the undercutting method, the working face is undercut to a distance of 4–5 m. The cut, 15–20 cm wide, is produced by a machine resembling a chain saw. An electro-hydraulic mobile drilling machine drills 35–38 mm diameter holes for the explosive. In another process, a wide hole up to 7 m in length and 0.45 m in diameter is drilled into the middle of the working face to provide an initial extension space for the salt at the moment of explosion, a function that is performed in the undercutting process by the undercut.

The extraction chambers are created by widening the access tunnels. If these are driven through the lower part of the deposit, this is performed by the use of explosives in long inclined boreholes directed upwards. If the tunnel runs through the upper part of the deposit, the salt is extracted from the floor, i.e., by drilling long holes downwards into the salt.

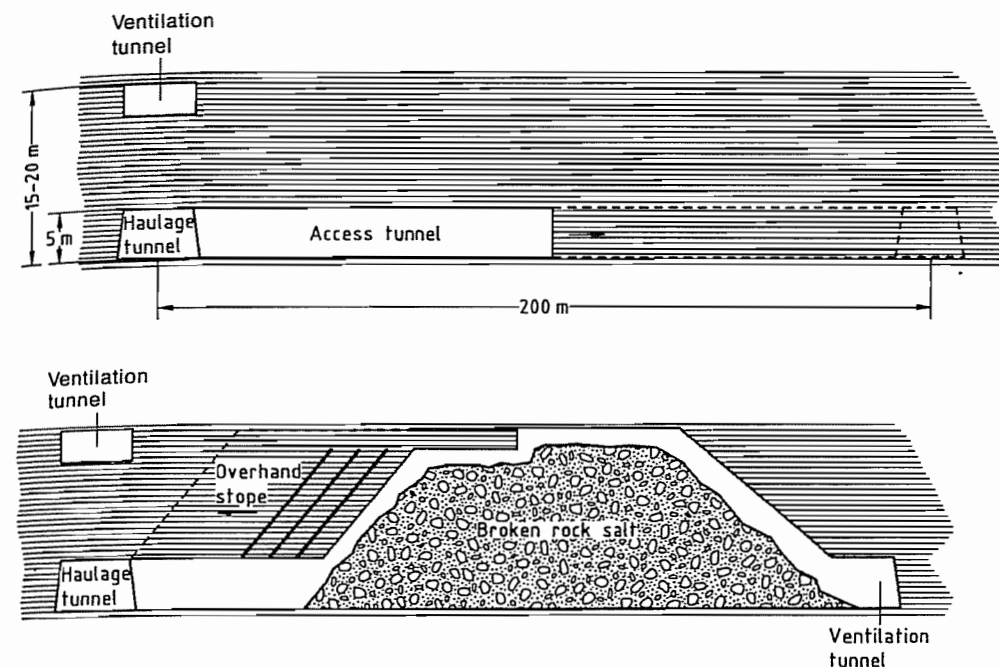

Figure 51.8: Vertical section through a South German salt mine.

Figure 51.8 shows a vertical section through a South German mine where the rock salt deposit is 20 m thick and 200 m deep. The haulage and working roads are located in the lower part of the deposit, and the main ventilation road in the upper part. In the main extraction phase, the salt that has been broken up by explosives is left lying in the space created, and the final position of the roof of the chamber is created by blasting, working from the top of the heap of loose salt. After scaling the roof can then be collected without the danger of roof falls.

The most commonly used explosive is ANFO (ammonium nitrate fuel oil mixture) in the form of loose prills. It is charged pneumatically into the boreholes.

Due to the strength of the salt rock, it is possible in most mines to keep the mined space open without supports. At great depths, where the pressure is high, or where breakup of the deposit leads to danger to the miners from roof falls of salt, rock bolts are used.

**Mining Steeply Inclined Deposits.** Steep vertical rock salt deposits are generally mined by the stepped face method, as used, for example, in North German mines at depths of 400–850 m, with working levels at vertical intervals of 100–250 m and intermediate sublevels at intervals of 15–20 m. Between the sublevels, there are working faces which are drilled and blasted, beginning with the lowest, using long boreholes. In one mine, the openings produced are 20 m wide, 42 m high, and 100 m long, and, in another, 20 m wide, 100 m high, and 60 m long.

To maintain stability of the rock, salt masses must also be left behind using the grid wall system, the vertical pillars being 10–30 m thick, and the horizontal pillars between the sublevels, 8 m thick.

**Loading and Haulage.** To load the mined material after blasting and to transport it to the first crusher, diesel-powered front loaders with bucket capacities of up to 18 t are used (LHD: Load, Haul, Dump System). For economic reasons, there should be a straight road

between loading and discharging points not longer than ca. 300 m. For longer distances, the interrupted system is more economic, with special loading equipment and dumper trucks of up to 50 t capacity.

After crushing the salt to < 300 mm using equipment near to the working face, it is transported by band conveyors to the hoisting shaft.

In mines where the salt has a purity of > 99% NaCl, the salt can be marketed directly after grain-size classification.

Where the natural purity is lower (e.g., 94% NaCl in South German mines), impact mills are used in the first processing stage. As rock salt is more brittle than the clay and anhydrite inclusions, it is more readily size reduced. A screening operation follows, separating the two size fractions, which increases the NaCl content by 2–3% compared to the crude salt. Further purification of the salt to > 99% NaCl for industrial use is carried out in heavy media hydrocyclones.

**Utilization of the Chambers.** Salt mining is mainly carried out without back-filling, i.e., the chambers produced during mining need not be backfilled with other material to support the roof of the mine and increase the load-bearing capacity of the salt pillars.

Where processing of the rock salts produces residues that must be disposed of, these are usually dumped in the empty chambers.

Hence salt mines do not produce heaps of tailings at ground level.

In some cases, empty chambers are utilized for disposing of waste materials, e.g., wastes from combustion processes and the chemical industry.

### 51.13.3.2 Production of Crude Brine by Mining Methods

The principle of all mining methods for the production of crude brine (NaCl solution) is the use of "solution mining".

The rock salt, which may be present in a pure state (e.g., geologically undisturbed crystalline salt deposits) or in a mixed mineral in finely divided form (e.g., in alpine salt deposits), is dissolved by the action of fresh water on the rock formation and converted to a concentrated salt solution (brine with an NaCl content of 312 g/L or 27%).

In all processes, the brine is produced in underground excavations made by conventional mining or solution mining [118–124]. The extraction processes result in formation of chambers [125]. Between the chambers in which the brine is produced and extracted, pillars of considerable size are left behind to maintain stability of the rock [126, 127]. Figure 51.9 gives a survey of brine mining methods.

Mining of brine is no longer widely used. It is employed in alpine salt deposits and in a few rock salt mines. The most widely used and most economic process today is solution mining [118, 119]. In a few cases, subsurface solution mining is also carried out at depths of 100–140 m [128, 129].

*Water flushing* (intermittent or continuous dissolution in chambers) is the extraction process usually used in the alpine salt deposits in West Germany and Austria [118, 119, 122–124]. Tunnels, shafts, and chambers are usually first produced by mining techniques. A single worked stratum is divided into separate districts of a given size in which several extraction chambers are set up. A block of definite dimensions (length, breadth, and height) is allocated to each chamber based on a predetermined degree of extraction. The block encompasses a space of irregular configuration produced by the extraction process and the pillars left between the extracted spaces, which are also of irregular shape. An initial space is first created, which is a funnel-shaped (Germany), or circular chamber (Austria). A shaft or tunnel is first driven from the main tunnel or a transverse tunnel to the center of the intended block at the bottom of the worked strata. A shaft is then sunk by mining techniques from which the initial chamber of a specific size is created at the lowest point by drilling and explosive methods (Austria). In Berchtesgaden, Germany, the initial space (Figure 51.10) required for excavation is created by drilling and water-injection processes. An important feature of this process [124, 126] is that the initial space is funnel shaped, and is generated by controlled dissolution, starting from a wide borehole, so that the insoluble components of the deposit can be raised by airlifting equipment and removed by a hydraulic pump as a solid-brine mixture. The production of the initial space is usually divided into the following stages (Figure 51.10): sinking a borehole for examination of the deposit in the region to be excavated, vertical development by sinking a wide borehole, further widening of the borehole by controlled dissolution, forming a funnel-shaped space at a

depth extending from 100 to 125 m. During this phase, the space normally attains a volume of 3000–5000 m<sup>3</sup>, depending on the quality of the deposit, with a height of 4–6 m and a diameter of 30–32 m. The creation of the initial space completes the preparation for the extraction process. The space is next extended further, conditions now having been established for continuous, high yield, cost effective brine production. The initial space (chamber) is slowly filled with fresh water, which dissolves salt from the side walls and roof. The insoluble components, such as clay, anhydrite, and polyhalite sink to the floor of the chamber. Fresh water is continuously added, raising the liquid level, so that water remains continuously in contact with the roof of the chamber until the water in the chamber is completely saturated. The dwell time depends on the salt content of the rock, the size of the chamber, the ease of dissolution of the salt, and the surface area of the chamber roof, and is usually between 10 and 30 days. After complete saturation has been attained (312 g/L), the brine is removed either by pumping out of the excavated space (if working below the tunnel level), or by draining off to the level below. The space is then refilled with fresh water. This procedure (filling, saturation, emptying), is known as intermittent water flushing, and is repeated until the chamber roof area has reached ca. 3000–3200 m<sup>2</sup>. The chamber is then ready for continuous brine production by the continuous water flushing process. The water flows at a rate appropriate for the parameters of the deposit, with simultaneous removal of concentrated brine by draining or pumping. The brine production is now almost invariably carried out below the main haulage level (Germany and Austria), i.e., working upwards from the bottom. Each day, 1–1.5 cm rock salt is dissolved from the surface of the roof of the chamber. The chambers take on a funnel-shaped to cylindrical configuration (Figure 51.10). Chamber heights in Austria [123, 128, 129] are 20–30 m (normal working) or 50–80 m (deep working), depending on the diameter. In Berchtesgaden, Germany, the exploitable height of the chamber is

Production of brine by mining methods

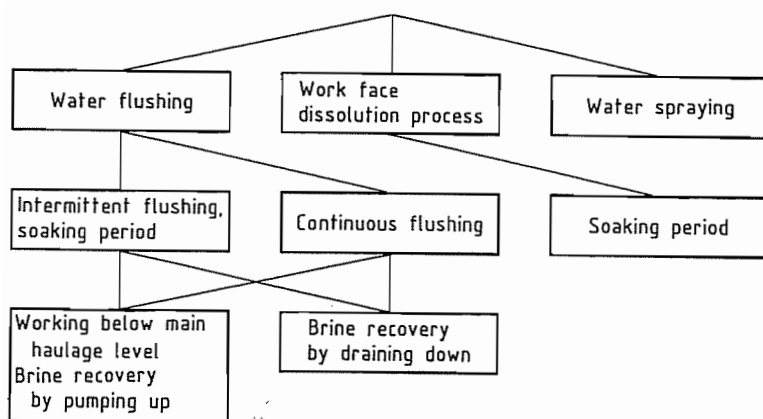
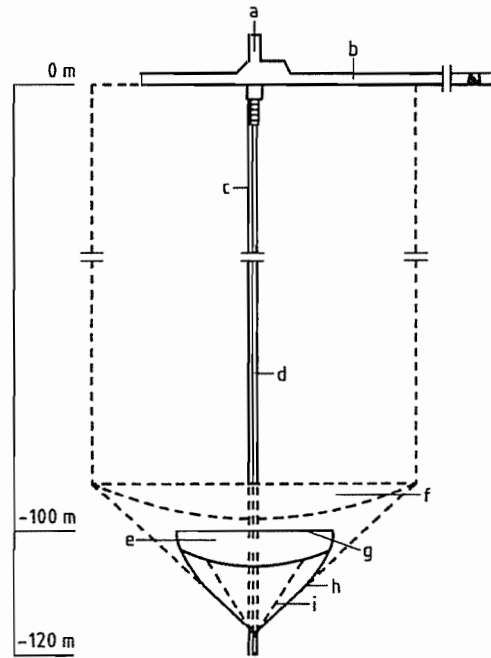

Figure 51.9: Classification of brine mining methods.

100 m. The initial space is created in the region between 100 m and 125 m below the level of the tunnel.

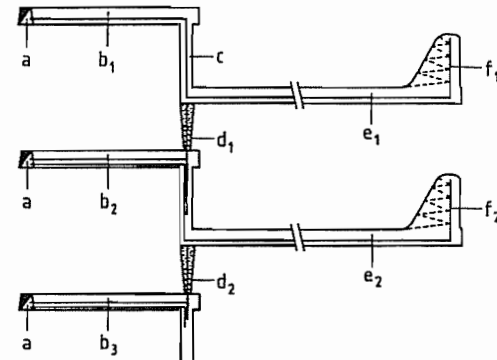

**Figure 51.10:** Production of the initial extraction chamber by drilling and water flushing, and brine production operating below the main tunnel (Salzbergwerk Berchtesgaden, Germany): a) Drilling chamber; b) Main tunnel; c) Borehole (76 mm); d) Wide borehole (670 mm); e) Initial extraction space; f) Developed extraction space; g) Chamber roof; h) Angle of boundary; i) Angle of repose of solid residues.

To calculate the efficiency of extraction of the deposit, the salt content of the rock and the size of the rock mass assigned to the particular operation point (cavern), including the horizontal safety pillars, must be taken into account. In Berchtesgaden, Germany, when the size of the horizontal and vertical pillars, the average salt content of alpine deposits (50%), and the usable height of the chamber (100 m) are taken into account, the total quantity of brine available per chamber is  $1.1 \times 10^6 \text{ m}^3$ . This corresponds to an extraction efficiency of ca. 12% [124, 126]. In Austrian salt extraction operations, the following total available quantities of brine have been quoted, depending on the type of extraction chamber [128] and

[129]: 200 000–400 000  $\text{m}^3$  for normal operations, and 700 000–1 000 000  $\text{m}^3$  for deep operations.

The *work face dissolution process*, in which dissolution is carried out in chamber-like tunnel sections, is similar in principle to the intermittent water flushing process, and is also not widely used. In some mining operations in Germany and Poland [119, 121] it is still operated alongside other brine production processes (e.g., solution mining using boreholes drilled from the surface).



**Figure 51.11:** Production of brine work-face dissolution: a) Access tunnels; b<sub>1</sub>–b<sub>3</sub>) Transverse tunnels for work faces 1–3; c) Borehole widened to make a shaft; d) Brine removal; e) Transverse tunnels; f<sub>1</sub>, f<sub>2</sub>) Spraying equipment.

To obtain the brine, transverse tunnels are driven one above the other on both sides of the main tunnel (Figure 51.11). The transverse tunnels are linked together at their ends by a borehole. Passing from one tunnel to the next, the borehole is widened to a shaft of 1 m diameter and provided with an outlet to the lower tunnels. About 10 m below each tunnel, a tunnel for brine production is driven from the widened borehole, a work face is produced by cutting upwards at the end, and spraying equipment is installed at that point. This creates a cut which moves backwards at a fixed height until it meets the widened borehole. After the initial work has been finished, the working is filled with water or unsaturated brine. The water or brine remains in the working until saturation is reached. The concentrated brine is then removed via the lower work face. In contrast to the water flushing

process described above, the salt is only removed from the work faces until the planned chamber width is produced.

The production of brine by means of water jets is only used to a small extent, being employed in a few cases to solve special problems, e.g., to speed up excavation during intermittent water injection at the development stage, or to regulate the configuration of the chamber during the water flushing process in large chambers.

### 51.13.3.3 Controlled Solution Mining

Controlled solution mining is the modern economical method of extracting rock salt from underground deposits, and contrasts with conventional mining (see Section 51.13.3.1). However, for this method certain preconditions must be fulfilled, especially with regard to the geology of the deposit (type, formation, and depth of the salt). Economic operation of the solution mining process requires that the deposit—whether a diapir (salt dome) or a flat stratum of salt—should fulfill the following geological conditions:

- Adequate thickness and extent of the salt deposit
- High purity of the rock salt without inclusions of potassium chloride
- Largely undisturbed stratification at medium depth

In addition, an adequate supply of water must be available.

### Drilling and Construction of the Borehole

The drilling and completion of the trial boring and the design and installation of the brine wells (also known as the cavern wells) closely resemble those of petroleum and natural gas wells. The method of operation and the geological conditions determine the size, type, and position of the casing that protects the walls of the borehole against the effects of permeable strata, and prevents solid material

from the rock from falling into the borehole. A standard pattern for the casing diameters in a cavern well (see Figure 51.12) is as follows:

1. 0–15 m: 24.5 inch pipe
2. 0–300 m: 16 inch pipe
3. 0–20 m (max.) beyond the projected roof of the cavern in the deposit: 11.75 inch pipe

The casings described in (2) and (3) above are cemented up to ground level.

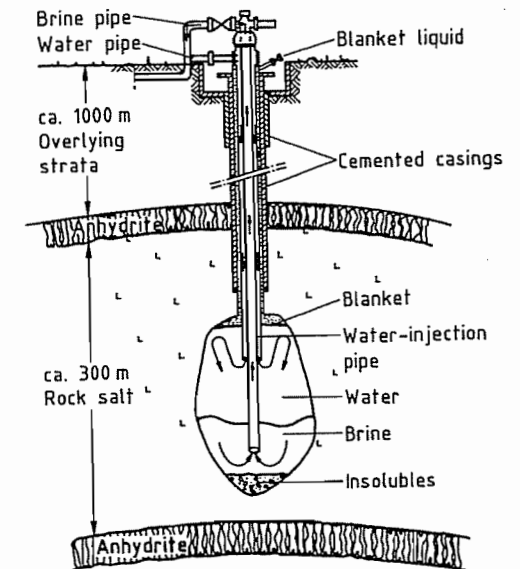

**Figure 51.12:** Method of brine production.

Geophysical borehole measurements and tests on the cores obtained during sinking of the borehole not only give information about mineralogical composition, but also yield physical data about the overlying rock and the salt deposit. The most important characteristics of the overlying rock are its thickness and strength. Also, to enable the dimensions of the cavern and the proposed extraction process to be decided upon, the strength and thickness of the salt deposit and the solubilities of its component parts must be known.

The outer casing must be installed and cemented with special care, and each individual joint as well as the whole casing must be tested for tightness. After this, the well is completed by inserting two concentric pipes (of di-

iameter between 8.625 and 5.5 inches), the final preparative work being the assembly of the well head and making all the pipe connections (Figure 51.12).

### The Process of Solution Mining

As shown in Figure 51.12, fresh water is pumped into the borehole through the annular space between the two inner pipes. The water dissolves salt from the walls of the cavern. The solution sinks as its salt content increases, and the saturated brine formed then rises to the surface in the central pipe due to the applied pressure.

Dissolution of salt from the roof is prevented by injecting a protective liquid or gas blanket through the annular space between the outer casing and the pipe carrying the fresh water. This blanket forms a layer above the water due to its lower density, so protecting the roof. Insoluble materials collect at the bottom of the cavern.

The desired cavern shape is produced by stepwise adjustments to the depth of the water-injection pipe and the level of the blanket [130–133].

The extraction process is controlled by continuously measuring the salt content of the brine, the blanket pressure, and the quantity of brine extracted. The cavern space produced is calculated from these data by computer, and the spatial extent of the cavern is continuously determined by echometric surveying. The actual cavern produced can then be continuously compared with the planned cavern.

### Planning of the Extraction Process

The safety of caverns can be ensured if pillars of adequate width are left between neighboring caverns and if there is a thick enough mass of solid salt at the top of each cavern. The width of the pillar and the thickness of the roof depend on the planned cavern dimensions, the cavern shape, and, in particular, on the mechanical properties of the salt deposit. The latter have been investigated in detail [133–139].

Furthermore, correlations and formulas have been derived that enable the forces produced in the rock to be calculated from the size and shape of the cavern, the interior pressure produced by the solution mining process or subsequent use for storage purposes, the depth and thickness of the overlying rock, and the mechanical properties of the surrounding rock formations. The decrease in the volume of large caverns (convergence) caused by elastoplastic properties of the rock salt are determined from formulas, confirmed by data from practical experience [134–143].

Irrespective of the widths of the pillars calculated with these equations, the wells in a brine field should be arranged in a hexagonal pattern (Figure 51.13), which gives optimum utilization of the available area.

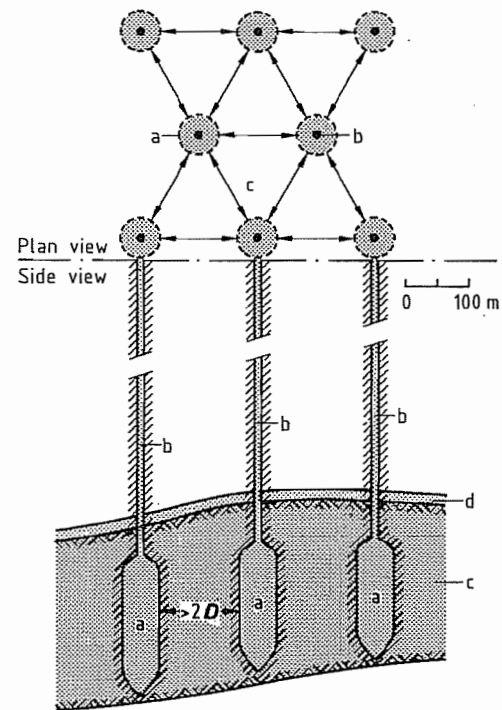

Figure 51.13: Hexagonal arrangement of caverns in a brine field with a level salt deposit: a) Cavern (diameter  $D = 60\text{--}100$  m); b) Borehole; c) Pillar of stable rock salt (thickness of pillar:  $2D$ ); d) Upper layer of anhydrite.

The distance between the brine wells is the sum of pillar width, the maximum cavern diameter, and a safety factor to allow for devia-

tion of the borehole from the vertical. If a borehole must be relocated due to the situation at ground level, the hexagonal arrangement below ground can be maintained by adjusting the drilling direction (Figure 51.14).

### Other Systems

Individual boreholes for extracting brine can generally only be operated economically in thick salt deposits or salt domes. However, thin salt deposits can also be exploited economically in some cases. Here, two or three boreholes are linked together by injecting water to dissolve the salt and to fracture it by hydraulic action [132, 144, 145]. Fresh water enters via the first borehole, and the brine is collected from the second or last borehole. Here also, dissolution of the roof is prevented by a blanketing medium. The floor is dissolved first, then the roof. With thin seams of salt, the strength and impermeability of the overlying strata are very important.

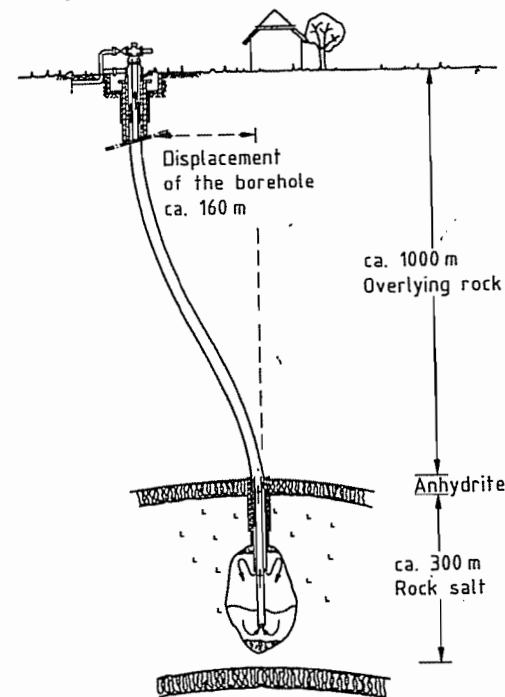

Figure 51.14: Directional drilling in the production of a cavern.

Control of this method of solution mining is more difficult than with individual brine wells. The stability of the cavern spaces cannot be guaranteed, as there is a risk of uncontrolled dissolution processes. Thus, this method of solution mining is only used in countries with few salt deposits where there are sparsely populated areas above thin salt strata.

### Equipment

The equipment requirements normally consist of

- Equipment for supplying water, sometimes including a pipeline
- A pumping station with a distribution system delivering water to the individual solution mining operations
- A pipeline for transporting the brine to the consumers
- A central system for supervising and controlling the entire processing equipment

The water is injected by high-pressure centrifugal pumps at a pressure determined by the difference in the densities of the two media (water and brine) and the friction losses in the pipes. The salt at the working face dissolves and passes through the central pipe as saturated brine to the well head and into the piping system. The low residual brine pressure at this point is sufficient to deliver it to the pumping station, where delivery pumps force the brine into the pipeline that takes it to the consumer industries.

### Storage Caverns

The caverns remaining after extraction of the sodium chloride can be used for storage of mineral oil, mineral oil products, and gases such as natural gas and ethylene.

Emergency reserves of mineral oil or mineral oil products can be injected through a pipeline into the brine-filled caverns by a high-pressure pump. In place of the two concentric pipes used in solution mining, a brine removal pipe is suspended in the cavern with its open end just above the sump region. The mineral oil is forced into the annular space be-



tween the outer pipe and the brine removal pipe and displaces the brine, which rises through the brine removal pipe to the surface and is fed into the brine network, and thence to the production plant. To discharge the oil, the process is reversed.

Caverns in rock salt are also suitable for gas storage. For example, natural gas is stored to compensate for seasonal and daily variations in demand. The conversion of a cavern to a gas-storage system is more complex than conversion to liquid storage. To protect the outer piping against pressure and temperature variations during operation, a protective pipe is fitted. The annular space between this pipe and the outer pipe is pressurized so that the welded pipes are under a constant load. For the first filling operation with gas, a brine extraction pipe is lowered to the bottom of the cavern. The gas in the annular space between the protective pipe and the vertical central pipe is compressed to a high pressure, and displaces the brine from the cavern until the latter is completely empty. The gas storage system operates by the principle of compression-decompression. The gas in the cavern required to maintain the minimum residual pressure required for stability of the cavern is called the cushion gas, but when it is filled up to its maximum operating pressure, it is known as the working gas.

Descriptions of cavern storage systems can be found in [146–149]. A worldwide information exchange service is provided by the Solution Mining Research Institute (SMRI), Woodstock, Illinois.

### 51.13.3.4 Production of Sea Salt

**Introduction.** In his *Historia Naturalis*, PLINY THE ELDER already referred to the technique of producing salt by the natural evaporation of sea water. Even today, this method of exploiting the oceans, seas, salt lakes, and chotts is still widespread. It is practiced in nearly all regions of the world where climate and topography allow.

While some methods have changed very little, such as those of the “Paludiers” working

the salt marshes along the Atlantic coast of Portugal and France, other modern methods are now applied, combining productivity with strict environmental protection. This applies to the vast majority of salt fields in the Mediterranean basin, on the west coast of Australia, and Guerrero Negro, the world’s largest salt field in Mexico at the southernmost tip of Baja California.

### The Raw Material: Sea Water

The water of the seas and oceans contains all the known elements, most of them present in small amounts [150]. Sodium chloride is the most important compound in terms of concentration, averaging 28 g/L.

Sea water also contains significant amounts of magnesium, sulfur, and calcium, the other important sea-water-based process being the production of magnesium compounds.

The salinity (grams of salt per kilogram of sea water) of ocean and sea water varies with location and depth [151]. This dispersion, due either to dilution by precipitation or drainage pattern, or to local overconcentration caused by strong evaporation, is more evident in inland seas.

The average salinity is 3.5%, corresponding to a relative density of 1.026. It reaches 4.1% in the Red Sea and is only 3% in the Baltic Sea.

The salt mixture in sea water has the following typical composition (in %) [47]:

|                   |     |
|-------------------|-----|
| NaCl              | 77  |
| MgCl <sub>2</sub> | 10  |
| MgSO <sub>4</sub> | 6   |
| CaSO <sub>4</sub> | 3.9 |
| KCl               | 2   |

### The Main Factors Governing Production of Sea Salt

To produce sea salt economically, the amount of water evaporating must exceed the amount of precipitation (rain or dew) for a long and continuous period of at least three months during the year.

Table 51.8 lists the main types of climate compatible with the production of sea salt. In

Taiwan, a borderline case, sea salt production calls for a maximum of ingenuity. In Western Australia, by contrast, the climate is ideal, notwithstanding the risk of cyclones, and sea salt can be produced all year round.

In practice, evaporation at a given production site is measured over fresh water with an evaporimeter. Since the total concentration of dissolved salts is known, the evaporation is determined approximately from an empirical curve, an example of which is shown in Figure 51.15 [152].

Table 51.8: Typical climatology of solar saltfields [151].

|                                      | South of France | Australia | Indonesia | Taiwan |
|--------------------------------------|-----------------|-----------|-----------|--------|
| Annual evaporation <sup>a</sup> , mm | 1700            | 3600      | 1850      | 1660   |
| Annual rainfall, mm                  | 550             | 300       | 1300      | 1400   |

<sup>a</sup>Fresh water.

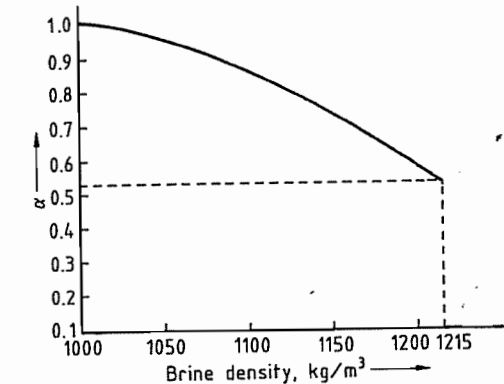

Figure 51.15: Evaporation coefficient  $\alpha$  as a function of density.

1 cm of evaporation over fresh water corresponds to a cm for the body of water in question; a normally ranges from 0.95 for sea water to 0.55 for saturated brines depositing their salt.

In addition to a favorable climate, a particular topography is required, and the ground must be as impermeable as possible to minimize brine seepage.

The pond areas containing the brines or saline solutions must also be as level as possible, ideally below sea level, and stepped in elevation. This reduces the number of intermediate

pumping stations required and helps to optimize the design of the ponds, dikes, channels, and culverts making up the salt field.

These conditions are often satisfied in the deltas of large rivers. The Rhône delta in France’s Camargue is one example, and is the location of two large salt fields: Aigues-Mortes and Salin de Giraud.

**Concentration of Sea Brines.** After being pumped from the sea, the sea water passes through the salt field from pond to pond. As it passes through the ponds, the NaCl concentration in the sea water rises from 28 g/L to roughly 260 g/L, corresponding to an increase in relative density from 1.026 to 1.215. At this point, the brine begins to deposit its salt. Most of the calcium carbonate (CaCO<sub>3</sub>) and calcium sulfate (CaSO<sub>4</sub>·2H<sub>2</sub>O) has already crystallized before this point, as shown in Figure 51.16, while the magnesium salts continue to become concentrated without crystallizing.

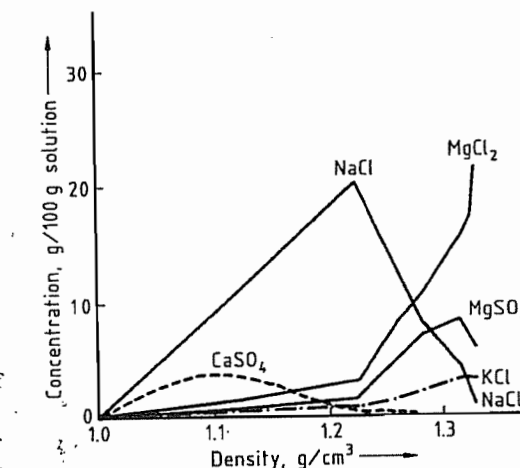

Figure 51.16: Brine composition as a function of density [153]. Values for CaSO<sub>4</sub> concentration are multiplied by a factor of ten.

**Crystallization of Sodium Chloride.** When the brines approach the NaCl saturation point, they are fed through feed channels into the crystallizers, which represent the production units. The floors of the crystallizers must first be carefully prepared by compacting and leveling to ensure easy separation of the salt from the ground and a uniform layer of brine.

The surface area of these crystallizers generally represents ca. 10% of the total area of the salt field.

From this point on, the salt worker's job is to monitor the brine strengths and purge the bitterns from the ponds when the concentration of secondary salts, particularly magnesium salts, is liable to lower the quality of the salt. The ponds are then filled with fresh or pure brine with a low magnesium salt content.

The salt is produced in the form of a layer of tangled crystals whose density and grain size depend on the characteristics of the bittern and, especially, on the turbidity or cloudiness. If the brine is turbid, the suspended fine particles act as seed crystals. If, however, the brine is clear and well settled, the number of seed crystals is greatly reduced, and crystal growth occurs in preference to germination.

The thickness of the salt layer varies from one site to another, and also, at a given site, from one year to another, depending on weather conditions. In the South of France where the production period runs from May to September, the thickness at the end of the season averages 10 cm. At other latitudes, layers may be over 20 cm thick.

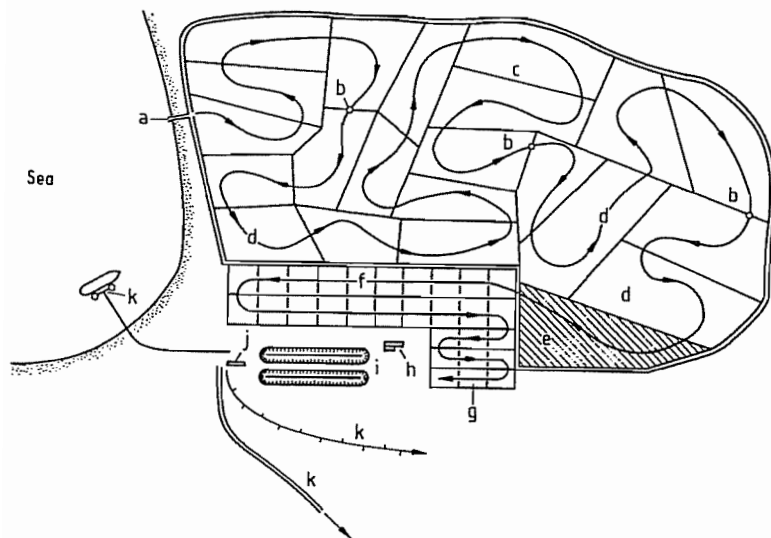

Figure 51.17: Modern salt field [151]: a) Sea water intake; b) Pumping station; c) Dikes; d) Condensers; e) Brine storage tanks; f) Crystallizers; g) Bitterns area; h) Washing plant; i) Salt storage areas; j) Packaging plant; k) Dispatch.

### Production Stages in a Modern Salt Field

Figure 51.17 shows the main components of the infrastructure of a modern salt field, from sea water intake to the production facilities for processing and packaging the salt.

The production process features the following stages:

- **Seawater pumping:** the salt field is supplied with sea water by a pumping station. In some parts of the world, such as Australia, the salt fields are gravity fed with sea water in accordance with the tides. Several million cubic meters of sea water are required annually to produce several hundred thousand tonnes of sodium chloride (the Aigues-Mortes salt field in France pumps  $50 \times 10^6$  m<sup>3</sup> of sea water for an average annual output of 400 000 t).
- **Concentration of sea water in the ponds:** in this stage, the water flows through shallow ponds and is allowed to concentrate until approximately 90% of the initial water content has evaporated. The brines are moved pond to pond by gravity or by pumping as dictated by the local topography.

Table 51.9: Percentage compositions of rock salt from various sources.

|                                 | Borth, Germany | Malagash, Canada | Northwick, England | Stäbfurt, Germany | Retsof, USA |
|---------------------------------|----------------|------------------|--------------------|-------------------|-------------|
| NaCl                            | 98.5           | 99.095           | 93.43              | 97.53             | 98.1        |
| MgCl <sub>2</sub>               | 0.13           | 0.026            | 0.14               |                   | 0.00        |
| MgSO <sub>4</sub>               |                |                  |                    | 0.23              |             |
| CaCl <sub>2</sub>               |                | 0.118            | 0.01               |                   |             |
| CaSO <sub>4</sub>               | 0.75           | 0.401            | 1.16               | 1.49              | 1.60        |
| Na <sub>2</sub> SO <sub>4</sub> | 0.44           |                  | 0.04               | 0.43              |             |
| NaHCO <sub>3</sub>              |                |                  | 0.01               |                   |             |
| Insolubles                      | 0.1            | 0.360            | 5.25               |                   | 0.27        |
| Water                           |                |                  |                    |                   | 0.03        |

- **Deposition of NaCl in the crystallizers:** for a salt field with a single production season during the year, the crystallizers are first filled with brine kept from the previous year, which has been protected from rain dilution in deep storage ponds. A few weeks later, the old brine is replaced by the new concentrated brine leaving the ponds. By the time the relative density of the brine reaches 1.215, when NaCl crystals start to form, the brine has already precipitated 80% of the calcium sulfate in the form of gypsum. The bitterns are then removed before the specific density reaches 1.260 to avoid codeposition of magnesium salts. Where bitterns are present in sufficiently large quantities, and if the climate allows, the bitterns can be concentrated on a bittern salt field to extract the magnesium bromide, magnesium sulfate, and even magnesium chloride.
- **Salt harvesting:** in batch-operated salt fields, salt harvesting begins at the end of the salt production period. For continuous salt fields, harvesting is performed at regular intervals to ensure that the level of the salt does not exceed the operating height of the harvesting machines. The harvester is generally carried by a tractor of the type often used for civil engineering projects. The salt is first scooped off the floor of the crystallizer by a large blade up to 3.6 m wide pushed along by the tractor. It is then lifted by slotted or bucket conveyors. The salt is then evacuated and poured into trailers by a conveyor belt.
- **Transport, washing, and storage:** the harvested salt is loaded onto trucks or tractor-

drawn trailers for transport to a washing plant where most of the impurities are removed.

Washing removes all solid impurities from the salt (substances insoluble in water) along with the accompanying bitterns (solutions of magnesium or potassium compounds). The salt is kept in suspension in saturated brine. The salt-brine mixture is then dewatered and centrifuged. The salt travels up an inclined gantry conveyor and is poured on top of one of the huge salt stockpiles that are a familiar feature of salt production sites.

- **Processing and packaging:** The salt reclaimed from the salt stockpile may be washed a second time, which increases the sodium chloride content to 99%. The salt is then generally dried, crushed, and screened, and anticaking agents are added. Other substances added at this stage include iodide or fluoride in salt for human consumption. The salt is then packaged in various containers (e.g., boxes, polyethylene bags), as required by the consumer.

#### 51.13.4 Production of Pure Salt by Evaporation of Brine

Salt can be produced by evaporation of saturated brine. The brine is generally obtained by dissolving crude salt that contains many impurities. The production of high-purity salt requires chemical purification of the brine. The high purity is the major difference to rock salt (Table 51.9). Purification is also necessary to avoid scale formation in the evaporation equipment. Also, when pure salt is used in in-

dustrial processes, much less waste is produced than when rock salt is used, and this aspect is of ever-increasing importance.

#### 51.13.4.1 Purification of Crude Brine

The most common and most problematic impurities in crude salt are the sulfates and carbonates of calcium and magnesium, and polyhalite ( $K_2SO_4 \cdot 2CaSO_4 \cdot MgSO_4 \cdot 2H_2O$ ). The principal impurities of crude brine are therefore calcium, magnesium, and sulfate ions. The following chemical methods are used to purify crude brine [154].

**Purification with Lime or Caustic Soda and Soda Ash.** Magnesium ions are precipitated from the crude brine as magnesium hydroxide by adding calcium or sodium hydroxide. Calcium ions are precipitated as calcium carbonate by adding sodium carbonate or by purging the alkaline brine with carbon dioxide, usually in the form of combustion gas. Salt is obtained from the purified brine by evaporation, which is stopped prior to the onset of sodium sulfate crystallization. The mother liquor has a high sodium sulfate content and can be used for sodium sulfate production.

**Purification in a Circulating System.** Here, the brine is usually treated in two stages. In the first stage, crude brine, mother liquor, and calcium hydroxide suspension or sodium hydroxide solution are brought together and thoroughly mixed. This causes magnesium hydroxide and calcium sulfate to precipitate. Other metal ions are precipitated in addition to the alkaline earths. After removal of these solids, sodium hydroxide solution and/or sodium carbonate solution are sometimes added to the clear brine, which is saturated with calcium hydroxide, in the second stage. Also, carbon dioxide (usually as combustion gas) is passed through, whereby calcium carbonate crystallizes and is removed. The clarified brine is fed to the evaporator, and evaporated until sodium sulfate just fails to crystallize. The salt is recovered, and the mother liquor, which has a

high sodium sulfate content, is recycled to the first stage of the brine purification process.

**Design of Brine Purification Plants.** The brine purification processes described above were formerly carried out as batch operations, but today continuous processes are more common. In both methods, the impurities are allowed to settle and then removed. Sedimentation is accelerated by adding flocculating agents, usually polyacrylamides sometimes in combination with iron hydroxide. In the continuous process, the solid impurities are removed in thickeners. Modern brine purification plants are often fully automated, and are controlled by means of automatic analyzers.

#### 51.13.4.2 Evaporation of Brine

As the solubility of sodium chloride increases only slightly with temperature (Table 51.4), the salt is normally crystallized out in an evaporative crystallizer at 50–150 °C. Both pure brine and crude brine are evaporated.

When evaporating crude brine, the gypsum slurry process is used, in which a certain quantity of crystalline calcium sulfate is maintained in the suspension of salt crystals. The calcium sulfate that precipitates deposits on these gypsum crystals and hence does not form a scale on the heating surfaces or the walls of the vessel.

Salt was formerly produced by evaporation in open pans. Due to the high heat consumption and relatively poor performance, this method is now hardly used [154, 155]. To achieve the best possible utilization of heat, multistage evaporation and vapor recompression were developed.

In the multistage evaporation process, improved heat utilization is achieved by compressing the vapors from the first evaporator and using these for heating the second. The vapors from the second evaporator are then used to heat the third, and so on. The plant generally has four, five, or six stages. The brine is preheated in preheaters which are heated with vapor and condensate from the evaporators.

The heat of the vapor can be used in the same evaporator if the vapor is compressed to a higher pressure [156]. This system is widely used where cheap electrical energy is available. In this case, only one evaporator is required. Reductions in power costs and hence operating costs can be achieved by switching off the electrically powered turbine compressor during periods of peak electricity consumption.

Hybrid systems are also used, which can be operated as multistage or vapor-compression evaporators [157]. Combined methods are also used in which high-pressure steam is passed through back pressure turbines, and the exhaust steam heats a multistage evaporation plant. The mechanical power is available for compressing the vapors.

In general, three types of crystallizers are used [158, 159]:

Type 1: Evaporators with forced circulation and external heating.

Type 2: Evaporators with internal heaters and a circulating pump in the central pipe producing forced circulation.

Type 3: Oslo crystallizers (Figure 51.18)

In Oslo crystallizers, recirculating brine and fresh brine are heated in the heat exchanger and evaporated in the evaporator. The supersaturated crystal-free brine passes down the central pipe into the crystallizer, and from there passes upwards through the bed of crystals.

The choice of crystallizer depends on the desired crystal size. If crystal size is not important, Type 1 crystallizers are generally used. These produce cubic crystals with 50% > 400 μm (by sieve analysis). If somewhat coarser salt is desired, Type 2 crystallizers are used, giving cubic crystals with rounded corners, with 50% > 650 μm (sieve analysis). Type 3 crystallizers produce a granular product, with lenticular or spherical particles, ca. 1–2 mm in size.

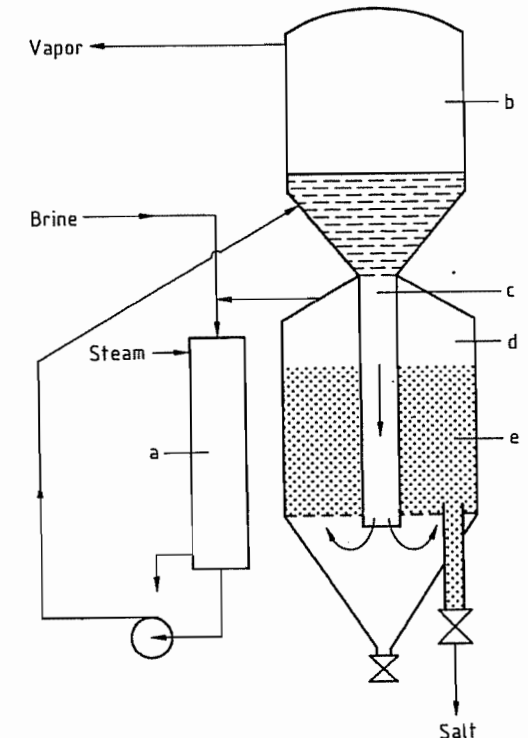

Figure 51.18: Oslo evaporator: a) Heat exchanger; b) Vacuum evaporator; c) Down pipe; d) Crystallizer; e) Bed of crystals.

#### 51.13.4.3 Recrystallization

The recrystallization process utilizes the fact that the solubility of calcium sulfate in brine decreases with increasing temperature, while that of sodium chloride increases slightly. The process is suitable for producing a fairly pure salt from fine or waste salt [154, 160].

The process consists of three stages:

- **Dissolution:** Fine salt is heated with mother liquor from the evaporator to ca. 105 °C in a dissolving vessel by passing steam into it. The sodium chloride dissolves, but not the calcium sulfate, because the brine from the mother liquor is already saturated with calcium sulfate.
- **Filtration:** Removal of solid calcium sulfate and other solid impurities from the brine.

● **Crystallization:** The clear brine is pumped to the crystallizer, which is an expansion evaporator with forced circulation but without heaters. On expansion, evaporation and cooling take place. The salt suspension is removed from the evaporator and the mother liquor is returned to the dissolution vessels.

Heat exchangers are not generally used in this process, which can be carried out in one or several stages.

#### 51.13.4.4 Other Process Steps

**Manufacture of Special Salt Crystals.** Salt crystals with special shapes can be produced by adding substances that affect crystal growth to the brine in the evaporation equipment. The addition of soluble iron(II) cyanide complexes in amounts of ca. 10 mg/kg (expressed as the amount of additive in the product) produces dendritic crystals. This salt has a very low bulk density of ca. 0.8 g/cm<sup>3</sup>. Other suitable additives include nitrilotriacetic acid, nitrilotriacetamide, sodium hexametaphosphate, and cadmium chloride [161, 162].

Coarse salt is also produced by compressing fine salt to form tablets or briquettes, or into compacted sheets that are then broken up to form coarsely granular salt [154].

**Construction Materials.** To avoid corrosion [154, 163], the material of the evaporator is usually made of steel plated with a monel alloy. Less critical parts of the equipment can be made of steel. Rubber-coated equipment is also used. The tube sheets are of steel or monel metal and the heat-exchanger tubes are generally made of copper nickel alloy or titanium.

**Removal of the Crystals.** The crystal suspension is removed from the evaporators, which are often conical at the bottom. Fresh brine is often fed in through a discharge branch, which washes the salt crystals and causes thickening of the suspension.

**Salt Drying.** The mother liquor is removed from the crystal suspension in centrifuges. Sometimes the salt crystals are washed in a pusher centrifuge. If washing is not required, a screw centrifuge can be used. After centrifug-

ing, the salt still contains ca. 2–3% moisture. Further drying can be carried out in rotary driers, but fluidized bed driers are now more common. At the end of the fluidized-bed dryer there is usually a cooling zone into which cold air is blown, or a separate cooler can be used. The dried salt is often passed through a classification process.

#### 51.13.4.5 Salt Quality

Typical analyses of salt produced by the evaporation of crude or purified brine are given in Table 51.10. Anticaking agents such as sodium, potassium, or calcium ferrocyanide are added at a concentration of 5–15 mg/kg. Purity requirements for salt are continually increasing, especially for industrial applications such as chlor-alkali electrolysis. As salt purity improves, the amount of waste decreases, and the environmental pollution caused by the wastewater is substantially reduced.

**Table 51.10:** Typical analyses of salt from evaporation processes.

|                         | From crude brine [154] | From purified brine |
|-------------------------|------------------------|---------------------|
| NaCl, %                 | 99.7                   | 99.95               |
| SO <sub>4</sub> , mg/kg | 1900                   | 300                 |
| Ca, mg/kg               | 900                    | 7                   |
| Mg, mg/kg               | 20                     | 0.5                 |

### 51.13.5 Economic Aspects

#### 51.13.5.1 Commercial Grades

**Salt for Food.** Salt intended for human consumption is known as cooking salt or table salt. Apart from its function as a seasoning in foods, it is of vital importance for the human organism. The average daily salt requirement for humans is 7 g [164]. In Germany, the fraction of total salt consumption used for food is only 3%. In 1990, the consumption of table salt was ca. 398 000 t. The largest use in the food industry is for food preservation. Only ca. 100 000 t is sold in small packages for household use [165]. Caking of table salt is prevented by adding anticaking agents such as calcium or magnesium carbonate, or sodium or potassium ferrocyanide [166].

Table salt is used as a carrier for various active substances. Iodized table salt is important worldwide in the prevention of diseases of the thyroid gland. Fluoridized table salt is used to prevent tooth decay.

In Europe, ca. 90% of all meat products are preserved with nitrite pickling salt, which consists of sodium chloride and various amounts of sodium nitrite [165].

**Treated Salt.** Salt that is used neither as a foodstuff nor for the chemical industry is denatured in many countries for tax reasons. The consumption of this type of salt in Germany in 1990 was ca. 800 000 t.

Salt that is not suitable for human consumption or food production is produced on demand by the addition of denaturants such as eosin, patent blue, or soda ash.

Treated salt is used for water softening, textile treatment, in the leather industry, in animal food production, and in many other fields.

Of the above, the regeneration of water softeners is a very important application [167]. Water softening is essential owing to the widespread occurrence of hard water, and so far there is no alternative to the long-estab-

lished and well proven method based on ion exchangers and salt.

**Industrial salt** is salt that is used as raw material for producing other compounds [168, 169]. The main applications of industrial salt in the chemical industry are in chlor-alkali electrolysis and sodium carbonate production.

The products obtained form the basic raw materials for innumerable other products, including glass, dyes, washing and cleansing agents, medicines, plastics, aluminum, and paper (Figure 51.19).

In Germany in 1990, ca. 4.5 × 10<sup>6</sup> t crystalline salt was used, and ca. 5.9 × 10<sup>6</sup> t in the form of brine.

As with all forms of salt, industrial salt is subject to tax laws, but it may be used without being denatured if a salt license has been issued. For technical reasons, no anticaking agents are added to industrial salt.

**Deicing Salt.** Rock salt and sea salt can be used for deicing road surfaces to give safe driving conditions for traffic in winter. The chemical processes (hydration) that take place when deicing salt comes into contact with snow and ice on the roads in winter effectively eliminate slippery conditions [171].

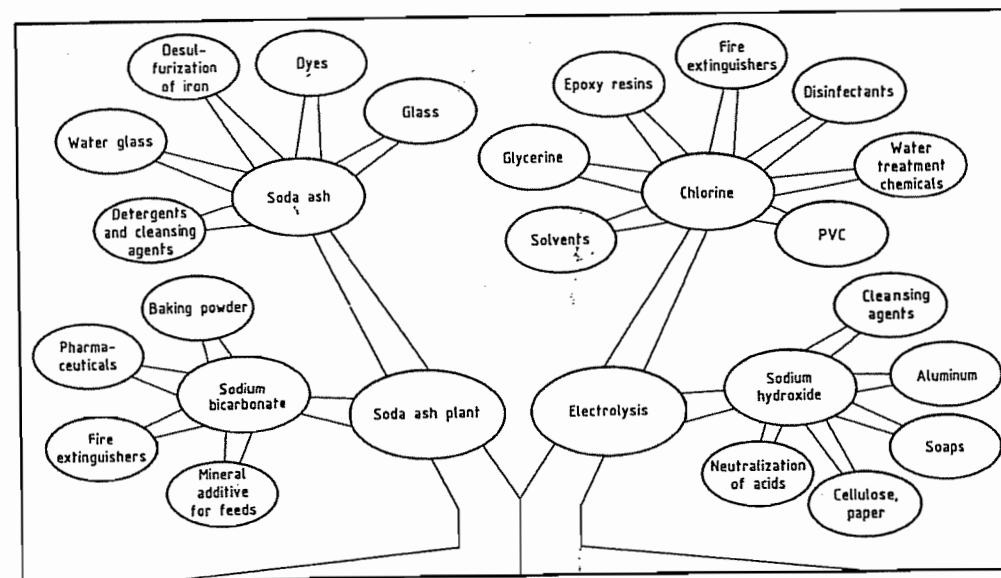

**Figure 51.19:** Family tree of salt chemistry [170].

The effect of deicing salt on the environment has been the subject of controversy. However, in the wake of mounting evidence from scientifically based investigations, there is now little opposition to the sparing application of deicing salt to ensure the safety of traffic, and the frequency of accidents caused by snow and ice can be drastically reduced.

The development and use of suitable technology have contributed greatly to decreasing the amount of deicing salt used and hence to reduction of environmental pollution. This technology makes use of modern electronic equipment for automatically adjusting the salt spreading process to the width of the road and the speed of the gritting vehicles, and the spreading of moist salt.

For the spreading of moist salt, the dry salt is wetted with a 5–30% solution of sodium chloride, calcium chloride, or magnesium chloride. Moistening prevents windblown losses and gives a more rapid deicing effect [171].

In the 1960s, at least 40 g/m<sup>2</sup> deicing salt was required, but subsequent technical developments have enabled an optimum deicing effect to be achieved with only 10 g/m<sup>2</sup>. In 1990, ca. 630 000 t of deicing salt was used in Germany.

### 51.13.5.2 Packaging, Transport, and Storage

Salt is supplied both loose and in packaged form. Salt for human consumption is available in big bags, in plastic and paper sacks, and in small packets. Denatured salt and deicing salt are supplied loose or in packages, but salt intended for large-scale industrial use is only supplied in loose form.

Salt is transported by canal and river boats, or by road in tipping trucks, flat trucks, or silo trucks.

## 51.14 Sodium Hydroxide

Pure sodium hydroxide, NaOH, is a colorless solid. It does not occur in nature, but is manufactured on a large scale from fairly

readily obtainable raw materials and is used in numerous chemical processes. Because of its corrosive action on many substances, it is known as caustic soda.

Sodium hydroxide solution is one of the oldest man-made chemicals. The reaction of sodium carbonate with calcined limestone (causticization of soda) was already known in early Afro-Oriental cultures. Alabaster vessels containing 3% sodium hydroxide solution have been found in Egyptian tombs dating from 3rd century B.C. near the Pyramid of Cheops. The first written records of caustic soda production during the early years A.D. came from Egypt and India.

### 51.14.1 Properties

Because pure sodium hydroxide has a high affinity for water, the physical and chemical properties of the pure substance are difficult to determine. Many of the data are obtainable only by extrapolating values for impure sodium hydroxide. The same is true for the concentration-dependent physical properties of aqueous solutions of sodium hydroxide, since these solutions have a strong tendency toward supersaturation.

#### 51.14.1.1 Properties of Sodium Hydroxide

Some physical properties of solid sodium hydroxide are as follows:

|                                 |   |
|---------------------------------|---|
| Appearance                      | white, crystalline                      |
| Density (liquid, 350 °C)        | 1.77 g/cm <sup>3</sup>                  |
| mp (soda and water free)        | 322 ± 2 °C                              |
| Heat of fusion                  | 6.77 kJ/mol                             |
| Boiling point at 0.1 MPa        | 1388 °C (calculated)                    |
| Specific heat capacity at 20 °C | 3.24 J kg <sup>-1</sup> K <sup>-1</sup> |

Pure sodium hydroxide is strongly hygroscopic. It dissolves in water with liberation of heat and forms six defined hydrates (Figures 51.20, 51.21, and Table 51.11). When transporting and storing sodium hydroxide solution, the containers must be heated or insulated because the melting points of some of the hydrates are much greater than 0 °C. In the presence of moisture, NaOH reacts readily with atmospheric carbon dioxide to form so-

dium carbonate. Sodium hydroxide reacts with carbon monoxide under pressure and in the presence of moisture to yield sodium formate.

The high affinity of sodium hydroxide for water causes a reduction in water vapor pressure (e.g., to 0.36 kPa for 50.3%, NaOH at 30 °C). Sodium hydroxide is therefore a very effective drying agent. It is fairly readily soluble in methanol and ethanol.

Anhydrous sodium hydroxide reacts very slowly with most substances. For example, it attacks many metals only slightly at room temperature (e.g., Fe, Mg, Ca, and Cd). However, corrosion rates increase rapidly with increasing temperature. More noble metals such as nickel, silver, gold, and platinum are attacked only slightly even when heated, especially if oxidizing atmospheres are excluded. Anhydrous sodium hydroxide does not react with dry carbon dioxide.

#### 51.14.1.2 Properties of Sodium Hydroxide Solution

**Physical Properties.** The concentrations of the aqueous solutions in equilibrium with solid NaOH at various temperatures are given below:

|               |      |      |      |      |      |      |
|---------------|------|------|------|------|------|------|
| <i>t</i> , °C | 10   | 18   | 30   | 40   | 53   | 64   |
| % NaOH        | 49.8 | 51.0 | 53.3 | 55.4 | 59.7 | 69.0 |

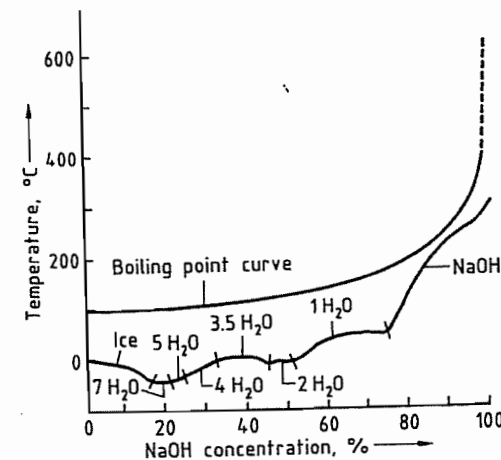

Figure 51.20: The NaOH–H<sub>2</sub>O system.

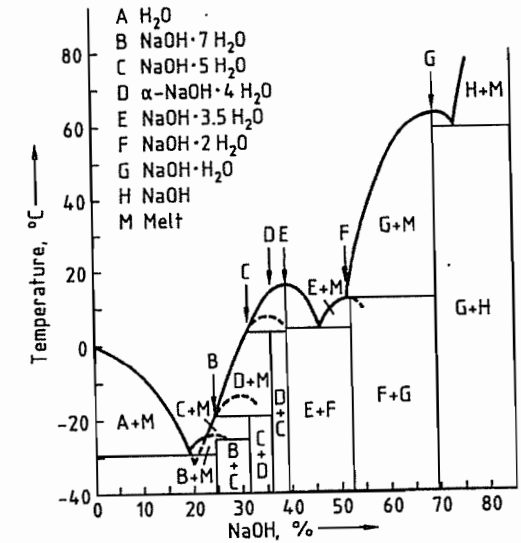

Figure 51.21: The NaOH–H<sub>2</sub>O system [172].

Table 51.11: Stability of the hydrates of sodium hydroxide.

| Formula                             | Stability range, °C         |
|-------------------------------------|-----------------------------|
| NaOH·7H <sub>2</sub> O              | –23.5 to –28.3 <sup>a</sup> |
| NaOH·5H <sub>2</sub> O              | –12.2 to –31.9 <sup>a</sup> |
| α-NaOH·4H <sub>2</sub> O            | +7.6 to –21.4 <sup>a</sup>  |
| β-NaOH·4H <sub>2</sub> O (unstable) | –1.7 to –14.5 <sup>a</sup>  |
| NaOH·3.5H <sub>2</sub> O            | +15.6 to –8.8 <sup>b</sup>  |
| 9NaOH·28H <sub>2</sub> O (unstable) | +2.7 to –2.5 <sup>a</sup>   |
| NaOH·2H <sub>2</sub> O              | 0 to +12.5 <sup>c</sup>     |
| NaOH·H <sub>2</sub> O               | +4.5 to +64.3 <sup>b</sup>  |

<sup>a</sup>Unstable melting point.

<sup>b</sup>Clearly defined melting point.

<sup>c</sup>Melting point can be determined only by extrapolation.

The heat of solution is ca. 44 kJ/mol at 18 °C. The surface tension at 20 °C increases from  $7.46 \times 10^{-2}$  N/m for a 5% solution to 0.1 N/m for a 35% solution [173]. A 1 mol% solution has a surface tension of  $7.43 \times 10^{-2}$  N/m at 20 °C, which decreases to  $6.23 \times 10^{-2}$  N/m at 90 °C. The density of aqueous sodium hydroxide solution in the concentration range 0–20% can be calculated from the formula:

$$d_1 = d_2 + (1.16027 \times 10^{-2} - 2.511 \times 10^{-5} t + 1.0222 \times 10^{-7} t^2)p - (1.0817 \times 10^{-5} - 3.6748 \times 10^{-7} t + 2.034 \times 10^{-10} t^2)p^2$$

where  $d_1$  (g/cm<sup>3</sup>) = density of solution at  $t$  °C,  $t$  (°C) = temperature,  $p$  (%) = g NaOH/100 g solution,  $d_2$  (g/cm<sup>3</sup>) = density of water at  $t$  °C.

The densities of more concentrated aqueous sodium hydroxide solutions at 20 °C are as follows:

| [NaOH], % | Density, g/cm <sup>3</sup> |
|-----------|----------------------------|
| 20        | 1.219                      |
| 30        | 1.328                      |
| 40        | 1.430                      |
| 50        | 1.525                      |

The boiling point curve is shown in Figure 51.20. In the concentration range 0–60%, NaOH, the boiling point increases approximately linearly with temperature.

|                       |     |      |      |      |      |
|-----------------------|-----|------|------|------|------|
| NaOH concentration, % | 5.9 | 23.1 | 33.8 | 48.3 | 54.6 |
| Boiling point, °C     | 105 | 110  | 120  | 140  | 150  |

A 5-g/L solution of sodium hydroxide in water is almost completely dissociated. Activity coefficients are in the range  $\alpha = 0.784$  (0.1 M at 10 °C) and  $\alpha = 3.922$  (15 M at 70 °C).

**Chemical Properties.** Amphoteric metals such as zinc, aluminum, tin, and lead are attacked by dilute sodium hydroxide solution at room temperature. Iron, stainless steel, and nickel are fairly resistant.

### 51.14.2 Production

Sodium hydroxide is produced commercially in two forms: a 50% solution (the most common form) and in the solid state (caustic soda) as prills, flakes, or cast shapes.

#### 51.14.2.1 Production of Sodium Hydroxide Solution

**Electrolysis of Sodium Chloride.** Sodium hydroxide solution is produced industrially mainly by the electrolysis of sodium chloride. This yields sodium hydroxide solution, chlorine, and hydrogen in the mass ratio 1:0.88:0.025 in accordance with the following overall equation:

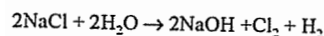

In the early 1980s, the membrane process was introduced, the other processes in operation at that time being the amalgam and diaphragm processes. Chlor-alkali production in 1990 was divided between these three processes as shown in Table 51.12.

**Table 51.12:** Distribution of chlor-alkali production among the three most widely used processes (percentage of installed capacity in 1994) [174, 175].

| Process   | North America | Western Europe | Japan |
|-----------|---------------|----------------|-------|
| Amalgam   | 14            | 65             | 0     |
| Diaphragm | 78            | 25             | 15    |
| Membrane  | 6             | 6              | 85    |
| Others    | 2             | 4              | 0     |

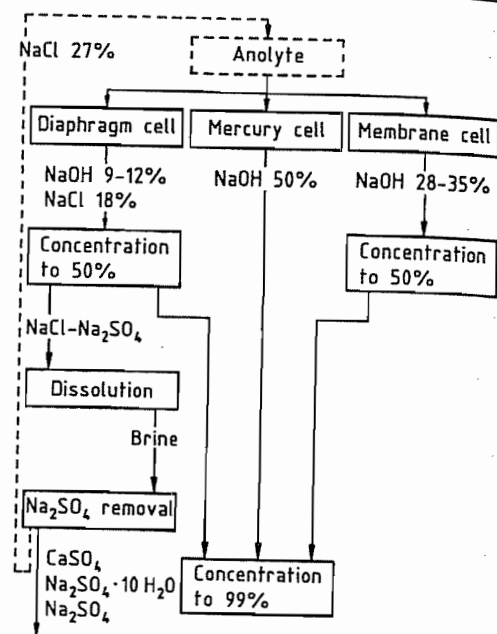

**Figure 51.22:** Treatment of the sodium hydroxide solution from electrolysis cells [176].

In Japan, by 1988 all plants based on the amalgam process had been either shut down or converted to the membrane process. Some Japanese diaphragm plants were also replaced by membrane plants for reasons of both cost and quality.

Treatment of the liquor from the electrolytic cell is shown schematically in Figure 51.22. In the amalgam process, sodium hydroxide solution is produced from sodium amalgam and water over a graphite catalyst at 80–120 °C. The 50% solution produced is very pure. It is cooled, mercury is removed by centrifugation or filtration through cartridge or pressure plate filters, and it is then sold without further treatment.

In the diaphragm cell, the depleted sodium chloride solution from the anode compartment is transferred quantitatively to the cathode compartment, so that the cell liquor produced there contains ca. 18% sodium chloride and 9–12% sodium hydroxide. During evaporation to give a 50% NaOH solution, all the impurities carried over with the depleted sodium chloride solution are removed to their limiting solubility by fractional crystallization; thus the sodium chloride content can only be reduced to ca. 1–1.5%. In the DH process of the PPG Company, further purification is carried out by extraction with anhydrous liquid ammonia. This gives a product comparable to that from the amalgam process (rayon quality), but the process is seldom used because of cost. This is also true of a Japanese process in which a relatively pure sodium hydroxide solution is obtained by cooling the 50% diaphragm liquor and recovering the crystals of pure NaOH·3.5H<sub>2</sub>O formed. Methods of optimizing the various evaporation systems used for treating liquor from the diaphragm cell are described in [177].

In the membrane process, a hydraulically impermeable membrane prevents mixing of the electrolytes. This process produces a high-purity, virtually chloride-free sodium hydroxide solution comparable to that of the amalgam process. However, the chloride content increases by a factor of ca. 10 if operation of the cell is interrupted, due to diffusion of Cl<sup>-</sup> ions through the membrane. The sulfate and chlorate present in the anolyte also affect the concentration of these impurities in the caustic liquor from the membrane cell, since the cation-selective membrane has an appreciable residual permeability for anions. Most membrane cells give optimum economic performance at an NaOH concentration of 30–35%. An ion-exchange membrane has now been developed that enables a 50% sodium hydroxide solution to be produced in the cell [178], although a considerable increase in

voltage is required. Such membranes are viable only if steam costs are high and electricity costs low [179]. The 30–35% sodium hydroxide solution is usually concentrated in a two- or three-stage falling-film evaporator (depending on steam costs and plant size) to give a commercial 50% solution (see Figure 51.23). For a three-stage evaporator, the steam consumption is 0.55 t/t NaOH (100%), and for a two-stage evaporator, 0.71 t/t NaOH (100%), with sodium hydroxide solution and steam in countercurrent flow.

The evaporation of membrane cell liquor (unlike that of diaphragm cell liquor) does not produce any solid material that can foul the heat exchanger or erode the pipework. The pickup of metals during evaporation is < 1 ppm if appropriate construction materials are used (nickel, stainless steel). The various evaporation techniques are described in [176], with special reference to the concentration of membrane cell liquor.

As shown in Table 51.13, the three electrolytic processes have different energy requirements. The membrane process consumes the least electrical energy (2300–2500 kWh/t NaOH) but requires an additional 180 kWh/t NaOH in the form of steam to produce a 50% solution. The diaphragm process consumes less electrical energy than the amalgam process but requires 900 kWh/t NaOH as steam for the evaporation stage and therefore has the highest total energy requirement.

**Table 51.13:** Energy requirements for the production of 1 t of sodium hydroxide (as 50% solution) by the three electrolytic processes.

| Energy, kWh/t NaOH <sup>a</sup> | Process   |           |           |
|---------------------------------|-----------|-----------|-----------|
|                                 | Amalgam   | Diaphragm | Membrane  |
| Electricity                     | 2800–3200 | 2500–2600 | 2200–2500 |
| Steam (equivalent)              | 0         | 799–900   | 90–180    |
| Total                           | 2800–3200 | 3200–3500 | 2290–2680 |
| Relative energy costs, %        | 90        | 100       | 70        |

<sup>a</sup> The energy requirement given is based on the production of NaOH, Cl<sub>2</sub>, and H<sub>2</sub>.

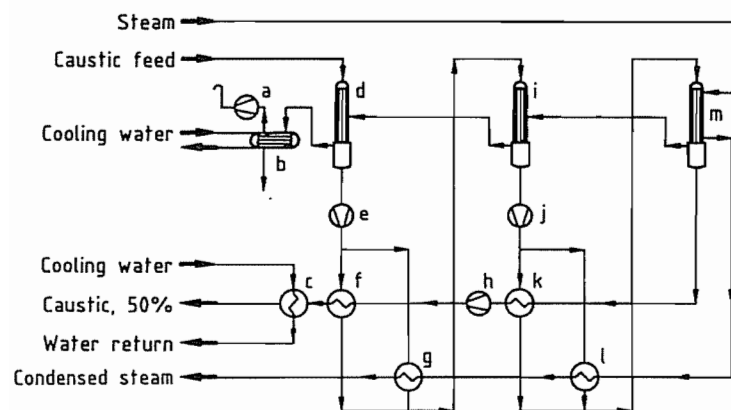

**Figure 51.23:** Membrane cell caustic evaporation (Bertrams process): a) Vacuum pump; b) Condenser; c) Caustic cooler; d) First evaporator; e) Caustic pump; f) First caustic heat exchanger; g) Second heat exchanger; h) Caustic pump; i) Second evaporator; j) Caustic pump; k) Second caustic heat exchanger; l) First heat exchanger; m) Third evaporator.

Because of the high consumption of electrical energy, much research has been aimed at reducing the cell voltage. A ca. 1 V reduction can be achieved by using an oxygen-consuming cathode (as in a fuel cell) in the membrane cell process, although in this case no by-product hydrogen is produced. These cells have not been used on a production scale because of major technical difficulties.

The electrolysis of fused NaCl at 350 °C with a  $\beta$ -Al<sub>2</sub>O<sub>3</sub> diaphragm is also of interest. In laboratory-scale cells, a power consumption of 2350 kWh/t NaOH can be attained [180]. This technique, too, has yet to be used on a commercial scale.

**Other Processes.** Processes not linked to chlorine production are currently coming back into favor, as future world demand for sodium hydroxide solution is expected to exceed that for chlorine [181, 182]. The causticization of sodium carbonate solution is the oldest method of producing sodium hydroxide and was the only method available until the introduction of electrolysis. Although it had almost disappeared from use, it is now of special interest for companies with access to synthetic sodium carbonate from the Solvay process or to natural sodium carbonate (e.g., trona, Na<sub>3</sub>H(CO<sub>3</sub>)<sub>2</sub>·2H<sub>2</sub>O). In this process, a hot, ca. 12% solution of sodium carbonate is mixed

with quicklime. The calcium carbonate that precipitates according to the equation

$$\text{Na}_2\text{CO}_3 + \text{CaO} + \text{H}_2\text{O} \rightarrow 2\text{NaOH} + \text{CaCO}_3$$

is removed, and the ca. 12% solution of sodium hydroxide is evaporated in several stages. The impurities that precipitate, mainly NaCl and Na<sub>2</sub>SO<sub>4</sub>, are filtered off. In a process operated by Tenneco, the calcium carbonate produced is converted back to calcium oxide and recycled. In 1991, this company started a new plant producing 75 000 t/a of 50% sodium hydroxide from trona in Green River, Wyoming. Further details on the causticization of sodium carbonate are given in [183].

In a combination of electrolytic and dialysis cells, sodium salts can be split into the corresponding acids and alkalis, e.g.,

$$\text{Na}_2\text{SO}_4 + 2\text{H}_2\text{O} \rightarrow 2\text{NaOH} + \text{H}_2\text{SO}_4$$

This reaction can be carried out in a two-chamber cell with a cation- or anion-exchange membrane; in a three-chamber cell with a cation-exchange and an anion-exchange membrane; or in a multichamber cell with a combination of cation, anion, and bipolar membranes [184–187]. However, in all industrially operated cells, the product is a dilute sodium hydroxide solution (15–30%), which also contains some of the salt used as starting material. For this reason, this type of process is most suitable for treating sodium-salt containing wastewater from processes in which

the dilute sodium hydroxide solution obtained can be recycled for neutralization purposes.

An alternative method of producing sodium hydroxide solution for small paper pulp plants, the ferrite recovery process, is described in [188]. Here, waste liquor containing sodium salts and organic substances is evaporated, and the residue is mixed with Fe<sub>2</sub>O<sub>3</sub> and calcined. The sodium ferrite formed is decomposed by water to give NaOH and Fe<sub>2</sub>O<sub>3</sub>.

### 51.14.2.2 Production of Solid Sodium Hydroxide

Solid sodium hydroxide (caustic soda) is obtained by evaporating sodium hydroxide solution until the water content is < 0.5–1.5%. The most efficient utilization of energy is achieved with multistage equipment. A flow diagram of a plant constructed by Bertrams, Basel (Switzerland), is shown in Figure 51.24.

A 50% solution is vacuum evaporated in a preconcentration unit, by using the heat of the vapor from the main concentrator, until the concentration reaches ca. 60%. In the second stage, a concentration of ca. 99% is attained by heating with a molten salt heat-transfer medium (NaNO<sub>2</sub>–NaNO<sub>3</sub>–KNO<sub>3</sub>) at > 400 °C in a falling-film evaporator. The product is fed to a flash evaporator that operates as a gaslift pump. Molten NaOH is raised by vacuum into a heated riser pipe, causing the remaining water to evaporate. The rising steam bubbles lift the melt to the highest point of the system, where the steam is pumped off. The almost anhydrous melt passes through a downcomer pipe into the holding vessel, from which it is pumped to the conditioning plant. The holding vessel, pumps, and pipes must be heated to prevent premature crystallization.

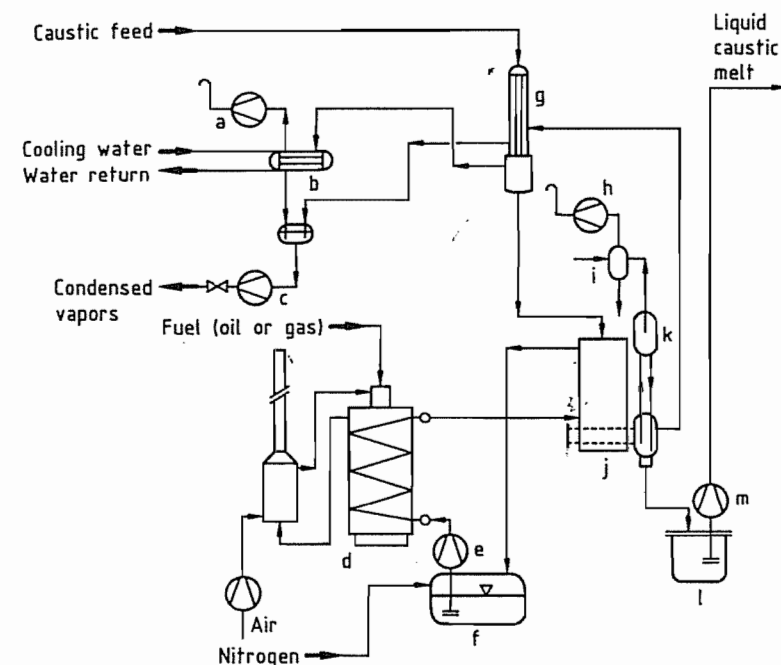

**Figure 51.24:** High-concentration unit for caustic soda (Bertrams process): a) Vacuum pump; b) Condenser; c) Condensate pump; d) Furnace unit; e) Salt melt pump; f) Heated salt melt tank; g) Preconcentration unit; h) Vacuum pump; i) Condenser; j) Falling-film concentrator; k) Flash evaporator; l) Heated caustic melt tank; m) Caustic melt pump.

### 51.14.2.3 Forming

When the NaOH melt is cooled and formed, both the solidification point of NaOH (322 °C) and that of the monohydrate, NaOH·H<sub>2</sub>O (62 °C), must be passed through quickly to prevent caking due to unsolidified monohydrate.

Solid sodium hydroxide is supplied in the form of flakes, prills, cast blocks, and less commonly as tablets, briquettes, or granules. Flakes have a bulk density of ca. 0.9 kg/dm<sup>3</sup>, a thickness of ca. 1.5 mm, and a diameter of 5–20 mm, and are easily broken so that some dust is always formed on handling. Prills have a bulk density of > 1 kg/dm<sup>3</sup> and consist of spheres with a diameter of 0.1–0.8 mm (microprills) or 0.5–2.5 mm.

**Flakes.** To produce flakes, molten NaOH is fed into a trough in which an internally cooled drum rotates. The molten material solidifies on the surface of the partially immersed drum and is scraped off by a knife, which breaks up the sheet of NaOH into flakes. These are taken to a small intermediate storage silo and packed as soon as possible in sacks or steel drums. The material tends to bridge due to its particle shape, so that it cannot be stored in large silos or be transported by compressed air.

**Prills** are produced by spraying the molten material at ca. 360 °C to form droplets. The spray equipment used can be nozzles (outdated), or a spinning disk or basket. The finely divided melt forms spheres of fairly uniform diameter due to surface tension. These are cooled to ca. 250 °C as they fall down a shaft in which air flows upward. The prills are collected in a funnel from which they run into a cooling drum where they are cooled to ca. 50 °C. The finished product is stored in silos (Figure 51.25).

Unlike flakes, prills are free flowing. Also, they do not cake as readily and thus can be stored in silos, transported in containers or other large vessels, or moved by compressed air, because they are almost dust free.

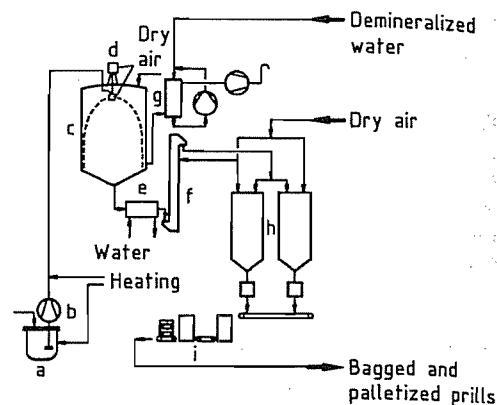

Figure 51.25: Production of sodium hydroxide prills (Bertrams process): a) Caustic melt tank; b) Caustic melt pump; c) Spray tower; d) Rotating spray system; e) Product cooler; f) Elevator; g) Exhaust air treatment; h) Silo; i) Bagging and pelletizing.

**Cast Blocks.** Molten NaOH is directly cast into iron drums or similar containers. The drums are externally cooled intensively by spraying with water, so that a solid film of sodium hydroxide forms immediately on the walls of the container, preventing further contamination by the iron.

**Special Shapes.** Tablets, pills, or pellets are produced by the droplet process. Molten NaOH drops from a special device made of silver onto a slowly rotating cooled table or conveyor belt (pill machine). The product has a very low content of metallic impurities, so that this process is especially suitable for producing small quantities (e.g., for analytical purposes).

### 51.14.2.4 Specifications

Diaphragm liquor cannot be used in all applications (e.g., for artificial silk manufacture or various organic processes) because of the amounts of chloride, chlorate, and heavy metals present.

When corrosion-resistant materials are used for sodium hydroxide production (nickel and stainless steel), the pickup of metal (Ni, Fe) is < 1 ppm. Solid caustic soda should have a pure white appearance. The most important

impurities in solid sodium hydroxide are listed in Table 51.14.

Table 51.14: Product quality: typical percentage analyses of sodium hydroxide from chlor-alkali electrolytic processes.

|                                 | Amalgam process  | Diaphragm process |
|---------------------------------|------------------|-------------------|
| NaOH                            | 99–99.5          | 98–99             |
| NaCl                            | 0.03–0.05        | 1–2               |
| Na <sub>2</sub> CO <sub>3</sub> | 0.2–0.4          | 0.65              |
| Na <sub>2</sub> SO <sub>4</sub> | 0.03             | 0.035             |
| Ca                              | 0.002            | 0.001             |
| Mg                              | 0.0005           | 0.0004            |
| Fe                              | 0.001            | 0.0006–0.0015     |
| Al                              | 0.001            | 0.0005            |
| Ni                              | 0.0002–0.0004    | 0.0002–0.0004     |
| Hg                              | 0.000001–0.00001 |                   |
| mp, °C                          | 322              | 322               |

### 51.14.2.5 Storage, Packaging, and Transportation

Iron, stainless steel, and nickel are suitable materials for containers used for transport and storage, as well as for pipelines. However, corrosion resistance is not the sole criterion for the choice of material. Stress corrosion cracking, changes in the crystal structure, and pitting can cause sudden material failure, so that a more expensive material is often chosen for safety reasons.

Vessels for holding aqueous solutions of sodium hydroxide are usually constructed of alkali-resistant steel. However, at > 50 °C or in the presence of oxygen, iron is slowly attacked by sodium hydroxide solution. For a high-quality product (e.g., with iron content < 1 mg/kg), cladding (rubber or plastic coating) is required. At < 50 °C the solution can be transported by pipes of alkali-resistant steel or plastic (e.g., PVC). Iron pipes are always kept full to prevent corrosion due to ingress of air and consequent black coloration of the solution. At higher temperature, coated materials such as rubber-lined steel, austenitic Cr–Ni steel (e.g., DIN 1.4541), nickel, Hypalon, epoxy resin, polypropylene, or glass fiber-reinforced composites are suitable. In the latter case, an inner lining must be used to prevent contact between the glass fiber and the solution. Heat exchangers are usually constructed

of nickel, nickel alloys, or stainless steel because of the high temperature. For equipment handling highly concentrated solutions, nickel is the most commonly used material because of its outstanding corrosion resistance. Metals that have been in contact with solutions are difficult to weld, so that repairs to pipework and equipment which have carried sodium hydroxide solutions are difficult. A comprehensive review of materials that can be used with sodium hydroxide is given in [189].

Pipelines carrying 50% sodium hydroxide solution in cold regions are provided with thermostatic heating. Solutions are transported by road, rail tanker, or ship.

Caustic soda prills are stored in steel or stainless steel hoppers with a capacity of 30–50 m<sup>3</sup>. The hoppers have conical bases with an angle of 25° to the vertical and are provided with external hammering equipment. Even when the product is stored under dry air, a storage time of 3–6 d should not be exceeded to ensure that the prills do not cake under their own weight. Solid sodium hydroxide is usually packed in 25–50-kg hermetically sealed polyethylene sacks. For transport, the sacks are stacked on wooden palettes and shrink wrapped in polyethylene. Caustic soda prills are also carried in 50- or 200-kg steel drums, loose in 1000-kg-capacity steel or flexible containers, or in transportable hoppers. In the closed system delivery (CSD) method of the PPG Company, containers coated with epoxy resin are transported by road and rail. Pneumatic transport is carried out with dry air and causes very little damage to the product [190].

### 51.14.3 Uses

Most users of sodium hydroxide require dilute aqueous solutions.

The sodium hydroxide produced in Europe (8.67 × 10<sup>6</sup> t/a NaOH) in 1990 was divided among various areas of use as shown in Figure 51.26. More than 48% of production is used in the chemical industry:

- In inorganic chemistry, sodium hydroxide is used in the manufacture of sodium salts,



for alkaline ore digestion, and for pH regulation.

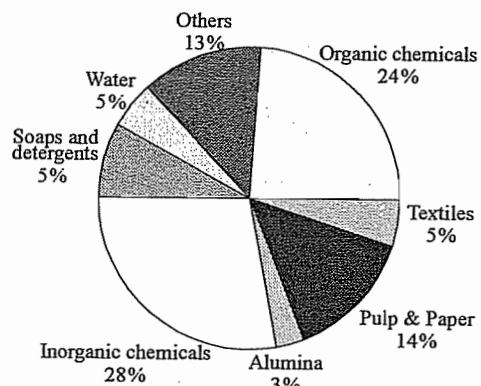

Figure 51.26: Consumption of sodium hydroxide in Europe (total:  $40.96 \times 10^6$  t/a in 1995).

- The organic chemical industry uses sodium hydroxide for saponification reactions, production of nucleophilic anionic intermediates, etherification and esterification, basic catalysis, and the production of free organic bases. Sodium hydroxide solution is used for scrubbing waste gases and neutralizing wastewater.
- In the paper industry, sodium hydroxide solution is used for cooking wood (removal of lignin).
- The textile industry uses sodium hydroxide solution to manufacture viscose and viscose staple fibers. The sodium hydroxide solution used must contain only traces of chloride ions (rayon quality). The surface of cotton can be improved by treatment with sodium hydroxide solution (mercerization).
- Considerable quantities of sodium hydroxide are used for sodium phosphate production in the detergent industry. Soaps are manufactured by the saponification of fats and oils with sodium hydroxide solution, and detergents are produced from organic sulfonic acids and sodium hydroxide.
- In the aluminum industry, sodium hydroxide is used mainly for the treatment of bauxite.
- Waterworks use dilute sodium hydroxide solution to regenerate ion exchangers for

water purification and wastewater treatment.

- Other users of sodium hydroxide include electroplating technology, the natural gas and petroleum industries, the glass and steel industries, and gold extraction (cyanide leaching). In the food industry, sodium hydroxide is used for degreasing, cleaning, and for peeling potatoes.

#### 51.14.4 Safety Precautions

Because of its strongly caustic action, all contact with sodium hydroxide during handling must be prevented by the use of suitable protective equipment (protective goggles, safety gloves, and, if needed, dust masks). Any clothing or shoes that come in contact with sodium hydroxide must be removed immediately and can be reused only after thorough cleaning. First aid to affected parts of the body consists of washing with copious amounts of water. The skin can be neutralized with a dilute solution of a buffered weak acid (e.g., acetic acid–sodium acetate). For irrigation of the eyes, a special hygienic eyewash solution is used. The product poses no direct environmental risk and has therefore been removed from the list of chemicals (e.g., in the United States) whose emission must be reported to local and national environmental authorities.

#### 51.14.5 Economic Aspects

Methods of manufacture of sodium hydroxide have changed often throughout the years (see also [191]). Decisive factors have included the availability of raw materials (sodium carbonate, sodium chloride, or sodium sulfate), process economics, and product quality. The coproduction of chlorine in the electrolytic process and of sulfuric acid in the electrolysis process together with their environmental implications may also have an effect on future production of sodium hydroxide solution.

Total world production in 1995 was  $40.96 \times 10^6$  t/a NaOH, the largest amount being pro-

duced in the United States (Figure 51.27). Production of chlorine and alkali since 1920 in the United States is shown in Figure 51.28. Growth was almost exponential until 1965, after which it flattened out considerably during the next 20 years. As shown in Figure 51.29, world production increased by 40% from 1976 to 1995, while the corresponding increase during the same period in the United States was only ca. 26%, and in Germany only 13%. An annual growth of 2–2.2% as can be seen starting from 1992–1993 is forecast up to 2000, with the greatest increase in Asia–Pacific region [192, 193], especially in China and in countries with low energy price. By that time, world consumption will probably be ca.  $43 \times 10^6$  t/a NaOH and world capacity ca.  $50 \times 10^6$  t/a [190]. Because the growth rate of the coproduct chlorine is estimated to be in the same range, or even higher, a world shortfall of electrolytic sodium hydroxide solution is not expected until the year 2000 [175].

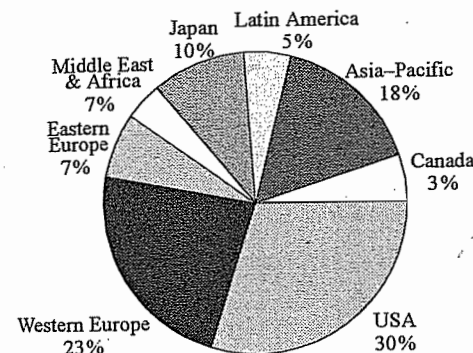

Figure 51.27: World production of sodium hydroxide by region (total:  $38.43 \times 10^6$  t/a in 1990).

The conversion of sodium carbonate to sodium hydroxide by causticization has been revived since 1990, but the possibilities for producing sodium hydroxide solution from natural sodium carbonate are limited by the rather high transport costs, because natural deposits of sodium carbonate are much rarer than those of sodium chloride. At present, the process is used only in the United States. Synthetic sodium carbonate produced by the Solvay process has the disadvantage that the wastewater contains chloride.

Supply–demand restructuring and a technical breakthrough for alternative techniques such as salt splitting forced by increasing prices have not taken place so far and cannot be seen coming.

Increasing prices could lead to supply–demand restructuring and to a technical breakthrough for alternative techniques such as salt splitting.

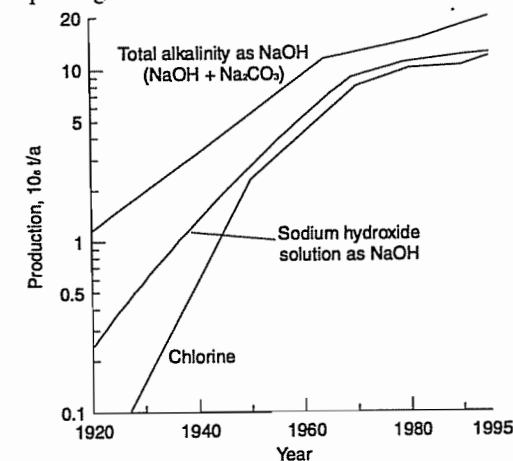

Figure 51.28: U.S. production of chlorine, sodium hydroxide solution, and total alkali.

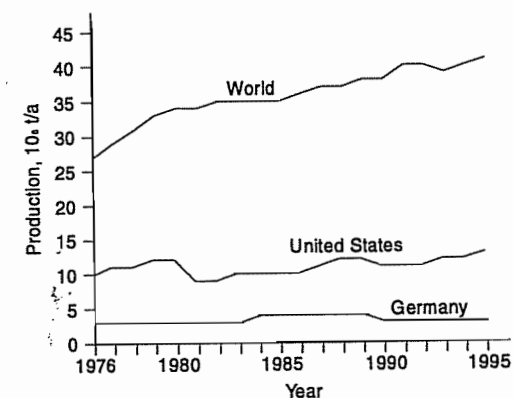

Figure 51.29: Growth of sodium hydroxide production in West Germany, the United States, and the world from 1976 to 1995.

## 51.15 Sodium Carbonates

### 51.15.1 Sodium Carbonate

Sodium carbonate (soda ash) is the neutral sodium salt of carbonic acid. It is one of the most important raw materials used in the chemical industry, and has been known by humans since ancient times. Sodium carbonate had many uses even then (cleaning and glass manufacture) for which it is still indispensable. Sodium carbonate from the deposits in Wadi Natrun (4%  $\text{Na}_2\text{CO}_3$ , 25%  $\text{NaHCO}_3$ ) was traded in ancient Egypt.

Production of the alkaline materials sodium carbonate and potassium carbonate (which were recognized rather late as chemically distinct) was carried out from ancient times until the 1800s by the combustion of marine and land vegetation, followed by calcination at red heat and leaching of the ash. The term soda ash originates from this process.

The soda ash obtained in this way was a low-percentage material; e.g., Spanish barilla contained 25–30%  $\text{Na}_2\text{CO}_3$ , varec from Normandy 3–8%, and Scottish kelp 10–15%. The soda ash produced from plants was very expensive, and the processes used were too primitive for mass production and consumed vast quantities of vegetation.

Large-scale production was possible only after the development of a new process, named after its inventor **LEBLANC** (1742–1806). In 1790, the first plant was built in Saint-Denis, France. Initially, production was 300 kg/d. In the following years, the soda industry developed rapidly in England due to the increasing demand for soda ash to clean cotton from the colonies. In 1878, production in England was 8 t per week, and in the rest of the world, 4 t a week.

However, in the second half of the 1800s, the Leblanc soda ash process experienced serious competition from the Solvay process. In

the first half of the 1800s, investigations were already being carried out into the industrial use of the double decomposition reaction of  $\text{NaCl}$  with  $\text{NH}_4\text{HCO}_3$ , but without success. However, the Belgian **ERNEST SOLVAY** (1838–1932) brought the development of the process to a successful conclusion during 1861–1865. The first plant was started up in Couillet, Belgium, with an initial production of 1.5 t/d. The first Solvay plant in Germany was built in 1880 in Wyhlen on the upper Rhine.

The technically and economically superior Solvay process displaced the Leblanc to such an extent that by the early 1900s only a few Leblanc plants were in production. The last Leblanc works ceased operation around 1923. Since then, the Solvay process has remained predominant. Since World War II, soda ash has been increasingly obtained from trona, especially in the United States.

#### 51.15.1.1 Properties

**Physical Properties.** In addition to anhydrous sodium carbonate,  $\text{Na}_2\text{CO}_3$ , the following hydrates exist: sodium carbonate monohydrate,  $\text{Na}_2\text{CO}_3 \cdot \text{H}_2\text{O}$ ; sodium carbonate heptahydrate,  $\text{Na}_2\text{CO}_3 \cdot 7\text{H}_2\text{O}$ ; and sodium carbonate decahydrate,  $\text{Na}_2\text{CO}_3 \cdot 10\text{H}_2\text{O}$ . The physical properties of these compounds are listed in Table 51.15. Solubilities of the hydrates of sodium carbonate are shown in Figure 51.30. The relationship between the concentration of an aqueous solution of  $\text{Na}_2\text{CO}_3$  and its pH at 25 °C is shown in Figure 51.31.

**Chemical Properties. Thermal Behavior:** The thermal decomposition of sodium carbonate to sodium oxide and carbon dioxide in a vacuum in the absence of chemically activating substances such as water vapor begins at ca. 1000 °C. The dissociation pressure is ca. 200 Pa and increases to 10.3 kPa at 1450 °C [196].

Table 51.15: Physical properties of sodium carbonate and its hydrates.

|   | Anhydrous                | Monohydrate                                       | Heptahydrate                                       | Decahydrate   |
|---|--------------------------|---|--|---|
| Formula   | $\text{Na}_2\text{CO}_3$ | $\text{Na}_2\text{CO}_3 \cdot \text{H}_2\text{O}$ | $\text{Na}_2\text{CO}_3 \cdot 7\text{H}_2\text{O}$ | $\text{Na}_2\text{CO}_3 \cdot 10\text{H}_2\text{O}$ |
| Density at 20 °C, g/cm <sup>3</sup>                                 | 2.533                    | 2.25  | 1.51   | 1.469   |
| Melting point, °C   | 851                      | 105 <sup>a</sup>                                  | 35.37 <sup>b</sup>                                 | 32.0  |
| Heat of fusion, J/g   |                          | 316   |  |   |
| Specific heat capacity at 25 °C, J·g <sup>-1</sup> ·K <sup>-1</sup> | 1.043                    | 1.265   | 1.864  | 1.877   |
| Heat of formation, J/g  | 10.676                   |   |  |   |
| Heat of hydration, J/g  |                          | 133.14  | 646.02   | 858.3   |
| Crystal structure   | monoclinic               | rhombic   | rhombic-bipyramidal                                | monoclinic-pseudo-hexagonal                         |
| Refractive indices $n_\alpha$ , $n_\beta$ , $n_\gamma$              | 1.410, 1.537, 1.544      | 1.420, 1.506, 1.524                               |  | 1.405, 1.425, 1.440                                 |
| Heat of solution <sup>c</sup> , J/g                                 | -222                     | -79.6   | 197  | 243   |

<sup>a</sup>In its own water of crystallization.

<sup>b</sup>Incongruent.

<sup>c</sup>Integrated enthalpy of solution at infinite dilution.

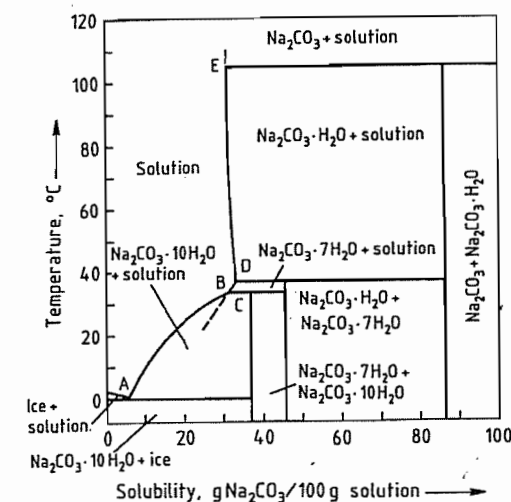
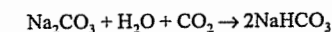

Figure 51.30: Solubilities in the system  $\text{Na}_2\text{CO}_3\text{--H}_2\text{O}$  [194]. Temperatures and concentrations of the two-salt points and the cryohydric point.

| Two-salt point | T, °C   | Solubility, g $\text{Na}_2\text{CO}_3$ /100 g solution | Solid phases   |
|----------------|---------|--|--|
| A              | -2.1    | 5.93   | ice + $\text{Na}_2\text{CO}_3 \cdot 10\text{H}_2\text{O}$  |
| B              | 32.0    | 31.26  | $\text{Na}_2\text{CO}_3 \cdot 10\text{H}_2\text{O}$ + $\text{Na}_2\text{CO}_3 \cdot 7\text{H}_2\text{O}$             |
| C              | 32.96   | 33.35  | $\text{Na}_2\text{CO}_3 \cdot 10\text{H}_2\text{O}$ + $\text{Na}_2\text{CO}_3 \cdot \text{H}_2\text{O}$ (metastable) |
| D              | 35.37   | 33.21  | $\text{Na}_2\text{CO}_3 \cdot 7\text{H}_2\text{O}$ + $\text{Na}_2\text{CO}_3 \cdot \text{H}_2\text{O}$               |
| E              | 105 ± 5 | 31.15  | $\text{Na}_2\text{CO}_3 \cdot \text{H}_2\text{O}$ + $\text{Na}_2\text{CO}_3$   |

**Reaction with Water and Carbon Dioxide.** Sodium carbonate is hygroscopic. In air at 96% R.H. its weight can increase by 1.5%

within 30 min [197]. If sodium carbonate is stored under moist conditions, its alkalinity decreases due to absorption of moisture and carbon dioxide from the atmosphere



Water vapor reacts with sodium carbonate above ca. 400 °C to form sodium hydroxide and carbon dioxide [198].

**Reaction with Elements.** Sodium carbonate reacts exothermically with chlorine above ca. 150 °C to form  $\text{NaCl}$ ,  $\text{CO}_2$ ,  $\text{O}_2$  and  $\text{NaClO}_4$  [199].

The elements platinum, gold, vanadium, titanium, zirconium, aluminum, molybdenum, tungsten, and iron (1200 °C) are attacked by fused  $\text{Na}_2\text{CO}_3$ , with liberation of  $\text{CO}_2$  and formation of complex metal oxide sodium oxide compounds. At higher temperature, the  $\text{Na}_2\text{O}$  formed reacts with excess metal to form sodium metal vapor [200]. Sodium carbonate reacts very slowly with copper and nickel at high temperature (> 1500 °C).

#### 51.15.1.2 Sodium Carbonate Minerals

Whereas the production of sodium carbonate from the ashes of plants that grow in salty soil near the sea is only of historical interest, extraction from soda-containing minerals, especially trona, is of increasing importance.

The most important deposits are located in Wyoming (Green River District), California (Owens Lake and Searles Lake), East Africa

(Magadi Lake), and Lower Egypt (Wadi Natrun).

The proportion of  $\text{Na}_2\text{CO}_3$  in the salt mixture in such deposits seldom exceeds 40%. The accompanying compounds include sodium hydrogencarbonate, borax, sodium sulfate, sodium chloride, and potassium chloride.

For example, the concentrations of dissolved salts in the water of Owens Lake are [201]

|                             |                                      |          |
|-----------------------------|--------------------------------------|----------|
| 9% $\text{Na}_2\text{CO}_3$ | 1% $\text{Na}_2\text{B}_4\text{O}_7$ | 16% NaCl |
| 1.2% $\text{NaHCO}_3$       | 3% $\text{Na}_2\text{SO}_4$          | 1.5% KCl |

Deposits of  $\text{Na}_2\text{CO}_3$ -containing minerals occur worldwide:

|                |  |
|----------------|--|
| Trona          | $\text{Na}_2\text{CO}_3 \cdot \text{NaHCO}_3 \cdot 2\text{H}_2\text{O}$  |
| Natron         | $\text{Na}_2\text{CO}_3 \cdot 10\text{H}_2\text{O}$                      |
| Thermonantrite | $\text{Na}_2\text{CO}_3 \cdot \text{H}_2\text{O}$                        |
| Hanksite       | $2\text{Na}_2\text{CO}_3 \cdot 9\text{Na}_2\text{SO}_4 \cdot \text{KCl}$ |
| Pirssonite     | $\text{Na}_2\text{CO}_3 \cdot \text{CaCO}_3 \cdot 2\text{H}_2\text{O}$   |
| Gaylussite     | $\text{Na}_2\text{CO}_3 \cdot \text{CaCO}_3 \cdot 5\text{H}_2\text{O}$   |

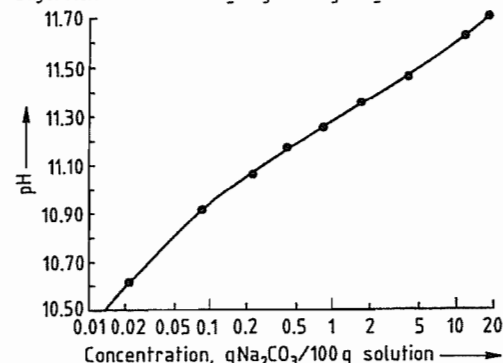

Figure 51.31: pH values of aqueous solutions of  $\text{Na}_2\text{CO}_3$  at 25 °C [195].

| Concentration, g $\text{Na}_2\text{CO}_3$ /100 g solution | pH at 25 °C |
|---|-------------|
| 0.055   | 10.274      |
| 0.0217  | 10.612      |
| 0.0884  | 10.919      |
| 0.2246  | 11.063      |
| 0.4376  | 11.171      |
| 0.8609  | 11.254      |
| 1.806   | 11.357      |
| 4.241   | 11.453      |
| 12.034  | 11.617      |
| 18.555  | 11.699      |

Only trona is of commercial importance. These  $\text{Na}_2\text{CO}_3$ -containing minerals were formed from the original rock by the erosive action of air, water, heat, and pressure, followed by chemical changes caused by the ac-

tion of atmospheric carbon dioxide. The carbonate-containing salts formed were leached by water and then concentrated and crystallized by evaporation.

### 51.15.1.3 Production

#### Ammonia-Soda Process

##### General and Theoretical Principles

The ammonia-soda process is based on the formation of sparingly soluble sodium hydrogencarbonate (known in the soda industry as bicarbonate) by reacting sodium chloride with ammonium hydrogencarbonate in aqueous solution:

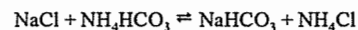

The process includes the following stages:

1. Production of a saturated salt solution  
 $\text{NaCl} + \text{H}_2\text{O}$
2. Burning of limestone or chalk (the  $\text{CO}_2$  liberated is used in stage 4)  
 $\text{CaCO}_3 \rightarrow \text{CaO} + \text{CO}_2$
3. Saturation of the salt solution with ammonia  
 $\text{NaCl} + \text{H}_2\text{O} + \text{NH}_3$
4. Precipitation of bicarbonate by the introduction of carbon dioxide (from stages 2 and 6)  
 $\text{NaCl} + \text{H}_2\text{O} + \text{NH}_3 + \text{CO}_2 \rightarrow \text{NH}_4\text{Cl} + \text{NaHCO}_3$
5. Filtering and washing of precipitated bicarbonate  
 $2\text{NaHCO}_3 \rightarrow \text{Na}_2\text{CO}_3 + \text{H}_2\text{O} + \text{CO}_2$
6. Thermal decomposition of bicarbonate to sodium carbonate (the  $\text{CO}_2$  evolved is recycled to stage 4)  
 $\text{CaO} + \text{H}_2\text{O} \rightarrow \text{Ca(OH)}_2$
7. Production of milk of lime  
 $\text{CaO} + \text{H}_2\text{O} \rightarrow \text{Ca(OH)}_2$
8. Recovery of ammonia by distillation of the mother liquor from stage 4 (bicarbonate precipitation) with milk of lime (the ammonia liberated is recycled to stage 3)  
 $2\text{NH}_4\text{Cl} + \text{Ca(OH)}_2 \rightarrow 2\text{NH}_3 + \text{CaCl}_2 + 2\text{H}_2\text{O}$

Table 51.16: Reciprocal pair  $\text{NaCl} + \text{NH}_4\text{HCO}_3 \rightleftharpoons \text{NaHCO}_3 + \text{NH}_4\text{Cl}$  15 °C isotherm, monovariant points (mol/1000 g  $\text{H}_2\text{O}$ ).

| Point | NaCl | $\text{NaHCO}_3$ | $\text{NH}_4\text{Cl}$ | $\text{NH}_4\text{HCO}_3$ | Solid phase   |
|-------|------|------------------|------------------------|---------------------------|---|
| a     | 6.12 |                  |                        |                           | NaCl  |
| b     |      |                  | 6.64                   |                           | $\text{NH}_4\text{Cl}$  |
| c     |      |                  |                        | 2.36                      | $\text{NH}_4\text{HCO}_3$   |
| d     |      | 1.05             |                        |                           | $\text{NaHCO}_3$  |
| I     | 6.06 | 0.12             |                        |                           | $\text{NaCl} + \text{NaHCO}_3$                                    |
| II    | 4.55 |                  | 3.72                   |                           | $\text{NaCl} + \text{NH}_4\text{Cl}$                              |
| III   |      |                  | 6.40                   | 0.81                      | $\text{NH}_4\text{Cl} + \text{NH}_4\text{HCO}_3$                  |
| IV    |      | 0.71             |                        | 2.16                      | $\text{NaHCO}_3 + \text{NH}_4\text{HCO}_3$                        |
| $P_1$ | 0.51 | 0.93             | 6.28                   |                           | $\text{NH}_4\text{Cl} + \text{NH}_4\text{HCO}_3 + \text{NaHCO}_3$ |
| $P_2$ | 4.44 | 0.18             | 3.73                   |                           | $\text{NH}_4\text{Cl} + \text{NaCl} + \text{NaHCO}_3$             |

The liquid remaining after distillation is usually discarded in its entirety, because only a small fraction can be used for calcium chloride production, depending on demand.

The process can be represented by the following simplified equation:

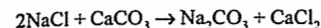

In aqueous solution, the reaction proceeds from right to left due to the low solubility of calcium carbonate. The role of ammonia is to promote the formation of sodium bicarbonate via the intermediate ammonium bicarbonate.

The reaction that takes place in aqueous solution

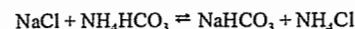

is determined by the solubilities of the individual salts in the presence of other components of the reciprocal salt pairs. These solubility relationships have been investigated by FEDOTIEFF [202].

The basic principles can be explained by using the 15 °C isotherm (Figure 51.32), based on the values given in Table 51.16. The figure is the orthogonal projection of a three-dimensional diagram (i.e., a four-sided pyramid whose edges represent the coordinates of  $\text{NaCl}$ ,  $\text{NH}_4\text{Cl}$ ,  $\text{NH}_4\text{HCO}_3$ , and  $\text{NaHCO}_3$ ). This diagram shows the ranges of existence of the individual solid phases that are in equilibrium with their saturated solutions at 15 °C:

|                                |                           |
|--------------------------------|---------------------------|
| Area a-I- $P_2$ -II:           | NaCl                      |
| Area II- $P_2$ - $P_1$ -III-b: | $\text{NH}_4\text{Cl}$    |
| Area $P_1$ -III-c-IV:          | $\text{NH}_4\text{HCO}_3$ |
| Area I- $P_2$ - $P_1$ -IV-d:   | $\text{NaHCO}_3$          |

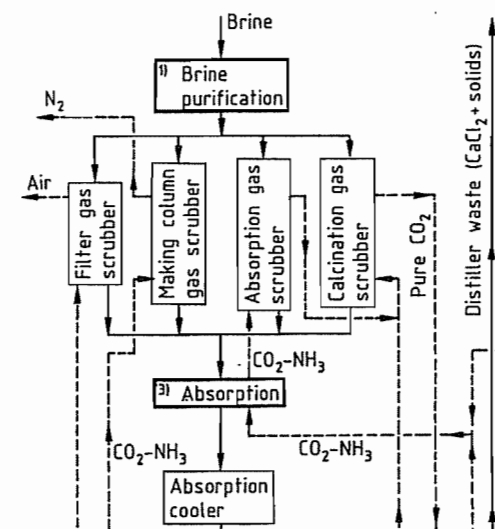
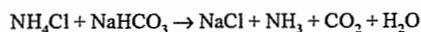

Figure 51.32: The 15 °C isotherm for the reciprocal salt pair  $\text{NaCl} + \text{NH}_4\text{HCO}_3$  (concentration in mol/1000 g  $\text{H}_2\text{O}$  are shown on the ordinate and abscissa).

Along the lines I- $P_2$ , II- $P_2$ ,  $P_2$ - $P_1$ ,  $P_1$ -III, and  $P_1$ -IV, two solid phases coexist, and at the points  $P_1$  and  $P_2$ , three solid phases coexist. These two points are thus monovariant because in the presence of three solid phases, a change in concentration is possible only by changing the temperature.

The point  $P_1$ , at which the three salts  $\text{NH}_4\text{Cl}$ ,  $\text{NH}_4\text{HCO}_3$ , and  $\text{NaHCO}_3$  coexist, is of special importance for the ammonia-soda process, because this point has the highest  $\text{NH}_4\text{Cl}$  concentration in the entire range. If point  $P_1$  is reached by the precipitation of bicarbonate, it represents the maximum attainable sodium yield. Nevertheless, working so that neither the point  $P_1$  nor the lines  $P_1$ - $P_2$  and  $P_1$ -IV are

actually reached is advisable, to avoid coprecipitation of  $\text{NaHCO}_3$ ,  $\text{NH}_4\text{Cl}$ , or  $\text{NH}_4\text{HCO}_3$ . The coprecipitation of  $\text{NH}_4\text{Cl}$  has a particularly detrimental effect on the quality of the soda, because it is converted to  $\text{NaCl}$  on calcination:



or

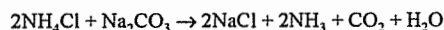

An end point that is as close as possible to  $P_1$  but lies within the hatched area in Figure 51.32 is best.

The course of bicarbonate precipitation can be followed clearly in the square diagram of JANECKE [203]. Figure 51.33 shows the 30 °C isotherm of the system in such a diagram. This diagram does not represent absolute solubilities, but percentages of salts in the total salt content of the solution. Thus, the corners represent pure salts or solutions of a single salt, and the lines joining two corners represent mixtures of two salts. Points within the square represent mixtures or solutions of three salts. The solubilities can be found from the diagram if the appropriate water value is given for each point of equilibrium (the salt value being 1 kmol in all cases). This can be shown by means of lines of equal water content (isohydric lines).

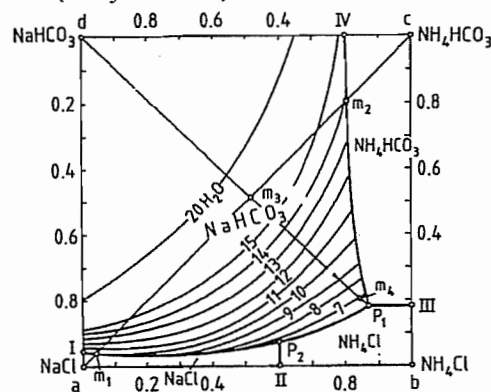

Figure 51.33: The 30 °C isotherm for the reciprocal salt pair  $\text{NaCl} + \text{NH}_4\text{HCO}_3$ . On the ordinate and abscissa of the square diagram, the amount of each salt is shown as a molar fraction of the total salt content of the solution.

The points, lines, and areas in Figure 51.33 have the same significance in principle as

those in the 15 °C isotherm diagram of Figure 51.32. The corner point (a) corresponds to a solution of pure sodium chloride. If  $\text{NH}_4\text{HCO}_3$  is added (by passing carbon dioxide and ammonia into the solution), the mixture moves from point (a) toward point (c) ( $\text{NH}_4\text{HCO}_3$ ). In the case of saturation, systems represented by points on line  $m_1$ – $m_2$  are in equilibrium with  $\text{NaHCO}_3$  as solid phase.

In the ammonia–soda process, point (a) represents a solution that is not completely saturated (9.7 instead of 9.01 kmol  $\text{H}_2\text{O}$ /kmol  $\text{NaCl}$ ). Point ( $m_3$ ) on line a–c is reached by the introduction of  $\text{CO}_2$  and  $\text{NH}_3$  in an equimolar ratio. At this point, the water content necessary to give a saturated solution is ca. 17.5 kmol/kmol dissolved salt (see isohydric lines in Figure 51.33). However, the proportion of water introduced with the brine, which is further reduced by the reaction of  $\text{NH}_3$  with  $\text{CO}_2$  to form  $\text{NH}_4\text{HCO}_3$ , is only ca. 7 kmol/kmol dissolved salt. This leads to the precipitation of sodium bicarbonate.

The precipitation process consists of separation of the supersaturated system ( $m_3$ ) into the solid pure component  $\text{NaHCO}_3$  (point d) and the saturated mother liquor ( $m_4$ ).

In the Solvay process the degrees of utilization of  $\text{Na}^+$  and  $\text{NH}_4^+$  are both important. These can be calculated from the composition of the mother liquor (determined by chemical analysis) by using the equations:

$$U_{\text{Na}^+} = \frac{100(\text{Cl}^- - \text{Na}^+)}{\text{Cl}^-}$$

$$U_{\text{NH}_4^+} = \frac{100(\text{NH}_4^+ - \text{HCO}_3^-)}{\text{NH}_4^+}$$

In these equations,  $\text{Cl}^-$ ,  $\text{Na}^+$ ,  $\text{NH}_4^+$ , and  $\text{HCO}_3^-$  denote the concentrations in moles per kilogram of  $\text{H}_2\text{O}$ , and  $U_{\text{Na}^+}$  and  $U_{\text{NH}_4^+}$  denote the percentage utilization of  $\text{Na}^+$  and  $\text{NH}_4^+$ . The values for  $U_{\text{Na}^+}$  and  $U_{\text{NH}_4^+}$  depend on the starting concentrations, and maximum  $\text{Na}^+$  utilization does not correspond to maximum  $\text{NH}_4^+$  utilization. These relationships are illustrated by the values given in Table 51.17.

Table 51.17: Percentage utilization of  $\text{Na}^+$  and  $\text{NH}_4^+$  in the reaction of  $\text{NaCl}$  with  $\text{NH}_4\text{HCO}_3$  at 15 °C and various initial concentrations.

| Initial concentration of solution, mol/1000 g $\text{H}_2\text{O}$ |                           | Point | Solution produced, gmol/1000 g $\text{H}_2\text{O}$ |               |               |                 | Utilization, % |                 |
|--|---------------------------|-------|---|---------------|---------------|-----------------|----------------|-----------------|
| $\text{NaCl}$  | $\text{NH}_4\text{HCO}_3$ |       | $\text{HCO}_3^-$                                    | $\text{Cl}^-$ | $\text{Na}^+$ | $\text{NH}_4^+$ | $\text{Na}^+$  | $\text{NH}_4^+$ |
| 8.188  | 3.730                     | $P_2$ | 0.18  | 8.188         | 4.62          | 3.730           | 43.58          | 95.17           |
| 7.658  | 4.552                     | ↓     | 0.31  | 7.658         | 3.39          | 4.552           | 55.73          | 93.19           |
| 7.128  | 5.450                     |       | 0.51  | 7.128         | 2.19          | 5.450           | 69.28          | 90.64           |
| 6.786  | 6.272                     | $P_1$ | 0.92  | 6.786         | 1.44          | 6.272           | 78.78          | 85.33           |
| 6.000  | 5.640                     |       | 0.99  | 6.000         | 1.34          | 5.640           | 77.67          | 82.45           |
| 5.403  | 5.210                     | ↓     | 1.07  | 5.403         | 1.27          | 5.210           | 76.49          | 79.46           |
| 5.025  | 4.919                     |       | 1.12  | 5.025         | 1.23          | 4.919           | 75.52          | 77.23           |
| 4.000  | 4.135                     | IV    | 1.30  | 4.000         | 1.16          | 4.135           | 71.00          | 68.56           |

For economic operation of the process, the utilization of  $\text{Na}^+$  should be high, rather than that of  $\text{NH}_4^+$ , since unconsumed  $\text{NH}_4^+$  is recycled. Therefore, in practice,  $\text{Na}^+$  utilization is between 72 and 76%, and  $\text{NH}_4^+$  between 69 and 71%. However, note that consideration of phase rule theory gives no information about kinetic effects such as rates of reaction, nucleation, and crystallization.

A comprehensive treatment of the phase rule theory is given in [204, pp. 125–160].

## Technology

The Solvay ammonia–soda process is shown schematically in Figure 51.34. The main operational stages are shown in the numbered bold rectangle:

**Stage 1: Brine Purification.** The sodium chloride used as a raw material in the Solvay process can be obtained by conventional or solution mining [205].

The brine always contains inorganic impurities that lead to production problems and impair the quality of the final product. For example, calcium and magnesium ions can cause scaling in the equipment and pipework due to the formation of basic carbonates during ammonia absorption, which can seriously interfere with the process. Purification of the brine, which should be as near saturation as possible to achieve optimum  $\text{Na}^+$  utilization, is best carried out by the lime–soda process. Magnesium ions are precipitated as hydroxide, and calcium ions as carbonate:

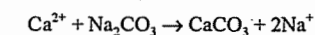
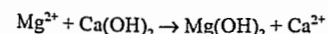

The reagents used in this precipitation are prepared by dissolving soda ash or milk of lime in brine ( $\text{Na}_2\text{CO}_3$  concentration: 65–80  $\text{kg}/\text{m}^3$ ;  $\text{Ca}(\text{OH})_2$  concentration: 170–185  $\text{kg}/\text{m}^3$ ). Reaction times, crystallization rates, and settling rates are improved if the brine with the added reagent solutions is mixed with a recycled seed slurry. Under these conditions, precipitates of calcium carbonate and magnesium hydroxide can be produced with settling rates up to 1 m/h, and in some cases even 3 m/h.

**Stage 2: Limestone Calcination and Lime Slaking.** The limestone must be of very high purity ( $\text{SiO}_2$ : < 3%;  $\text{Fe}_2\text{O}_3$ – $\text{Al}_2\text{O}_3$ : < 1.5%). From it, both carbon dioxide for the carbonation stage and calcium oxide for the distillative recovery of ammonia are produced by calcination with coke (see Section 56.5).

The quantity of limestone used per tonne of soda ash produced is determined solely by the amount of calcium oxide required for ammonia recovery. Hence, the excess carbon dioxide is either released to the atmosphere or supplied to other consumers.

The consumption of 95% pure limestone varies between ca. 1100 and 1200  $\text{kg}/1000$   $\text{kg}$  sodium carbonate, and is therefore approximately 10–20% higher than the theoretical value.

In the system  $\text{CaCO}_3 \rightleftharpoons \text{CaO} + \text{CO}_2$ , the equilibrium pressure of  $\text{CO}_2$ ,  $p_{\text{CO}_2}$ , varies logarithmically with absolute temperature  $T$

$$\log p_{\text{CO}_2}(\text{bar}) = -\frac{8580}{T(\text{K})} + 7.26$$

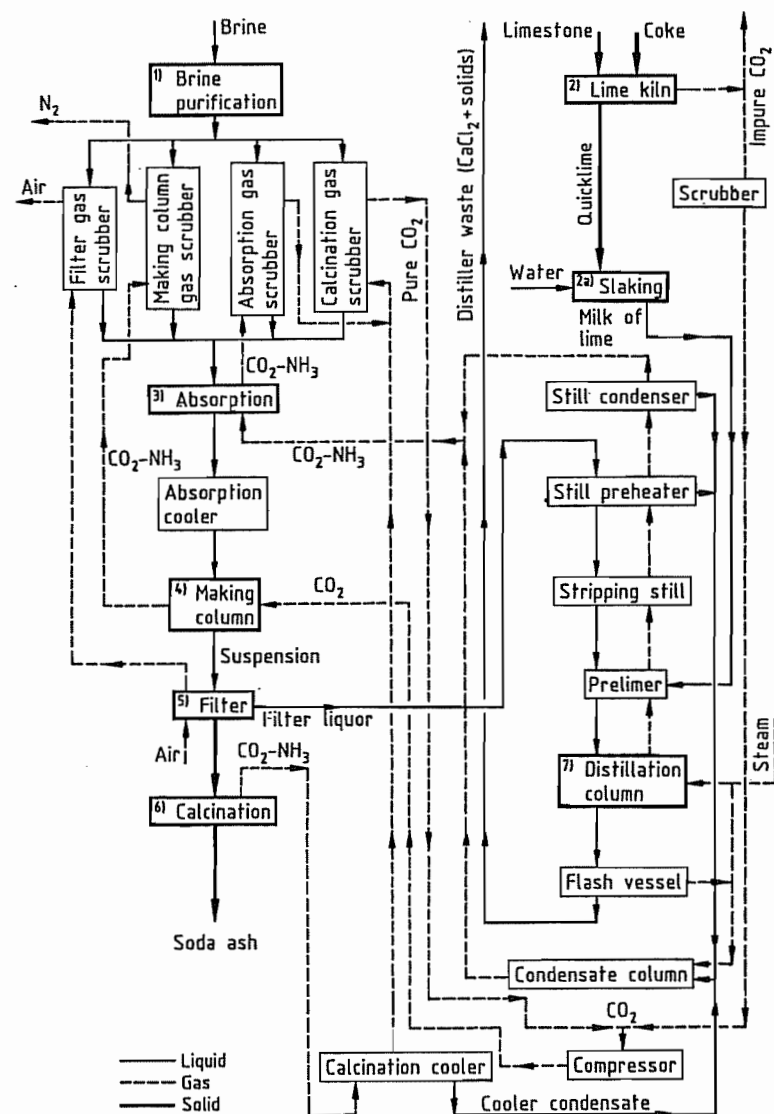

Figure 51.34: Flow sheet of the ammonia-soda process.

Thus the  $\text{CO}_2$  vapor pressure at ca.  $900^\circ\text{C}$  is 0.1 MPa. However, at this temperature, decomposition is too slow. If the rate of decomposition is increased by increasing the temperature dead-burnt limestone may be produced, which does not react with water. The best calcination temperature, therefore, lies between  $1050$  and  $1100^\circ\text{C}$ .

In soda ash plants, calcination is carried out in well-insulated shaft furnaces heated with coke [204, pp. 76–83]. Furnace gas  $\text{CO}_2$  contents of 40–42 vol% can be obtained. If liquid or gaseous fuels are used, the  $\text{CO}_2$  content of the gas is lower.

The hot, dust-laden gas is cooled and washed by direct contact with water. It then

passes to the  $\text{CO}_2$  compressors from which it is delivered to the carbonation stage.

Quicklime from the kiln is reacted with used cooling water ( $50\text{--}65^\circ\text{C}$ ) in horizontal rotating drums to produce a suspension of  $\text{Ca}(\text{OH})_2$  in water (milk of lime) that is as concentrated as possible. In favorable circumstances, the  $\text{CaO}$  content of the milk of lime can reach  $5.5\text{ mol/L}$ .

Before milk of lime is used in the distillative recovery of ammonia, coarse sand and unburnt limestone are removed by sieves, mixed with new limestone, and recycled to the kiln.

**Stage 3: Ammonia Absorption.** Gas from the distillation stage (stage 7) contains  $\text{NH}_3$  and  $\text{CO}_2$ , and is saturated with water vapor. In the absorption stage, this gas is absorbed by purified brine. Here, the total amount of ammonia required in the process and ca. 20% of the required carbon dioxide are added. The ammoniacal brine obtained contains ca.  $85\text{--}90\text{ kg/m}^3\text{ NH}_3$  and  $40\text{--}50\text{ kg/m}^3\text{ CO}_2$ . The  $\text{NaCl}$  content is reduced from ca.  $300\text{--}260\text{ g/L}$  due to the increase in the specific volume of the liquor caused by the addition of ammonia and by dilution with water.

The reactions that occur during absorption are strongly exothermic and can be represented by the following equations:

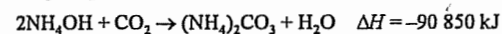
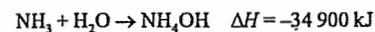

The absorption towers are equipped with effective internal or external coolers to remove the heat of reaction and the sensible heat of the distillation gas (total: ca.  $1.84\text{ GJ/t}$  sodium carbonate). A typical absorption plant consists of a tower containing eight bubble trays and an external intermediate cooler (Figure 51.35).

**Stage 4: Precipitation of Bicarbonate (Making).** The precipitation of sodium bicarbonate  $\text{NaCl} + \text{NH}_4\text{HCO}_3 \rightarrow \text{NaHCO}_3 + \text{NH}_4\text{Cl}$

is an exothermic process in which ammoniacal brine from the absorption stage is reacted with carbon dioxide from the lime kiln (stage 2) or from the calcination stage (stage 6). In most ammonia-soda plants, cast iron columns of the type shown in Figure 51.36 are used for

this reaction. In this double-tray column, which is equipped with tubular coolers in the lower part, ammoniacal brine is carbonated in countercurrent flow. The cooling water, also in countercurrent flow, must remove ca.  $1.42\text{ GJ/t}$  of heat.

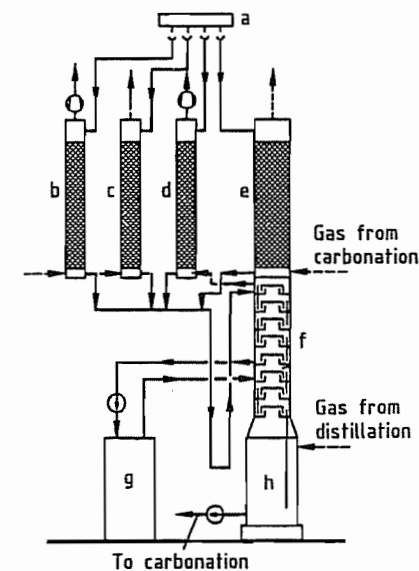

Figure 51.35: Absorption equipment with gas scrubbers: a) Brine distributor; b) Calcination gas scrubber; c) Filter gas scrubber; d) Absorption gas scrubber; e) Making column scrubber; f) Absorption; g) Absorption cooler; h) Reservoir.

Making columns become coated with the precipitated bicarbonate, which covers the inner parts including the cooling tubes, and must therefore be cleaned after 3–4 d of operation. This is carried out by washing with fresh ammoniacal brine while a stream of carbon dioxide gas is bubbled through (precarbonation). The washing liquor is then fed in parallel to the remaining columns, where it is carbonated in two stages. In the upper part of the columns (above the tube bundles), so-called weak gas (lime kiln gas) is used for carbonation, whereas in the lower part, more highly concentrated strong gas—a mixture of kiln gas and calcination gas—is used.

A distribution system for the liquid and gas streams enables each column to be used for either cleaning or making. In general, one out of four or five columns is a cleaning column.

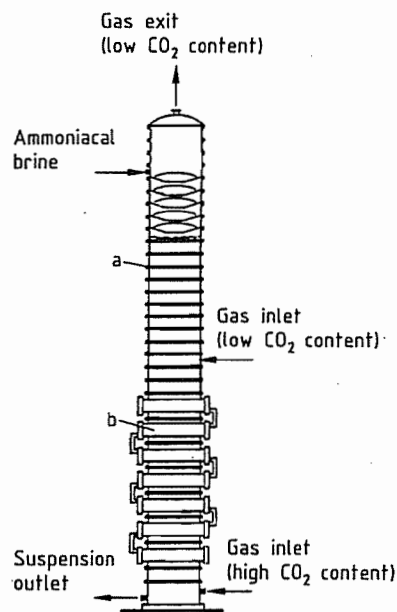

Figure 51.36: Making column: a) Double tray; b) Cooling tube bundle.

A few soda ash plants still use the Honigmann process, in which carbonation is carried out in three to five vessels.  $\text{CO}_2$ -containing gas is bubbled through a central dip tube into the ammoniacal brine. Gas with the highest  $\text{CO}_2$  content (calcination gas) is supplied to the vessel with the most strongly carbonated ammoniacal brine, and weak gas is fed to the vessel that contains fresh solution.

The temperature profile in both column and vessel processes exhibits a maximum of  $5060^\circ\text{C}$ . The suspension of bicarbonate in mother liquor leaves the carbonation stage at  $30^\circ\text{C}$ .

**Stage 5: Filtration of Bicarbonate.** Bicarbonate is generally separated from the mother liquor in continuous rotary vacuum filters or band filters, and sometimes in centrifuges. Mother liquor adhering to the bicarbonate crystals is washed off with condensate produced during the production process or with softened water. The quantity of washing water required depends on the particle size of the precipitated product and varies between 0.3 and  $1\text{ m}^3/\text{t}$  of bicarbonate.

Crude bicarbonate has the following approximate composition:  $\text{NaHCO}_3$ , 75.6%;  $\text{Na}_2\text{CO}_3$ , 6.9%;  $\text{NH}_4\text{HCO}_3$ , 3.4%;  $\text{NaCl} + \text{NH}_4\text{Cl}$ , 0.4%;  $\text{H}_2\text{O}$ , 13.7%.

Centrifuged products contain only 7–9% water. Calcination of 1 t of crude bicarbonate yields ca. 520–560 kg of soda ash.

**Stage 6: Calcination of Bicarbonate.** Thermal decomposition of crude bicarbonate to carbonate liberates carbon dioxide, ammonia, and water vapor. The product is technical-grade soda ash, which contains sodium chloride. The main reaction is

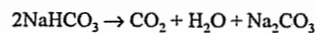

and side reactions are

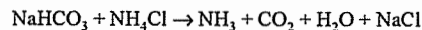
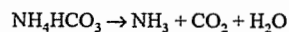

The heat requirement for the calcination of crude bicarbonate is  $0.92\text{ GJ/t}$  soda, not including that required for drying the moist, filtered product. The total heat requirement for calcination in rotary calciners is  $3.7\text{ GJ/t}$  soda. This heat is supplied at ca.  $180^\circ\text{C}$ ; the decomposition temperature of  $\text{NaHCO}_3$  is  $87.7^\circ\text{C}$  at a total  $\text{CO}_2$ - $\text{H}_2\text{O}$  pressure of 0.1 MPa.

Today, calcination is almost always carried out in rotary calciners. These are heated either externally with oil, gas, or coal, or internally with steam, which passes through heating tubes in the calciner countercurrent to the flow of solid material. Condensing steam gives much better heat transfer than combustion gas, so that the output from steam-heated rotary calciners is considerably higher than that of calciners heated by combustion processes. The advantages of steam-heated calciners compared with those heated by combustion include the absence of thermal damage to the calciner, smaller space requirements and hence lower equipment costs, and ca. 15% less fuel consumption.

Gases extracted from the calciners contain  $\text{CO}_2$ ,  $\text{NH}_3$ ,  $\text{H}_2\text{O}$ , and some leakage air, together with large amounts of dust (sodium carbonate and bicarbonate), which is removed in cyclones or electrostatic filters. Before this gas is used in the carbonation stage, it is

cooled and washed with brine and water until it is free of ammonia. The condensate produced at this point is fed to the ammonia recovery stage.

If the soda ash is required in the form of solution or hydrated crystals, wet calcination can be used. This is carried out in a tower with steam in countercurrent flow. In this thermal decomposition, a sodium carbonate sodium bicarbonate equilibrium is established, which limits the yield to 85–88%.

**Stage 7: Recovery of Ammonia.** Ammonia, present in the filtrate as ammonium carbonate, hydrogencarbonate, sulfate, and chloride, is recovered by distillation followed by absorption. Both  $(\text{NH}_4)_2\text{CO}_3$  and  $\text{NH}_4\text{HCO}_3$  are completely decomposed at  $85$ – $90^\circ\text{C}$ , liberating all of the carbon dioxide and a small part of the ammonia from solution. Liberation of ammonia from  $\text{NH}_4\text{Cl}$  and  $(\text{NH}_4)_2\text{SO}_4$  requires reaction with milk of lime:

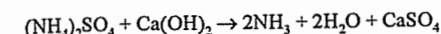
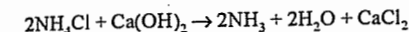

This reaction must be preceded by thermal decomposition of  $(\text{NH}_4)_2\text{CO}_3$  and  $\text{NH}_4\text{HCO}_3$  to avoid precipitation of calcium carbonate and consequent consumption of additional milk of lime. Free ammonia is displaced from solution with low-pressure steam.

A distillation plant is shown schematically in Figure 51.37. Distillation gas, which contains  $\text{NH}_3$  and  $\text{CO}_2$ , is cooled to ca.  $55$ – $60^\circ\text{C}$  in the still condenser and still preheater. At this temperature, no danger exists of blocking the pipework with crystallized salts formed by ammonia and carbon dioxide. The stripping still removes  $\text{CO}_2$  and  $\text{NH}_3$  by thermal decomposition of  $(\text{NH}_4)_2\text{CO}_3$  and  $\text{NH}_4\text{HCO}_3$ , and in the preliher,  $\text{NH}_4\text{Cl}$  and  $(\text{NH}_4)_2\text{SO}_4$  are reacted with milk of lime. In the distillation column the ammonia content of the liquor is lowered to ca.  $0.5\text{ kg/t}$  sodium carbonate by steam treatment. The  $\text{CO}_2$ - $\text{NH}_3$ -containing condensate from the gas cooler and heat exchanger is recycled to the stripping still or distilled in a special condensate tower.

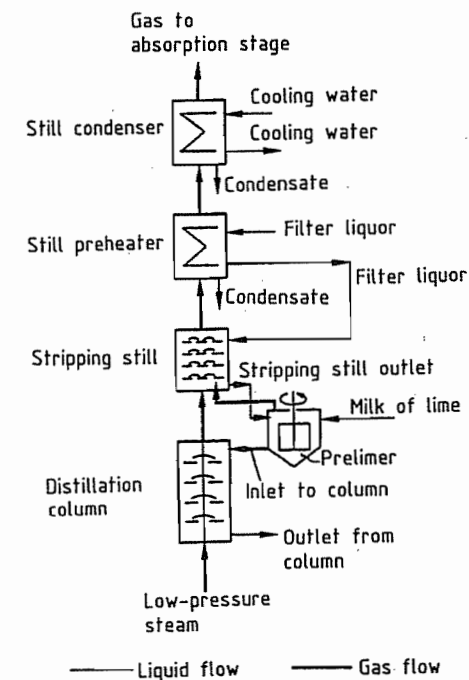

Figure 51.37: Flow diagram of stripping equipment.

### Modified Ammonia-Soda Process

Many variants of the ammonia-soda process exist [213]. Here, only the dual process, developed and operated in Japan, is described. This process combines soda ash production with ammonium chloride production. The importance of the process in Japan is due to the high cost of imported rock salt and use of the ammonium chloride as a fertilizer.

In the dual process [206] (Figure 51.38), ammonia is absorbed by the bicarbonate mother liquor, and solid sodium chloride is added. On cooling, ammonium chloride separates, is recovered in centrifuges, and is then dried in rotary dryers with air at  $150^\circ\text{C}$ . The mother liquor is recycled to the carbonation towers where sodium bicarbonate is precipitated.

Important differences exist between equipment used for the conventional Solvay process and that used for the ammonium chloride-soda process. In the dual process, ammonia is not recovered; hence no distillation equipment

is required. Also, lime kilns are not required if other sources of  $\text{CO}_2$  are available. Because of the extremely corrosive properties of  $\text{NH}_4\text{Cl}$ -containing solutions, they are produced in equipment made of special cast iron or plastics. As the mother liquor is recycled, special attention must be paid to the water balance of the system. The amount of water introduced into the system (e.g., for washing sodium bicarbonate and ammonium chloride) must be controlled continuously to maintain the correct quantity and composition. The quantity of sodium carbonate produced in 1970 by the dual process amounted to ca. 4.7% of world production [207].

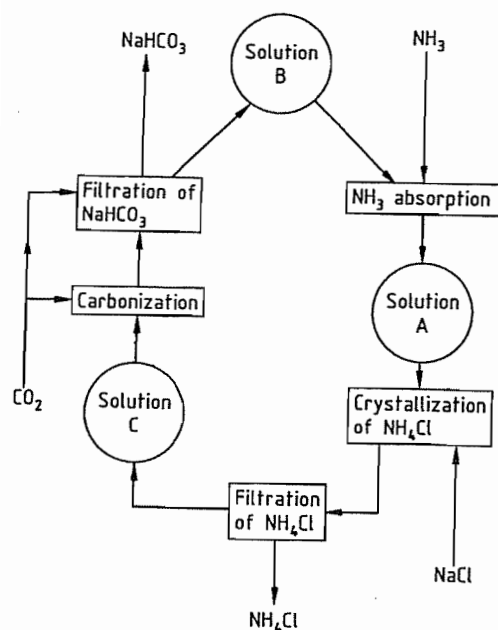

**Figure 51.38:** Flow diagram of the dual process. Solution A: 4.1 mol/L  $\text{NH}_4\text{Cl}$  + 1.05 mol/L  $\text{NaCl}$ ;  $\rho = 1.108 \text{ g/cm}^3$ ;  $t = 20^\circ\text{C}$ . Solution B: 3.45 mol/L  $\text{NH}_4\text{Cl}$  + 1.1 mol/L  $\text{NaCl}$ ;  $\rho = 1.110 \text{ g/cm}^3$ ;  $t = 5^\circ\text{C}$ . Solution C: 1.86 mol/L  $\text{NH}_4\text{Cl}$  + 3.73 mol/L  $\text{NaCl}$ ;  $\rho = 1.187 \text{ g/cm}^3$ ;  $t = 10^\circ\text{C}$ .

### Production from Trona and Other Sodium Carbonate-Containing Minerals

The production of soda ash from trona in the United States has become significant since

World War II. The raw material is either a naturally occurring brine containing sodium carbonate (e.g., from Searles Lake in California) or a trona deposit (e.g., from the Green River region of Wyoming).

Sodium carbonate brines are pumped from the lake and treated with  $\text{CO}_2$  gas to precipitate sodium bicarbonate, which is filtered, washed, and calcined to form sodium carbonate.

In another process, the liquor is evaporated in solar ponds until trona ( $\text{Na}_2\text{CO}_3 \cdot \text{NaHCO}_3 \cdot 2\text{H}_2\text{O}$ ) crystals separate. The trona contains ca. 45%  $\text{Na}_2\text{CO}_3$ , 35%  $\text{NaHCO}_3$ , 2%  $\text{NaCl}$ , 1.5%  $\text{Na}_2\text{SO}_4$ , 0.1%  $\text{SiO}_2$ , 0.2% insolubles, and 16%  $\text{H}_2\text{O}$ . Calcination yields a product containing 95–96% sodium carbonate.

In 1937, a large deposit of trona was discovered in the Green River region of Wyoming, but its significance was not recognized at first. Drilling work, which continued from 1944 to 1947, gave the first indication of the size of the deposit, which was subsequently extracted by the companies FMC, Stauffer Chemical, Allied Chemical, Texas Gulf (after 1976), and Tenneco Oil (after 1982) [208]. At first, mined trona (ca. 40 000 t/a) was simply calcined to produce crude sodium carbonate, but by 1952 an FMC plant was producing 300 000 t/a of purified sodium carbonate. Drilling work during the last 30 years has revealed reserves of  $> 50\,000 \times 10^6 \text{ t}$ , mainly at depths of 250–450 m.

Natural trona from these deposits is a colorless or white mineral with a density of 2.13  $\text{g/cm}^3$  and a Mohs hardness of 2.5–4. The deposits generally contain  $> 90\%$  trona, with halite ( $\text{NaCl}$ ), shortite ( $\text{Na}_2\text{CO}_3 \cdot 2\text{CaCO}_3$ ), pyrite ( $\text{FeS}_2$ ), shale, and other rock minerals. The United States now obtains its sodium carbonate entirely from trona; production capacity in 1991 was  $9.88 \times 10^6 \text{ t}$  [208].

Processing is carried out mainly by the monohydrate process (Figure 51.39). Trona is crushed to  $< 6 \text{ mm}$  and calcined at  $300^\circ\text{C}$  in a rotary furnace to remove water of crystallization and convert the bicarbonate to carbonate.

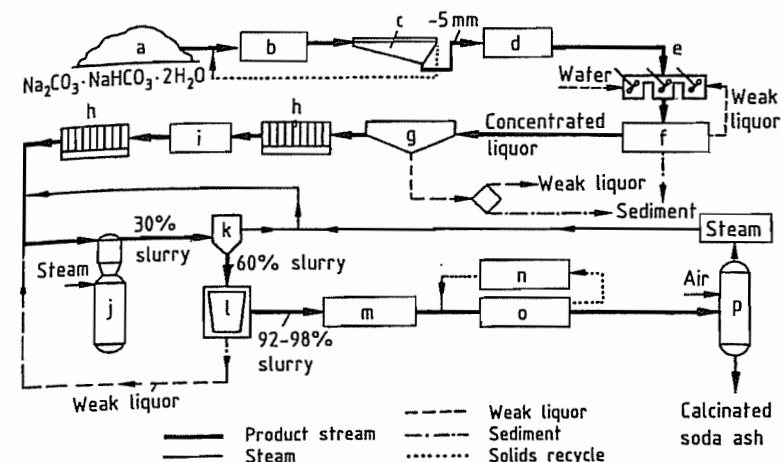

**Figure 51.39:** Conversion of trona to calcined soda ash (simplified flow diagram): a) Trona storage; b) Crusher; c) Screen; d) Rotary furnace; e) Agitated dissolver; f) Classifier; g) Thickener; h) Filter press; i) Activated carbon filter; j) Vacuum crystallizer; k) Cyclone; l) Centrifuge; m) Dryer; n) Grinding mill; o) Classifier; p) Product storage.

The calcined material is agitated with water to dissolve the crude soda ash. Insoluble components such as silica, sodium silicate, and gangue are removed by classifiers. The insoluble residues are then extracted with water. The concentrated liquor containing dissolved sodium carbonate is transferred to a thickener where the remaining finely divided insoluble residues are precipitated with flocculating agents. The clarified concentrated liquor is further purified by filter presses, and residual organic impurities are removed with activated carbon. The almost saturated solution is then evaporated in multiple-effect evaporators to give a 30% slurry of  $\text{Na}_2\text{CO}_3 \cdot \text{H}_2\text{O}$ . This is followed by concentration to a 60% solids content in hydrocyclones and centrifugation. The centrifuged monohydrate crystals, which still contain 2–8% water, are calcined in rotary furnaces, while the filtrate is recycled to the process. The calcined product is ground to the required particle size and then sent to the storage silo.

In the sodium sesquicarbonate process, trona is first subjected to a multistage solution process to remove impurities. After vacuum crystallization, the sesquicarbonate crystals produced are separated from the mother liquor by centrifugation and calcined in rotary furnaces.

The largest trona deposit outside the United States is located at Magadi Lake in Kenya. This has an area of 65  $\text{km}^2$  and a thickness of 30 m, and is extracted by open-cast mining. Since 1990, the production capacity of the Magadi-Soda Co. (a subsidiary of Penrice Soda Products of Australia) has been 275 000 t/a [208–211].

### Other Processes

**Le Blanc Process.** The Le Blanc process, which is now of only historical interest, is based on the following reactions:

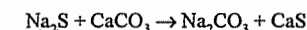
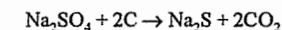
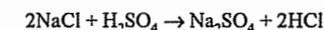

The first plant using this process began operating in 1790 with a production of 300 t/d. By 1870, England had 40 factories and Germany 20. From 1885, Leblanc soda ash production declined because of competition from the more economical Solvay process, which also resulted in a higher-quality product. In England, the United Alkali Co. ceased production by the Leblanc process in 1916, and in Germany, Chemische Fabrik Rhenania in Stolberg, the last company using the process, operated until 1923.

A major disadvantage of the Leblanc process compared to the Solvay process is that it involves mainly solid-phase reactions and consumes large amounts of energy (at red heat or just below). The waste products calcium sulfide and hydrochloric acid are another disadvantage. Calcium sulfide caused both atmospheric and water pollution.

**Production from Nepheline.** In the former Soviet Union, pottery clay is produced from nepheline; the process also yields some sodium carbonate [212]. Finely ground nepheline is intimately mixed with very pure limestone, and the mixture is sintered. The following reaction takes place:

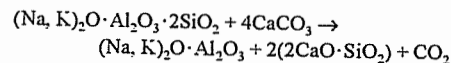

The clinker produced is ground with water to dissolve the sodium and potassium aluminates. The aluminate solution is then treated with CO<sub>2</sub>-containing gas (e.g., combustion gas), to precipitate aluminum oxide hydrate and give a solution of alkali-metal carbonates:

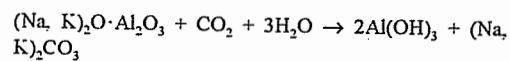

The solution is evaporated and separated into fractions containing various proportions of sodium and potassium carbonate, which differ in solubility. The bicarbonates present in these solutions are converted to carbonates by treatment with alkali-metal hydroxide solution before evaporation.

In the process for converting nepheline to aluminum oxide, 4 t of nepheline gives ca. 1 t of sodium carbonate.

**Other Proposed Modifications of the Ammonia-Soda Process.** Attempts to produce sodium carbonate by other methods have been unsuccessful [213, 214]. A few proposals are mentioned here, although these have not been adopted industrially.

● According to [215], recovery of ammonia by distillation can be avoided by using an intermediate salt; hydrochloric acid is produced in addition to sodium carbonate. The process consists of two stages. In the first,

sodium bicarbonate is precipitated from an ammoniacal solution of sodium sulfate:

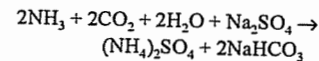

In the second stage, sodium sulfate is regenerated from the mother liquor produced in the above reaction. Here, either pure ammonium sulfate is precipitated in the first step, Na<sub>2</sub>SO<sub>4(s)</sub> + (NH<sub>4</sub>)<sub>2</sub>SO<sub>4(aq)</sub> → Na<sub>2</sub>SO<sub>4(aq)</sub> + (NH<sub>4</sub>)<sub>2</sub>SO<sub>4(s)</sub> or a double salt is produced:

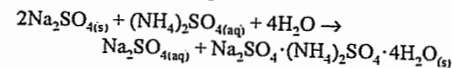

The solid ammonium sulfate obtained is heated with sodium sulfate:

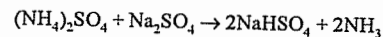

Ammonia is thereby recovered and recycled to the process.

Then, NaHSO<sub>4</sub> is fused with NaCl, to produce hydrogen chloride:

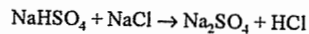

● The following variation of the Solvay process is proposed in [216]: Ammonia from the bicarbonate mother liquor is recovered by reaction with magnesium hydroxide, not calcium oxide. Magnesium chloride and sodium chloride are present in the distillation liquor after removal of ammonia. Magnesium chloride is recovered as the monohydrate by evaporation and then decomposed:

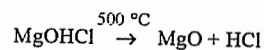
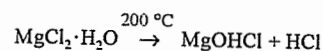

The hydrogen chloride liberated is sold as such or after oxidation to chloride, and magnesium oxide is recycled to the process. Apart from the fact that the hydrogen chloride produced is difficult to market, doubts exist that the decomposition of MgCl<sub>2</sub> is feasible in practice because of corrosion problems.

● The following proposal was made by BLUMBERG et al. [217, 218]. In the equation

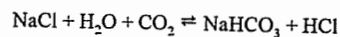

the reaction proceeds to the right if hydrogen chloride is removed. This is achieved by reac-

tion with a C<sub>8</sub>-C<sub>12</sub> tertiary amine dissolved in *n*-pentanol. The amine is regenerated by reaction with magnesium hydroxide. The 26% solution of MgCl<sub>2</sub> produced is thermally decomposed to hydrochloric acid and magnesium oxide, which is recycled to the regeneration stage.

The starting material is brine containing 24-26% NaCl and CO<sub>2</sub> dissolved at a partial pressure of ca. 0.3 MPa. Sodium bicarbonate is precipitated as a solid salt and recovered from the bottom of the vessel. The liquid separates into two phases: a solution of NaCl, which is recycled, and organic solvent saturated with hydrogen chloride. The equations are as follows:

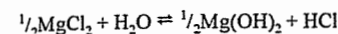
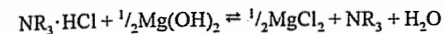
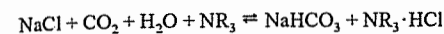

The process is problematic because it results in pollution of the environment with amines and organic solvents. Another problem is the hydrogen chloride by-product.

● The combined production of sodium carbonate, chlorine, and a mixture of ammonium and sodium nitrates has been proposed in [219]. Sodium chloride is oxidized by excess nitric acid, to produce sodium nitrate and chlorine:

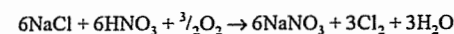

The sodium nitrate solution is neutralized with ammonia and then reacted with carbon dioxide to form sodium bicarbonate.

After the bicarbonate is filtered off, a mixture of ammonium and sodium nitrates that can be used as a fertilizer is recovered from the filtrate.

### Wastewater Problems in Sodium Carbonate Production [220]

In the recovery of ammonia by distillation with milk of lime, an end liquor (ca. 7-10 m<sup>3</sup>/t sodium carbonate) is produced at its boiling point. This liquor has the following approximate composition: 120-180 g/L CaCl<sub>2</sub>, 1.0-

1.7 g/L Ca(OH)<sub>2</sub>, 50-75 g/L NaCl, 1.0-1.5 g/L CaSO<sub>4</sub>, and 20-30 g/L suspended solids. These solids originate mainly from impurities in the limestone and coke, and include uncalcined or dead-burnt limestone. Also, some solid material results from the reaction of milk of lime with residual carbon dioxide not removed in the stripping still.

The solid material consists of ca. 67% CaCO<sub>3</sub>, 10% Mg(OH)<sub>2</sub> + Ca(OH)<sub>2</sub>, 10% CaSO<sub>4</sub>·2H<sub>2</sub>O, 10% SiO<sub>2</sub>, and 3% Fe<sub>2</sub>O<sub>3</sub> + Al<sub>2</sub>O<sub>3</sub>. It is very finely divided and therefore difficult to remove. The liquor is often clarified in large settling basins or ponds. However, mud with a high chloride content is produced, which presents disposal problems. Therefore, the end liquor is frequently diluted with used cooling water and discharged directly into the receiving water body. This method of disposal is generally recognized as safe because calcium carbonate, which is the main solid component in the wastewater, reacts with carbon dioxide in the water to form calcium bicarbonate solution.

The amount of CaCl<sub>2</sub> in the end liquor is given by the overall equation for the Solvay process:

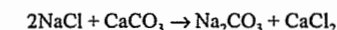

This shows that the reaction produces 1 mol CaCl<sub>2</sub> in the end liquor for each mole of Na<sub>2</sub>CO<sub>3</sub> produced. The end liquor also contains some NaCl resulting from incomplete reaction. Removal of chloride from the end liquor should be considered only if at least some of it can be used to produce calcium chloride. However, this is carried out in only a few sodium carbonate plants, because the demand for this chemical is relatively low.

### 51.15.1.4 Quality Specifications

The product obtained by the ammonia-soda (Solvay) process is, after calcination, an anhydrous, technical-grade sodium carbonate. The two main commercial forms are light soda ash and dense soda ash, which differ in particle size and bulk density. Light soda ash



has a bulk density of 0.5–0.6 kg/L; dense soda ash 1.05–1.15 kg/L.

The quality of the product is normally assessed by the following tests:

- Loss on heating at 250 °C  
Method: Drying of sample at 250 °C for 2 h in a crucible furnace
- Water-insoluble material  
Method: Determination of residues insoluble in water at 50 °C
- Total alkalinity expressed as Na<sub>2</sub>CO<sub>3</sub>  
Method: Titration with 1 M hydrochloric acid, with methyl orange as indicator
- Sodium bicarbonate (NaHCO<sub>3</sub>)  
Method: Winkler titration—conversion of NaHCO<sub>3</sub> to Na<sub>2</sub>CO<sub>3</sub> by addition of a known amount of NaOH; precipitation of total CO<sub>2</sub> as BaCO<sub>3</sub>; back titration of excess NaOH with HCl (indicator: phenolphthalein)
- Sodium carbonate (Na<sub>2</sub>CO<sub>3</sub>)  
Calculation: Total alkalinity (method 3) minus alkalinity due to NaHCO<sub>3</sub> (method 4)
- Sodium chloride (NaCl)  
Methods: a) Mohr's titration against 0.1 M AgNO<sub>3</sub>, with K<sub>2</sub>CrO<sub>4</sub> as indicator  
b) Argentometrically with potentiometric determination of the end point
- Sodium sulfate (Na<sub>2</sub>SO<sub>4</sub>)  
Method: Gravimetrically by precipitation of the sulfate as BaSO<sub>4</sub>
- Iron oxide (Fe<sub>2</sub>O<sub>3</sub>)  
Method: Colorimetric (photometric) determination of the concentration of Fe(II) dipyriddy complex
- Water (H<sub>2</sub>O)  
Calculation: Weight loss at 250 °C (method 1) minus weight loss due to CO<sub>2</sub> + H<sub>2</sub>O determined from decomposition of NaHCO<sub>3</sub> (NaHCO<sub>3</sub> by method 4)

A typical analysis is given below:

|                                 |       |                                |        |
|---------------------------------|-------|--------------------------------|--------|
| Na <sub>2</sub> CO <sub>3</sub> | 99.6% | Fe <sub>2</sub> O <sub>3</sub> | 0.002% |
| NaCl                            | 0.15% | CaO                            | 0.01%  |
| Na <sub>2</sub> SO <sub>4</sub> | 0.02% | MgO                            | 0.02%  |

In addition to its chemical analysis, the product is also characterized by particle size and bulk density.

For soda ash produced from trona, the following are typical analysis figures:

|                                 |        |                                |        |
|---------------------------------|--------|--------------------------------|--------|
| Na <sub>2</sub> CO <sub>3</sub> | 99.6%  | Fe <sub>2</sub> O <sub>3</sub> | 0.001% |
| NaCl                            | 0.035% | CaO                            | 0.01%  |
| Na <sub>2</sub> SO <sub>4</sub> | 0.1%   | MgO                            | 0.003% |

The difference in particle-size distribution between light and dense soda ash is shown by the following value:

|                | Light ash (%) | Dense ash (%) |
|----------------|---------------|---------------|
| > 2mm          | 0.1           | 0.2           |
| 2–1 mm         | 0.5           | 5             |
| 1–0.5 mm       | 1             | 26            |
| 0.5–0.25 mm    | 10            | 50            |
| 0.25–0.125 mm  | 30            | 14            |
| 0.125–0.063 mm | 38            | 4             |
| < 0.063 mm     | 20.4          | 0.8           |

Soda ash of the quality described above is suitable for most applications and is usually adequate for the food industry.

Other special grades include dense granulated soda and briquetted soda. So-called washing soda crystals, the decahydrate Na<sub>2</sub>CO<sub>3</sub>·10H<sub>2</sub>O, is now of minor importance. This is produced from calcined sodium carbonate by dissolving it in boiling water until the density is 30–40 °Bé. Hard crystals are obtained only if the solution contains some sulfate, and a small percentage of this substance is therefore added to the solution. The solution is clarified by allowing solid impurities to sediment. The solution is then cooled to 38 °C in crystallizing troughs to obtain soda crystals. A typical analysis of the commercial product is 36.6% Na<sub>2</sub>CO<sub>3</sub>, 0.03% NaCl, 0.15% Na<sub>2</sub>SO<sub>4</sub>, 63.22% H<sub>2</sub>O.

### 51.15.1.5 Producers

Western Europe producers of soda ash are listed in Table 51.18.

In Eastern Europe plants in the following countries are producing soda ash by the Solvay process: Bulgaria, Poland, Romania, the former Yugoslavia, and the CIS.

The United States has the following production plants:

|                         |                 |
|-------------------------|-----------------|
| FMC Corporation         | Green River, WY |
| General Chemical Corp.  | Green River, WY |
| North American Chemical | Argus, CA       |

|  |                 |
|--|-----------------|
| Rhône-Poulenc  | Green River, WY |
| Solvay Minerals (formerly Temleco) in partnership with Asahi Glass | Green River, WY |
| Texasgulf Chemical Co.   | Green River, WY |

The most important producers outside Europe and the United States are China, India, and Japan.

Table 51.18: Western Europe producers of soda ash.

| Country        | Company                                 | Location                       |
|----------------|---|--------------------------------|
| Germany        | Solvay Deutschland GmbH                 | Rheinberg, Heilbronn, Bernburg |
|                | Chemische Fabrik Kalk GmbH*             | Köln-Kalk                      |
|                | Matthes & Weber GmbH                    | Duisberg                       |
|                | Sodawerk Staßfurt GmbH                  | Staßfurt                       |
|                |   |                                |
| Belgium        | Solvay S.A.                             | Couillet                       |
| France         | Solvay S.A.                             | Dombasle                       |
|                | Rhône-Poulenc                           | La Madeleine                   |
| Italy          | Solvay S.A.                             | Rosignano                      |
| Netherlands    | AKZO                                    | Delfzijl                       |
| Portugal       | Soda Povia S.A.R.L. (Solvay subsidiary) | Povia de Santa Iria            |
| Spain          | Solvay S.A.                             | Torrelavega                    |
| United Kingdom | Penrice Soda Products Ltd.              | Winnington                     |

\* Closure planned for end of 1993.

### 51.15.1.6 Storage and Transport

Calcined soda ash is hygroscopic, gradually taking up moisture and carbon dioxide during transportation and storage. This converts the surface of sodium carbonate to the bicarbonate and leads to a weight increase of up to 17%. Soda ash is therefore best stored in closed, dry areas.

Soda ash is supplied either bulk in silo wagons that can be discharged pneumatically or in paper sacks.

Soda crystals (washing soda) can effloresce or dissolve in the water of crystallization, depending on the temperature and relative humidity. They melt at 32–33 °C. At lower temperature, they are stable, provided the relative humidity is within the limits listed below:

|         |       |       |       |       |
|---------|-------|-------|-------|-------|
| T, °C   | 0     | 10    | 15    | 25    |
| R.H., % | 59–98 | 64–96 | 68–94 | 76–87 |

At lower humidity, soda crystals effloresce, and at higher humidity the surface becomes wet.

### 51.15.1.7 Uses

Soda ash is an important raw material for the chemical industry. Its sodium content results in fluxing properties that make it important in the glass and silicate industries. It is used to neutralize inorganic and organic acids or acidic salts, and to maintain a constant pH in processes where acids are liberated. It is also utilized in the production of sodium salts (e.g., phosphates, nitrates, chromates, citrates, tartrates, salts of fatty acids).

Soda ash can be used in aqueous solution to remove sulfur dioxide from process gas or off-gases, forming sodium sulfite and sodium bicarbonate:

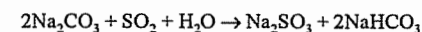
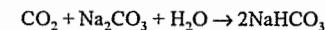
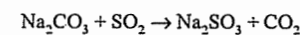

These reactions are also important in the production of paper pulp by the sulfite process.

Other uses of sodium carbonate are as follows:

**Chemical industry:** production of bleaching agents, borax, chromates and dichromates, fertilizers, dyes, fillers, tanning agents, industrial cleaning agents, catalysts, cryolite, adhesives, metal carbonates, sodium nitrate, perborates, phosphates, silicates, ultramarine pigments, soluble silicates, etc.

**Detergent and soap industry:** manufacture of detergents and saponification of fats.

**Petrochemicals:** neutralization.

**Pulp and paper industry:** cooking wood; neutralization, cleaning, bleaching, and treatment of recycled paper.

**Artificial silk industry:** deacidification of artificial silk.

**Textile industry:** dyeing, bleaching, and finishing of wool and cotton.

**Coke ovens, gasworks, and hydrogenation plants:** gas purification (desulfurization).

**Iron and steel industry:** removal of sulfur and phosphorus from pig iron, cast iron, and steel; ore beneficiation, flotation agents, and fluxing agents.

**Heavy-metal industry:** digestion and beneficiation of ores (e.g., of antimony, lead, chrome, cobalt, nickel, bismuth, and tin).

**Glass industry:** raw material for the glass melt and for reacting with sand.

**Aluminum industry:** reaction with bauxite.

**Ceramics industry:** production of refractory materials and glazes.

**Enamel industry:** as a flux.

**Food industry:** hydrolysis of proteins, production of margarine and starch, and softening of sugar beet juice.

**Various branches of industry:** water treatment, metal degreasing.

**Environmental protection:**

- Purification of flue gases by injecting sodium carbonate or sodium hydrogencarbonate (dry process).
- Regeneration of acidic lakes by the introduction of briquettes of sodium carbonate, so that organic sediments exhibit an alkaline reaction over a long period.

### 51.15.1.8 Toxicology

The lowest known lethal dose of sodium carbonate is 4000 mg/kg (rat, oral). Toxic effects do not occur under normal working conditions. For humans, oral ingestion of > 15 g is potentially lethal. In case of ingestion, vomiting should not be induced, but copious amounts of water and dilute lemon juice or vinegar (two tablespoons per glass of water) should be drunk. The stomach can be carefully irrigated for 15 min at most, with the usual precautions, but use of this treatment for longer periods is strongly contraindicated (danger of perforation). Medical help should be sought.

Because of its alkaline reaction, sodium carbonate has a irritating effect on the skin and mucous membranes. If skin is attacked, the affected part should be thoroughly washed with copious quantities of water, and a nonirritant dressing applied if necessary. If eyes are splashed with sodium carbonate, the eyelids should be held open while the eye is treated for several minutes with running water or sa-

line solution. Medical help should be sought from a specialist.

## 51.15.2 Sodium Hydrogencarbonate

### 51.15.2.1 Properties

Some physical properties of sodium hydrogencarbonate are given below:

|                                |  |
|--------------------------------|--|
| Density                        | 2.22 g/cm <sup>3</sup>                   |
| Specific heat capacity (25 °C) | 87.7 kJmol <sup>-1</sup> K <sup>-1</sup> |
| Enthalpy of solution           | -18 kJ/mol                               |
| Enthalpy of formation          | 950 kJ/mol                               |
| Refractive indices             | 1.380, 1.500, 1.586                      |
| Dielectric constant (25 °C)    | 4.39                                     |

Solubility properties are listed in Table 51.19. Solubility is lower in the presence of sodium carbonate.

Table 51.19: Solubility of sodium hydrogencarbonate in water.

| T, °C | Solubility       |                          |
|-------|------------------|--------------------------|
|       | g/100 g solution | g/100 g H <sub>2</sub> O |
| -2.35 | 6.26             | 6.68                     |
| 0     | 6.4              | 6.9                      |
| 10    | 7.6              | 8.2                      |
| 20    | 8.7              | 9.6                      |
| 30    | 10.0             | 11.1                     |
| 40    | 11.3             | 12.7                     |
| 50    | 12.7             | 14.5                     |
| 60    | 14.2             | 16.5                     |
| 80    | 16.5             | 19.7                     |
| 100   | 19.1             | 23.6                     |

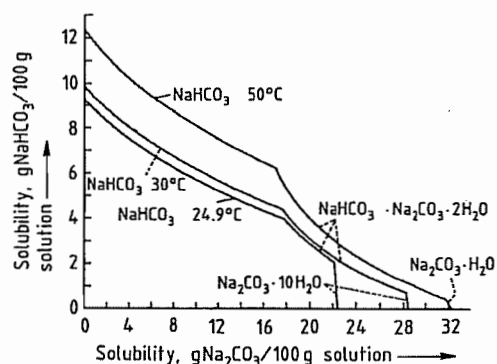
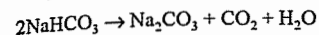

Figure 51.40: Solubilities in the system H<sub>2</sub>O-NaHCO<sub>3</sub>-Na<sub>2</sub>CO<sub>3</sub> at 24.9 °C, 30 °C, and 50 °C [222].

In the system H<sub>2</sub>O-NaHCO<sub>3</sub>-Na<sub>2</sub>CO<sub>3</sub>, the double salt trona NaHCO<sub>3</sub>·Na<sub>2</sub>CO<sub>3</sub>·2H<sub>2</sub>O occurs at > 21.3 °C. The isotherms at 24.9 °C,

30 °C, and 50 °C are shown in Figure 51.40, which indicates the ranges of existence of the solid phases at these temperatures [222, 223].

On heating, sodium hydrogencarbonate decomposes into sodium carbonate, carbon dioxide, and water:



Dissociation pressures of carbon dioxide at equilibrium are as follows:

|                                   |       |      |        |        |        |         |
|-----------------------------------|-------|------|--------|--------|--------|---------|
| T, °C                             | 30    | 50   | 70     | 90     | 100    | 110     |
| p <sub>CO<sub>2</sub></sub> , kPa | 0.825 | 3.99 | 16.013 | 55.102 | 97.236 | 166.596 |

At room temperature, sodium hydrogencarbonate is fairly stable because of its low rate of decomposition. The aqueous solution has an only slightly alkaline reaction due to the small extent of hydrolysis.

### 51.15.2.2 Production

Sodium hydrogencarbonate is an intermediate in the ammonia-soda process. However, because of the content of ammonium salts, a product that satisfies the quality requirements of consumers (mainly in the food industry) cannot be obtained by drying crude bicarbonate. Moreover, a sufficiently pure product cannot be obtained by recrystallization. Therefore, it is necessary to start with an aqueous solution of sodium carbonate which is obtained either by dissolving calcined soda ash or by decomposing crude bicarbonate with steam. This is then filtered and carbonated with pure concentrated carbon dioxide, with cooling to remove the heat of reaction:

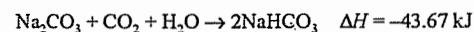

As carbonation proceeds, sodium hydrogencarbonate precipitates. It is recovered by centrifuging and then dried with hot air (e.g., in tray dryers).

### 51.15.2.3 Uses and Quality Specifications

Sodium hydrogencarbonate is used in the manufacture of baking powder, as a medication for neutralizing stomach acid, as a component of effervescent powders, in animal feed, and as a dry-powder fire extinguisher.

The following analysis is typical for the food-grade product: NaHCO<sub>3</sub>, 99.7%; Na<sub>2</sub>CO<sub>3</sub>, 0.2%; NaCl, 0.004%; H<sub>2</sub>O, 0.05%; insolubles, 0.003%.

Sodium hydrogencarbonate tends to form lumps in the presence of moisture or under pressure. On heating to > 60 °C, appreciable decomposition to sodium carbonate occurs. The bicarbonate readily picks up odors from its surroundings and should therefore be stored under dry, airtight conditions.

## 51.16 Sodium Sulfates

### 51.16.1 Sodium Sulfate

#### 51.16.1.1 History and Natural Occurrence

Sodium sulfate has been known since the 1500s. Its use in the form of spa water or as a salt goes back even further. It was first described in 1658 by J. R. GLAUBER. It was known as sal mirabile Glauberi [224], was prepared from common salt and sulfuric acid, and was used medicinally as a laxative. Many kinds of spa water and the salts obtained from them contain sodium sulfate (e.g., Karlsbad salt, which contains 44% sodium sulfate) [225].

Processes for the manufacture of soda and hydrochloric acid that developed in the 1800s involved the production of sodium sulfate (salt cake) [226]. This method has now declined in importance compared to extraction from natural deposits and production as a by-product of chemical processes. By-product sodium sulfate must be removed from wastewater for reasons of environmental protection, which allows largely closed recirculating systems to be established (e.g., for spinning baths in the viscose-fiber industry [227, 228]).

Sodium sulfate not only occurs in salt deposits in ancient geological formations but can also be produced on an industrial scale from continuously formed reserves in salt lakes in Canada, the United States, South America, the

Commonwealth of Independent States, and other countries.

Anhydrous sodium sulfate occurs naturally as thenardite, sometimes in high purity, and Glauber's salt occurs as mirabilite,  $\text{Na}_2\text{SO}_4 \cdot 10\text{H}_2\text{O}$ . In marine salt deposits and in the crystalline deposits that are being produced in salt lakes at the present time, many double salts containing sodium sulfate occur such as astrakhanite,  $\text{Na}_2\text{SO}_4 \cdot \text{MgSO}_4 \cdot 4\text{H}_2\text{O}$ ; glaserite,  $\text{Na}_2\text{SO}_4 \cdot 3\text{K}_2\text{SO}_4$ ; glauberite,  $\text{Na}_2\text{SO}_4 \cdot \text{CaSO}_4$ ; loeweite,  $6\text{Na}_2\text{SO}_4 \cdot 7\text{MgSO}_4 \cdot 15\text{H}_2\text{O}$ ; d'Ansite,  $\text{MgSO}_4 \cdot 9\text{Na}_2\text{SO}_4 \cdot 3\text{NaCl}$ ; vanthoffite,  $\text{MgSO}_4 \cdot 3\text{Na}_2\text{SO}_4$ ; burkeite  $\text{Na}_2\text{CO}_3 \cdot 2\text{Na}_2\text{SO}_4$ ; and hanksite,  $\text{KCl} \cdot 2\text{Na}_2\text{CO}_3 \cdot 9\text{Na}_2\text{SO}_4$ . Hence, the industrial production of sodium sulfate can be combined with the production of common salt, soda, or potash salts [229–233].

### 51.16.1.2 Properties

**Physical Properties.** Table 51.20 compares the properties of thenardite (anhydrous sodium sulfate) and Glauber's salt (the decahydrate). The heptahydrate,  $\text{Na}_2\text{SO}_4 \cdot 7\text{H}_2\text{O}$ , is unstable (Figure 51.41) and can be detected on cooling saturated solutions to  $< 12^\circ\text{C}$  [234–236].

Table 51.21 lists the solubility of sodium sulfate in water [234, 235, 237–239]. Sodium sulfate is polymorphic; above  $240^\circ\text{C}$ , four other modifications are formed from thenard-

ite (Table 51.21) [237]. In the sodium sulfate–water system, a transformation occurs at a temperature that has been determined with great accuracy ( $32.384^\circ\text{C}$ ) and is suitable as a fixed point. Above this temperature, anhydrous thenardite crystallizes from saturated solutions, and below it, Glauber's salt (Figure 51.41).

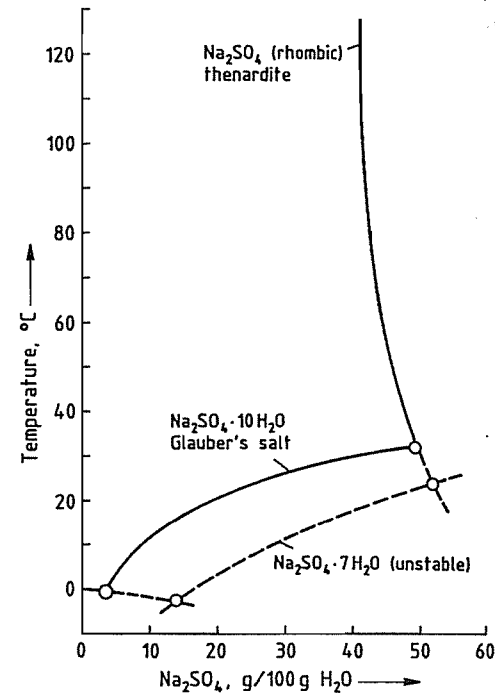

Figure 51.41: Solubility of sodium sulfate.

Table 51.20: Properties of thenardite and Glauber's salt.

| Property  | Thenardite, $\text{Na}_2\text{SO}_4$   | Glauber's salt, $\text{Na}_2\text{SO}_4 \cdot 10\text{H}_2\text{O}$                                       |
|---|--|---|
| Water of crystallization, %   | 0                                      | 55.914  |
| mp, $^\circ\text{C}$  | 884.0 (decomp. $> 884^\circ\text{C}$ ) | "melts" at $32.384^\circ\text{C}$ in its own water of crystallization (decomp. $> 32.384^\circ\text{C}$ ) |
| Crystal habit   | rhombic                                | monoclinic  |
| Unit cell dimensions  | 0.586, 1.23, 0.982                     | 1.143, 1.034, 1.290 (angle = $107^\circ 40'$ )  |
| No. of molecules in unit cell   | 8                                      | 4   |
| Refractive indices $n_D$  | 1.464, 1.474, 1.485                    | 1.394, 1.396, 1.398   |
| Density, $\text{g}/\text{cm}^3$   | 2.697                                  | 1.468   |
| Specific heat capacity $c_p$ at 300 K, $\text{J}/\text{kg} \cdot \text{K}^{-1}$ | 899.2                                  | 1825.7  |
| Heat of fusion, $\text{kJ}/\text{kg}$   | 147.98                                 | 214.52  |
| Heat of sublimation at $18^\circ\text{C}$ , $\text{kJ}/\text{kg}$               | 16.2                                   | -243.8  |
| Enthalpy of formation, $\text{kJ}/\text{mol}$                                   | -138.5                                 | -4327   |
| Entropy $S^\circ$ , $\text{J}/\text{mol} \cdot \text{K}^{-1}$                   | 149.60                                 | 588.2   |
| Dielectric constant (at $10^3$ Hz)  | 7.80                                   | 7.90  |
| Mohs hardness   | 2.7                                    | 1.5–2   |

Table 51.21: Solubility of sodium sulfate in water.

| Temperature, $^\circ\text{C}$ | g $\text{Na}_2\text{SO}_4$ in |                |
|-------------------------------|-------------------------------|----------------|
|                               | 100 g $\text{H}_2\text{O}^a$  | 100 g solution |
| -1.2                          | 3.9a                          | 3.8            |
| 0                             | 4.5b                          | 4.3            |
| 5                             | 6.2b                          | 5.8            |
| 10                            | 9.0b                          | 8.3            |
| 15                            | 13.2b                         | 11.7           |
| 18                            | 16.4b                         | 14.1           |
| 20                            | 19.0b                         | 16.0           |
| 22                            | 22.1b                         | 18.1           |
| 24                            | 25.8b                         | 20.5           |
| 25                            | 27.8b                         | 21.8           |
| 30                            | 41.2b                         | 29.2           |
| 32.4                          | 49.7b,c                       | 33.2           |
| 35                            | 49.1c                         | 32.9           |
| 40                            | 48.1c                         | 32.5           |
| 50                            | 46.4c                         | 31.7           |
| 60                            | 45.3c                         | 31.2           |
| 70                            | 44.2c                         | 30.7           |
| 80                            | 43.2c                         | 30.2           |
| 90                            | 42.6c                         | 29.9           |
| 100                           | 42.2c                         | 29.7           |
| 110                           | 42.0c                         | 29.6           |
| 150                           | 42.2c                         | 29.7           |
| 200                           | 44.1c                         | 30.6           |
| 240                           | 44.9c,d                       | 31.0           |
| 250                           | 44.0d                         | 30.5           |
| 260                           | 41.8d                         | 29.5           |
| 270                           | 38.8d                         | 28.0           |
| 280                           | 35.2d                         | 26.0           |
| 290                           | 30.8d                         | 23.5           |
| 300                           | 24.8d                         | 19.9           |
| 310                           | 18.5d                         | 15.6           |
| 320                           | 13.1d                         | 11.6           |
| 330                           | 7.3d                          | 6.8            |
| 340                           | 4.2d                          | 4.0            |
| 350                           | 2.4d                          | 2.3            |
| 360                           | 0.9d                          | 0.9            |
| 382                           | 0.38d                         | 0.38           |

<sup>a</sup> Solid phases: a =  $\text{Na}_2\text{SO}_4 \cdot 10\text{H}_2\text{O} + \text{ice}$ ; b =  $\text{Na}_2\text{SO}_4 \cdot 10\text{H}_2\text{O}$ ; c =  $\text{Na}_2\text{SO}_4$ , rhombic (thenardite); d =  $\gamma\text{-Na}_2\text{SO}_4$ , hexagonal (transforms into rhombic  $\beta\text{-Na}_2\text{SO}_4$  on cooling below  $240^\circ\text{C}$  and into monoclinic  $\alpha\text{-Na}_2\text{SO}_4$  on cooling below  $180^\circ\text{C}$ ; this is unstable in aqueous solution and transforms into thenardite).

The decrease in solubility of sodium sulfate resulting from the presence of sodium chloride can be utilized in the industrial production of sodium sulfate from aqueous solutions. This effect is shown by the three-component system sodium sulfate–sodium chloride–water (Table 51.22) [225, 240, 241].

The system sodium sulfate–sulfuric acid–water shows first an increase and then a decrease in the solubility of sodium sulfate with

increasing sulfuric acid concentration [225, 238, 241]. The reaction to form sodium hydrogensulfate is of industrial importance.

The low solubility of sodium sulfate in organic solvents or mixtures of these with water can be used in the precipitation crystallization of thenardite [228, 238, 242].

Table 51.22: Solubility (%) of sodium sulfate in water and sodium chloride solutions.

| Temperature, $^\circ\text{C}$ | NaCl content of solution, % |                      |                      |       |      |
|-------------------------------|-----------------------------|----------------------|----------------------|-------|------|
|                               | 0                           | 10                   | 14                   | 17    | 20   |
| 10                            | 8.25a <sup>a</sup>          | 3.9a                 | 3.3a                 | 3.2a  | 3.3a |
| 15                            | 11.7a                       | 6.4a                 | 5.5a                 | 5.2a  | 5.5a |
| 17.5                          | 13.7a                       | 8.1a                 | 7.4a                 | 6.8a  | 7.1c |
| 25                            | 21.8a                       | 15.7a                | 14.9a,b <sup>b</sup> | 11.8b | 9.2c |
| 30                            | 29.9a                       | 19.2a,b <sup>b</sup> | 14.2b                | 10.8b | 8.5c |
| 33                            | 33.2a,b <sup>b</sup>        | 18.9b                | 14.2b                | 11.2b | 8.9c |
| 50                            | 31.7b                       | 18.3b                | 13.7b                | 10.3b | 6.7c |
| 75                            | 30.4b                       | 17.3b                | 13.0b                | 9.9b  | 8.1c |
| 100                           | 29.7b                       | 16.7b                | 12.8b                | 10.0b | 7.8c |

<sup>a</sup> Solid phases: a =  $\text{Na}_2\text{SO}_4 \cdot 10\text{H}_2\text{O}$ ; b =  $\text{Na}_2\text{SO}_4$  (thenardite); c = mixtures with NaCl.

<sup>b</sup> The transformation temperature of  $32.384^\circ\text{C}$  is depressed to  $17.9^\circ\text{C}$  by NaCl.

**Chemical Properties.** In moist air, anhydrous sodium sulfate takes up water of crystallization with a considerable increase in volume, which reaches a factor of 4.17 on complete conversion to the decahydrate (Glauber's salt) and can lead to damage if the change occurs in cracks in buildings. Buildings constructed with cement, especially those made of concrete, can be destroyed by solutions containing sodium sulfate. Glauber's salt is not hygroscopic. It effloresces and is converted to an almost anhydrous sulfate after a few days in a cold current of air.

On heating below its melting point ( $884^\circ\text{C}$ ), thenardite decomposes slowly. Above  $1200^\circ\text{C}$ , the weight loss of the molten material can be several percent. If sodium sulfate is added to molten glass, sodium silicates are formed, and sulfur dioxide and oxygen are released (see Table 51.25).

### 51.16.1.3 Extraction and Production

Of the world production of sodium sulfate (ca.  $4.6 \times 10^6$  t in 1988), approximately 50% is

a by-product of the chemical industry, the remainder being extracted from natural deposits. World reserves of sodium sulfate are estimated at  $3400 \times 10^6$  t [243, 244].

The extraction of sodium sulfate from wastewater from the chemical industry has a beneficial effect on the environment and has the further advantage that it is independent of weather conditions, in contrast to production from natural sources [228, 243]. Furthermore, the production plant is usually close to the consumer of the sodium sulfate, whereas production from natural deposits often takes place in remote regions.

Glauber's salt is not a commercial product, owing to its high content of water of crystallization (56%) and consequently high transportation costs, its low melting point (32.4 °C), and its tendency to effloresce. However, it is an important intermediate product in many processes.

### Crystallization and Calcination

The principle of the crystallization process is to cool the solution to  $< 20$  °C, causing Glauber's salt,  $\text{Na}_2\text{SO}_4 \cdot 10\text{H}_2\text{O}$ , to crystallize [225, 245]. Multistage vacuum-cooled crystallizers are used, usually of the horizontal type. Glauber's salt is recovered and calcined to form anhydrous sodium sulfate (thenardite) in the next stage. Glauber's salt "melts" in its own water of crystallization at 32.38 °C, forming a saturated solution of sodium sulfate that contains anhydrous sodium sulfate as a solid phase (37% of the sodium sulfate from the Glauber's salt). In older processes, the saturated sodium sulfate solution, after removal of the precipitated sodium sulfate, was once again vacuum cooled, and the Glauber's salt that crystallized was again recovered and melted. If Glauber's salt was again crystallized from the residual mother liquor, up to 85% of the total Glauber's salt could be recovered as anhydrous sulfate.

This energy-intensive process was superseded by evaporative crystallization of the saturated sodium sulfate solution obtained on melting Glauber's salt [246–251]. The energy

consumption was reduced further by using multistage evaporation, in which the vapor was employed as heating steam for the following stage, which was operated at lower pressure. Further savings resulted from the use of mechanical or thermal compression of the vapor [252–254].

The formation of encrustations in the heat exchangers presented a problem, especially in the heat exchangers of the Glauber's salt melting vessels because of the decreasing solubility of sodium sulfate above 32 °C [225, 255]. For this reason, unheated melting vessels were often used, in which Glauber's salt was melted by mixing with approximately 15 times the amount of hot, saturated sodium sulfate solution from the evaporation stages [249].

The formation of encrustations can also be prevented if the heating medium for the melting vessel has such a low temperature (e.g., vapor from the last evaporation stage) that the temperature increase of the circulating melt solution in the heat exchanger is limited to 1–3 °C per pass [256].

In another process, part of the sodium sulfate solution is evaporated at 108–114 °C and pressures of up to 0.15 MPa absolute [257]. In this temperature range, the solubility curve of sodium sulfate exhibits a minimum, so that crust formation in the heat exchanger of the evaporator is greatly reduced. The vapor from this first stage is used as the heating medium for the evaporator of the second stage, which operates with vapor compression.

The purity of the sodium sulfate produced can be controlled by varying the amount of mother liquor removed at the calcination stage. Here, the saturation concentrations of the dissolved impurities must not be exceeded [258]. These processes can then yield a very pure sodium sulfate ( $> 99.9\%$ ). The mother liquor can be fed to a biological wastewater treatment plant or worked up to yield Glauber's salt [259].

Figure 51.42 shows a flow diagram of a plant for the production of sodium sulfate from wastewater [228].

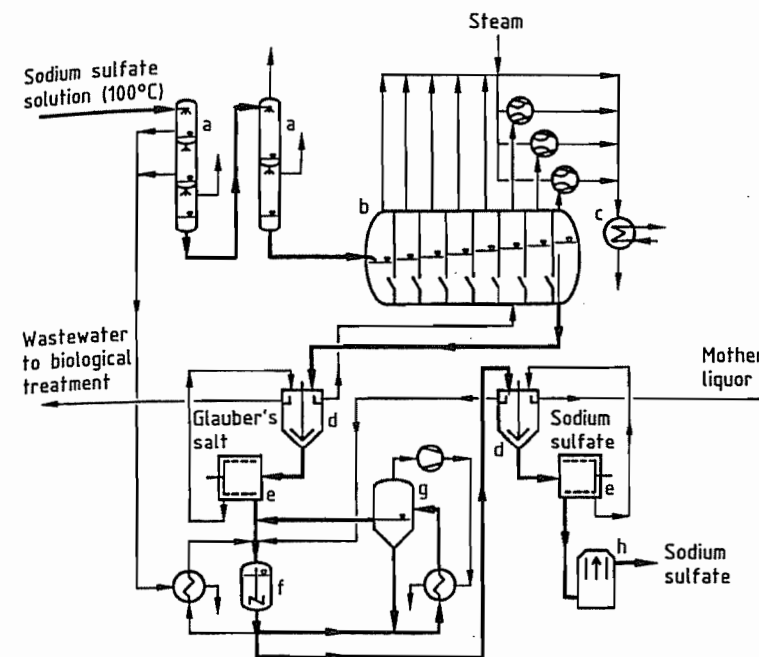

Figure 51.42: Production of sodium sulfate by crystallization and calcination: a) Evaporative cooler; b) Vacuum cooling crystallizer; c) Cooler; d) Thickener; e) Centrifuge; f) Melting vessel; g) Evaporator; h) Dryer.

The formation of encrustations during the thermal dehydration of Glauber's salt can be largely prevented by the use of air, spray, or fluidized-bed dryers, which have no solid heat-exchange surfaces. For example, in the Holland evaporator, predried Glauber's salt is heated by combustion gases at 870–980 °C in a rotary dryer to produce thenardite. If the Glauber's salt is melted and thenardite is separated, the mother liquor can be spray-dried with hot combustion gases. The specific energy consumption can be reduced if molten Glauber's salt in the form of a crystal slurry is sprayed into a rotary dryer heated to 150–400 °C. In fluidized-bed drying, thenardite is produced with hot air at 450 °C, giving a waste gas temperature of 80–100 °C. The fines are recirculated, producing a dust-free sodium sulfate with a grain size that can be controlled up to 4.8 mm.

In these processes, the entire water of crystallization is evaporated, so that the impurities in Glauber's salt remain in the sodium sulfate [225, 260–262]. Sodium sulfate can be precipi-

tated as thenardite from aqueous solutions by adding water-soluble organic solvents such as methanol [225, 263–266]. This process is used in the treatment of solutions containing  $\text{Na}_2\text{SO}_4$  and sulfuric acid from the cellulose industry [267, 268].

Sodium sulfate can also be obtained from Glauber's salt by using submerged combustion heaters. However, the burner must be cleaned or changed frequently due to corrosion and encrustation [225, 243].

Sodium sulfate can be separated from mixtures of solid salts by flotation. This process is being investigated for the treatment of salt mixtures from natural deposits [269].

### Production as a By-product of the Chemical Industry

Solutions of sodium sulfate are produced in numerous reactions of sodium compounds with sulfuric acid or with sulfur dioxide and oxygen. These solutions must be treated to prevent water pollution. Sodium sulfate is ob-

tained from them by crystallization and calcination. The quantities of sodium sulfate produced as a by-product from various sources depend very much on the state of the market for the main products and the state of the technology. In spite of this, total production of by-product sodium sulfate has hardly changed since 1980 [243].

**From Viscose-Fiber Spinning Baths.** Fibers are produced by spinning viscose in a sulfuric acid precipitation bath in which the following reaction takes place:

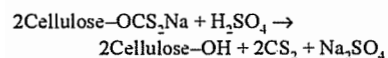

The precipitation bath contains ca. 10%  $\text{H}_2\text{SO}_4$ , 20%  $\text{Na}_2\text{SO}_4$ , and 1%  $\text{ZnSO}_4$ . The spinning process produces ca. 1 kg of sodium sulfate for each kilogram of viscose fiber. Sulfuric acid must therefore be added continuously to the bath, and sodium sulfate removed [225, 227].

The treatment process for the bath consists of multistage evaporation, followed by cooling of the concentrated solution from 50 °C to 0.5 °C in a crystallizer. Glauber's salt is removed by centrifuges, and the mother liquor is recycled to the spinning bath. The zinc sulfate

dissolved in the spinning bath does not crystallize. Thenardite containing 99.6–99.9% sodium sulfate is produced by calcination of Glauber's salt in evaporating crystallizers, with partial recycle of the mother liquor [246, 270–273]. In Western Europe in 1988, 305 000 t of sodium sulfate was produced from viscose-fiber manufacture, and in the United States in 1989, 89 000 t [243].

**From Sodium Dichromate Production.** Sodium sulfate is produced by the acidification of sodium chromate solution with sulfuric acid according to the equation:

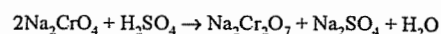

If the reaction is carried out above 32.4 °C, thenardite (> 99%  $\text{Na}_2\text{SO}_4$ ) precipitates. This still contains 0.2% dichromate, which can be removed by dissolving, reducing with  $\text{SO}_2$ , and filtering off chromium(III) oxide. If the sodium sulfate is used in the sulfate cellulose (Kraft) process, the dichromate is reduced and therefore does not cause problems [244, 274, 275].

Quantities of sodium sulfate obtained from sodium dichromate production in 1988–1989 were 70 000 t/a in western Europe and 110 000 t/a in the United States [243].

**Table 51.23:** Sodium sulfate as a by-product of chemical processes.

| Process                                    | Reaction  | References           |
|--|---|----------------------|
| Production of boric acid                   | $\text{Na}_2\text{B}_4\text{O}_7 + \text{H}_2\text{SO}_4 + 5\text{H}_2\text{O} \rightarrow 4\text{H}_3\text{BO}_3 + \text{Na}_2\text{SO}_4$   | <sup>a</sup>         |
| Production of chlorine dioxide             | $2\text{NaClO}_3 + \text{SO}_2 \rightarrow 2\text{ClO}_2 + \text{Na}_2\text{SO}_4$  | [267, 277–279]       |
| Production of hydroxylamine                | $2\text{HON}(\text{SO}_3)_2(\text{Na}, \text{NH}_4) + 4\text{H}_2\text{O} \rightarrow (\text{HONH}_2)_2 \cdot \text{H}_2\text{SO}_4 + \text{Na}_2\text{SO}_4 + 2\text{NH}_4\text{HSO}_4$  | [280, 281]           |
| Production of lithium carbonate            | $\text{Li}_2\text{SO}_4 + \text{Na}_2\text{CO}_3 \rightarrow \text{Li}_2\text{CO}_3 + \text{Na}_2\text{SO}_4$   | [243]                |
| Production of resorcinol or naphthol       | $\text{C}_6\text{H}_4(\text{ONa})_2 + 2\text{NaHSO}_3 + 2\text{H}_2\text{SO}_4 \rightarrow \text{C}_6\text{H}_4(\text{OH})_2 + 2\text{Na}_2\text{SO}_4 + 2\text{SO}_2 + 2\text{H}_2\text{O}$  | [243, 282, 283]      |
| Production of methionine                   | $2\text{CH}_3\text{S-CH}_2\text{CH}_2\text{CH}(\text{NH}_2)\text{-COONa} + \text{H}_2\text{SO}_4 \rightarrow 2\text{CH}_3\text{S-CH}_2\text{CH}_2\text{CH}(\text{NH}_2)\text{-COOH} + \text{Na}_2\text{SO}_4$   | [243]                |
| Production of formic acid                  | $2\text{HCOONa} + \text{H}_2\text{SO}_4 \rightarrow 2\text{HCOOH} + \text{Na}_2\text{SO}_4$   | [243, 284]           |
| Neutralization of waste sulfuric acid      | $2\text{NaOH} + \text{H}_2\text{SO}_4 \rightarrow \text{Na}_2\text{SO}_4 + 2\text{H}_2\text{O}$   | [285–288]            |
| Roasting and chlorination of pyrite cinder | $2\text{Cu}_2\text{S} + 4\text{FeSO}_4 + 8\text{NaCl} + 5\text{O}_2 \rightarrow 4\text{Na}_2\text{SO}_4 + 4\text{CuCl}_2 + 2\text{Fe}_2\text{O}_3 + 2\text{SO}_2$   | [225, 243, 246, 289] |
| Desulfurization of flue gases              | $2\text{Na}_2\text{SO}_3 + \text{O}_2 \rightarrow 2\text{Na}_2\text{SO}_4$ ; $2\text{Na}_2\text{SO}_3 + \text{SO}_3 \rightarrow \text{Na}_2\text{SO}_4 + \text{Na}_2\text{S}_2\text{O}_5$ ; $2\text{Na}_2\text{SO}_3 + \text{Na}_2\text{S}_2\text{O}_5 \rightarrow 2\text{Na}_2\text{SO}_4 + \text{Na}_2\text{S}_2\text{O}_3$ | [290–294]            |

<sup>a</sup> See Section 49.8.

**From Ascorbic Acid Production.** In the synthesis of ascorbic acid by the Reichstein-Grüssner process, sulfuric acid is used in the production of the diacetone-L-sorbose intermediate. The sulfuric acid is neutralized with sodium hydroxide solution in a later stage of the process [276]. On removal of the solvent, a saturated solution of  $\text{Na}_2\text{SO}_4$  is produced, from which thenardite (> 99.9%  $\text{Na}_2\text{SO}_4$ ) is obtained by evaporative crystallization. For each tonne of ascorbic acid, 1.5 t of sodium sulfate is produced. In 1988–1989, 45 000 t/a  $\text{Na}_2\text{SO}_4$  was produced in this way in western Europe, and 17 000 t/a in the United States [243].

**From Other Processes.** Sodium sulfate is also produced in various quantities from a large number of other chemical processes (Table 51.23).

### Production from Natural Sources

The most important production plants for sodium sulfate from natural sources are located in Canada, Spain, Mexico, Turkey, the United States, and the CIS. The output from these countries in 1987–1989 was ca.  $2 \times 10^6$  t/a [243].

Owing to the varying compositions of the salt mixtures in the deposits, many types of processes for the production of sodium sulfate and other compounds have been developed [225, 269, 295, 296]. A review of some important production methods is given here.

**Production in Canada.** The Canadian deposits are located in Alberta and Saskatchewan, and are in the form of shallow lakes with only a few inlets. These contain sodium sulfate in the form of brines or deposits of mirabilite ( $\text{Na}_2\text{SO}_4 \cdot 10\text{H}_2\text{O}$ ). Mirabilite dissolves from the deposits to an extent that depends on annual temperature variations, amount of water entering the lake, and evaporation. Various processes are used to recover the product.

Brine is pumped into shallow basins, from which some of the water evaporates during the summer. In winter, mirabilite crystallizes (ca. 600 kg/m<sup>3</sup> brine) and collects at the bottom of

the basin. Excess brine is pumped back into the lake. Mirabilite is then collected by means of drag lines or other equipment and taken for further treatment.

Other operations use floating dredges to mine permanent deposits of mirabilite from the lake beds. The slurry of mirabilite and brine is sent by pipeline for further treatment.

In a third method, brine is produced by dissolving the salt in situ with hot water, which is injected via a large number of boreholes into the body of salt lying under the brine. The solution produced is taken to the next stage of treatment, which consists of precipitating crude salt in cooling towers [225, 243, 295, 297, 298].

In some cases, dry deposits of mirabilite are mined conventionally, and the crude salt can then be transported to the processing plant.

The crude salt is charged into evaporators, where it "melts" in its own water of crystallization. The crystal suspension is then evaporated with hot combustion gases and transported to rotary dryers by belt conveyors.

In operations that send a brine for processing, Glauber's salt is crystallized by cascading the brine in contact with cold air [243, 298]. Entrained clay slime can be removed in centrifuges. The Glauber's salt melt is then evaporated by the submerged combustion of natural gas. Sodium sulfate (97–99.8%  $\text{Na}_2\text{SO}_4$ ) with a controlled grain size is produced by grinding and screening. Total production in Canada in 1987–1988 was 312 000 t/a sodium sulfate [243].

**Production in Spain.** Glauberite deposits are mined in the provinces of Burgos, Toledo, and Madrid. The Castellar mine at Toledo produces a crude salt containing 67%  $\text{Na}_2\text{SO}_4$ , 19%  $\text{CaSO}_4$ , and 12% clay and shale, from which sodium sulfate can be produced in various ways [225, 230, 299, 300]. For example, sodium sulfate can be leached from the crude salt at 35–40 °C (stage 1). The residue contains slime (clay) and glauberite ( $\text{Na}_2\text{SO}_4 \cdot \text{CaSO}_4$ ), which is stable above 29 °C. Below 29 °C, this solid material yields additional sodium sulfate solution, which is

recycled to the first stage. Thenardite is produced from the leachate by vacuum evaporation. The three deposits yielded 510 000 t of sodium sulfate in 1988 [243].

**Production in the United States, Mexico, Turkey, and the Commonwealth of Independent States.** Sodium sulfate is obtained from natural deposits in California, Texas, and Utah.

Brine containing sodium carbonate is obtained by sinking wells into the deeper layers below the salt crust of Searles Lake in California. The brine is treated with carbon dioxide to precipitate sodium hydrogencarbonate, from which sodium carbonate is obtained. The filtrate is then cooled to 15 °C to precipitate borax, which is filtered off. Further cooling to 5–6 °C causes Glauber's salt to crystallize. The decahydrate still contains some finely divided borax, which can be removed by hydraulic screening. Only Glauber's salt with a grain size of > 0.8 mm is dehydrated to form thenardite. The fine crystals are used as crystallization seeds [225, 243, 295, 301]. In 1989, 218 000 t of sodium sulfate was produced.

In Texas, brine from deposits close to the surface is treated. In Seagraves, Glauber's salt is separated from brine saturated with sodium chloride at –7 to –10 °C. The product obtained is melted and evaporated by submerged gas burners to produce thenardite. The thenardite suspension is centrifuged and dried to yield a product containing 99.7% Na<sub>2</sub>SO<sub>4</sub> [225, 243, 295, 302]. In 1989, ca. 140 000 t of sodium sulfate was produced by this method [20].

A sodium sulfate production plant in Utah uses brine from the Great Salt Lake. The brine is pumped into solar evaporation ponds with a surface area of ca. 80 km<sup>2</sup>. Each year, stepwise crystallization of sodium chloride, potassium salts, and Glauber's salt takes place. These are removed by scrapers and transported by road vehicles for treatment. The crude salt is dissolved, the saturated solution is filtered, and sodium chloride is added to precipitate thenardite, which, after filtration and drying, contains > 94% Na<sub>2</sub>SO<sub>4</sub>. Recrystallization gives thenardite containing > 99.7% Na<sub>2</sub>SO<sub>4</sub> [225,

229, 243, 303]. In 1989, 25 000 t of Na<sub>2</sub>SO<sub>4</sub> was produced [243].

Sodium sulfate production figures for Mexico, Turkey, and the Soviet Union are listed in Table 51.24.

**Table 51.24:** Production of sodium sulfate in Mexico, Turkey, and the Soviet Union in 1987–1988.

| Country      | Starting material                | Sodium sulfate production, t/a | References |
|--------------|----------------------------------|--------------------------------|------------|
| Mexico       | Brine from salt lakes            | 420 000                        | [243]      |
| Turkey       | Crude salts from salt lakes      | 157 000                        | [243]      |
| Soviet Union | Water from the Caspian Sea, etc. | 375 000                        | [243, 295] |

### Production

In addition to production methods based on by-product material or natural deposits of sodium sulfate, processes are also operated in which sodium sulfate is manufactured from compounds that contain sodium and sulfate.

**From Sodium Chloride and Sulfuric Acid (Mannheim Process).** The thermal reaction

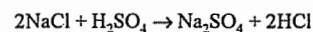

which takes place via the intermediate formation of sodium hydrogensulfate, was developed as part of the Leblanc sodium carbonate process [226]. The reaction produces sodium sulfate and hydrogen chloride, which are of comparable economic importance [243].

This process is often carried out in Mannheim furnaces [225, 244, 286, 304, 305], which have a diameter of 6 m and produce 25 t/d sodium sulfate and 37.5 t/d hydrochloric acid (31%) by addition of 93–96% sulfuric acid to sodium chloride. One tonne of sulfate requires  $3.6 \times 10^6$  kJ (88 kg of fuel oil), 65 kWh, 1.4 m<sup>3</sup> of process water, and 26 m<sup>3</sup> of cooling water. The product contains 97–99.7% Na<sub>2</sub>SO<sub>4</sub>. The small amounts of free sulfuric acid in the product are neutralized during cooling in a rotary cooler by the addition of sodium carbonate. The commercial product is obtained by grinding and screening.

The Climax Chemical Co., United States, operates a plant in which sodium chloride and sulfuric acid are reacted by the Cannon fluid-

ized-bed process. Production costs are lower than with the furnace process [225, 243, 306].

In 1988–1989, ca. 390 000 t/a sodium sulfate was produced from sodium chloride and sulfuric acid [243].

Sodium sulfate can be produced from dilute sulfuric acid and sodium chloride in a spray evaporator [285, 307].

**The Hargreaves Process.** Up to 1983, the Morton Chemical Co. in Louisiana, United States, operated the Hargreaves process, which is based on the reaction

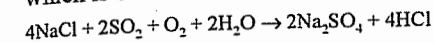

This process is of interest owing to its low energy consumption compared to other production processes. Mannheim furnaces were used for the reaction, but rotary kilns or fluidized-bed reactors have been proposed [225, 243, 305, 308–310].

**Metathesis.** Several processes have been developed for the conversion of sodium chloride to sodium sulfate, for example,

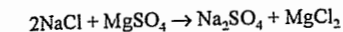

Of these processes, the reaction of sodium chloride with kieserite (MgSO<sub>4</sub>·H<sub>2</sub>O) is the most important, because of all the crude salts from German potash production, kieserite is the cheapest source of sulfate.

To obtain a good yield of Glauber's salt, it is important to have the optimum NaCl/MgSO<sub>4</sub> ratio in the starting liquor. In the five-component system Mg–Na<sub>2</sub>–SO<sub>4</sub>–Cl<sub>2</sub>–H<sub>2</sub>O, an optimum point exists for the composition of the starting liquor. During dehydration of Glauber's salt, sodium chloride is added to the mother liquor, causing thenardite to precipitate. The mother liquor can then be used to produce the starting liquor. The process produces thenardite containing 98.7–99.5% Na<sub>2</sub>SO<sub>4</sub> [225, 229, 263, 311–313]. In 1988, ca. 118 000 t of Na<sub>2</sub>SO<sub>4</sub> was produced [243].

### 51.16.1.4 By-product Sodium Sulfate

Sodium sulfate is produced in a number of chemical processes and must be utilized or

disposed of. Hence, processes for converting sodium sulfate into its constituents (sodium hydroxide and sulfuric acid) or into other useful chemicals are of interest [228, 243].

### Electrochemical Decomposition of Sodium Sulfate

The electrochemical decomposition of sodium sulfate takes place according to the overall reaction:

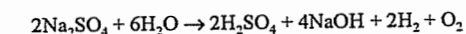

The anodic decomposition of water produces H<sup>+</sup> ions and oxygen

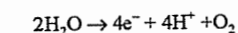

and the corresponding cathodic reaction produces OH<sup>–</sup> ions and hydrogen

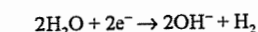

If sodium hydroxide solution and sulfuric acid are required, reverse reaction between H<sup>+</sup> and OH<sup>–</sup> must be prevented. This can be achieved by using a mercury cathode or a diaphragm cell [228].

The use of cation- and anion-selective ion-exchange membranes has led to new developments in recent years. Figure 51.43 shows the principle of Na<sub>2</sub>SO<sub>4</sub> decomposition by electro dialysis in a cell divided into three zones by a cation-exchange membrane (CM) and an anion-exchange membrane (AM). The sulfate solution flows through the central zone. Sodium hydroxide and hydrogen are formed in the cathode space, and sulfuric acid and oxygen in the anode space. Sulfuric acid (5–15%) and sodium hydroxide (15–20%) are obtained with an energy consumption of 3500–4000 kWh/t NaOH and a current efficiency of 60–80%. The consumption of electrical energy can be reduced by using the reaction gases H<sub>2</sub> and O<sub>2</sub> in a fuel cell, or by the use of electro dialysis cells with gas-diffusion electrodes [314, 315].

Further improvements in electro dialysis are achieved by using anion-exchange membranes composed of styrenedivinylbenzene copolymer with strongly basic quaternary ammonium groups and a hydronium ion blocker.

This gives improved current efficiencies and more concentrated sodium hydroxide and sulfuric acid [316].

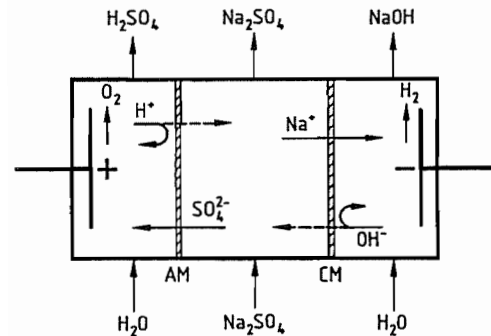

Figure 51.43: Decomposition of sodium sulfate by electro-dialysis.

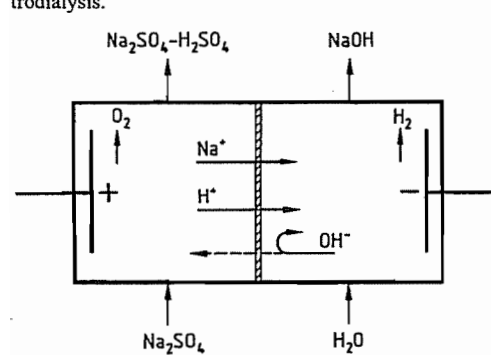

Figure 51.44: Electrolysis of sodium sulfate solution.

Figure 51.44 shows a two-compartment cell divided by a cation-exchange membrane. The sulfate solution is charged into the anode space where it becomes enriched in sulfuric acid; only salt-containing acid can be produced. The sodium hydroxide in the cathode space is almost free of sulfate [317]. As the acid concentration increases and the salt concentration decreases, more  $H^+$  ions contribute to the transport of current. Therefore, the current efficiency depends not only on the selectivity of the membrane and the sodium hydroxide concentration in the catholyte, but also on the  $H^+/Na^+$  ratio in the anolyte. High current efficiencies are obtained only with an excess of  $Na^+$  ions. For example, if the molar  $H^+/Na^+$  ratio in the anolyte is 1:1, 5–10% sulfuric acid and 15–25% sodium hydroxide are obtained with current efficiencies of 65–70%.

Electrolysis of highly concentrated sodium sulfate solutions (up to 39%  $Na_2SO_4$ ) gives sulfuric acid concentrations of 10–20% and sodium hydroxide contents of 15–20% with current efficiencies of 65–80% [318].

In the Sulfomat process, sodium sulfate is electrolyzed to give sodium sulfate-containing sulfuric acid and caustic soda solution. The latter is used for absorption of  $SO_2$  in flue gas desulfurization, giving a solution of sodium sulfite. Acidification with the  $Na_2SO_4$ -containing sulfuric acid gives  $SO_2$  and reforms sodium sulfate, which is electrolyzed [319]. Also, spinning bath solutions from the viscose-fiber industry can be regenerated electrochemically [320, 321].

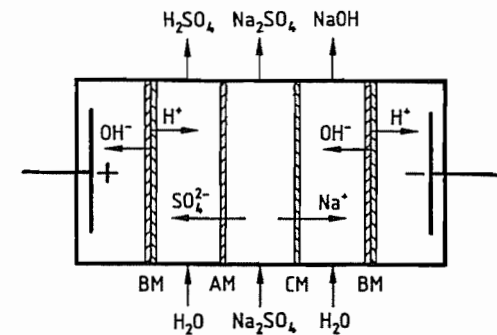

Figure 51.45: Electro-dialysis of sodium sulfate with bipolar membranes.

A development by Allied Signal of electro-dialysis with bipolar membranes is of interest due to the low energy consumption [322–325]. In these bipolar membranes (BM), a cation-exchange membrane is bonded to an anion-exchange membrane [326]. Water molecules diffuse to the phase boundary CM-AM, where they dissociate in the electric field. The  $H^+$  and  $OH^-$  ions diffuse in opposite directions. If the bipolar membranes are combined with CM and AM, as shown in Figure 51.45, the sulfate can be decomposed without the formation of hydrogen and oxygen. A large number of individual BM-AM-CM elements can be fitted between the two end electrodes. Decomposition of  $H_2O$  at the electrodes is then negligible. The only energy required is the dissociation energy of the water (0.022 kWh/mol). Laboratory investigations showed

an energy consumption of 1450–1700 kWh/t  $NaOH$  when 12–16% sodium hydroxide and 5–10% sulfuric acid are produced. Allied Signal supplies cells for pilot- and full-scale operation.

### Conversion Processes

**Metathesis with Hydrogen Chloride.** Owing to the high cost of electricity in the sodium sulfate electrolysis process, early attempts were made to bring about metathesis with hydrogen chloride:

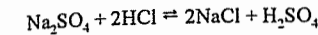

If the reaction is carried out in 40–60% sulfuric acid, sodium chloride precipitates and can be obtained in 99.2% yield (with 40%  $H_2SO_4$  at 30 °C) [228, 275, 327–329]. The concentrations must be such that enough  $HCl$  is taken up by the reaction mixture. A stoichiometric amount of  $HCl$  is sufficient for the reaction to proceed. Of this, approximately one-third distills off during the process, and must be recycled to the reactor.

The sodium chloride obtained can be used for the chlor-alkali electrolytic process [328]. The 40–60% sulfuric acid produced in the industrial process contains 1–2% residual  $Na_2SO_4$  [328] and is preferably recycled to the process in which the sodium sulfate is formed or used for reactions with sodium compounds, such as the production of chlorine dioxide from sodium chlorate, whereby  $Na_2SO_4$  is reacted continuously with  $HCl$  in a decantation-washing column [330].

Table 51.25: Use of sodium sulfate for reduction processes.

| Process   | Reaction   | References          |
|---|--|---------------------|
| Le Blanc process                                      | $Na_2SO_4 + 2C + CaCO_3 \rightarrow Na_2CO_3 + CaS + 2CO_2$  | [228, 234, 339]     |
| Production of sodium sulfide                          | $Na_2SO_4 + 2C \rightarrow Na_2S + 2CO_2$<br>$Na_2SO_4 + CH_4 \rightarrow Na_2S + CO_2 + 2H_2O$  | [228, 243, 340–343] |
| Production of aluminum oxide (Peniakoff process)      | $2Al_2O_3$ (bauxite) + $2Na_2SO_4 + C \rightarrow 4NaAlO_2 + 2SO_2 + CO_2$<br>$2NaAlO_2 + CO_2 + 3H_2O \rightarrow 2Al(OH)_3 + Na_2CO_3$ | [344–348]           |
| Digestion of phosphate rock for fertilizer production | $Ca_3(PO_4)_2 + 2Na_2SO_4 + 8C \rightarrow CaNa_4(PO_3S)_2 + 2CaO + 8CO$   | [349, 350]          |
| Production of sodium silicate (water glass)           | $2Na_2SO_4 + 2SiO_2 + C \rightarrow 2Na_2SiO_3 + 2SO_2 + CO_2$   | [228]               |

The metathesis of  $Na_2SO_4$  with  $HCl$  in dilute sulfuric acid was carried out in 1951 in a pilot plant [328].

Carrying out the metathesis at 800–900 °C in a melt allows pure sulfuric acid and pure sodium chloride to be obtained [331].

**Conversion to Potassium Sulfate.** The reaction

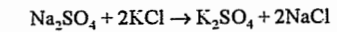

has been thoroughly investigated [228, 300, 332, 333]. It occurs in two stages: In the first stage, glaserite ( $Na_2SO_4 \cdot 3K_2SO_4$ ) is formed, which is decomposed by more potassium chloride to form  $K_2SO_4$  and  $NaCl$  in the second stage:

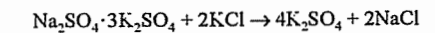

The reactions can be carried out at 20–40 °C. If Glauber's salt is used, temperatures of > 32 °C are preferred. In a modern plant,  $K_2SO_4$  yields of 98–99% are obtained [334, 335]. The reaction crystallization process is carried out in a loop-type bubble column [336].

The process has been operated since 1984 in a Russian plant that consumes 40 000 t/a  $Na_2SO_4$ . The Potash Corporation of Saskatchewan (PCS) has operated an experimental plant since 1985 in Cory, Canada, with a consumption of 25 000 t/a  $Na_2SO_4$  [243, 335].

Single-stage processes for carrying out this reaction have been proposed [337, 338].

### Reduction Processes

Sodium sulfate can also be used in reductive processes (Table 51.25).

**Table 51.26:** Consumption of sodium sulfate in 1987 (in  $10^3$  t/a).

| Use                         | Consumption                |               | References      |
|-----------------------------|----------------------------|---------------|-----------------|
|                             | Western world <sup>a</sup> | United States |                 |
| Cellulose industry          | 714                        | 271           | [243, 351, 352] |
| Glass production and others | 456                        | 128           | [243, 353]      |
| Detergents                  | 1736                       | 354           | [243, 354]      |

<sup>a</sup>Including United States.

### 51.16.1.5 Uses

World consumption of sodium sulfate in 1987 was ca.  $4.6 \times 10^6$  t [243].

The most important consumers were the cellulose-fiber industry and manufacturers of glass and detergents (Table 51.26).

Other users are from a wide range of industries [225, 243], including dyeing technology [355], electrochemical metal treatment [356], animal feeds [225], heat accumulators [243], and sponge manufacture [243].

### 51.16.1.6 Occupational Health and Environmental Protection

Sodium sulfate is a permitted food additive [357] and is a common component of spa waters [225].

Inhalation of sodium sulfate dust causes irritation of the mucous membranes, and prolonged skin contact has a drying effect. The laxative effect of oral ingestion is well known and is used medicinally.

Sodium sulfate in wastewater can be recovered as thenardite. However, if the solutions are very dilute ( $< 5\%$   $\text{Na}_2\text{SO}_4$ ), the crystallization process is energy intensive. In such cases, treatment of the wastewater by a membrane process [358], a precipitation process [359], or by biochemical methods [259] can be considered.

### 51.16.1.7 Economic Aspects

Demand for sodium sulfate in the Western industrialized nations has decreased during the last decade, but further reduction is ex-

pected to be balanced by increasing consumption in other parts of the world. The cellulose and glass industries and detergent manufacture account for ca. 80% of the sodium sulfate consumed. Environmental regulations have a great influence on the market for sodium sulfate, affecting both its production and its consumption. Owing to the large natural reserves of sulfate and the large quantities produced as a by-product of the chemical industry, prices are not expected to increase greatly. The most important producing countries in 1988 were the United States 16%; the Soviet Union 14%; Spain 13%; Mexico 10%; Canada 7%; Japan 6%; and Belgium 6%. The remaining 28% came from a number of sources [243].

### 51.16.2 Sodium Hydrogensulfate

Sodium hydrogensulfate [360] occurs as the monohydrate,  $\text{NaHSO}_4 \cdot \text{H}_2\text{O}$ , in the system sodium sulfate-sulfuric acid-water [238, 241] or exists as the solid phase  $\text{NaHSO}_4$  at a sulfuric acid concentration of 62%. The monohydrate is converted to the anhydrous salt at  $58.45 \pm 0.05$  °C.

The thermal decomposition represented by the equation

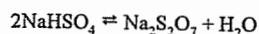

takes place near the melting point, which can be determined only approximately (ca. 183 °C) with a water vapor pressure of 2500 Pa (25 mbar). Conversion to sodium disulfate is complete after heating for ca. 4 h at 240–260 °C. Sodium disulfate decomposes above 400 °C to form sodium sulfate with liberation of sulfur trioxide.

**Production.** Sodium hydrogensulfate is formed as an intermediate in the production of hydrochloric acid by the Mannheim process (Section 1.3.4) and is a by-product of the manufacture of chromium(VI) oxide [274, 279, 286, 361]. The reaction between sulfuric acid and sodium chloride may be carried out by the old process using cast iron retorts heated with gas or oil, or by the use of submerged combustion equipment in brick-lined vessels [305, 362]. The addition of a stoichiometric amount

of sulfuric acid to sodium sulfate or Glauber's salt at 200–280 °C produces molten sodium hydrogensulfate [363]. The same reaction can be utilized to produce sodium hydrogensulfate in aqueous solution at 80 °C directly [363].

**Uses.** Sodium hydrogensulfate is used in the manufacture of household cleaners, in the textile industry, for the regeneration of rubber, for metal surface treatment, and as a flux for low-melting metals and their alloys [225].

### 51.17 Sodium Benzoate

$\text{C}_7\text{H}_5\text{O}_2\text{Na}$ , white granules or powder of sweetish taste. Between 0 and 50 °C the solubility in water is nearly constant, but at higher temperatures it increases sharply. At  $-13.5$  °C, the eutectic mixture with water consists of 44.9 g of the salt and 100 g of water. The densities of the aqueous solutions at various concentrations are given in Table 51.27. The aqueous solution is slightly alkaline (pH ca. 8). Sodium benzoate is soluble to the extent of 0.8 g in 100 mL of ethanol, 8.2 g in 100 mL of methanol, and over 20 g in 100 mL of ethylene glycol.

**Table 51.27:** Densities of aqueous sodium benzoate solutions at 20 °C.

| Concentration, % | Density, g/cm <sup>3</sup> |
|------------------|----------------------------|
| 22.0             | 1.09                       |
| 24.53            | 1.1                        |
| 26.84            | 1.11                       |
| 29.0             | 1.12                       |
| 31.06            | 1.13                       |
| 33.14            | 1.14                       |
| 35.3             | 1.15                       |
| 36.7 (saturated) | 1.154                      |

Dry sodium benzoate is electrically charged by friction and forms an explosive mixture when its dust is dispersed in air. It absorbs moisture from the air to some extent.

Upon heating in an inert atmosphere sodium benzoate carbonizes and forms sodium carbonate. In the presence of air, it burns to give carbon dioxide and sodium carbonate. Chlorination of sodium benzoate gives rise to a complex mixture of the salts of chlorobenzoic acids. Sodium benzoate reacts with benzoyl chloride to form benzoic anhydride.

Other salts of benzoic acid can be prepared by metathesis reactions with the salts of particular cations. The aqueous and alcoholic solutions of sodium benzoate possess a remarkable ability to passivate the surfaces of metals and alloys.

Sodium benzoate is produced by the neutralization of benzoic acid with sodium hydroxide. Direct oxidation of toluene in sodium hydroxide solution is not currently in use. The other production methods include the hydrolysis of benzoic esters or benzonitrile. Purification is essential to the production of high-purity product.

Table 51.28 shows the specifications required in Japan by JP 10 for sodium benzoate used as a food additive. The FAO and WHO limit some additional items which are not mentioned in Table 51.28. These include readily oxidizable substances, readily carbonizable substances, polycyclic acids, organic chlorine compounds, and lead.

The principal use of sodium benzoate is as an anticorrosive. The expansion of the motor industry has increased the demand for it. It is added mainly to antifreeze coolants. Sodium benzoate is also used in food preservatives. In the pharmaceutical field, it is used as a diagnostic reagent for liver functions. It is also used in combination with caffeine as a nerve stimulant.

**Table 51.28:** Specifications for high-purity sodium benzoate (Japanese document JP 10).

|                       |  |
|-----------------------|--|
| Assay                 | min. 99%   |
| Appearance            | white granules or powder, odorless                   |
| Solubility            | pass test  |
| Free alkaline         | max. 0.04% as NaOH                                   |
| Chlorine compounds    | max. 0.085% <sup>a</sup>                             |
| Sulfate               | max. 0.12% as $\text{SO}_4$                          |
| Phthalate             | pass test  |
| Arsenic               | max. 4 mg/kg as $\text{As}_2\text{O}_3$ <sup>b</sup> |
| Heavy metals          | max. 20 mg/kg  |
| Weight loss at 110 °C | max. 1% <sup>c</sup>                                 |

<sup>a</sup>Food Chemicals Codex (USA) max. 0.07.<sup>b</sup>FAO/WHO max. 3 mg/kg.<sup>c</sup>FAO/WHO max. 1.5%.

### 51.18 References

1. Kirk-Othmer, 3rd ed., 21, p. 181.



2. Hofmann, Rüdorff: *Anorganische Chemie*, 21st ed., Vieweg & Sohn, Braunschweig 1973, p. 420.
3. C. Berger, H. Fickenferichs, R. Peper, W. Jansen: *Prax. Naturwiss. Chem.* 40 (1991) no. 6, 2.
4. M. Sittig: *Sodium, its Manufacture, Properties and Uses*, Reinhold Publ. Co., New York 1956, pp. 1-9.
5. *Winnacker-Küchler*, 4th ed., 4, p. 326.
6. H. Y. Castner, US 452030, 1891.
7. Rößler & Haßlacher Chem. Co., US 1501756, 1921 (J. C. Downs).
8. H. U. Borgstedt, C. K. Mathews: *Applied Chemistry of the Alkali Metals*, Plenum Press, New York 1987.
9. N. N. Greenwood, A. Earnshaw: *Chemie der Elemente*, 1st ed., Verlag Chemie, Weinheim 1988, pp. 97.
10. *Ullmann*, 4th ed., 17, p. 143.
11. Degussa, Geschäftsbereich Chemie: Natrium, Eigenschaften, Handhabung, Anwendung, Company brochure, Ch 621-0-2-1089H, Hanau.
12. G. Dittrich, H. Offermanns, H. Schlosser, Jr., *ChET Chem. Exp. Technol.* 3 (1977) 151-162.
13. "The Alkali Metals", *Mellor's Comprehensive Treatise on Inorganic and Theoretical Chemistry*, vol. 2, suppl. 2, part 1, Longmans, London 1961.
14. Linus Pauling: *Chemie, Eine Einführung*, 7th ed., Verlag Chemie, Weinheim 1967.
15. P. Caubère, *Angew. Chem.* 95 (1983) 597-611.
16. Degussa, Geschäftsbereich Chemie: Natriumhydrid, Eigenschaften, Reaktionen, Anwendung, Company brochure, C 25-0-1-772 Vol, Hanau.
17. O.-A. Neumüller: *Römpps Chemie-Lexikon*, 8th ed., Franck'sche Verlagsbuchhandlung, Stuttgart 1985.
18. A. Klemenc, E. Svetlik, *Z. Anorg. Allg. Chem.* 269 (1952) 153.
19. K. M. Myles, F. A. Cafasso, *J. Nucl. Mater.* 67 (1977) 249-253.
20. *Ullmann*, 3rd ed., 17, p. 415.
21. J. J. Chydenius *Ann. Phys. (Leipzig)* 2 (1863) no. 119, 43-56.
22. W. v. Bolton, *Z. Elektrochem. Angew. Phys. Chem.* 14 (1908) 768-770.
23. D. Lely, Jr., L. Hamburger, *Z. Anorg. Chem.* 87 (1914) 209-228.
24. L. F. Nilson, *Ber. Dtsch. Chem. Ges.* 15 (1882) 2537-2547.
25. *Ullmann*, 4th ed., 17, p. 711.
26. N. Korber, W. Assenmacher, M. Jansen, *Prax. Naturwiss. Chem.* 40 (1991) no. 6, 18.
27. U. Deschler, P. Kleinschmit, P. Panster, *Angew. Chem.* 98 (1986) 237-253.
28. A. Streitwieser, C. H. Heathcock, *Organische Chemie*, Verlag Chemie, Weinheim 1980, pp. 192-194.
29. F. A. Cotton, G. Wilkinson: *Advanced Inorganic Chemistry*, 4th ed., John Wiley & Sons, New York 1980.
30. National Distillers and Chem. Corp.: *Sodium Monography*, Company brochure, New York.
31. *Winnacker-Küchler*, 3rd ed., 6, 81.
32. Nippon Soda, JP 59050021, 1982.
33. The Dow Chemical Comp., US 3265492, 1963 (P. R. Juckniess).
34. Ethyl Corp., US 2660517, 1952 (F. L. Padgitt).
35. R. E. Hulse, US 2130801, 1938.
36. Ethyl Corp., US 2944950, 1957 (G. O. Hayes).
37. Du Pont, US 3037927, 1962 (C. T. Gallinger).
38. J. S. Honea, US 2770364, 1956.
39. Ethyl Corp., US 2770592, 1956 (A. L. Feutress).
40. Olin Mathieson Chem. Corp., US 3085967, 1960 (G. T. Motock).
41. Ethyl Corp., US 2755244, 1952 (C. C. Harvey).
42. Du Pont, US 2921894, 1957 (T. O. Callaghan).
43. Du Pont, US 3544444, 1967 (V. J. Reilly).
44. Du Pont, US 4376028, 1981 (R. D. Marczewski, F. J. Ross).
45. Du Pont, US 3118827, 1961 (S. E. Eckert, F. J. Ross).
46. ICI, US 2861938, 1955 (R. D. Glascodine).
47. Ethyl Corp., US 3463721, 1967 (L. L. Harris).
48. Du Pont, US 4305671, 1980 (F. J. Ross).
49. Du Pont, FR 1567424, 1967 (C. T. Gallinger).
50. Du Pont, US 4092228, 1977 (F. J. Ross).
51. S. Crowther, US 3776823, 1967.
52. National Distillers and Chem. Corp., US 2913381, 1967 (W. F. McFadyen, C. E. Buterbaugh).
53. K. A. Ruppert, Degussa AG, Company information, Frankfurt/Main 1992.
54. K. H. Meier, Degussa, Company report, Frankfurt/Main 1992.
55. M. A. Bredig in M. Blander (ed.): *Molten Salt Chemistry*, Interscience, New York 1964, pp. 367-425.
56. N. H. Nachtrieb in J. Prigogine, S. A. Rice (eds.): *Advances in Chemical Physics*, vol. 31, John Wiley, New York 1975, pp. 465-480.
57. Du Pont, US 3558451, 1971 (R. E. Svadlenak).
58. Du Pont, US 3560353, 1971.
59. Du Pont, US 4139428, 1979 (A. J. Dean, F. J. Ross).
60. Ford Motor Co., US 3488271, 1966 (J. T. Kummer, N. Weber).
61. Du Pont, US 4203819, 1978 (S. A. Cope).
62. Du Pont, US 4133728, 1978 (S. A. Cope).
63. Du Pont, US 4089770, 1977 (C. H. Lemke).
64. ICI, US 3607684, 1967 (A. T. Kuhn).
65. F. Huber, P. Menzenhauer, W. Pepler, W. Tell: "Untersuchung des Brandverhaltens von flüssigem Natrium", *KFK Nachr.* 4 (1972) no. 3, 9-13.
66. F. Huber, P. Menzenhauer, W. Pepler, W. Till, Verhalten von Natrium-Bränden und Erprobung von Schutzsystemen, KFK-1970, Kernforschungszentrum Karlsruhe, April 1974.
67. W. Cherdron: *Jahrestagung Kerntechnik 1989*, Düsseldorf, p. 231.
68. W. Cherdron, W. Schütz: *Jahrestagung Kerntechnik 1993*, Köln.
69. P. Menzenhauer, G. Ochs, W. Pepler, Erprobung eines Löschpulvers auf der Basis von Graphit für Flüssigmetallbrände, KFK-2525, Kernforschungszentrum Karlsruhe, Nov. 1977.
70. F. Huber, P. Menzenhauer, W. Till, *KFK-1970*, Kernforschungszentrum Karlsruhe, April 1974.
71. W. Cherdron, S. Jordan, W. Lindner, *KFK-4358*, Kernforschungszentrum Karlsruhe, Nov. 1990.
72. S. Jordan et al., *Nuclear Technol.* 81 (1988) no. 2, 183.
73. P. Menzenhauer et al., "Experience with Cleaning of Sodium-Wetted Components and Decontamination at Nuclear Research Centre Karlsruhe", *IAEA Meeting on Sodium Removal and Decontamination*, Richland, WA, Aug. 1978, pp. 30-37.

74. E. Bilger, L. Lange, *Prax. Naturwiss. Chem.* 40 (1991) no. 6, 12.
75. J. F. Cordes, *Chem. Unserer Zeit* 3 (1977) no. 11, 65.
76. H. Pommer, *Angew. Chem.* 89 (1977) 437-443.
77. K. W. Stoffregen, Fa. Dr. Riedelbauch & Stoffregen GmbH, Company report, Meisenheim/Glau.
78. A. Pacz, DT 117773, 1925.
79. E. Dunkel, *Gießerei* 58 (1971) no. 24, 782.
80. Metallgesellschaft, "Silumin, die Al-Gußlegierung", Company brochure, Frankfurt/Main.
81. G. Gürtler, *Z. Metallk.* 44 (1953) 503.
82. S. Justi, K. Körber, K. Löhberg, *Gießereiforschung* 24 (1972) no. 1, 37-44.
83. R. Irmann: *Aluminium in Sand und Kokille*, Aluminium Verlag, Düsseldorf 1953, p. 104.
84. Asea Brown Boveri AG, "Hochenergiebatterie und Elektroauto", Company brochure no. DHB 1310881 (1987), DHB 1253871 (1988), Heidelberg.
85. F. Beck, *Chem. Ing. Tech.* 54 (1982) no. 9, 809-817.
86. W. Fischer, F. J. Rohr, *Chem. Ing. Tech.* 50 (1978) no. 4, 303-305.
87. H. U. Borgstedt, G. Frees, *Werkst. Korros.* 38 (1987) 725-737.
88. K. Förster, G. Ruloff: "Flüssigmetalle als Wärmeübertragungsmittel", CAV, Konradin Verlag, Leinfelden-Echterdingen 1988, p. 182.
89. H. U. Borgstedt, C. Guminski, *Metals in Liquid Alkali Metals*, IUPAC Solubility Data Series, in press.
90. O. J. Foust: *Sodium Na-K, Engineering Handbook*, Gordon & Breach, New York 1972.
91. C. Hirayama, Z. Galus, C. Guminsky, "Metals in Mercury", in A. S. Kertes (ed.): *Solubility Data Series*, vol. 25, International Union of Pure and Applied Chemistry, in press.
92. H. Hund, F. R. Minz in H. Harnisch, R. Steiner, K. Winnacker (eds.): *Chemische Technologie*, 4th ed., vol. 2, Carl Hanser Verlag, München 1982, p. 400.
93. Kernforschungszentrum Karlsruhe, DE 4034137 C1, 1990 (H. U. Borgstedt).
94. E. Hermann: *Handbuch des Stranggießens*, Aluminium Verlag, Düsseldorf 1958, pp. 764-765.
95. Metall Invent S.A., DT 2457423, 1974.
96. Unilever, GB 1236233, 1968 (W. H. De Groot, M. H. Hilder).
97. Degussa AG, DE 3016173, 1980 (W. Hinrichs et al.).
98. R. Neureiter, Degussa AG, Company report, Frankfurt/Main 1992.
99. Métaux spéciaux S.A. Paris, DT 2454051, 1974 (B. Batoux, A. Laurent-Atthalin, M. Salmon).
100. Métaux spéciaux S.A., "Sodium", Company brochure, 92087 Paris la Défense, Frankreich.
101. O. Pfeffer: Berufsgenossenschaft der chemischen Industrie, Merkblatt Natrium, M 019,5/84, Jedermann-Verlag, Heidelberg 1984.
102. Du Pont, Sodium Data Sheet, Chemical Safety Data Sheet, Wilmington, Delaware 1989 SD-47, Sodium, Manufacturing Chemists Association, Washington, DC, 1978.
103. A. Huber: "Sodium (Metal)-United States", (E. H. Data Summary, Chemical Information Services, Stanford Research Institute, CA, 1990).
104. G. Busch: "Sodium Makers Adjust to Changing Market Place", *Chem. Mark. Rep.* 240 (1991) 27.
105. W. Botsch: *Salz des Lebens*, Kosmos Gesellschaft der Naturfreunde, Franck'sche Verlagshandlung, Stuttgart 1976.
106. H. Seidel, R. Woller: *Das Geschenk der Erde*, ECON Verlag, Düsseldorf 1980.
107. M. J. Schleiden: *Das Salz, seine Geschichte, seine Symbolik und seine Bedeutung im Menschenleben*, Verlag Wilhelm Engelmann, Leipzig 1875.
108. S. Falkenberg: *Salz ist Leben, seine Bedeutung für Ihre Gesundheit*, Ariston Verlag, Genf 1987.
109. P. Meier: *Die Würze des Lebens, Salz*, Schweizer Verlagshaus, Zürich 1983.
110. J. F. Bergier: *Die Geschichte vom Salz*, Campus Verlag, Frankfurt-New York 1989.
111. W. Kaufmann: *Sodium Chloride*, Reinhold Publ. Co., New York 1960, pp. 587ff.
112. *J. Phys. Chem. Ref. Data* 11 (1982) 15-81; 13 (1984) 1-102. *Gmelin* 8th ed., System No. 21, pp. 309ff. *Landolt-Börnstein*, 6th ed., 2, part 8, 46ff.
113. Te-Pang Hou: *Manufacture of Soda*, Reinhold Publ. Co., New York 1942, p. 118.
114. S. K. Coburn, *Corrosion* 10 (1954) no. 5, 1.
115. W. W. Bradley, *Corrosion (Houston)* 11 (1955) 383.
116. DECHEMA-Werkstofftabelle, Blatt Nr. DWT 1043ff, 3. Bearbeitung, DECHEMA, Frankfurt/Main 1962.
117. S. T. Lefond: *Handbook of World Salt Resources*, Plenum Press, New York 1969.
118. G. Spackeler: *Lehrbuch des Kali- und Steinsalzbergbaues*, VEB Wilhelm Knapp Verlag, Halle (Saale) 1957, pp. 243-254.
119. H. Jendersie: *Kali- und Steinsalzbergbau*, vol. 2, VEB Deutscher Verlag für Grundstoffindustrie, Leipzig 1969, pp. 150-154.
120. G. Brückner, *Freiberger. Forschungh. A418* (1967) 11-46.
121. G. Brückner, *Bergakademie* 10 (1961) 625-629.
122. P. Ambatiello, *5th Symp. on Salt*, vol. 2, The North, Ohio Geol. Soc. Corp., Cleveland, OH, 1978, pp. 213-218.
123. K. Thomanek, *5th Symp. on Salt*, vol. 2, The North, Ohio Geol. Soc. Corp., Cleveland, OH, 1978, pp. 171-182.
124. P. Ambatiello, *Glückauf* 118 (1982) 1183-1188.
125. G. Dorstewitz, C. H. Fritzsche, H. Prause, *Glückauf* 95 (1959) 1245-1250.
126. P. Ambatiello, *Felsbau* 8 (1990) 180-184.
127. G. Feder, M. Hoscher, *Felsbau* 5 (1987) 114-149.
128. K. Thomanek, *BHM Berg Hüttenmänn. Monatsh.* 127 (1982) 381-389.
129. M. Hoscher, *BHM Berg Hüttenmänn. Monatsh.* 126 (1981) 234-238.
130. K. Schmidt, *Tech. Mitt.* 68 (1975) 363-368.
131. H. Gomm, J. Hieblinger, G. Kühn, *Erdöl Erdgas Z.* 93 (1977) 83-90.
132. H. K. Röhr, *Erdöl Kohle Erdgas Petrochem.* 22 (1969) 670-679, 734-741.
133. S. Meister, G. Kuhr, *Erdöl Erdgas Z.* 88 (1972) 248-257.
134. H. Borchert, W. Dreyer: Gutachten über die Standfestigkeit und Konvergenz von Kavernen im Salzstock, Mineralog.-petrograph. Inst. d. TU Clausthal, 10 Dec. 1967.
135. W. Dreyer, *Kali Steinsalz*: 5 (1971) 473-478.

136. S. Serata: "Continuum Theory and Model of Rock Salt Structures", 2nd Symp. on Salt, Northern Ohio Geol. Soc., Cleveland 1965.
137. R. W. Durie, F. W. Jessen, *Soc. Pet. Eng. J.* **1964** 183-190.
138. W. Dreyer: *Gebirgsmechanik im Salz*, Enke Verlag, Stuttgart 1974.
139. K.-H. Lux: *Gebirgsmechanischer Entwurf und Felderfahrungen im Salzkavernenbau*, Enke Verlag, Stuttgart 1984.
140. F. Schober, A. Sroka: "Die Berechnung von Bodenbewegungen über Kavernen unter Berücksichtigung des zeitlichen Konvergenz- und Gebirgsverhaltens", *Kali Steinsalz* **8** (1983) March, no. 10.
141. A. Sroka, F. Schobor: "Die Berechnung der maximalen Bodenbewegungen über kavernenartigen Hohlräumen unter Berücksichtigung der Hohlraumgeometrie", *Kali Steinsalz* **8** (1972) Aug., no. 8.
142. A. Sroka: "Abschätzung einiger zeitlicher Prozesse im Gebirge", Schriftenreihe Lagerstättenerfassung und -darstellung, Bodenbewegungen und Bergschäden Ingenieurvermessung Kolloquium, Leoben, 15-16 Nov. 1984.
143. A. Sroka, A. Hartmann: "Die Überwachung von Speicherkavernen mittels geodätischer und physikalischer Beobachtungen", Proceedings 5th. International Congress, International Society of Mine Surveying Harrogate, 9-13 Sept. 1985.
144. H. von Schonfeldt, L. Remoline in A. H. Coogan (ed.): "Mechanism of Solution and Cavity Control in a Two-Well-System with Emphasis on Jetting", 4th Symp. on Salt, Northern Ohio Geol. Soc. Inc., Cleveland 1974, pp. 189-202.
145. K. Henderson: "Methods of Joining Two or More Wells for Brine Production", in [144], pp. 211-218.
146. H. Rischmüller, *Erdöl Erdgas Z.* **88** (1972) 240-248.
147. H. G. Haddenhorst et al., *Erdöl Erdgas Z.* **90** (1974) 154-161, 197-204.
148. H. Bresson, *Rev. fr. énerg.* **26** (1969) 527-543.
149. M. Klafki, H.-J. Kretzschmar, W. Menzel, W. Schreiner: "Aussolung von Gasspeicher-Kavernen in mächtigen Salzlagerstätten", *Neue Bergbautech.* **20** (1991) March, no. 3.
150. E. F. Armstrong, L. M. Miall: *Raw Materials from the Sea*, Chemical Publishing Co., Brooklyn 1946.
151. Compagnie des Salins du Midi et des Salines de l'Est (C.S.M.E.): *Le Sel*, Presses universitaires de France, Paris.
152. Laboratoire C.S.M.E., Aigues-Mortes, France, personal communication.
153. Central Research Institute, Japan Monopoly Corporation, Figures for Salt Production, Tokyo 1954.
154. D. W. Kaufmann: *Sodium Chloride*, Reinhold Publ. Co., New York 1960.
155. *Ullmann*, 3rd ed., **12**, 674.
156. J. v. Rozicky: in [144], vol. 2, p. 425.
157. Escher-Wyss-Mitteilung 1961/2-3; 1975/2.
158. C. M. vant Land, K. J. A. de Waal: *Industrial Crystallisation*, J. W. Mullin, New York 1976, pp. 449ff.
159. C. M. vant Land, B. G. Wienk: *Industrial Crystallisation*, J. W. Mullin, New York 1976, pp. 51ff.
160. L. J. Theilgard, 1st Symposium on Salt, Northern Ohio Geol. Soc. Inc., Cleveland, OH, 1963, pp. 417ff.
161. M. A. van Damme et al.: *Influence of Additives on the Growth and Dissolution of Sodium Chloride Crystals*, Drukkerij Smit, Hengelo 1965.
162. E. G. Cooke in [136], vol. 1, p. 259.
163. Salt Institute, Recent successes and Failures in Combating Corrosion in Salt Plants, Seminar Chicago, Ill. June 1977.
164. Verein Deutsche Salzindustrie e.V. (VDS): *Salz III - Ein Nahrungsmittel*, Hanser Verlag, München 1985, pp. 17ff.
165. G. Reimer, Ch. Thieme, *Natriumchlorid*, Hanser Verlag, München 1982, pp. 492-494.
166. VDS: *Salz I - Geschichte und Bedeutung*, Hanser Verlag, München 1983, p. 64.
167. VDS: *Salz V - In der Wasserenthärtung*, Hanser Verlag, München 1989, pp. 37ff.
168. W. Botsch: *Salz des Lebens*, Franckh'sche Verlags-handlung, Stuttgart 1976, pp. 69ff.
169. VDS: *Salz II - Rohstoff in der Chemie*, Hanser Verlag, München 1984, pp. 36-38.
170. Deutsche Solvay Werke GmbH: *Das Salz der Chemie*, Solingen 1983, pp. 28-29.
171. VDS: *Salz IV - Im Winterdienst*, Hanser Verlag, München 1985, pp. 10-15.
172. S. U. Pickering, *J. Chem. Soc.* **63** (1893) 890.
173. *Gmelin*, 8th ed., System no. 21.
174. H. S. Burney, J. B. Talbot, *J. Electrochem. Soc.* **138** (1991) 3140-3169.
175. Harriman report (1996) 03/1995, Tecnon Ltd., London.
176. R. Winkler, *Chem. Ind.* **36** (1984) 152-155.
177. S. A. McCluney, J. W. Van Zee, *J. Electrochem. Soc.* **136** (1989) 2556-2564.
178. C. B. Kelly, I. L. Walker, Staff of the Chlorine Institute, Inc. (eds.): *The Second Chlor-Alkali Symposium, World Chlor-Alkali. An Industry in Transition, Proceedings*, Washington, DC, 1990.
179. D. C. Brandt, paper presented at the Chlorine Institute Meeting, Washington, DC, April 1989.
180. M. Kamaludeen et al., *Transactions of the SAEST* **21** (1986) no. 1, 53-56.
181. B. A. Friedfeld in T. C. Wellington (ed.): *Modern Chlor Alkali Technology*, vol. 5, Elsevier, London 1992, pp. 1-12.
182. J. Young, *Chem. Week* **150** (1991) Oct. 2, 14.
183. *Ullmann*, 3rd ed., **12**, pp. 659-660.
184. S. Sridhar, *Chem. Ing. Tech.* **61** (1989) 428-429.
185. H. v. Plessen et al., *Chem. Ing. Tech.* **61** (1989) 933-940.
186. G. Kreysa, *Chem. Ing. Tech.* **62** (1990) 357-365.
187. J. Jörissen, K. H. Simmrock, *J. Appl. Electrochem.* **21** (1991) 869-876.
188. G. Venkoba, Rao, *IPPTA* **24** (1987) no. 3, 20-29.
189. I. K. Nelson in B. J. Moniz, W. I. Pollock (eds.): *Process Industries Corrosion*, NACE, Houston, TX, 1986.
190. CSD, PPG Industries, Company Brochure, Pittsburgh, PA.
191. *Ullmann*, 4th ed., **17**, p. 206.
192. Tecnon Market Analysis, Caustic Soda into the 1990s, London 1990.
193. *Chem. Bus.* **1989**, Dec., 24-25.
194. *International Critical Tables*, vol. III, p. 372. vol. IV, pp. 237, 259, McGraw-Hill, New York 1928.

195. L. Lortie, P. Demers, *Canadian J. Res.* **18** (B) (1940) 164.
196. A. F. Newkirk, J. Aliferis, *Anal. Chem.* **30** (1958) 982-984.
197. W. L. W. Ludekens, T. Thirunamachandran, *Chem. Ind. (London)* **1954**, 1265-1266.
198. C. Kröger, E. Fingas, *Z. Anorg. Allgem. Chem.* **212** (1933) 257-268, 264.
199. F. Ishikawa, F. Murooka, H. Hagsawa, *Abstr. Rikawagaku-Kenhyu-jo Iho* **5** (1932) 23-24; *Sci. Rep. Tohoku Imp. Univ.* **22** (1933) 1179-1196.
200. E. G. Bunzel, E. J. Kohlmeier, *Z. Anorg. Allgem. Chem.* **254** (1947) 1-30.
201. Te-Pang Hou: *Manufacture of Soda*, 2nd ed., Reinhold Publishing Corp., New York 1942, p. 17.
202. P. P. Fedodief, *Z. Anorg. Chem.* **17** (1904) 1644-1659.
203. E. Jänecke, *Z. Angew. Chem.* **20** (1907) 1559-1564.
204. Z. Rant: *Die Erzeugung von Soda nach dem Solvay Verfahren*, F. Enke Verlag, Stuttgart 1968, pp. 76-83, 125-160.
205. H. Börger, *Bergbau Rundschau* **4** (1952) 84-88.
206. M. Imamura, *Ind. Eng. Chem.* **54** (1962) no. 2, 35-39.
207. United Nations Economic and Social Council, *ECE/CHEM* **14** (1976) Sept. 20, p. 5.
208. *The Economics of Soda Ash*, 6th ed., Roskill Information Services, London 1991.
209. B. M. Coope, P. W. Harben: "Soda Ash", in P. W. Harben (ed.): *Raw Materials for the Glass Industry*, Industrial Minerals Consumer Survey, 1977.
210. *Ind. Chem.* **31** (1955) no. 370, 547.
211. *Ind. Min.* **1975**, no. 96, Sept., 23-27.
212. N. L. Talmud, *Khim. Promst. Moscow* **1961**, 226-232.
213. *Ullmann*, 3rd ed. **12**, p. 656.
214. *Winnacker-Küchler*, 2nd ed., **1**, pp. 210-213.
215. E. Stiers, DE-OS 1592039, 1967.
216. S. Lynn et al., US 3792153, 1972.
217. R. Blumberg, J. E. Gai, K. Hajdu, *Proceedings International Solvent Extraction Conference 1947*, vol. 3, pp. 2789-2802, Soc. Chem. Ind., London 1974.
218. Israel Mining Industries Institute for Research and Development, Israel, IL 33552, 1969.
219. E. Pischinger, St. Bursa, H. Koneczny, J. Straszko, *Przem. Chem.* **54** (1975) 593-594.
220. F. Meinck, H. Stooff, H. Kohlschütter: *Industrie-Abwasser*, G. Fischer-Verlag, Stuttgart 1968, pp. 245-248.
221. Industrial Minerals Glass Survey 1977, pp. 39-49.
222. *Gmelin*, 8th ed. System no. 21, pp. 764-766, 1358-1363.
223. A. E. Hill, L. R. Bacon, *J. Am. Chem. Soc.* **49** (1927) 2487.
224. J. F. Henkels: *Pyritologia oder Kieshistorie*, Großische Handlung, Leipzig 1754, p. 705.
225. *Ullmann*, 4th ed., **17**, 211-229.
226. G. Lunge: *Handbuch der Soda-Industrie*, 3rd ed., vol. 2, Vieweg, Braunschweig 1909.
227. H. Furkert in F. Ebel (ed.): *Chemische Berichte*, Reichsamt für Wirtschaftsausbau, Berlin, January 1943, pp. 28-33.
228. H. v. Plessen et al., *Chem. Ing. Tech.* **61** (1989) 933-940.
229. Great Salt Lake Minerals and Chemicals Corp., US 3575688, 1969.
230. Mannesmann, DE-OS 3721667, 1987.
231. Intermountain Res. Dev. Corp., US 4519806, 1982.
232. Techemet, ZA 87/09599, 1987.
233. *Ullmann*, 4th ed., **13**, 450.
234. *Gmelin*, 8th ed., Natrium (1928).
235. *Gmelin*, 8th ed., Aun., Natrium, Erg.bd. (1964-1970).
236. In [235], part 3, 1117.
237. In [235], part 3, 1092-1095.
238. A. Seidell, W. F. Linke: *Solubilities of Inorganic and Metal-Organic Compounds*, 4th ed., vol. 2, American Chemical Society, Washington, DC, 1965, pp. 1121-1123.
239. H. Stephen, T. Stephen: *Solubilities of Inorganic and Organic Compounds*, vol. 1/1, Pergamon, London 1963, pp. 126-127.
240. A. Seidell: *Solubilities of Inorganic and Metal-Organic Compounds*, 3rd ed., vol. 1, Van Nostrand, New York 1940, pp. 1234-1235.
241. H. L. Silcock (ed.): *Solubilities of Inorganic and Organic Compounds*, vol. 3/2, Pergamon, Oxford 1979 pp. 827-848, 971-972.
242. R. E. Vener, A. R. Thompson, *Ind. Eng. Chem.* **41** (1949) 2242-2247; **42** (1950) 171-174.
243. *The Economics of Sodium Sulphate 1990*, 6th ed., Roskill Information Services, London 1990.
244. SRI International: *Chemical Economics Handbook*, May 1982, p. 771, 1000 G-T.
245. R. C. Kerr et al., *Nature (London)* **340** (1989) no. 6232, 357-362.
246. In [235], part 1, 231-234.
247. *Winnacker-Küchler*, 4th ed., **1-7**, 1981-1986.
248. In [247], **2**, 76-78.
249. Metallgesellschaft AG DE 1150368, 1960.
250. Standard-Messo, DE 1467244, 1963.
251. Standard-Messo, DE 1519911, 1965.
252. W. Linstaedt, G. Hofmann, *Chem. Ind. (Düsseldorf)* **31** (1979) 329-333.
253. R. J. King, *Chem. Eng. Prog.* **80** (1984) no. 7, 63-69.
254. D. J. Neville, *Cryst. Precip. Proc. Int. Symp.*, **1987**, pp. 109-116.
255. T. Messing, W. Wöhlk, *Chem. Ing. Tech.* **45** (1973), 106-109.
256. Metallgesellschaft AG, DE-OS 2904345, 1979.
257. Ebner & Co, DE-OS 2246568, 1972.
258. Standard-Messo, DE-OS 1519910, 1965.
259. R. Hürzeler, G. Stucki, *GWV Gas Wasserfach: Wasser Abwasser* **131** (1990) 231-244.
260. P. G. Rueffel: *Proc. 3rd Symp. Salt 1969* (Publ. 1970) p. 429-451.
261. Ebara Infilco, DE-AS 1567941, 1967.
262. Escher-Wyss, DE-OS 2543721, 1975.
263. Wintershall AG, DE-AS 2029984, 1970.
264. Multifibre Process, AT 355517, 1978.
265. W. Fleischmann, A. Mersmann, *Process Technol. Proc.* **1984**, no. 2 (Ind. Cryst.), pp. 165-170.
266. W. Fleischmann, A. Mersmann, *Chem. Ing. Tech.* **57** (1985) 178-179.
267. D. Lobley, K. L. Pinder, *Waste Treat. Util. Proc. Int. Symp.* **2nd** 1980 (Publ. 1982) pp. 63-70.

268. G. Mina-Mankarios, K. L. Pinder, *Can. J. Chem. Eng.* 69 (1991) 308-324.
269. M. R. Bhatt et al., *Res. Ind.* 37 (1992), no. 1, 34-35.
270. T. Kobayashi, *CEER Chem. Econ. Eng. Rev.* 8 (1976) no. 6, 42-48.
271. M. Driessen, *Br. Chem. Eng.* 15 (1970) 1154-1158.
272. Politechnika Szczecińska DD 265390, 1986.
273. *Chem. Abstr.* 107 (1987) 24670x.
274. Allied Chem. Corp., DE-OS 2151323, 1970.
275. Occidental Chem. Corp., US 5393503, 1991.
276. *Ullmann*, 4th ed., 23, 688.
277. Kema Nord AB, US 4678653, 1985.
278. Tenneco Canada, US 4780304, 1987.
279. Lundberg, US 4483740, 1983.
280. G. Gurato et al., *Chim. Ind. (Milan)* 69 (1987) no. 12, 140-147.
281. G. Gurato et al., *J. Cryst. Growth* 66 (1984) 621-631.
282. In [247], 6, 182-183.
283. E. M. Arnoldov et al., *Sov. Chem. Ind. (Engl. Transl.)* 11 (1979) 549-550.
284. Polioli, EP-OS 245719, 1986.
285. FIAT, Microfilm AA-216, Frames 8-15, 65-156 (PB. 73556).
286. J. B. Hunter, EP-OS 65412, 1981.
287. B. Asano, M. Olper, *Proc. 43rd Int. Waste Conf.* 1988 (Publ. 1989) 45-50.
288. R. M. Reynolds et al., *Proc. World Symp. Metall. Environ. Control 1990*, 119th TMS Annu. Meet., pp. 1001-1056.
289. *Ullmann*, 3rd ed., 11, 185-187.
290. Balcke-Dürr AG, EP-OS 301452, 1987.
291. Chemieanlagenbaukombinat Leipzig-Grimma, DD 293098, 1987.
292. Metallgesellschaft AG, DE-OS 3616508, 1986.
293. D. J. Wahl, *Umwelt* 20 (1990) no. 3, L4-L10.
294. S. Weiß, H. Wanko, *Chem. Tech. (Leipzig)* 43 (1991) 177-188.
295. In [235], part 1, 214-224.
296. G. Lesino et al., *Sol. Energy* 45 (1990) no. 4, 215-219.
297. W. A. MacWilliams, R. G. Reynolds, *CIM Can. Inst. Mining Met. Bull.* 66 (1973) no. 734, 115-119. Alberta Sulphate, CA 1007563, 1975.
298. P. L. Broughton, *Ind. Miner. (London)* 1977 no. 121, 51-59.
299. MINERSA, ES 504459, 1981.
300. O. K. Yanateva et al., *J. Appl. Chem. USSR (Engl. Transl.)* 52 (1979) 388-389.
301. Kerr-McGee Chem. Corp., US 4291002, 1977; US 4478599, 1982.
302. W. I. Weisman, *Chem. Eng. Prog.* 60 (1964) no. 11, 47-49.
303. P. Behrens, *Bull. Utah Geol. Min. Surv.* 1980, no. 116, 233-238.
304. *Chem. Ing. Tech.* 37 (1965) 666.
305. *Ullmann*, 3rd ed., 15, 71-73.
306. C. W. Cannon, US 2706145, 1955.
307. IG Farbenindustrie AG, DE 694409, 1936.
308. FIAT, Microfilm AA-216, Frames 174-188 (PB. 73556).
309. In [235], part 1, 228-229.
310. Morton Int., DE-AS 1293139, 1961.
311. *Winnacker-Küchler*, 3rd ed., 1, 150-151.
312. In [235], part 1, 227.
313. H. Picht, *Hung. J. Ind. Chem.* 17 (1989) no. 2, 179-183.
314. J. Jörissen et al., *DECHEMA-Monogr.* 124 (1991), 21-35.
315. J. Jörissen et al., *J. Appl. Electrochem.* 21 (1991) 869-876.
316. BASF, EP-OS 449071, 1990.
317. B. Pieper, *Fortschr. Ber. VDI Reihe 3* 132 (1987).
318. Imperial Chem. Ind., EP-OS 532188, 1991.
319. K. Tomiie, Y. Hayashi, *New Mater. New Processes Electrochem. Technol.* 1 (1981) 284-288.
320. H. Kau, *DECHEMA-Monogr.* 98 (1985) 291-298.
321. Lenzing AG, EP-OS 399993, 1989.
322. K. Nagasubramanian et al., *J. Membr. Sci.* 2 (1977) 109-124; 3 (1978) 71-83.
323. Allied Corp., US 4116889, 1978.
324. Allied Corp., US 4140815, 1979.
325. K. N. Mani et al., *Desalination* 68 (1988) 149-166.
326. H. Strathmann et al., *DECHEMA-Monogr.* 125 (1992) 83-100.
327. BASF, DE 868742, 1941.
328. C. F. Linström, *Chem. Tech. (Leipzig)* 4 (1952) 375-380.
329. K. Altenbach, Hoechst AG, personal communication, Frankfurt/Main 29.11.1991.
330. Erco Industries, DE-OS 2856504, 1978.
331. C. F. Hoppe, Dissertation Dortmund 1995, Aachen: Shaker Verlag, 1996.
332. *Gmelin*, 8th ed., Kalium, Erg.bd. (1970), 26-37.
333. H. Scherzberg et al., *Chem. Tech. (Heidelberg)* 20 (1991) no. 6, 41-48.
334. Forschungsinstitut Leningrad, DE 2820445, 1978.
335. U. Neitzel, *Kali Steinsalz* 9 (1986) 257-261.
336. G. Z. Zelmanov, V. G. Terlo, *Sov. Chem. Ind.* 18 (1986) no. 5, 46-48.
337. Graessor Contactors, GB 2270308, 1992.
338. Mannesmann, DE 4340839, 1993.
339. FIAT, Microfilm H-45, Frames 7834-7842 (PB. 70041).
340. BIOS Final Report no. 855.
341. Waagner-Biro, Chemiefaser Lenzing, AT 349494, 1976.
342. Rockwell International, EP-OS 91948, 1981.
343. J. H. Cameron et al., *Ind. Eng. Chem. Fundam.* 24 (1985) 443-449.
344. BIOS Final Report no. 288.
345. H. L. Murray: Office Publication Board, Report No. 223 (*Bibl. Sci. Ind. Rep.* 1 (1946) 7).
346. Metallgesellschaft AG, EP-OS 540072, 1991.
347. H. Rüter in F. Ebel (ed.): *Chemische Berichte*, Reichsamt für Wirtschaftsausbau, Berlin Dec. 1941, p. 201-208.
348. FIAT Final Report no. 989.
349. Metallgesellschaft AG, GB 473520, 1936; 513744, 1937.
350. BIOS Final Report no. 107.
351. *Ullmann*, 4th ed., 17, 555-556.
352. *Kirk-Othmer*, 3rd ed., 19, 395-406.
353. In [247], 3, 117.
354. Henkel, EP-OS 302403, 1988.
355. *Ullmann*, 4th ed., 22, 643, 660.
356. Allegheny Ludlum, US 4824536, 1988.

357. Zusatzstoff-Verkehrsordnung vom 10.07.1984, BGBl. I, no. 30 (1984), 897-901, and Anlage 2, p. 64.
358. S. N. Gaeta, *Chem. Sep. Dev. Sel. Pap. Int. Conf., Sep. Sci. Technol. 1st* 1986, no. 2, 95-106.
359. Walhalla-Kalk, EP 250626, 1986.
360. In [235], part 1, 226, 246-247; part 3, 1149-1159.
361. *Ullmann*, 4th ed., 9, 612-613.
362. Hoechst, DE-OS 2810693, 1978.
363. Mannesmann, DE-OS 3723292, 1987.

## 52 Potassium

JÖRG BRÜNING, ELIZABETH R. BURKHARDT (§§ 52.1–52.2, 52.5–52.10); HEINZ SCHULTZ (RETIRED) (§§ 52.3, 52.4 INTRODUCTION, 52.4.2.3, 52.4.3–52.4.5, 52.11 EXCEPT 52.11.3 AND 52.11.7, 52.12, 52.17, 52.18); GÜNTER BAUER (RETIRED), ERICH SCHACHL (RETIRED) (§§ 52.4.1–52.4.2.2); FRITZ HAGEDORN (§§ 52.11.3, 52.11.7); PETER SCHMITTINGER (§§ 52.13–52.15); TAKAO MAKI (§ 52.16)

|           |  |      |           |  |      |
|-----------|--|------|-----------|--|------|
| 52.1      | Introduction .....   | 2142 | 52.11.3.6 | Processes .....  | 2178 |
| 52.2      | Properties .....   | 2142 | 52.11.4   | Electrostatic Separation .....                                       | 2180 |
| 52.3      | History .....  | 2143 | 52.11.4.1 | Theoretical Basis .....  | 2180 |
| 52.4      | Occurrence .....   | 2144 | 52.11.4.2 | Equipment and Processes .....  | 2181 |
| 52.4.1    | Potash Salt Deposits .....                                   | 2145 | 52.11.5   | Heavy-Media Separation .....   | 2182 |
| 52.4.1.1  | Minerals .....   | 2145 | 52.11.6   | Debrining and Drying .....   | 2183 |
| 52.4.1.2  | Geology of Potash Deposits .....                             | 2146 | 52.11.7   | Process Measurement and Control .....                                | 2184 |
| 52.4.2    | Mining of Potash Salts .....                                 | 2147 | 52.11.8   | Waste Disposal and Environmental Aspects .....                       | 2185 |
| 52.4.2.1  | Shaft Mining .....   | 2147 | 52.11.9   | Granulation .....  | 2187 |
| 52.4.2.2  | Extraction, Conveying, and Haulage .....                     | 2147 | 52.11.10  | Quality Specifications .....   | 2188 |
| 52.4.2.3  | Solution Mining .....  | 2148 | 52.11.11  | Toxicology and Occupational Health .....                             | 2189 |
| 52.4.3    | Treatment of Potash Ores .....                               | 2149 | 52.11.12  | Economic Aspects and Uses .....                                      | 2189 |
| 52.4.3.1  | Intergrowth and Degree of Liberation .....                   | 2149 | 52.12     | Potassium Sulfate .....  | 2190 |
| 52.4.3.2  | Grinding .....   | 2151 | 52.12.1   | Properties .....   | 2190 |
| 52.4.4    | Potash–Magnesia .....  | 2152 | 52.12.2   | Raw Materials .....  | 2191 |
| 52.4.5    | Production of Potassium Salts from Other Raw Materials ..... | 2153 | 52.12.3   | Production .....   | 2191 |
| 52.4.5.1  | The Dead Sea .....   | 2153 | 52.12.3.1 | From KCl and H <sub>2</sub> SO <sub>4</sub> (Mannheim Process) ..... | 2191 |
| 52.4.5.2  | The Great Salt Lake .....                                    | 2153 | 52.12.3.2 | From KCl and MgSO <sub>4</sub> .....                                 | 2193 |
| 52.4.5.3  | Searles Lake .....   | 2154 | 52.12.3.3 | From KCl and Langbeinite .....                                       | 2194 |
| 52.4.5.4  | Other Sources .....  | 2154 | 52.12.3.4 | From KCl and Kainite .....   | 2195 |
| 52.5      | Production of the Metal .....                                | 2155 | 52.12.3.5 | From KCl and Na <sub>2</sub> SO <sub>4</sub> .....                   | 2195 |
| 52.6      | Analytical and Test Methods .....                            | 2155 | 52.12.3.6 | From KCl and CaSO <sub>4</sub> .....                                 | 2196 |
| 52.7      | Economic Aspects .....                                       | 2156 | 52.12.3.7 | From Alunite .....   | 2196 |
| 52.8      | Health and Safety Factors .....                              | 2156 | 52.12.3.8 | From Natural Brines and Bitterns .....                               | 2196 |
| 52.9      | Potassium–Sodium Alloys .....                                | 2157 | 52.12.4   | Granulation .....  | 2196 |
| 52.10     | Uses .....   | 2158 | 52.12.5   | Quality Specifications .....   | 2197 |
| 52.10.1   | Potassium Bases .....  | 2158 | 52.12.6   | Toxicology and Occupational Health .....                             | 2197 |
| 52.10.2   | Potassium Graphite (C <sub>8</sub> K) .....                  | 2158 | 52.12.7   | Economic Aspects and Uses .....                                      | 2197 |
| 52.10.3   | Potassium Hydride .....                                      | 2159 | 52.13     | Potassium Hydroxide .....  | 2198 |
| 52.10.4   | Potassium Superoxide .....                                   | 2159 | 52.13.1   | Properties .....   | 2198 |
| 52.11     | Potassium Chloride .....                                     | 2159 | 52.13.2   | Production .....   | 2198 |
| 52.11.1   | Properties .....   | 2160 | 52.13.3   | Quality Specifications .....   | 2199 |
| 52.11.2   | Production by Crystallization from Solution .....            | 2160 | 52.13.4   | Economic Aspects and Uses .....                                      | 2199 |
| 52.11.2.1 | Phase Theory .....   | 2160 | 52.14     | Potassium Carbonate .....  | 2199 |
| 52.11.2.2 | Hot Leaching Process .....                                   | 2162 | 52.14.1   | Properties .....   | 2199 |
| 52.11.2.3 | Processing of Carnallite .....                               | 2166 | 52.14.2   | Production .....   | 2200 |
| 52.11.2.4 | Equipment .....  | 2170 | 52.14.3   | Quality Specifications and Analysis .....                            | 2202 |
| 52.11.3   | Flotation .....  | 2174 | 52.14.4   | Storage and Transportation .....                                     | 2203 |
| 52.11.3.1 | Potash Ores Suitable for Flotation .....                     | 2174 | 52.14.5   | Economic Aspects and Uses .....                                      | 2203 |
| 52.11.3.2 | Carrier Solutions .....                                      | 2175 | 52.15     | Potassium Hydrogencarbonate .....                                    | 2204 |
| 52.11.3.3 | Flotation Agents .....                                       | 2175 | 52.15.1   | Properties and Production .....                                      | 2204 |
| 52.11.3.4 | Theory .....   | 2175 | 52.15.2   | Uses .....   | 2204 |
| 52.11.3.5 | Flotation Equipment .....                                    | 2177 | 52.16     | Potassium Benzoate .....   | 2204 |
|           |  |      | 52.17     | Storage and Transportation .....                                     | 2204 |

## 52.1 Introduction

Potassium is the third element in the alkali-metal series. The name is derived from the word *potash*. The German name *Kalium*, is derived from the Arabic word *qalia* and is the source for the element symbol K. The ashes of these plants (*al qalia*) were the historical source of potash for preparing fertilizers or gun powder.

Potassium ions are essential to plants and animals. They play a key role in carbohydrate metabolism in plants. In animals, potassium ions promote glycolysis, lipolysis, the breathing of tissue, the synthesis of proteins and acetylcholine. Potassium ions are also believed to function in regulating blood pressure.

Potassium and sodium share the position of the seventh most abundant element. Common minerals such as alums, feldspars and micas are rich in potassium. The largest potassium chloride deposit is in Saskatchewan, Canada while the largest deposit of the double salt,  $\text{KCl} \cdot \text{MgCl}_2 \cdot 6\text{H}_2\text{O}$  is in Solikamsk, Russia. Potassium metal, a powerful reducing agent, does not occur in nature.

## 52.2 Properties

**Physical Properties.** Potassium, a soft, low density, silver-colored metal, has high thermal and electrical conductivities, and a very low ionization energy. One very useful physical property of potassium is that it forms liquid alloys with other alkali metals such as Na, Rb, and Cs. These alloys have very low vapor pressures and melting points.

Potassium has three naturally occurring isotopes:  $^{39}\text{K}$  (93.22%),  $^{40}\text{K}$  (0.01%) and  $^{41}\text{K}$  (6.77%). The radioactive decay of  $^{40}\text{K}$  to Argon ( $^{40}\text{Ar}$ ), half-life of  $1.25 \times 10^9$  years, makes it a useful tool for geological dating.

Some physical properties of potassium are summarized below [1-3]:

|               |          |
|---------------|----------|
| Atomic weight | 39.102   |
| Atomic radius | 0.235 nm |

|                                 |   |
|---------------------------------|---|
| Ionic radius                    | 0.133 nm                                |
| Pauling electronegativity       | 0.8                                     |
| Crystal lattice                 | body-centered cubic                     |
| Analytical spectral line        | 766.4 nm                                |
| Melting point                   | 63.7 °C                                 |
| Boiling point                   | 760 °C                                  |
| Density at 20 °C                | 0.76 g·cm <sup>3</sup>                  |
| Specific heat                   | 0.741 J g <sup>-1</sup> K <sup>-1</sup> |
| Heat of fusion                  | 59.591 J/g                              |
| Heat of vaporization            | 2.075 kJ/g                              |
| Electrical conductance at 20 °C | 0.23 μs                                 |
| Surface tension at 100 °C       | 86 mN/m (dyn/cm)                        |
| Thermal conductivity at 200 °C  | 44.77 Wm <sup>-1</sup> K <sup>-1</sup>  |

**Chemical Properties.** Potassium has an electron-configuration of  $1s^2 2s^2 2p^6 3s^2 3p^6 4s^1$ . All alkali-metals (Li, Na, K, Rb, Cs) are good reducing agents. They have a strong tendency to attain inert-gas electron configuration by giving away the single, unpaired valence electron. Reducing power increases from lithium to cesium. The alkali metals share many common features, yet they differ in size, atomic number, ionization potential, and solvation energy. As a result, each maintains its own individual chemical characteristics.

Cesium and rubidium are too reactive for safe handling and are not commercially available in large quantities. Potassium is the most electropositive reducing agent used in industry. Among K, Na and Li compounds, potassium compounds are more ionic and more nucleophilic. Potassium ions form loose or solvent-separated ion-pairs with their counteranions in polar solvents. Large potassium cations tend to stabilize delocalized (soft) anions in transition-states. In contrast, lithium compounds are more covalent, more soluble in non-polar solvents, and usually existing as aggregates (tetramers and hexamers) in the form of tight ion pairs. Small lithium cations stabilize localized (hard) counteranions. Sodium chemistry is intermediate between that of potassium and lithium.

The superb reducing power of potassium metal is clearly demonstrated by its facile displacement of protons in the weakly acidic hydrocarbons, amines, and alcohols (Table 52.1) and reactions with inorganics and gaseous ele-

ments (Table 52.2). In addition, oxides, hydroxides and salts of numerous metals are reduced by potassium to the metallic state.

**Table 52.1:** Potassium products from hydrocarbons, amines and alcohols.

| Starting material    | pK <sub>a</sub> <sup>1</sup> | Product   |
|----------------------|------------------------------|---|
| 1,3-Diaminopropane   | 35                           | KNH(CH <sub>2</sub> ) <sub>3</sub> NH <sub>2</sub>  |
| Ammonia              | 35                           | KNH <sub>2</sub>                                    |
| Hexamethyldisilazane | 28                           | KN[Si(CH <sub>3</sub> ) <sub>3</sub> ] <sub>2</sub> |
| Aniline              | 27                           | KNHC <sub>6</sub> H <sub>5</sub>                    |
| Acetylene            | 25                           | KC≡CH   |
| <i>tert</i> -Butanol | 18                           | KOC(CH <sub>3</sub> ) <sub>3</sub>                  |
| Methanol             | 16                           | KOCH <sub>3</sub>                                   |
| Phenol               | 10                           | KOC <sub>6</sub> H <sub>5</sub>                     |

<sup>1</sup>pK<sub>a</sub> refers to the pK<sub>a</sub> of the conjugate acid of the potassium base.

**Table 52.2:** Typical chemical reactions of potassium.

| Reactant   | Reaction   | Product   |
|--|--|---|
| H <sub>2</sub>                                     | begins slowly at 200 °C, rapid above 300 °C                                      | KH  |
| O <sub>2</sub>                                     | begins slowly with solid, fairly rapid with liquid                               | K <sub>2</sub> O, K <sub>2</sub> O <sub>2</sub> , KO <sub>2</sub>               |
| H <sub>2</sub> O                                   | extremely vigorous and frequently results in hydrogen-air explosions             | KOH, H <sub>2</sub>   |
| C (graphite)                                       | 150-400 °C   | KC <sub>4</sub> , KC <sub>8</sub> , KC <sub>24</sub> (KCO)                      |
| CO   | forms unstable carbonyls   |   |
| NH <sub>3</sub>                                    | dissolves as K; iron, nickel, and other nmetals catalyze in gas and liquid phase | KNH <sub>2</sub>  |
| S  | molten state in liquid ammonia   | K <sub>2</sub> S, K <sub>2</sub> S <sub>2</sub> , K <sub>2</sub> S <sub>4</sub> |
| F <sub>2</sub> , Cl <sub>2</sub> , Br <sub>2</sub> | violent to explosive   | KF, KCl, KBr  |
| I <sub>2</sub>                                     | ignition   | KI  |
| CO <sub>2</sub>                                    | readily, but sometimes explosive   | CO, C, K <sub>2</sub> CO <sub>3</sub>   |

## 52.3 History

Before the discovery and exploitation of potassium salt deposits, the production of potassium compounds consisted almost entirely of potash (K<sub>2</sub>CO<sub>3</sub>) obtained from natural sources such as wood ash, residues from distilleries, Bengal saltpeter, wool grease, and mother liquors from sea salt production. Quantities were small and were used only for the production of soap, glass, and explosives.

In 1840, J. VON LIEBIG laid the foundations of the theory of mineral fertilizers in his paper "The Application of Organic Chemistry to

Agriculture and Physiology". This spread the knowledge that potassium was one of the most important plant nutrition elements. In 1851, some deep mine workings in Stassfurt struck minerals containing potassium and magnesium, although these could not be used as fertilizers. In 1861, ADOLPH FRANK started the first plant using the process that he developed for producing from carnallite a potassium salt that could be employed as a fertilizer. This soon led to the development of other processes and to the establishment of many potash mines and works. Many attempts were made up to the end of World War I to hinder the building of new factories in Germany, which had a world monopoly in the production of potash fertilizers, and attempts were made to ration production and supply, and to regulate prices. In spite of this, 69 factories were in existence in 1910, and 198 in 1918. When World War I ended, Alsace was returned to France, and the potash works that were built there shortly after 1900 became French property, so that Germany lost her monopoly in potash.

The German national assembly of 1919 enacted the potash regulations and the so-called closure order, which reduced the number of operating factories to 29 by the year 1938. This also caused production to be concentrated in a few large potash companies [95, 96].

After the end of World War II, ca. 60% of German production capacity went to the area that was later to become the German Democratic Republic, and became the VEB Kombinat Kali. After German unification in 1990, the newly formed Mitteldeutsche Kali AG took over these operations. In West Germany, several groups of works were formed, leading in 1970 to the formation of the company Kali und Salz AG following a series of amalgamations. This company owns seven potash works, all located in the former Federal Republic of Germany [97, 98].

Most of the French potash works in Alsace were nationalized after World War I. During World War II, production was greatly increased. Several of the deposits have now become exhausted, and many of the works have

been closed. Production has been concentrated in two large works, although these are likely to be closed down soon after the end of this century [99].

Potash production in Spain began in 1926 with the start up of a factory in Catalonia. Other factories were established later both there and in Navarra.

The kainite deposits in Sicily have been worked since 1959–1960; the salts are used for potassium sulfate production [100].

The Soviet Union began potash production in 1931 at a plant in the Northern Urals. In 1939, plants that had been operating in Eastern Poland since 1920 were taken over by the Soviet Union. In 1963, the first plant was started to exploit a very extensive deposit in White Russia. The CIS today has several large operations in the Urals and White Russia, giving it the largest capacity of all potash-producing countries.

In the United States, potash production began during World War I because the United States economy could no longer buy German potash fertilizers. Potassium salts were obtained from Searles Lake in California and in northern Nebraska. Most of these operations ceased production in the 1920s. After the discovery of potash deposits in the area of Carlsbad, New Mexico, a large number of potash works were founded since 1931 [101]. Since the foundation of the Canadian potash industry, which has the United States as its main outlet, the number of works in the Carlsbad region and their production rate have continually declined. New potash works were started in southern Utah at Moab in 1964 and at the Great Salt Lake in 1970 [102].

The most important potash deposit in North America was discovered during World War II in Saskatchewan, Canada. After initial problems due to its great depth and the presence of water-bearing overlying rock, which was difficult to deal with, several potash works were founded in the early 1960s, and today Canada is second only to the CIS as a potash producer. Two more potash plants were established in the 1980s in New Brunswick on the east coast of Canada.

In 1986, a potash plant began production at Sergipe in Brazil.

In 1974, a potash mine was opened in Yorkshire, United Kingdom.

Potash production in Palestine began on the north bank of the Dead Sea in 1931. Potash plants have now been producing since 1952 at the southern end on the Israeli side and since 1982 on the Jordanian side.

Potash ores are treated today by three basic processes: leaching–crystallization, flotation, and electrostatic treatment. Gravity separation is of minor importance because of the small density differences between salt minerals.

The oldest process is leaching–crystallization. In this process, salt solutions were originally cooled in open vessels. Vacuum cooling of the solutions in crystallizers was introduced in 1918 in the United States, so that much less energy was required and cooling times were reduced from days or weeks to minutes. Flotation was introduced in 1935 in the United States. This proved so efficient, especially for the treatment of sylvinitic ores, that it is now the main potash treatment process worldwide. The electrostatic process was first used on a large scale in the German potash industry in 1974. It is now widely used in Germany for treating complex hard salts.

## 52.4 Occurrence

Potassium occurs in nature only in the form of its compounds. It is one of the ten most common elements in the earth's crust. Several widely distributed silicate minerals contain potassium, in particular, the feldspars and micas. The weathering of these minerals produces soluble potassium compounds, which are present in seawater and occur in extensive salt deposits. Potassium is important in the metabolism of plants and animals, and is therefore found in ash from plant materials and in the bodies of animals. Potassium compounds are obtained almost entirely by the mining of salt deposits.

## 52.4.1 Potash Salt Deposits

### 52.4.1.1 Minerals

Potash salt deposits were formed by the evaporation of seawater [103]. Their composition is often affected by secondary changes in the primary mineral deposits. More than 40 salt minerals are now known, which contain some or all of the small number of cations  $\text{Na}^+$ ,  $\text{K}^+$ ,  $\text{Mg}^{2+}$ , and  $\text{Ca}^{2+}$ ; the anions  $\text{Cl}^-$  and  $\text{SO}_4^{2-}$ ; and occasionally  $\text{Fe}^{2+}$  and  $\text{BO}_3^{3-}$ , as well. Most of these are listed in Table 52.3 [104].

The more important salt minerals are halite, anhydrite, sylvite, carnallite, kieserite, polyhalite, langbeinite, and kainite. Gypsum occurs at the edges of salt deposits and in the overlying strata. Bischofite, tachhydrite,

glauberite, thenardite, glaserite, and leonite occur additionally in some deposits [82, 105, 106].

Other minerals, not described in detail here, are useful in elucidating difficult geological questions with regard to the origin of salt deposits. In special geochemical investigations, small amounts (ppm) of  $\text{Rb}^+$  and  $\text{Cs}^+$  in place of  $\text{K}^+$ ;  $\text{Sr}^{2+}$  replacing  $\text{Ca}^{2+}$ ;  $\text{Mn}^{2+}$  replacing  $\text{Fe}^{2+}$ ;  $\text{Br}^-$  replacing  $\text{Cl}^-$ ; etc., are important [107, 108]. The individual minerals can be identified microscopically (grains or thin sections) and by X-ray analysis.

Potassium salt deposits always consist of a combination of several minerals (Table 52.4). The German term *Hartsalz* (hard salt) refers to the greater hardness of sulfate-containing potash minerals in potash deposits.

Table 52.3: Principal salt minerals.

| Mineral   | Formula  | Crystal system/<br>crystal class | Refractive indices $n_\alpha:n_\beta:n_\gamma$<br>or $n_{\text{opt}}:n_c$<br>optical activity | Density,<br>g/cm <sup>3</sup> | Hardness<br>(Mohs) |
|---|--|----------------------------------|---|-------------------------------|--------------------|
| Anhydrite                                       | $\text{CaSO}_4$  | rhombic, $D_{2h}$ -mmm           | 1.570:1.575:1.614, opt. +   | 2.96                          | 3.8                |
| Ascharite                                       | $\text{Mg}_2[\text{B}_2\text{O}_5] \cdot \text{H}_2\text{O}$                         | monoclinic, $C_{2h}$ -2/m        | 1.575:1.646:1.650, opt. –   | 2.70                          | 3                  |
| Astrakhanite                                    | $\text{Na}_2\text{Mg}[\text{SO}_4]_2 \cdot 4\text{H}_2\text{O}$                      | monoclinic, $C_{2h}$ -2/m        | 1.483:1.486:1.487, opt. –   | 2.23                          | 3                  |
| Bischofite                                      | $\text{MgCl}_2 \cdot 6\text{H}_2\text{O}$  | monoclinic, $C_{2h}$ -2/m        | 1.495:1.507:1.528, opt. +   | 1.60                          | 1.5                |
| Boracite (stassfurtite: lumpy form of boracite) | $\text{Mg}_3[\text{Cl}/\text{B}, \text{O}]_{13}$                                     | rhombic, $C_{2v}$ -mm2           | 1.662:1.667:1.673, opt. +   | 2.95                          | 7                  |
| Carnallite                                      | $\text{KMgCl}_3 \cdot 6\text{H}_2\text{O}$   | rhombic, $D_{2h}$ -mmm           | 1.467:1.475:1.495, opt. +   | 1.60                          | 2.7                |
| D'Ansire  | $\text{Na}_2\text{Mg}[\text{Cl}_3(\text{SO}_4)_{10}]$                                | cubic, Td-43m                    | 1.489   | 2.65                          |                    |
| Epsomite  | $\text{MgSO}_4 \cdot 7\text{H}_2\text{O}$  | rhombic, $D_2$ -222              | 1.432:1.455:1.461, opt. –   | 1.68                          | 2.5                |
| Glaserite                                       | $\text{K}_3\text{Na}[\text{SO}_4]_2$   | trigonal, $D_{3d}$ -3m           | 1.491:1.498, opt. +   |                               |                    |
| Glauberite                                      | $\text{CaNa}_2[\text{SO}_4]_2$   | monoclinic, $C_{2h}$ -2/m        | 1.515:1.532:1.536, opt. –   | 2.85                          | 3                  |
| Gypsum  | $\text{CaSO}_4 \cdot 2\text{H}_2\text{O}$  | monoclinic, $C_{2h}$ -2/m        | 1.521:1.523:1.530, opt. +   | 2.32                          | 2                  |
| Halite (rock salt)                              | $\text{NaCl}$  | cubic, $O_h$ -m3m                | 1.5443  | 2.168                         | 2.5                |
| Kainite   | $(\text{KMg}[\text{ClSO}_4])_4 \cdot 11\text{H}_2\text{O}$                           | monoclinic, $C_{2h}$ -2/m        | 1.494:1.506:1.516, opt. –   | 2.13                          | 3                  |
| Kieserite                                       | $\text{MgSO}_4 \cdot \text{H}_2\text{O}$   | monoclinic, $C_{2h}$ -2/m        | 1.518:1.531:1.583, opt. +   | 2.57                          | 3.7                |
| Koenerite                                       | $[\text{Mg}_7\text{Al}_4(\text{OH})_{22}][\text{Na}_4(\text{CaMg})_2\text{Cl}_{12}]$ | trigonal, $D_{3d}$ -3m           | 1.55:1.58, opt. +   | 2.15                          | 1                  |
| Langbeinite                                     | $\text{K}_2\text{Mg}_2[\text{SO}_4]_3$   | cubic, T-23                      | 1.534   | 2.83                          | 4.2                |
| Leonite   | $\text{K}_2\text{Mg}[\text{SO}_4]_2 \cdot 4\text{H}_2\text{O}$                       | monoclinic, $C_{2h}$ -2/m        | 1.479:1.483:1.488, opt. +   | 2.20                          | 2.7                |
| Löweite   | $\text{Na}_{12}\text{Mg}_7[\text{SO}_4]_{13} \cdot 15\text{H}_2\text{O}$             | trigonal, $C_{3i}$ -3            | 1.495:1.478, opt. –   | 2.34                          | 2.5–3              |
| Mirabilite (Glauber's salt)                     | $\text{Na}_2\text{SO}_4 \cdot 10\text{H}_2\text{O}$                                  | monoclinic, $C_{2h}$ -2/m        | 1.394:1.396:1.398, opt. –   | 1.49                          | 1.7                |
| Polyhalite                                      | $\text{K}_2\text{MgCa}_2[\text{SO}_4]_4 \cdot 2\text{H}_2\text{O}$                   | triclinic, $C_1$ -1              | 1.548:1.562:1.567, opt. –   | 2.78                          | 3–3.6              |
| Rinneite  | $\text{K}_2\text{Na}[\text{FeCl}_4]$   | trigonal, $D_{3d}$ -3m           | 1.588:1.589, opt. +   | 2.35                          | 3                  |
| Schönite  | $\text{K}_2\text{Mg}[\text{SO}_4]_2 \cdot 6\text{H}_2\text{O}$                       | monoclinic, $C_{2h}$ -2/m        | 1.461:1.463:1.476, opt. +   | 2.03                          | 2.6                |
| Sylvite   | $\text{KCl}$   | cubic, $O_h$ -m3m                | 1.4903  | 1.99                          | 2                  |
| Syngenite                                       | $\text{K}_2\text{Ca}[\text{SO}_4]_2 \cdot \text{H}_2\text{O}$                        | monoclinic, $C_{2h}$ -2/m        | 1.501:1.517:1.518, opt. –   | 2.58                          | 2.5                |
| Tachhydrite                                     | $\text{CaMg}_2\text{Cl}_6 \cdot 12\text{H}_2\text{O}$                                | trigonal, $D_{3d}$ -3m           | 1.520:1.512, opt. –   | 1.67                          | 2                  |
| Thenardite                                      | $\text{Na}_2\text{SO}_4$   | rhombic, $D_{2h}$ -mmm           | 1.471:1.477:1.484, opt. +   | 2.67                          | 2.7                |
| Vanthoffite                                     | $\text{Na}_6\text{Mg}[\text{SO}_4]_4$  | monoclinic, $C_{2h}$ -2/m        | 1.485:1.4876:1.489, opt. –  | 2.69                          | 3.6                |

**Table 52.4:** Marine salt rocks: mineral constituents (A = anhydrite; Bi = bischofite; C = carnallite; Dol = dolomite; Kai = kainite; Ki = kieserite; La = langbeinite; Mag = magnesite; Na = halite; Po = polyhalite; Sy = sylvite; Ta = tachhydrite).

| Salt rock     | Main components                          | Secondary components                                |
|---------------|--|---|
| Rock salt     | Na                                       | A, Po, Ki, La, clay minerals, etc.                  |
| Anhydrite     | A  | Na, Dol, Mag, gypsum, Sy, C, clay minerals, borates |
| Carnallite    | C, Na                                    | Ki, Sy, A   |
| Sylvinite     | Sy, Na                                   | C, Ki, A  |
| Hard salt     |  |   |
| Kieseritic    | Na, Ki, Sy                               | C, A, La, Po, borates                               |
| Langbeinitic  | Na, La                                   | Ki, A, Sy, C  |
| Anhydritic    | Na, Sy, A                                | Ki, C   |
| Kainitic      | Na, Kai                                  | Ki, Sy, C   |
| Bischofite    | Bi, C and/or Ta                          | Na, Ki, Po, A, borates                              |
| Tachhydritite | Ta, Bi                                   | C, Na   |
| Claystone     | Clay minerals, quartz, mica, A, Dol, Mag | Na, Sy, C, Bi, Ta, La, coenenite, rinneite          |

### 52.4.1.2 Geology of Potash Deposits

Potash deposits occur worldwide in almost all geological systems. The most important deposits were formed in the Devonian, Carboniferous, Permian, Cretaceous, and Tertiary periods [82, 103, 105, 109–115]. All major potash deposits are of marine origin. Bodies of seawater became isolated from the open ocean when bars formed under the water surface, and under arid climatic conditions the seawater became concentrated, finally depositing the dissolved salts. The important feature is that exchange between normal seawater and concentrated salt solution generally does not occur. During sedimentation, the less soluble salts were deposited first, and the most soluble salts last. In most salt-forming sea basins, this process was repeated many times, resulting in cyclical salt formation [114, 116].

A complete salt deposition cycle begins with basic carbonates (limestone, dolomite, and sometimes magnesite), followed by sulfates (gypsum and anhydrite), rock salt, and finally potassium and magnesium salts (Table 52.3). Intermediate layers of clay sediments are the result of repeated influxes of fresh water, which can lead to partial redissolution of

the salt deposits. Also, eolian (airborne) transportation into the basin can occur. A recent example of a salt deposition basin is provided by the Kara-Bugas, a lagoon on the eastern side of the Caspian Sea.

In the course of the earth's history, the deposited salts underwent many changes, often leading to the formation of a modified mineral constitution. The original formations were affected by relatively low-temperature thermal and hydraulic metamorphoses, and sometimes by volcanic action, producing the mineral compositions that exist today (Table 52.4) [117, 118].

Rock movements have changed the original horizontal stratification in many salt deposits. Salt migration, folding, and upward movement to form diapirs have led to tilting of the potash layer, sometimes to an acute angle; to thinning; or to local accumulation. As a result of movements, salt deposits often came into contact with groundwater and were partially or completely redissolved.

Table 52.5 shows the distribution of potash deposits, with estimates of the reserves [82, 115, 119].

The concept of a reserve presupposes the possibility of economical extraction, which depends on the presence of a useful potash content together with usable quantities of other materials. Other important factors are the type of deposit, a uniform and usable seam thickness at a depth that is neither too great nor too low (water problems), economic workability, the possibility of solution extraction, and above all, proximity to consumers and profitability. Losses incurred during the extraction process (10–20%) must be deducted from the total size of the reserve.

The two largest known potash deposits in the world, which are in Saskatchewan (Canada) and White Russia, are of Devonian origin. The Permian deposits (Germany, United States, and CIS) were for a long period the classical salt deposits and were the most important potash reserves, but these lost their economic importance after World War II.

**Table 52.5:** Mineable potash reserves in units of  $10^6$  t  $K_2O$ .

|   |             |
|---|-------------|
| Canada, Saskatchewan (conventional mining only) | 4500–6000   |
| New Brunswick                                   | 60–80       |
| United States                                   | 100–150     |
| Brazil  | 10–40       |
| Chile and Peru                                  | 30–50       |
| Congo   | ca. 20      |
| Germany   | 400–800     |
| United Kingdom                                  | 30–50       |
| Italy   | 10–20       |
| France  | ca. 20      |
| Spain   | 20–30       |
| Commonwealth of Independent States              | 2000–3000   |
| Dead Sea (Israel and Jordan)                    | 100–200     |
| China   | 10–100      |
| Thailand  | up to 160   |
| Laos  | up to 20    |
| World <sup>a</sup>                              | 7500–10 000 |

<sup>a</sup>If reserves only extractable by solution mining are included (particularly those in Saskatchewan, but also including those in the CIS), the figure for the total minable reserves increases by a factor of 4 or 5. Other deposits of potash salts are either unimportant or of minor local importance compared with the above figures. These exist in Australia, Ethiopia, Iran, Libya, Morocco, Poland, and Tunisia.

However, the known potential of extractable potash deposits is so large that the world supply is guaranteed for many hundreds of years.

**Salt Lakes and Subterranean Brines.** *Israel and Jordan.* Potassium chloride, magnesium chloride, rock salt, soda, chlorine, and bromine are obtained from the Dead Sea [82, 115].

*United States.* Potassium and sodium sulfate are extracted from the Great Salt Lake [82, 115]. Potassium and magnesium chloride are obtained from subterranean brines from the Great Salt Lake Desert [82]. Potassium chloride and sulfate, sodium borate, and boric acid are obtained from subterranean brines in Searles Lake [82, 115].

*Australia.* Langbeinite is obtained from subterranean brines at Lake McLeod.

*China.* Tsaerhan Lake, a dry lake, ca. 1100 km northeast of Lhasa, the largest salt lake in the Chaidamu basin, appears to be the most important potential reserve of potassium chloride in China [82, 115].

## 52.4.2 Mining of Potash Salts

### 52.4.2.1 Shaft Mining

Mineral salts are very soluble, and therefore any flow of water into the mine from the overlying strata, which are normally water bearing, must be prevented. This causes difficulties when sinking a shaft, and severe accidents have been caused by influxes of water. The freezing technique, especially deep freezing, is comparatively safe and is currently used to sink most mineshafts. The shaft itself is protected from water-bearing rocks by the use of tubbings, which are segments bolted together to form rings and are usually made from cast iron or steel-reinforced concrete. The shafts generally have a diameter of 5–7 m, and the depth can exceed 1000 m.

### 52.4.2.2 Extraction, Conveying, and Haulage

In most potash mines, the salt is mined from subhorizontal deposits. Generally, rooms are created by removing the salt, and pillars are left between these to prevent the cover rocks from collapsing. This enables an extraction rate of 25–60% to be achieved. For cost reasons the mined-out rooms are not backfilled. In some mines, the total ore is extracted, which causes substantial subsidence of the overlying strata (Alsace).

In steeply dipping deposits (e.g., in the salt domes of northern Germany), roof mining was originally carried out. This was later replaced by floor mining and then by funnel mining, which is now being used increasingly in numerous variations [121]. Entry drifts are driven one above the other at intervals of 15–20 m, and the remaining potash salt is mined by sublevel stopping. Material loosened by explosives falls via the lowest funnel-shaped region into the main haulage level underneath. The mined-out room, 100–250 m in height, is usually backfilled with salt waste after mining. Funnel mining is much safer and cheaper than roof mining, because both ore stopping and backfilling take place under gravity, and

the mined room need not be reentered. During drilling of the blast holes, the miners are protected by horizontal pillars between the sub-levels.

Drilling and blasting operations are carried out with the help of trackless vehicles. Large holes with a diameter of ca. 40 cm and a length of 7 m are drilled by mobile drilling equipment, and another mobile drilling rig is used to drill blast holes around the larger hole in a pre-determined pattern. The explosive (generally ammonium nitrate with addition of oil) is brought to the workplace in tanks carried by diesel vehicles and is blown into the shot holes by compressed air.

In predominantly horizontal sylvinitic deposits, the most frequent method of extraction is by cutting with heavy machinery (180 t per unit) at high cutting rates. These machines produce material suitable for transport by conveyor belt, enabling continuous extraction in 30–60-m sections.

Extraction by borers with two to four rotors is mainly used to produce long pillars in a room and pillar system (Canada), the length of the chambers being as much as 1000 m. In longwall mining, however, which is usually carried out as a caving operation, two or three drum shearers are used (e.g., in Alsace and the CIS). These machines enable daily outputs between 1500 and 4000 t to be achieved.

The recovered material is transported by trackless diesel or cable-fed electric front-end loaders with a capacity of 15 t. Transport along underground roads is increasingly by conveyor belts but also by electric or diesel trains with 30-t-capacity wagons or by dumper trucks with a hopper capacity of 40 t. For transportation by conveyor belt, the material must first be broken into suitably sized pieces.

The network of roadways for conveying, traveling, and ventilation usually extends > 100 km in large potash works. A radio communication system is generally used.

Since the introduction of very heavy machinery and diesel-powered vehicles, extra attention must be given to ventilation. Powerful fans supply fresh air at up to 30 000 m<sup>3</sup>/min.

In hoisting shafts, the skips have a capacity of up to 25 t. These operate automatically and supply large intermediate storage bins in the filling station, so that the continuously operating manufacturing plants can be supplied with ore at a steady rate. Average daily throughput can be ca. 30 000 t of ore.

Improvements in mining methods and the introduction of new techniques have enabled the output per worker underground to be increased considerably. In Germany during 1965–1974 the output of potash ore increased by 20%, despite a > 50% reduction in the number of employees.

### 52.4.2.3 Solution Mining

Solution mining is an alternative to conventional mining for the extraction of potash ore. The advantages of this method are that the high expense of sinking a shaft is eliminated and reserves can be exploited where conventional mining is impossible (e.g., at great depth). Also, this method can be used where existing mine workings are available but conventional mining methods are no longer feasible, even though extensive reserves may still exist.

Since 1964, Kalium Chemicals in Saskatchewan has operated a plant in which brine extracted from a potash deposit at a depth of ca. 1500 m is used to produce very pure potassium chloride. The process is based on a series of patents [122], but details have not yet been published. Water or an unsaturated solution of potassium chloride is passed through a system of boreholes into the potash seam, which is 20–25 m thick; potassium chloride and sodium chloride are dissolved. The almost saturated solution is pumped to the surface and fed to the production plant. Rock salt above the potash seam is protected from dissolution by an oil or air cushion (see Figure 52.1). The brine produced passes through multiple-effect evaporators in which sodium chloride crystallizes. Potassium chloride is then crystallized in a series of vacuum coolers [123].

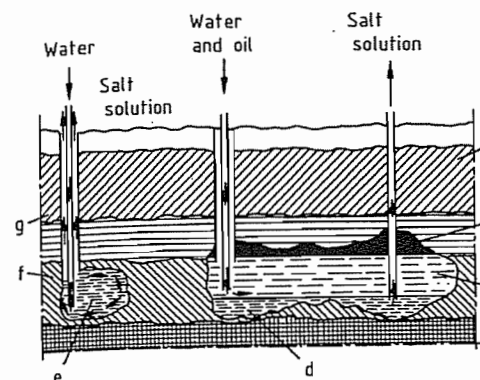

Figure 52.1: Solution mining: a) Overlying rock; b) Oil cushion; c) Partly unsaturated salt solution; d) Saturated salt solution; e) Cavity produced by dissolution; f) Potash deposit; g) Sodium chloride layer.

In Utah (United States), where it was necessary to terminate a conventional mining operation due to severe geological and technological problems, operation was resumed in 1972 by using solution mining. Shafts and underground cavities were flooded, providing a route for the brine formed when water was fed in to dissolve the salt. The brine was passed into surface ponds where solar evaporation caused a mixture of potassium chloride and sodium chloride to crystallize, which was treated in a flotation plant to produce 60% K<sub>2</sub>O potassium chloride [124].

In Canada a conventional mining operation was also converted to the solution mining method after penetration of water led to complete flooding of the mine and forced operations to cease. Water is passed via boreholes into the flooded mine and is converted into a concentrated brine, which is withdrawn and cooled in a pond during the very cold Canadian winter. The potassium chloride that crystallizes is recovered and processed to give a salable product [125].

In the former German Democratic Republic, extensive research into the solution mining of carnallite or potassium chloride from carnallitic deposits has been carried out. An experimental plant with a KCl capacity of ca. 50 000 t/a was operated for a long period [126].

## 52.4.3 Treatment of Potash Ores

### 52.4.3.1 Intergrowth and Degree of Liberation [127, 128]

The salt minerals in potash ores are intergrown to varying extents. Before the minerals can be separated and the useful components recovered, the ore must be sufficiently reduced in size so that individual components are accessible to the processing method to be used. In the hot leaching process, sylvite is extracted, and therefore it must first be liberated (i.e., it must not be occluded inside other minerals). To achieve this, it is sufficient to break down the ore to a particle size of 4–5 mm or less.

For the mechanical treatment processes (i.e., flotation, electrostatic treatment, and gravity separation), liberation of the minerals must be complete (i.e., individual grains must consist as much as possible of pure minerals). The extent to which the minerals in the potash ore are intergrown can vary greatly from deposit to deposit (see Figure 52.2), which means that the crude salt must be size-reduced to varying degrees before further processing.

The degree of intergrowth of individual minerals can be determined by examination of a thin section. A photomicrograph shows the sizes and shapes of individual minerals in relation to each other [129]. The disadvantage of this method is that a thin section gives only a two-dimensional view of a relatively small region of the salt mineral, and a very small sample of the substance is examined. The three-dimensional arrangement of minerals present and their distribution are not observed. For these reasons, and also because of the high cost of preparing thin sections, this method is now of only minor importance for the industrial processing of potash ores.

More usually, the degree of liberation in size-reduced samples is determined. The degree of liberation of a mineral means the percentage ratio of fully liberated mineral particles to the total content of the mineral in the sample.



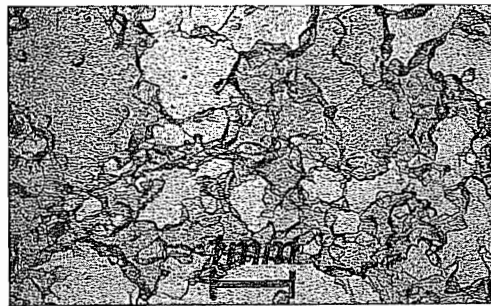
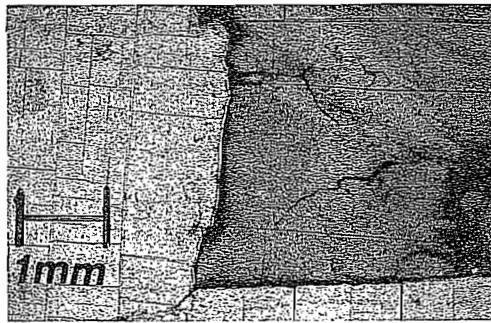

Figure 52.2: Thin sections of sylvinitic ores. A) Coarsely intergrown (potash works in Lanigan, Canada); B) Finely intergrown (Kaliwerk Sigmundshall, Germany).

Degree of liberation:

$$\frac{\% \text{ Free mineral}}{\% \text{ Free} + \% \text{ Intergrown mineral}} \times 100 \%$$

The degree of liberation  $L$  depends not only on the grain size achieved by the grinding operation but also on the type of grinding. It can be given for particular ranges of grain size so that the way in which it depends on grain size can be determined, or it can be expressed as an average for the total sample (the integral degree of liberation  $\bar{L}$ ). The arithmetic mean of the degree of liberation of each range of grain sizes is obtained from the following formula:

$$\bar{L} = \frac{\sum_{i=1}^n L_i p_i a_i}{100 a}$$

where  $p_i$  is the mass fraction of the  $i$ th size range in percent;  $a_i$  the percentage of useful mineral in the  $i$ th size range; and  $a$  the percentage of useful mineral in the total sample. Apart from the fraction of useful mineral  $a$ , which is determined by chemical analysis, the

liberated, nonintergrown fraction of useful mineral in each grain size range must be determined. Two methods for doing this are possible:

- Visual estimation (by counting under the microscope) of the proportion of intergrown particles
- Heavy-medium separation of the free or almost free grains

The first method is easy to apply to salt minerals because the intergrowth effects are readily recognized owing to the transparency of the grains. For coarse-grained materials such as those usually found in ground products from coarsely intergrown potash ores, this process cannot be used.

The separation of free or nearly free mineral grains from a size fraction is carried out by using heavy liquids of appropriate density, such as tetrabromoethane-toluene mixtures. A float-sink separation is carried out to determine the fraction of free mineral grains. This method cannot be used for salt particles with a grain size  $< 0.5$  mm because of the agglomeration of fine grains. In this case, the method of counting under the microscope must be used, or the degrees of liberation of the coarser size ranges must be extrapolated.

The results are expressed in liberation curves, which give the degree of liberation as a function of grain size (Figure 52.3).

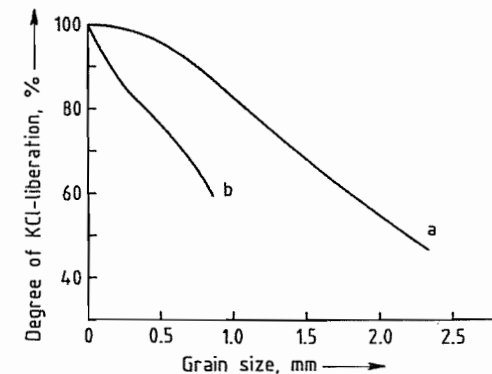

Figure 52.3: Liberation curves of sylvinitic ores: a) Coarsely intergrown sylvinitic ore (from New Brunswick, Canada); b) Finely intergrown sylvinitic ore (from a north German salt deposit).

### 52.4.3.2 Grinding [130, 131]

Potash salts are easily size-reduced. Therefore, fines may be formed, which can cause problems in later stages of processing. Great care must be taken in selection of the equipment for various stages of grinding.

The maximum grain size to which the potash ore is ground depends on the processing method used and the degree of intergrowth of the ore. For the hot leaching process, an upper grain size limit of 4–5 mm is adequate. For mechanical processing, the ore must be ground to a degree of liberation  $> 75\%$ . For German sylvinitic ores and hard salts, this is achieved by grinding to a maximum grain size of 0.8–1.0 mm. For the much coarser sylvinitic ores of New Mexico, a maximum grain size limit of 2.4 mm is sufficient. The sylvinitic ores of Saskatchewan are even more coarsely intergrown, so that size reduction to  $< 9$  mm would give adequate liberation. However, such large crystals cannot be treated by conventional flotation, and the material is therefore normally ground to  $< 2.3$  mm. One large Canadian manufacturer produces a coarse crystalline product by grinding the potash ore to  $< 9$  mm, removing grains  $< 1.7$  mm, and treating this fine material by conventional flotation. The remaining fraction (1.7–9 mm) is treated in a heavy-medium separation plant (see Section 52.11.5), giving a product with 60%  $K_2O$  (95% KCl) and a size distribution of the granular commercial grade.

The preliminary size reduction of potash ore is carried out by underground mobile crushers, usually in the vicinity of a mining operation. When the ore is mined by continuous mining this gives sufficient size reduction for it to go directly to the haulage line. Further size reduction to the grain size required for processing is carried out in two stages on the surface. An initial size reduction with impact or hammer mills is always carried out to produce 4–12-mm particles, depending on the raw material and processing method to be used. A coarse grinding plant usually includes two grinding and screening stages (Figure 52.4).

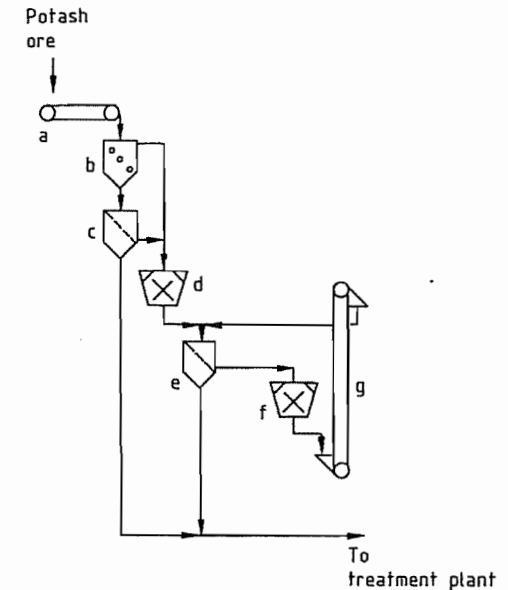

Figure 52.4: Two-stage grinding system: a) Conveyor belt; b) Grid; c) First screening stage; d) First grinding stage; e) Second screening stage; f) Second grinding stage; g) Bucket elevator.

The final fine grinding stage is carried out either by wet grinding in rod mills or by dry grinding with rollers or impact crushers (Figures 52.5 and 52.6). Wet grinding with rod mills in a recirculating system with classification is standard for most flotation plants. Classification is by spiral classifiers, vibrating screens, curved screens, or cyclones. Wet screening produces only a small amount of fines and has the further advantage of providing a scrubbing effect that facilitates the removal of clay from clay-bearing ores, a necessary step before the flotation process.

The production of a fine product by dry grinding is rarely used in flotation plants. It is indispensable as a preparation for electrostatic processing, which is not compatible either with the changes to the mineral surfaces caused by aqueous solutions or with excess moisture. The grinding operation must be carried out carefully to give a product low in fines. Roller mills and impact mills can be used. Roller mills have the disadvantage that throughputs are relatively low and maintenance costs are high. Although this was the

preferred method in the early days of electrostatic processing owing to its gentle grinding action, it has now been largely replaced by impact grinding, which is also used for size reduction of the middle product from electrostatic separation [132].

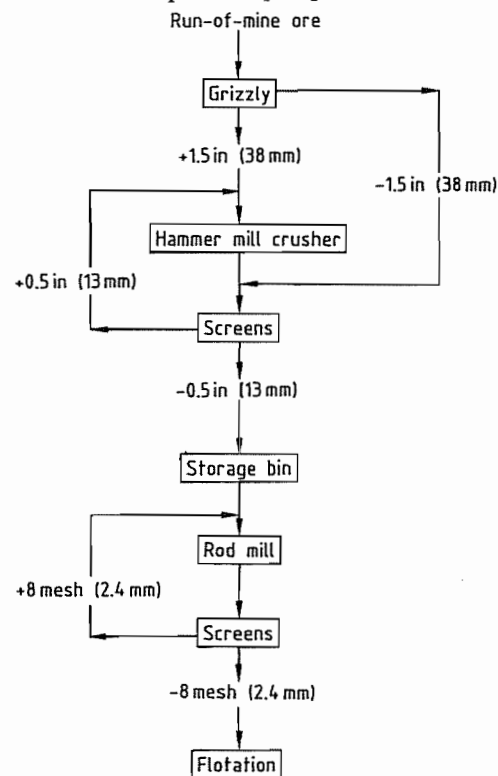

Figure 52.5: Wet grinding and screening of coarsely intergrown potash ore for flotation [83]. Reprinted with permission of the Society for Mining, Metallurgy, and Exploration, Inc.

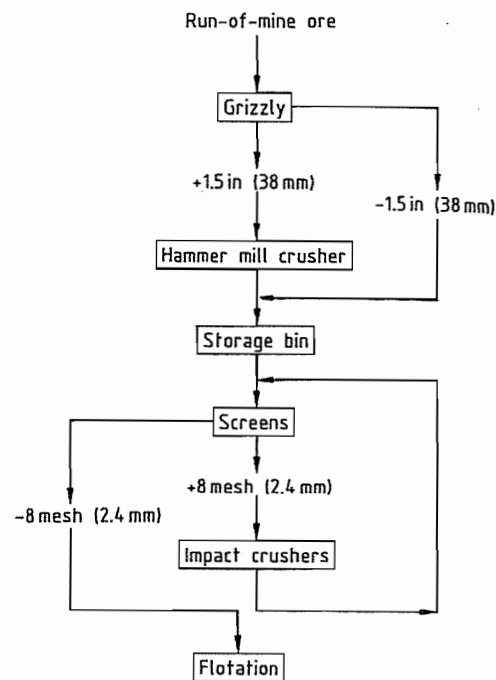

Figure 52.6: Dry grinding and screening of coarsely intergrown potash ore for flotation [83]. Reprinted with permission of the Society for Mining, Metallurgy, and Exploration, Inc.

#### 52.4.4 Potash-Magnesia

Crops sensitive to chloride can be fertilized with potassium sulfate alone or by fertilizers containing the sulfates of potassium and magnesium. These consist either of a mixture of the two sulfates or of the double sulfates schönite, leonite, or langbeinite in dehydrated form.

Formerly, large quantities of a mixture of fine-grained potassium sulfate and kieserite were marketed under the name potash-magnesia ( $K_2O$ : 27–30%,  $MgO$ : 9–12%). This has since been almost completely replaced by a granulated potash magnesia fertilizer, which is produced by first mixing potassium sulfate and kieserite at 95 °C with hot synthetic langbeinite. The hot mixture is granulated in a drum granulator, and the product is quickly cooled to < 60 °C. It contains 29–30%  $K_2O$  and 10%  $MgO$ .

Langbeinite from the potash deposits in Carlsbad, New Mexico (United States), can be used in the pure state directly as a potash magnesia fertilizer. Crude langbeinite also contains halite and varying amounts of sylvite, and the method of purification utilizes the low rate of dissolution of langbeinite in water. If the sylvite content is low, the potash ore is first ground to < 6 mm and then simply washed with water to dissolve the halite. The langbeinite that remains is dried and screened to obtain the commercial size gradings. For higher sylvite content, an additional stage is required to separate the components by a combination of gravity separation and flotation. The langbeinite produced has a  $K_2O$  content of 20–22% and an  $MgO$  content of 18–19%, and is marketed as Sulpomag or K-Mag.

#### 52.4.5 Production of Potassium Salts from Other Raw Materials

Potassium salts occur not only in salt deposits, but also in solution in many types of inland lakes and in seawater. Where the concentration of the salt solution is high enough and the climatic and topographical conditions are suitable, potassium chloride or potassium sulfate can be produced by solar evaporation. Typical analyses of some of the more important sources are listed in Table 52.6.

Table 52.6: Composition of some natural brines compared with seawater (in %).

|             | Dead Sea | Wendover brine | Great Salt Lake | Seawater |
|-------------|----------|----------------|-----------------|----------|
| $K^+$       | 0.6      | 0.6            | 0.7             | 0.04     |
| $Na^+$      | 2.9      | 9.4            | 7.6             | 1.08     |
| $Mg^{2+}$   | 3.4      | 0.4            | 1.1             | 0.13     |
| $Ca^{2+}$   | 1.3      |                | 0.016           | 0.04     |
| $Cl^-$      | 17.0     | 16.0           | 14.1            | 1.94     |
| $SO_4^{2-}$ | 0.04     | 0.2            | 2.0             | 0.27     |
| $Br^-$      | 0.5      |                | 0.01            | 0.006    |
| $H_2O$      | 74.3     | 73.3           | 74.5            | 96.5     |

##### 52.4.5.1 The Dead Sea

Potash production by solar evaporation began at the northern end of the Dead Sea in 1931. Later, production switched to the south-

ern end but was interrupted by the war of 1947–1948. In 1952, potash production was resumed in Sodom by the Israeli State *Dead Sea Works*. The capacity was built up in several stages and now amounts to  $> 2 \times 10^6$  t of potassium chloride in all the usual commercial grades [260, 261].

Brine from the lake is concentrated in evaporation ponds with a total area of ca. 90 km<sup>2</sup>, from which the crystallized salts are recovered. Most of the dissolved sodium chloride separates out first in the primary evaporation ponds. A mixture of carnallite and sodium chloride then crystallizes in the main production ponds. This is removed as a suspension by suction dredgers and pumped to the works where the crystals are filtered off and treated by the carnallite cold decomposition process. Most of the resulting  $NaCl-KCl$  mixture is then treated in a hot leaching plant, where potassium chloride with > 60%  $K_2O$  is produced in crystallizers. Part of the crop of crystals from the main production ponds is treated by a cold crystallization process developed by the Dead Sea Works. This decomposition process directly yields a product containing > 60%  $K_2O$ .

A potash works was started by the *Arab Potash Co.* in 1982 on the southeast bank of the Dead Sea near Safi, Jordan. Evaporation and carnallite production are carried out in a pond system with a total area of 100 km<sup>2</sup>. The process resembles that of the Dead Sea Works. Magnesium chloride is removed from carnallite in a cold decomposition process, and the salt mixture formed is then treated in a hot leaching plant to give potassium chloride [260, 262].

##### 52.4.5.2 The Great Salt Lake [263]

The Great Salt Lake is the result of the shrinkage by evaporation of the former Lake Bonneville and lies in the eastern part of the basin. It has a high salt content and is the reason for the existence of several plants that produce sodium chloride and, since 1968, potassium salts.

At the western end of the Great Salt Lake, in the Great Salt Lake Desert near Wendover, are the Bonneville Salt Flats. Here, under a salt crust, are porous sediments containing brines, which are regenerated by water from atmospheric precipitation. Potassium chloride has been produced from these brines since 1937. They are collected by a system of ditches and evaporated in ponds. A mixture of potassium and sodium chloride crystallizes, from which potassium chloride is obtained by flotation [264].

Unlike the Wendover brines, the Great Salt Lake brines contain considerable amounts of sulfate (see Table 52.6). The process used in Wendover cannot therefore be used here. The opportunity exists of obtaining substantial quantities of valuable potassium sulfate rather than potassium chloride, which has been carried out since 1970 in the Great Salt Lake Minerals & Chemicals Corporation (GSLM & CC) plant at Ogden on the east bank. Sodium chloride is first crystallized in the 56-km<sup>2</sup> pond system until the solution is saturated in potassium salts. Further solar evaporation then takes place in the main production ponds, producing a mixture containing varying proportions of kainite, carnallite, and schönite, with small amounts of sodium chloride [265]. This mixture is converted into schönite in the plant by treatment with recycled process brine. The sodium chloride that is not dissolved by this reaction must be removed before further treatment. This is carried out by flotation of a side stream [180]. Schönite is then decomposed by water, which produces very pure potassium sulfate. The brine from this decomposition stage has a high potassium content and is recycled to the first stage of the process. The brine produced by the reaction at this stage is recycled to the evaporation pond. The sulfate content of the main crop of crystals is higher than the potassium content, so that further potassium sulfate can be produced by addition of potassium chloride from an external source [266].

The level of the Great Salt Lake increased so much during the 1970s and 1980s that the pond system of the Great Salt Lake Minerals

& Chemicals Corporation (GSLM & CC) overflowed during 1984, and production had to stop [267]. The lake level then fell, the pond system was reinstated, and production started again in 1989.

### 52.4.5.3 Searles Lake [268]

In Trona, on the northwest bank of the almost dry Searles Lake, brines are obtained that contain not only sodium and potassium chlorides, but also considerable quantities of sulfate, carbonate, and borate ions. Recycled process brines are first added, and evaporation produces sodium chloride and the double salt burkeite, Na<sub>2</sub>CO<sub>3</sub>·3Na<sub>2</sub>SO<sub>4</sub>. Potassium chloride is obtained by vacuum cooling of the potassium- and borate-containing mother liquor. Part of the chloride is reacted with part of the burkeite to form glaserite, Na<sub>2</sub>SO<sub>4</sub>·3K<sub>2</sub>SO<sub>4</sub>, an intermediate stage in potassium sulfate production. Another reaction used for potassium sulfate production is that of potassium borate in the end brines with sulfuric acid, to form potassium sulfate and boric acid:

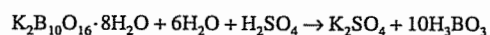

### 52.4.5.4 Other Sources

In addition to the sources mentioned under potassium sulfate, other salt lakes exist whose potassium content would appear to offer the possibility of extracting potassium salts. In 1969 at Lake McLeod in Western Australia, a works produced langbeinite, K<sub>2</sub>SO<sub>4</sub>·2MgSO<sub>4</sub>, for a short period of time but ceased operations for unknown reasons. In China, in the Qinghai Province, potassium chloride production has been carried out for several years at Tsarhan Lake by using solar evaporation. Large increases in production are planned [269].

Seawater has a low potassium content (Table 52.6) so that economical extraction of potassium salts is not possible. The production of sea salt by solar evaporation in salt gardens yields residual brines with increased potassium content. In some places (e.g., India), small quantities of low-percentage potassium

salts are produced from these bitterns. However, economical production of potash fertilizers of marketable quality is not possible from the amounts of mother liquor available from even the largest sea salt producers.

## 52.5 Production of the Metal

Potassium was first obtained by H. DAVY in 1807 by electrolysis of potassium hydroxide. Historically, Degussa operated an electrolytic process developed in the 1920s with an electrolyte of 66% KOH, 19% K<sub>2</sub>CO<sub>3</sub>, and 15% KCl. Later, use was made of a salt mixture (melting point approximately 600 °C) of potassium chloride and potassium fluoride with a few percent of potassium carbonate [4]. Application of the Down's electrolytic sodium process to produce potassium has not been successful.

On the laboratory scale, potassium can be prepared using the following reactions:

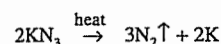
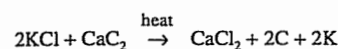
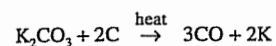

However, these reactions are not easily adaptable to a commercial scale.

Currently in industry, chemical reduction is preferred over electrolytic processes for potassium production. Mine Safety Appliances Company (MSA, USA) developed a reduction process using sodium and KCl to produce potassium metal in the 1950s at Callery, Pennsylvania [5].

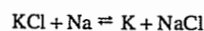

The technology is based on the rapid equilibrium established between sodium, potassium, potassium chloride and sodium chloride at high temperatures. The equilibrium shifts to the product side when potassium is removed continuously by distillation through a packed column. This process can produce high purity potassium metal. Appropriate adjustments of

conditions give a wide range of potassium-sodium alloys of specified compositions.

The commercial production equipment consists of a furnace, heat-exchanger tubes, a fractionating column packed with Raschig rings, a KCl feed, a waste-removal system, and a vapor-condensing system (see Figure 52.7).

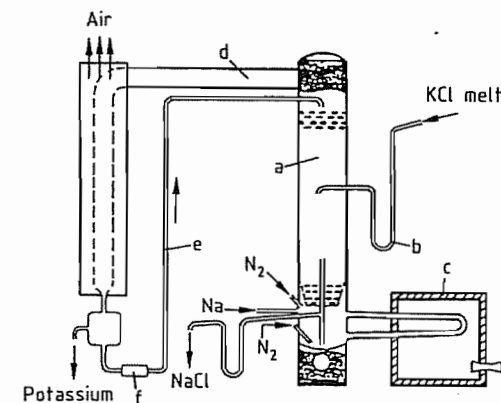

Figure 52.7: Commercial production of potassium: a) Packed column; b) Trap; c) Furnace; d) Condenser; e) Reflux; f) Electromagnetic pump.

During operation, KCl is melted and introduced through a trap to the column. Molten sodium is fed to the bottom of the column. The lower portion of the column serves as a reactor whereas the upper portion is a fractionator. Potassium vapor is fractionated and condensed in an air-cooled condenser with the reflux pumped back to the top of the column. Waste sodium chloride is continuously removed from the bottom of the column through a trap.

## 52.6 Analytical and Test Methods

The only major impurity in potassium metal is sodium. Potassium's purity can be accurately determined by a melting point test (Figure 52.8) or atomic absorption after quenching with alcohol and water. Traces of nonmetallic impurities such as oxygen, carbon, and hydrogen can be determined by chemical and physical methods [7].

## 52.7 Economic Aspects

Total U.S. production of potassium is less than 500 metric tons per year. There are few commercial producers worldwide, although some companies produce potassium for their own needs. The more prominent producers are Callery Chemical Company (a division of Mine Safety Appliances Company), USA, and China. Potassium may be manufactured in Russia as well. Strem Chemicals (USA) supplies small quantities in ampoules.

Prices (1996) are as follows:

|                 |            |
|-----------------|------------|
| Bulk potassium  | \$40–60/kg |
| As NaK (78 % K) | \$15–30/kg |

Potassium up to 99.99% purity can be produced by zone refining or further distillation of commercial potassium. Technical grade potassium (minimum 99% purity) is packaged under nitrogen.

## 52.8 Health and Safety Factors

Reactions of potassium with water and oxygen are violent to explosive, therefore safe handling is a concern. Potassium oxidizes slowly in air at room temperature, but it usually ignites if molten potassium sprays into the air. The peroxide and superoxide products may explode in contact with free potassium metal or organic materials including hydrocarbons. Thus, packaging under oils is less desirable than packaging with inert cover gas or vacuum because potassium can react with entrapped air in oils to form superoxide. The incrustation of potassium with superoxide (as a yellow crust) developed during storage has been known to detonate by friction from cutting. Potassium incrustated with peroxide and superoxide should be destroyed immediately by careful, controlled disposal [8].

Potassium forms corrosive potassium hydroxide and liberates explosive hydrogen gas upon reaction with water and moist air. Airborne potassium dusts or potassium combustion products attack mucous membranes and skin causing burns and skin cauterization. In-

halation and skin contact must be avoided. Safety goggles, full face-shields, respirators, leather gloves, and fire-resistant clothing and a leather apron are considered minimum safety equipment.

Steam treatment of equipment under nitrogen or argon may be used to destroy potassium residues. It is imperative that equipment be designed to permit substantially complete drainage of potassium metal prior to steam cleaning. Precautions must also be taken to avoid hydrogen-air explosions by using an inert cover gas. Small quantities of the metal can be safely destroyed under nitrogen by adding *tert*-butanol or high boiling alcohols, followed by methanol and then water. The caustic aqueous potassium waste should be disposed of in compliance with local regulations.

**Fire Fighting.** Potassium metal reacts violently with water releasing flammable, explosive hydrogen gas. Dry soda ash, dry sodium chloride, or Ansul's Met-L-X should be used to extinguish potassium or potassium alloy fires. Water, foam, carbon dioxide or dry chemical fire extinguishers should never be employed. A NIOSH/MSHA approved self-contained breathing apparatus with full facepiece operated in a positive pressure mode and full protective clothing should be worn when removing spills and fighting fire.

**Packaging and Shipping.** Potassium of 98–99.5% purity is supplied in carbon steel or stainless steel drums and cylinders under nitrogen cover. Sodium-potassium alloy is shipped in carbon or stainless steel containers (3, 10, 25, 200, 750 lbs) with dip-tubes and valves. Commercially, the eutectic composition of 78% K, 22% Na (melting point of  $-12\text{ }^{\circ}\text{C}$ ) is most commonly handled, but other ratios of sodium and potassium are available.

Transport regulations are as follows [6]:

| Metal/alloy             | Identification number |
|-------------------------|-----------------------|
| Potassium               | UN 2257               |
| Potassium-sodium alloys | UN 1422               |

Potassium and the alloys are classified as "water-reactive" (Hazard Class 4.3) by U.S. Department of Transportation regulations. A

blue background label with a "Flame" pictogram, the words "dangerous when wet", and the number 4 are required for ground transportation. The words "dangerous when wet" are omitted for air and ocean shipment labels. Quantities less than 1 kilogram may be shipped via United Parcel Service (UPS), packaged in mandatory exemption packaging specified in UPS's *Guide for Shipping Ground and Air Hazardous Materials* (1995). Larger quantities are shipped in DOT Specification 4BW240 cylinders via common carrier, regulated under 49 CFR. Air shipments are restricted to cargo air craft only, 15 kg (max.) and packaged under packing instruction 412 of IATA "Dangerous Goods Regulations" (37th ed., 1996) or ICAO "Technical Instructions for the Safe Transport of Dangerous Goods by Air" (1995–1996).

## 52.9 Potassium-Sodium Alloys

Potassium-sodium alloys represent a commercial use for direct reaction of potassium metal. The alloys (called NaK alloy or "nack" in the USA) are liquid at ambient temperature over the weight percent range of 40–90% potassium (Figure 52.8). The physical properties such as excellent thermal and electrical conductivities combined with the wide range of compositions in a liquid state, render the alloys ideal for use as heat-exchange fluids [17–19], cooling liquids in hollow valve stems [20], contact liquids for high temperature thermostats and homopolar generators, and hydraulic fluids [21]. Potassium or potassium-sodium alloys had been used as working fluids on a power plant topping cycle during the 1940s and 1950s.

Potassium alloyed with other metals generates compounds of lower reactivity than potassium metal. Most intermetallic compounds are less ductile than the pure metal. Another low melting alloy of interest is a ternary eutectic (3% Na, 24% K, 73% Cs) which melts at  $-76\text{ }^{\circ}\text{C}$ .

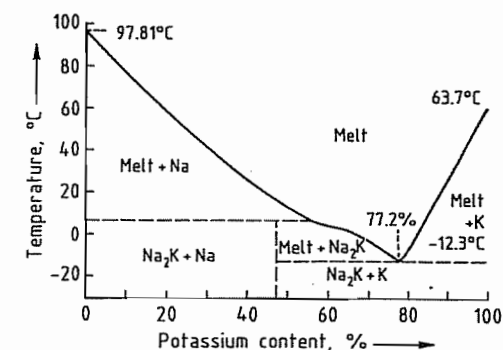

Figure 52.8: Sodium-potassium thermal equilibrium diagram [22].

The eutectic at 77.8% potassium has a freezing point of  $-12.56\text{ }^{\circ}\text{C}$ . The physical properties of NaK are listed below [2]:

|  |   |
|--|---|
| Composition  | 78 % K, 22 % Na                                   |
| Melting point  | $-12.6\text{ }^{\circ}\text{C}$                   |
| Boiling point  | $\approx 785\text{ }^{\circ}\text{C}$             |
| Density at 20 $^{\circ}\text{C}$                         | $0.867\text{ g/cm}^3$                             |
| 100 $^{\circ}\text{C}$                                   | 0.855   |
| 550 $^{\circ}\text{C}$                                   | 0.749   |
| Electrical resistance at $-12.6\text{ }^{\circ}\text{C}$ | $33.5\text{ }\mu\Omega\text{cm}$                  |
| 20 $^{\circ}\text{C}$                                    | 38.0  |
| Thermal conductivity at 20 $^{\circ}\text{C}$            | $2.18 \times 10^{-3}\text{ Wm}^{-1}\text{K}^{-1}$ |
| 550 $^{\circ}\text{C}$                                   | $2.62 \times 10^{-3}$                             |
| Specific heat at $-12.6\text{ }^{\circ}\text{C}$         | $0.975\text{ Jg}^{-1}\text{K}^{-1}$               |
| 100 $^{\circ}\text{C}$                                   | 0.937   |

The liquid NaK alloy, usually used as a dispersion and on an inert support, provides a more reactive surface area than either potassium or sodium metal alone, thus enhancing its reactivity and permitting reaction to proceed at low temperatures (e.g.,  $-12\text{ }^{\circ}\text{C}$ ). NaK alloys are suitable for chemical reactions involving unstable intermediates such as carbanions and free radicals.

NaK alloys have been used successfully in the following applications: side-chain alkylation of toluenes and xylenes [23], isomerization of  $\alpha$ -olefins to internal olefins [24, 25], free-radical [26] and condensation [27–30] polymerization, reduction of metal halides to highly reactive metal powder [31], reduction of organic functional groups such as arenes, ketones, aldehydes and alkyl halides [32, 33], cleavage of functional groups containing C-X, C-O, O-S bonds [34–38], interesterification of tallow with cotton seed oil to improve the pour and clarification temperatures [39,

40], and impurity scavenging of acetylenic and allenic contaminants [41].

## 52.10 Uses

The understanding of potassium chemistry has been greatly expanded over the last 30–40 years [9–16] and has led to numerous important industrial applications. Potassium, potassium–sodium alloys, and potassium derivatives (alkoxides, amides, and hydride) are extensively used both industrially and academically, to synthesize organic and inorganic materials. Some key applications are highlighted in the following sections.

### 52.10.1 Potassium Bases

Potassium bases are prepared synthetically by reaction of the metal with alcohols and amines.

**Potassium Alkoxides.** The most widely used potassium bases are potassium *tert*-butoxide (KTB) and potassium *tert*-amylate (KTA). These strong alkoxide bases offer such advantages as base strength ( $pK_a$  18), solubility (Table 52.7), regio- and stereo-selectivity (due to the bulky *tert*-alkyl groups), and stability (because of the lack of  $\alpha$ -protons). Solid KTB and KTA have long shelf lives under an inert atmosphere.

Table 52.7: Solubilities of KTA and KTB at 25 °C (%)

| Solvent                         | KTA  | KTB |
|---------------------------------|------|-----|
| Tetrahydrofuran                 | > 50 | 44  |
| 2-Methoxyethyl ether            | 47   | 42  |
| <i>tert</i> -Butyl methyl ether | ≈ 30 | 2.0 |
| Toluene                         | 36   | 2.3 |
| Cyclohexane                     | 27   | 0.4 |
| Hexane                          | 30   | 0.3 |

KTB and KTA are superior to alkali metal hydrides for deprotonation reactions because they have good solubilities, produce no hydrogen, and leave no oil residue. Furthermore, reactions of KTA and KTB can be performed in hydrocarbon solvents as sometimes is required for mild and nonpolar reaction conditions. Potassium alkoxides [42] are used in large quantities for condensation, esterification, transesterification, isomerization and

alkoxylation reactions. In combination with butyl lithium, KTB or KTA acts as a “super-base” forming potassium carbanions [13, 43].

**Potassium Amides.** The strong, extremely soluble, stable and non-nucleophilic potassium amide base, potassium hexamethyldisilazane (KHMDS),  $KN[Si(CH_3)_3]_2$  ( $pK_a$  28), was recently commercialized [44]. Available in both THF and toluene solutions, KHMDS is ideal for regio- and stereo-specific deprotonation and enolization reactions. It has demonstrated benefits for reactions involving kinetic enolates [45], alkylation and acylation [46], Wittig reaction [47], epoxidation [48], Ireland-Claisen rearrangement [49], isomerization [50], Darzen reaction [51], Dieckmann condensation [52], cyclization [53], chain [54]/ring expansion [55], and elimination [56].

Potassium 3-aminopropylamide, (KAPA),  $KNHCH_2CH_2CH_2NH_2$  ( $pK_a$  35), can be prepared by the reaction of 1,3-diaminopropane with potassium metal or potassium hydride [57–59]. KAPA powder has been known to explode during storage under nitrogen in a drybox, and is therefore made in situ. KAPA is extremely effective in converting an internal acetylene or allene group to a terminal acetylene [60].

### 52.10.2 Potassium Graphite (C<sub>8</sub>K)

Potassium, rubidium, and cesium react with graphite and activated charcoal to form intercalation compounds: C<sub>8</sub>M, C<sub>24</sub>M, C<sub>36</sub>M, C<sub>48</sub>M and C<sub>60</sub>M [61, 62]. Gold colored flakes of potassium graphite, C<sub>8</sub>K, are prepared by mixing molten potassium with graphite at 120–150 °C under an inert atmosphere.

Potassium graphite is a powerful solid reducing agent because of the free electrons from the ionized potassium trapped inside the graphite lattice. In packed columns or beds, it can effectively eliminate undesired organic contaminants such as halogenated hydrocarbon impurities from gas streams and liquid solutions. The scope of its reducing reactions include [61]: Birch-type reactions of  $\alpha$ - and  $\beta$ -unsaturated ketones, carboxylic acids, and

Schiff's bases; reductive cleavage of vinylic and allylic sulfones; selective alkylation of aliphatic esters, imines, and nitriles; and reductive decyanation of nitriles. Potassium graphite has been used to prepare active metals supported on graphite [62]: Zn–Gr for Reformatsky reactions, Sn–Gr for allylic organometallics, Ti–Gr for coupling carbonyl compounds, Fe–Gr for debromination, Pd–Gr for vinylic and allylic substitution, and Pd–Gr, Ni–Gr for hydrogenation, etc. Potassium graphite has also been applied in polymerization reactions [63].

### 52.10.3 Potassium Hydride

Potassium hydride, KH is made from reaction of molten potassium metal with hydrogen at about 200 °C or at lower temperatures with a catalyst [64]. Pressure Chemical Company (USA) is a major supplier of KH in an oil dispersion. KH is much more effective than NaH or LiH for enolization reactions [65]. KH used as a base and nucleophile is reviewed elsewhere [66].

A noteworthy development is the use of KH for complexing alkylboranes and alkoxyboranes to form mild reducing agents used in the pharmaceutical industry. Potassium tri-*sec*-butylborohydride,  $KB[CH(CH_3)C_2H_5]_3H$  and potassium tri-*sec*-amylborohydride  $KB[CH(CH_3)CH(CH_3)_2]_3H$  are made by complexing KH with tri-*sec*-butylborane and tri-*sec*-amylborane respectively. Potassium tri-*iso*-propoxyborohydride can be made by the reaction of KH with isopropyl borate [67].

The potassium trialkylborohydrides find a variety of uses as selective reducing agents [68]. Because of their bulky nature, they exhibit high stereoselectivity in the reduction of hindered cyclohexenones [69]. Regioselective reduction of unsymmetrical cyclic anhydrides by trialkylborohydrides delivers lactones [70]. Potassium tri-*sec*-butylborohydride cleanly reduces  $\alpha$ - and  $\beta$ -unsaturated enones in a 1,4-addition to give ketones [71]. In addition, potassium trialkylborohydrides and potassium triisopropoxyborohydride

have been used in organometallic synthesis [72].

### 52.10.4 Potassium Superoxide

Potassium, rubidium and cesium form superoxide (MO<sub>2</sub>) upon oxidation by oxygen or air. However, sodium gives the peroxide, Na<sub>2</sub>O<sub>2</sub>, while lithium yields the oxide, Li<sub>2</sub>O, when oxidized under comparable conditions. Mine Safety Appliances Company first developed potassium superoxide (KO<sub>2</sub>) for use as an oxygen source in self-contained breathing equipment since it liberates oxygen in contact with moisture and carbon dioxide [73].

The unique chemical behavior of KO<sub>2</sub> is a result of its dual character as a radical anion and a strong oxidizing agent [74]. The reactivity and solubility of KO<sub>2</sub> is greatly enhanced by a crown ether [75]. Its usefulness in furnishing oxygen anions is demonstrated by its applications in SN<sub>2</sub>-type reactions to displace methanesulfonate and bromine groups [76], the oxidation of benzylic methylene compounds to ketones [77], and the syntheses of  $\alpha$ -hydroxyketones from ketones [78].

## 52.11 Potassium Chloride

Potassium chloride, KCl, mineral name sylvite, forms colorless nonhygroscopic crystals. It occurs in many salt deposits (see Section 52.4.1.2) mixed with halite and other salt minerals. Natural sylvite is usually opalescent or milky white, as are crystals obtained from an aqueous solution. Sylvite is often colored red by hematite. With magnesium chloride it forms the double salt carnallite,  $KCl \cdot MgCl_2 \cdot 6H_2O$ , which is also commonly found in salt deposits. Potassium chloride is produced in large quantities from mined potash ores and from salt-containing surface waters. More than 90% of the potassium chloride produced is used in single- or multi-nutrient fertilizers, either directly or after conversion to potassium sulfate. The remainder has various industrial uses and is the raw material for the manufacture of potassium and its compounds.

### 52.11.1 Properties

Potassium chloride crystallizes in the cubic system, usually as actual cubes. Some physical properties described are as follows:

|   |   |
|---|---|
| Melting point                               | 771 °C                                    |
| Crystal system and type                     | cubic, $O_h^5$                            |
| Refractive index $n_D^{20}$                 | 1.4903                                    |
| Density                                     | 1.987 g/cm <sup>3</sup>                   |
| Specific heat $c_p$                         | 693.7 J kg <sup>-1</sup> K <sup>-1</sup>  |
| Heat of fusion                              | 337.7 kJ/kg                               |
| Enthalpy of formation DH0                   | -436.7 kJ/mol                             |
| Entropy S0                                  | 82.55 J mol <sup>-1</sup> K <sup>-1</sup> |
| Dielectric constant (at 106 Hz)             | 4.68                                      |
| Thermal coefficient of expansion (15–25 °C) | $33.7 \times 10^{-6}$ K <sup>-1</sup>     |

Solubilities in water at various temperatures appear in Table 52.8, and the phase diagram of the system KCl–H<sub>2</sub>O is shown in Figure 52.9.

Table 52.8: Solubility of potassium chloride in water (G/100 g) [94].

| Temperature, °C | Solubility | Temperature, °C | Solubility |
|-----------------|------------|-----------------|------------|
| 0               | 28.1       | 60              | 45.9       |
| 10              | 31.2       | 70              | 48.6       |
| 20              | 34.2       | 80              | 51.3       |
| 30              | 37.2       | 90              | 53.8       |
| 40              | 40.2       | 100             | 56.2       |
| 50              | 43.1       |                 |            |

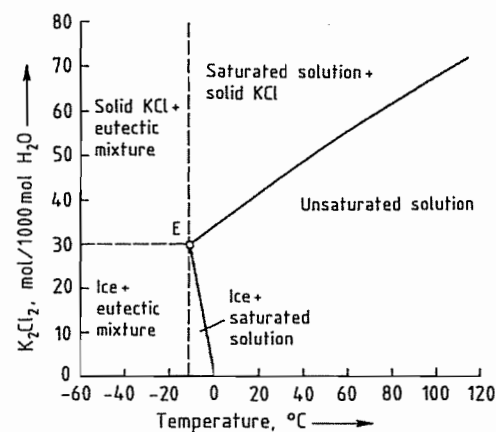

Figure 52.9: Solubility curves for potassium chloride in water. E = cryohydric point: Ice–potassium chloride solution.

In the system KCl–H<sub>2</sub>O, the only solid phases formed are KCl and ice. The cryohydric point (ice + KCl) is -10.7 °C (29.7 mol K<sub>2</sub>Cl<sub>2</sub>/1000 mol H<sub>2</sub>O). The boiling point of the saturated solution at 1.013 bar is 108.6 °C (71.6 mol K<sub>2</sub>Cl<sub>2</sub>/1000 mol H<sub>2</sub>O).

### 52.11.2 Production by Crystallization from Solution

#### 52.11.2.1 Phase Theory

The salt deposits were formed by the evaporation of seawater, which contains the principal ions Na<sup>+</sup>, K<sup>+</sup>, Mg<sup>2+</sup>, Ca<sup>2+</sup>, Cl<sup>-</sup>, and SO<sub>4</sub><sup>2-</sup>. With water, these ions constitute a six-component system. The concentration of Ca<sup>2+</sup> in the most interesting region of the system is negligibly small, so that the system reduces to quinary. It is nevertheless very complicated with, 23 different salts being formed between 0 and 100 °C, depending on the temperature and the ratio of concentrations of the components.

Understanding how the salt deposits were formed and how they behave in dissolution processes requires knowledge of the solution equilibria.

The theoretical foundations for this were laid by VAN'T HOFF et al., who between 1896 and 1906 investigated the formation of oceanic salt deposits [133]. Many investigators have continued this work up to the present.

J. D'ANS critically evaluated all published data up to 1933, expressing his results in graphical form [134]. In the same book, he described experimental methods for determining solution equilibria and gave recommendations for the graphical representation of experimental results [135].

Much of the equilibrium data published up to 1967 are given in [136, 137].

In the years following World War II, in the Kaliforschungs-Institut (Potash Research Institute) of Hannover, AUTENRIETH carried out comprehensive and detailed research into the stable and metastable equilibria of most relevance to potash production (especially from hard salt), giving the results in a form suitable for practical application [138–144].

The intensive investigations carried out into the quinary system make it the most thoroughly investigated system with more than four components. However, only parts of the system that are of most relevance to potash production have been thoroughly investigated.

An obstacle in the application of equilibrium data to practical problems is that such a complex system is very difficult to represent in a two-dimensional diagram. However, by fixing parameters, working with projections on a plane, and using diagrams showing lines of constant parameters, even nonexperts can work with them.

The best-known region is that in which the solutions are saturated with sodium chloride. This is also the most important region for potassium chloride manufacture, both by the hot leaching process and by flotation, because in both cases a solution saturated with sodium chloride is used. The most important part of the so-called NaCl saturation space at 25 °C is shown in Figure 52.10 as a three-dimensional view.

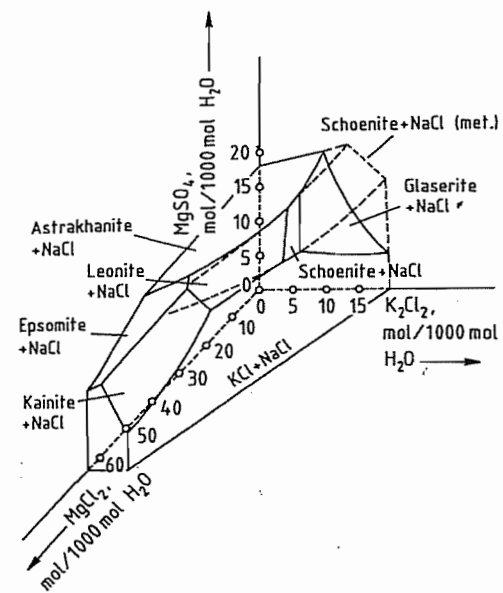

Figure 52.10: Three-dimensional view of the quinary system (saturated with NaCl) at 25 °C with 0–65 mol MgCl<sub>2</sub>/1000 mol H<sub>2</sub>O showing stable and metastable regions.

Each point in the interior of this space corresponds to a solution saturated with NaCl, in which the concentrations of MgCl<sub>2</sub>, K<sub>2</sub>Cl<sub>2</sub>, and MgSO<sub>4</sub> are given by the distance of the point from the axes. For practical reasons, the concentration figures are given in moles per 1000 mol of H<sub>2</sub>O, and the concentrations of

KCl and NaCl are given in double moles. If one or more of the salt concentrations increase, and if the saturation concentration of another salt is exceeded, this salt separates out. Its identity depends on the concentration ratio in the solution. Such two-salt solutions (saturated with two salts) lie on two-salt surfaces, which form the boundaries of the saturation space. Of the twelve other salts whose saturation spaces form the boundary of the NaCl saturation space, seven can be seen on the figure because their two-salt surfaces lie in the concentration range of Figure 52.10.

The KCl–NaCl two-salt surface on the front side of Figure 52.10 is of special significance for the potash industry, because it allows solutions to be made up that are saturated with both salts at 25 °C. Such solutions are important in the treatment of sylvinitic potash ores.

In many instances, a salt does not crystallize spontaneously when its concentration exceeds that indicated on a two-salt surface. Instead, highly supersaturated solutions are formed, which can remain stable for hours or days, depending on temperature and composition. These supersaturated solutions are termed metastable. They become stable saturated solutions by crystallization of a salt. In Figure 52.10, continuations of the stable schönite–NaCl two-salt surface to the right and left into the unstable region are shown as broken lines. In potash manufacture, stable solution equilibria are seldom attained. This is particularly true for hard salt processing in which NaCl-saturated solutions with high MgSO<sub>4</sub> content often lead to the undesired crystallization of double sulfates such as schönite, leonite, langbeinite, and glaserite. Here, the rates of dissolution, nucleation, and crystallization of these salts as a function of temperature and composition of the solutions are especially important [142–144].

For practical application of equilibrium data, the boundary surface of the NaCl saturation space is projected, for example, in the direction of the K<sub>2</sub>Cl<sub>2</sub> axis in the MgSO<sub>4</sub>–MgCl<sub>2</sub> plane. In Figure 52.11, the two-salt surface NaCl–KCl for the stable and metastable 25 °C

isotherm is shown. The indicated  $K_2Cl_2$  and  $Na_2Cl_2$  lines of constant concentration enable the complete composition to be read off for each of the solutions shown here. By using this diagram, the dissolution and crystallization processes possible in this part of the quinary system can be described quantitatively. To control the crystallization of potassium chloride from 90 °C solutions in an industrial plant, for example, the most important boundary surfaces of the 90 °C isotherm of the system (Figure 52.12) are additionally required.

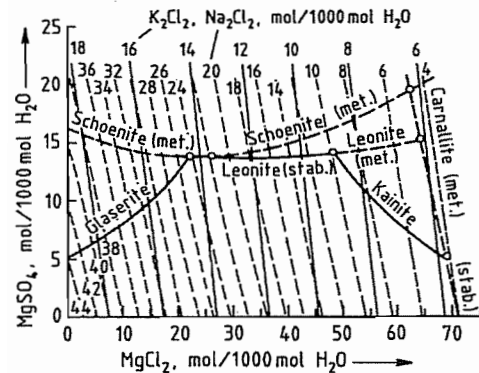

Figure 52.11: 25 °C isotherms of the quinary system saturated with NaCl. Stable (—) and metastable (---) surfaces saturated with KCl and NaCl. Concentrations of  $K_2Cl_2$  (---) and  $Na_2Cl_2$  (---) are indicated by lines of equal concentration.

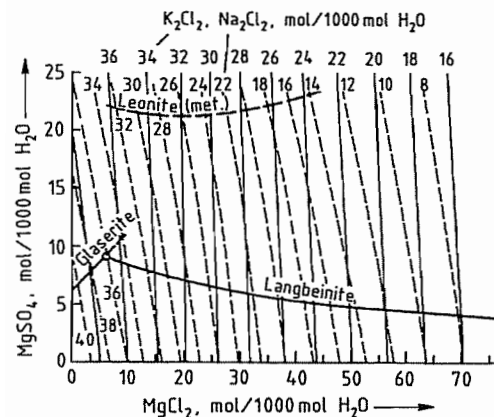

Figure 52.12: 90 °C isotherms of the quinary system saturated with NaCl. Stable (—) and metastable (---) surfaces saturated with KCl and NaCl. Concentrations of  $K_2Cl_2$  (---) and  $Na_2Cl_2$  (---) are indicated by lines of equal concentration.

If any of the components of the quinary system are present in such small quantities that they have a negligible effect on the process, the mathematical treatment can be simplified by dealing only with the remaining subsystem. The following subsystems are of importance:

- $Na^+$ ,  $K^+$ ,  $Mg^{2+}$ ,  $Cl^-$ , and  $H_2O$  with NaCl saturation (see Figure 52.19) for the conversion of carnallite into potassium chloride and bischofite
- $K^+$ ,  $Mg^{2+}$ ,  $Cl^-$ , and  $H_2O$  (see Figure 52.18) for the decomposition of carnallite
- $Na^+$ ,  $K^+$ ,  $Cl^-$ , and  $H_2O$  [135] for the selective dissolution of NaCl (e.g., from crystalline product obtained from hard salt in the hot leaching process)
- $K^+$ ,  $Mg^{2+}$ ,  $Cl^-$ ,  $SO_4^{2-}$ , and  $H_2O$  [139] for the production of potassium sulfate and potash-magnesia
- $Na^+$ ,  $Mg^{2+}$ ,  $Cl^-$ ,  $SO_4^{2-}$ , and  $H_2O$  [135] for the production of thenardite or Glauber's salt

### 52.11.2.2 Hot Leaching Process

The hot leaching process is the oldest industrial process used to produce potassium chloride from potash ore. It was first used in 1860 in Stassfurt and since then has been developed further in Germany, where it is still the dominant process. It is especially suitable for treating very finely intergrown ores or ores that contain other salt minerals or insoluble minerals in addition to the sylvite and halite. It enables a high-purity product with a uniform grain size to be produced. In many plants, especially in Canada, where flotation is the main production process, small hot leaching plants are also operated, in which the product fines (< 0.2 mm) are recrystallized, or potassium chloride is extracted and crystallized from the flotation residues or thickened clay slurries. These procedures give a considerable improvement in total yield and result in a very pure, completely water-soluble product.

Two different processes are used, depending on the composition of the ore. In the *sylvinitic* hot leaching process, the other salts

present in addition to KCl and NaCl play only a minor role in the process solutions. In *hard salt* leaching, process solutions contain appreciable amounts of  $MgCl_2$  and  $MgSO_4$ . In the case of carnallite-containing hard salts, preliminary carnallite decomposition must be carried out if the amount of carnallite present exceeds a critical level.

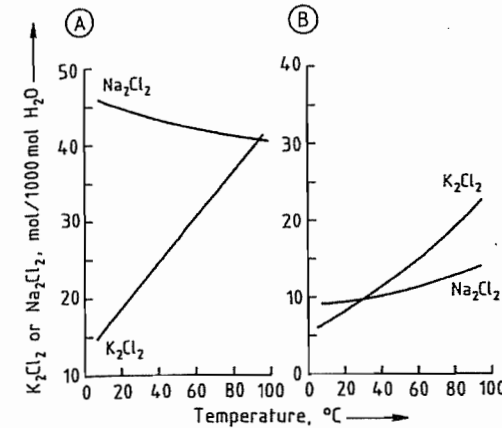

Figure 52.13: Solubility curves for KCl and NaCl (schematic). A) Sylvinitic leaching (with nonevaporative cooling); B) Hard salt leaching.

The different solubility properties of sodium chloride and potassium chloride are shown in Figure 52.13. The solubility of potassium chloride is lower in hard salt solutions than in sylvinitic solutions. The difference between the potassium chloride contents of saturated solutions at low and high temperatures is less for solutions of hard salt than for solutions of sylvinitic, so that the amount of potassium chloride that can be crystallized from a given amount of solution is smaller, which has a marked effect on the energy requirement. Furthermore, an important difference between the two solution types is that the solubility of sodium chloride in sylvinitic solutions decreases with increasing temperature, whereas it increases in hard salt solutions. This is apparent in Figure 52.13B, which shows the behavior of process solutions in a carnallitic hard salt plant with a magnesium chloride content of ca. 240 g/L. This dependence of the solubility of sodium chloride on temperature and magnesium salt content explains why the sodium

chloride contents of crystallized products differ, depending on whether they came from the treatment of sylvinitic or hard salt.

**The Process** (Figure 52.14). The potash ore, ground to a fineness of < 4–5 mm, is stirred in a continuous dissolver with leaching brine heated to just below its boiling point. The leaching brine is the mother liquor from the crystallization stage of a previous cycle of the process. The quantity of leaching brine required is determined by the amount of potassium chloride in the ore. The potassium chloride should be extracted from the ore as completely as possible, and the resulting product solution should be as nearly saturated as possible. The residue consists of two fractions of different particle size. The coarse fraction is removed from the dissolver and debrined. The fine fraction (fine residue or slime) is removed from the dissolver along with the crude solution, which is clarified with the aid of clarifying agents. The slime that separates is filtered off, and the filtrate from the coarse and fine residues is recycled to the recirculating brine. The residues are washed with water or plant brines low in potassium chloride to remove the adhering crude solution, which has a high potassium chloride content. The residues are then disposed of by dumping.

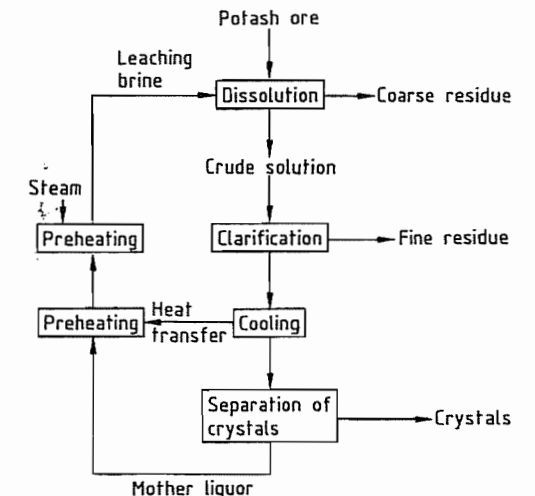

Figure 52.14: Overall schematic of a hot leaching process.

The hot, clarified, crude solution is cooled by evaporation in vacuum equipment. Potassium chloride and sodium chloride crystallize as the water is removed. The sodium chloride content of the crystals formed can be controlled by complete or partial replacement of the evaporated water during crystallization. The crystals formed are separated from the mother liquor and processed further. The mother liquor is heated and recycled to the dissolver as leaching brine.

The leaching process is usually carried out in two stages in a main dissolver and a secondary dissolver. The ground ore is first added to the main dissolver where it is mixed with the already partially saturated solution from the secondary dissolver. This causes the solution to be almost completely saturated, and it is then removed from the leaching equipment. The partly extracted ore is next fed to the secondary dissolver where it comes in contact with fresh leaching brine, and the potassium chloride that was not extracted in the main dissolver is taken up by the solution, which is then fed to the main dissolver. The leaching process in the main dissolver can be cocurrent or countercurrent (Figure 52.15).

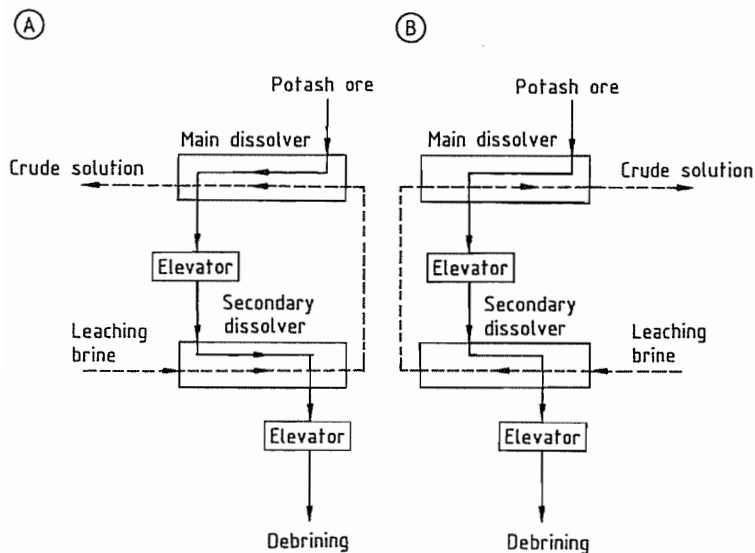

Figure 52.15: Schematic arrangements of a hot leaching apparatus. A) Cocurrent flow; B) Countercurrent flow.

The residence time in the leaching equipment is insufficient to give complete KCl-NaCl equilibrium. The crude solution always contains less potassium chloride and more sodium chloride than corresponds to equilibrium. Another reason for the potassium chloride concentration to be maintained below saturation is that complete recovery of potassium chloride from the ore is possible only if the hot solution at the end of the leaching process still has a small capacity for dissolving potassium chloride. Also, the crude solution cools by 1–2 °C as it travels from the main dissolver to the overflow from the following hot clarification stage. If the solution leaving the main dissolver were completely saturated in potassium chloride, the potassium chloride would begin to crystallize at this point, leading to losses in the slime.

For the crystallization process the potassium chloride content should be maintained as near to saturation as possible in the leaching equipment, so that the concentration difference between the mother liquor and the hot crude solution is as great as possible. The greater this difference, the smaller is the amount of solution used, and the lower is the energy consumption.

Also, a high concentration of potassium chloride in the solution leads to a high potassium chloride content in the crystalline product obtained on cooling. If the solution is unsaturated with respect to potassium chloride, a corresponding amount of sodium chloride in excess of its saturation concentration is taken up by the solution to compensate for the missing potassium chloride. This means that, on cooling, a quantity of sodium chloride crystallizes, causing a decrease in the potassium chloride content of the product even in sylvinitic solutions in which the solubility of sodium chloride increases with decreasing temperature.

Cooling the crude solution by evaporation increases the concentration of salts present below saturation, and the salts with which the solution is saturated crystallize. Unwanted crystallization of sodium chloride can be prevented by adding water to the vacuum cooling equipment, especially in the case of solutions from sylvinite ore leaching. If the required potassium chloride content in the crystalline product cannot be obtained by adding water to the solution, which is often the case when hard salt is being processed, the same result can be obtained by treating the product with cold water. A product containing 60% K<sub>2</sub>O (95% KCl) is usually required. By this cold-water treatment technique, it is even possible to obtain a product with 62% K<sub>2</sub>O (98% KCl). The spent solution is recycled to the process.

For KCl of analytical or pharmaceutical quality, potassium chloride produced by the hot leaching process must be purified by single or multiple recrystallization.

**Processing of Hard Salt.** Unlike the sylvinitic potash ores, whose principal constituents are sodium and potassium chloride, hard salts contain not only the alkali chlorides but also large amounts of kieserite, usually with varying amounts of carnallite, langbeinite, and anhydrite. Therefore, process brines produced by the leaching of hard salt are characterized by high contents of magnesium chloride and magnesium sulfate, which make potassium chloride production more difficult.

Magnesium sulfate comes mainly from kieserite, which is very soluble (Figure 52.16) but has a slow rate of dissolution that becomes even slower if large amounts of dissolved MgCl<sub>2</sub> are present. The amount of magnesium sulfate that dissolves depends on the grain size of the ore fed to the dissolving equipment, the kieserite content of the ore, the time for which the crude salt solution mixture is stirred, the temperature, and the magnesium chloride content of the brine.

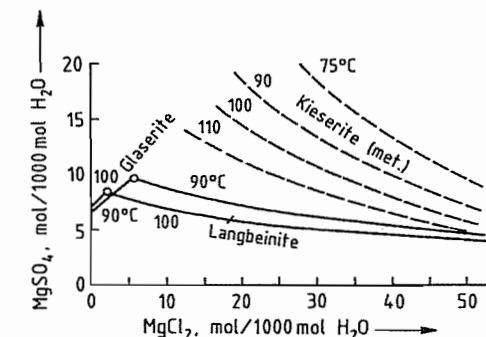

Figure 52.16: Metastable solubility of kieserite in the quaternary system saturated with KCl and NaCl between 75 and 110 °C, and solubilities of langbeinite and glaserite at 90 and 100 °C.

Magnesium chloride results from reaction of dissolved magnesium sulfate with potassium chloride to give sulfate-containing double salts, and also from any carnallite (KCl·MgCl<sub>2</sub>·6H<sub>2</sub>O) present in the hard salt. In general, the MgCl<sub>2</sub> and MgSO<sub>4</sub> contents are kept constant in the circulating brines, so that the rate at which magnesium is taken up from the ore is balanced by the rate at which it leaves the system in the residues and products. If the ore contains large amounts of carnallite, part of the circulating brine must be removed continuously from the system to prevent the MgCl<sub>2</sub> level becoming too high.

Because of the large amounts of magnesium salts in process brines, the hard salt leaching process has three important disadvantages compared with the sylvinite process:

- In solutions of hard salt, the range of solubilities is considerably less than in solutions of sylvinite (Figure 52.13). To extract a given amount of potassium chloride, much



more liquor, and hence more energy, is required compared with sylvinite.

- With solutions of hard salt, crystallization of double sulfates such as schönite, leonite, and langbeinite often occurs. These salts can appear in the residue or the product, which leads either to potassium losses in the residue or to a lower  $K_2O$  content of the product. Also, double salts can crystallize in pipelines, vessels, and pumps, interfering with the process and in extreme cases bringing it to a standstill. The particular double salt that crystallizes depends on the  $MgCl_2$  content of the solutions, the temperature, and other operating conditions (Figures 52.11 and 52.12). The extent of supersaturation with double sulfates must therefore be controlled to prevent uncontrolled crystallization of double salts and consequent introduction of impurities into the product or disturbance of the process. To achieve this, the circulating brine, or part of it, is fed to a reactor in which it is agitated intensively in the presence of nuclei (20–40%) of the double salt to be removed until the brine is no longer supersaturated with respect to it [145].

- Another disadvantage of the hard salt leaching process is that, with higher magnesium salt contents, the temperature dependence of the solubility of NaCl becomes unfavorable (Figure 52.13), that is, when the potassium chloride is crystallized by cooling, considerable amounts of sodium chloride can also crystallize (Figure 52.17). In practice, equilibrium is not completely reached when the  $KCl-NaCl$  is dissolved, and cooling of the solution often occurs by water removal, so that the  $K_2O$  content of the crystals formed is usually only a little more than 40%. Since the usual potassium chloride for fertilizers (excluding special products) has a minimum potash content of 60%  $K_2O$ , this primary product was formerly crystallized in a second leaching plant. Alternatively, a product can be made with 60%  $K_2O$  directly, if the crystallization of sodium chloride during vacuum cooling is prevented by addition of

sufficient water before or during crystallization of the solution to ensure that only potassium chloride crystallizes [145]. The  $K_2O$  content in the product of a primary crystallization can be increased to the required level by treating the product with water or a plant solution unsaturated with respect to sodium chloride. Both the excess water added during vacuum cooling and the water used for treating the product must be removed from the recirculating system of the plant. Both cause a loss of yield whose extent depends on operating conditions. To avoid this, excess water must be evaporated from process liquors.

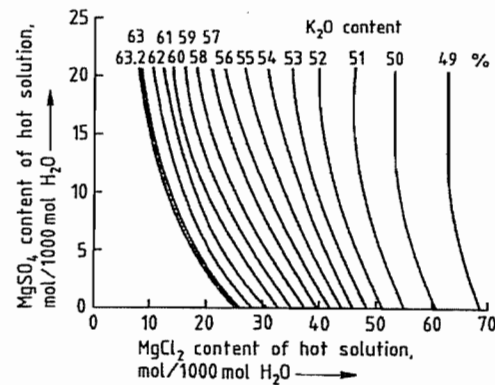

Figure 52.17:  $K_2O$  content of the crystalline product obtained by cooling an equilibrium solution saturated with NaCl and KCl from 90 to 25 °C without evaporation while maintaining saturation.

### 52.11.2.3 Processing of Carnallite

Carnallite,  $KCl \cdot MgCl_2 \cdot 6H_2O$ , is the most abundant potassium mineral in salt deposits and occurs widely in mixtures with halite or with halite and kieserite in the form of carnallite ore. In the early days of the potash industry in Germany, it was the preferred starting material for the production of potassium chloride. Today, sylvinitic ores and hard salts are used almost exclusively, because the extraction and processing of carnallite ore are considerably more difficult and expensive for the following reasons:

- Carnallite ore has unfavorable mechanical properties that make mining more difficult.

- The  $K_2O$  content of pure carnallite is ca. 17%, compared with ca. 63% for pure sylvite.
- Whereas the separation and purification of sylvite from sylvinitic ore can usually be carried out by flotation, which does not involve a phase change, the extraction of potassium chloride from carnallite ore necessitates dissolution or decomposition of the carnallite, and a high energy consumption for decomposition or purification of the decomposition product, depending on the process.
- The treatment of carnallite generates large quantities of concentrated magnesium chloride solution, which must be disposed of.

For these reasons, mined carnallite ore is today seldom used as a raw material. However, carnallite is often a major component in mixed salts of the hard salt type, and hence influences the choice of processing method.

Large quantities of a carnallite halite mixture obtained by solar evaporation of water from the Dead Sea are used for the production of potassium chloride in Israel and Jordan.

**Theoretical Basis.** The theory of the production of potassium chloride from carnallite and carnallite-containing mixed salts is based on the  $KCl-MgCl_2-H_2O$  system shown in Figure 52.18, which is valid between -3 and 117 °C. In VAN'T HOFF coordinates (moles of salt per 1000 mol  $H_2O$ ) the points representing the composition of water ( $P_{H_2O}$ ), bischofite ( $P_{\text{bischofite}}$ ), and carnallite ( $P_{\text{carnallite}}$ ) are indicated. All possible mixtures of water and carnallite are shown on the straight line between  $P_{H_2O}$  and  $P_{\text{carnallite}}$ , the molar ratio  $K_2Cl_2:MgCl_2$  here being always 1:2, as in carnallite. The curve from  $L_4$  via R and E to point  $L_0$  represents an arbitrary isotherm, and indicates compositions in which solutions are in equilibrium with the corresponding solid phase. Point  $L_0$  gives the solubility of KCl in water, and the solutions  $L_1$  are in equilibrium with KCl as the solid phase. Solution E is in equilibrium with the solid phases KCl and carnallite, and the solutions  $L_2$  are in equilibrium with carnallite only. Solution R is in equilibrium with bischofite and

carnallite. The solutions  $L_3$  are in equilibrium with bischofite, and point  $L_4$  indicates the solubility of bischofite in water.

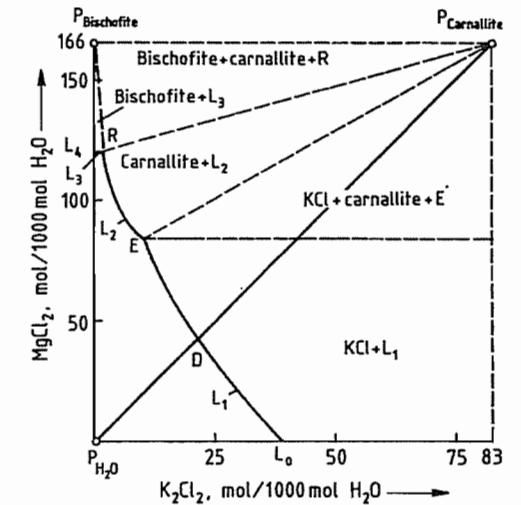

Figure 52.18: The system  $KCl-MgCl_2-H_2O$  (not to scale) represented by using van't Hoff coordinates.

If carnallite is dissolved in water, the composition of the solution follows the straight line  $P_{H_2O}-P_{\text{carnallite}}$ , which intersects curve  $L_1$  at point D. Here, the solution is saturated with KCl, and further addition of carnallite results in dissolution of  $MgCl_2$  and crystallization of KCl until point E is reached. This incongruent solubility is the basis for the simple method of processing carnallite (i.e., cold decomposition by mother liquor).

Carnallitic potash ores or crystallized products from solar evaporation always contain so much halite that solutions produced during processing are saturated with sodium chloride. Figure 52.19 is a section from the quaternary system  $KCl-NaCl-MgCl_2-H_2O$  saturated with NaCl, showing the 25 °C and 105 °C isotherms. The kieserite content in the ore in the region of the solutions E has in practice a negligible effect on the composition of the solutions. Some analyses of equilibrium solutions of the quaternary system are given in Table 6.

**Processing Methods.** Many processes for the treatment of carnallite have been described in the literature and used [88], but only a few are important today. By far the most important is

cold decomposition by mother liquor. The complete dissolution process is still used occasionally.

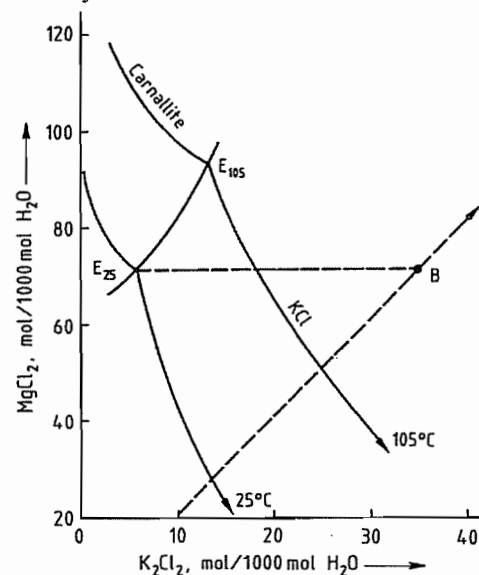

Figure 52.19: Quaternary system ( $K_2Cl_2$ - $MgCl_2$ - $Na_2Cl_2$ - $H_2O$ ) saturated with NaCl. See text for explanation.

Table 52.9: Composition of stable saturated solutions in Figure 52.19.

| Point <sup>a</sup> | Temperature, °C | Density, g/cm <sup>3</sup> | Concentration, mol/1000 mol H <sub>2</sub> O |                   |                   |                                 |
|--------------------|-----------------|----------------------------|--|-------------------|-------------------|---------------------------------|
|                    |                 |                            | K <sub>2</sub> Cl <sub>2</sub>               | MgCl <sub>2</sub> | MgSO <sub>4</sub> | Na <sub>2</sub> Cl <sub>2</sub> |
| E <sub>25</sub>    | 25              | 1.275                      | 5.8  | 70.8              |                   | 4.4                             |
| Q <sub>25</sub>    | 25              | 1.291                      | 5.8  | 68.0              | 5.2               | 4.2                             |
| E <sub>105</sub>   | 105             | 1.328                      | 13.2   | 93.7              |                   | 4.4                             |
| Q <sub>105</sub>   | 105             | 1.325                      | 13.7   | 92.9              | 1.0               | 4.3                             |

<sup>a</sup> Solutions Q<sub>25</sub> and Q<sub>105</sub> are saturated with MgSO<sub>4</sub> and NaCl, and correspond to solutions E<sub>25</sub> and E<sub>105</sub>, which are saturated with NaCl.

Cold decomposition is carried out at ambient temperature (e.g., 25 °C). Carnallite ore is mixed and agitated with water or with a solution of low MgCl<sub>2</sub> content such that the composition of the mixture corresponds to point B in Figure 52.19. This causes the crystallization of an amount of potassium chloride corresponding to the line B-E<sub>25</sub>, with formation of a solution of composition E<sub>25</sub>. The very fine potassium chloride produced still contains fine, salted-out sodium chloride, undissolved halite, and sometimes kieserite and clay, depending on the composition of the car-

nallite ore used. Approximately 85% of the potassium chloride contained in carnallite can be obtained as a crystalline product by this process. The yield can be increased by evaporative concentration of the decomposition mother liquor E<sub>25</sub> or Q<sub>25</sub> (analyses are given in Table 52.10). During evaporation, sodium chloride and sometimes magnesium sulfate crystallize and must be removed. The synthetic carnallite that crystallizes when the concentrated solution is cooled is fed to the cold decomposition process.

Table 52.10: Typical grain-size distribution in potash fertilizers (cumulative percentage retained).

| Mesh width, mm | Tyler mesh | Cumulative subsieve fraction |        |          |
|----------------|------------|------------------------------|--------|----------|
|                |            | Granular                     | Coarse | Standard |
| +3.36          | + 6        | 2-12                         |        |          |
| +2.38          | + 8        | 30-45                        | 2-20   |          |
| +1.68          | + 10       | 75-90                        | 25-50  |          |
| +1.19          | + 14       | 95-98                        | 70-90  | 5-15     |
| +0.84          | + 20       | 99                           | 90-98  | 20-45    |
| +0.60          | + 28       |                              | 99     | 50-75    |
| +0.42          | + 35       |                              |        | 70-90    |
| +0.30          | + 48       |                              |        | 85-95    |
| +0.21          | + 65       |                              |        | 96-98    |
| +0.15          | +100       |                              |        | 97-99    |

Potassium chloride from the decomposition, which consists of very finely divided particles and is rather impure, must be purified. Purification by flotation is difficult owing to the fineness of the decomposition product. For this reason, purification is nearly always carried out by the hot leaching process, which yields a very pure, completely water-soluble, coarse-grained product.

The mother liquor E<sub>25</sub> or Q<sub>25</sub> from the decomposition process can take up a certain amount of sodium chloride (see Table 52.10). If the carnallite used in the cold decomposition contains only small amounts of halite and if water is used for the decomposition, potassium chloride can be produced that requires no further purification, because sodium chloride has dissolved in the decomposition liquor. In Israel, a large proportion of the carnallite-halite mixture recovered from the Dead Sea by solar evaporation is so completely freed from halite by fractional crystallization and hydraulic classification that a grade of potassium

chloride with > 60% K<sub>2</sub>O can be produced directly by cold decomposition. This so-called cold crystallization process is carried out so that the crystals produced have the same grain size as those from the crystallization plant of

the hot leaching process and no further increase in grain size is required. A schematic diagram showing various processes used in the treatment of carnallite from the Dead Sea is given in Figure 52.20.

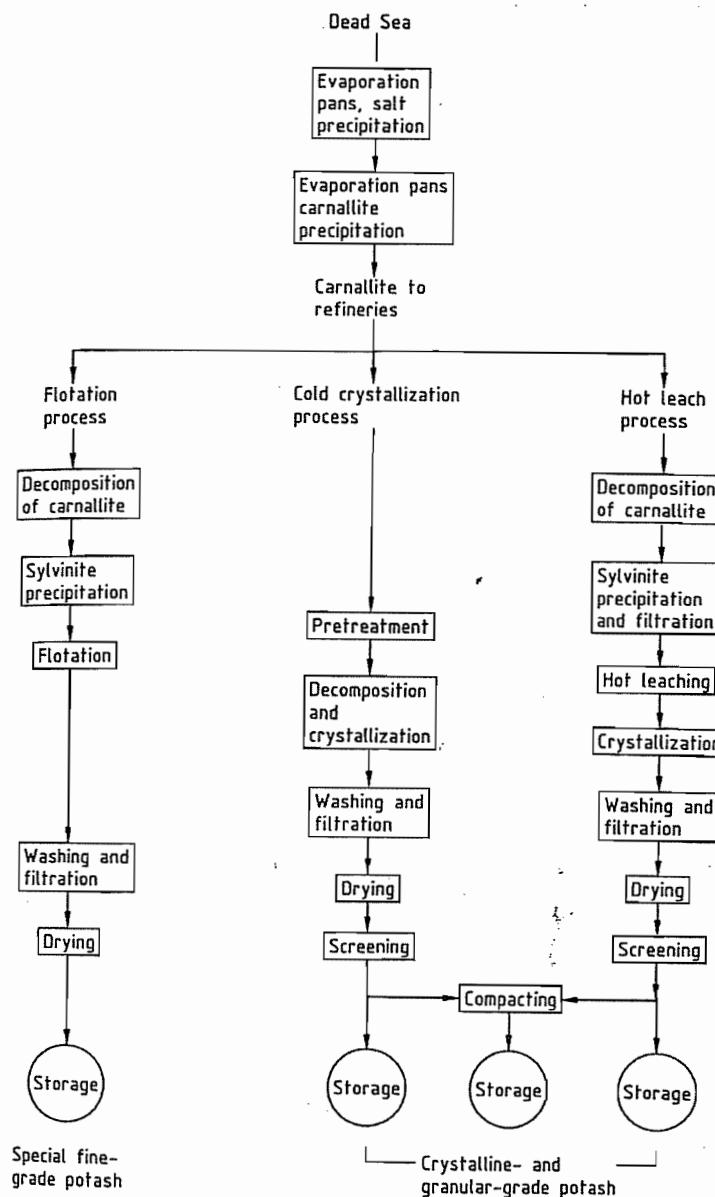

Figure 52.20: Flow diagram for potassium chloride production by the Dead Sea Works Ltd. (Israel) [82]. Reproduced from [82] with permission.

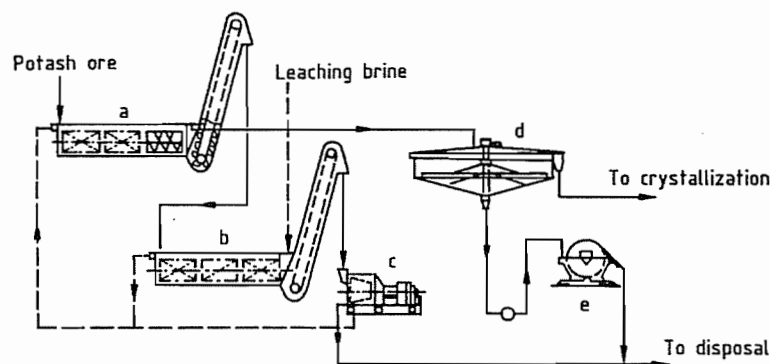

Figure 52.21: Leaching system with residue debrining: a, b) Screw leachers with draining elevators; c) Vibratory screen centrifuge; d) Hot clarifier; e) Rotary filter.

In the electrostatic treatment of carnallitic hard salts, concentrates can be produced that contain various amounts of halite together with sylvite and carnallite. These concentrates are reacted with suitable process brines or with water to bring about cold decomposition of the carnallite. The  $K_2O$  content of the product, and hence its potential use, depend on the halite content of the concentrate.

The complete dissolution process is used in an experimental plant in central Germany in which carnallite is extracted from a salt deposit by solution mining [126].

The crude salt is dissolved by a solution in which the magnesium chloride content is adjusted so that at the chosen temperature of ca. 80 °C, no decomposition of carnallite takes place, and hence no crystallization of potassium chloride, and the carnallite is completely dissolved. The solution, which is almost saturated with carnallite, is pumped out, evaporated, and cooled, causing crystallization of the carnallite, which is then treated by the cold decomposition process to produce potassium chloride.

For mixed salts containing less than ca. 15% carnallite, carnallite decomposition is generally dispersed with, and the ore is treated directly by the hot leaching process. The magnesium chloride that enters the process in the carnallite must be removed from the brine circuit in appropriate process brines. If the carnallite content of the ore is high, a carnallite

decomposition stage is carried out before the hot leaching process.

#### 52.11.2.4 Equipment

**Leaching.** The choice of leaching equipment depends on the properties of the material to be leached and the throughput required. The techniques used in plants in which the potash is completely leached (e.g., in many German and French plants) differ fundamentally from those in plants (e.g., in Canada) where only the fine materials from a screening operation, cyclone fines, and slimes are recrystallized or extracted.

Potash ores are leached at rates of up to 1000 t/h salt, producing up to 2000 m<sup>3</sup>/h solution. Screw dissolvers, up to 14 m long and 3 m in diameter, are widely used (Figure 52.21). High material transfer is achieved by fitting partitions in the upper part of the dissolver at intervals of 2–3 m. These are immersed in the suspension of crystals and force the solution to flow perpendicular to the main flow direction. At the outlet of the dissolver, the solids are scooped from the solid-liquid mixture by an elevator system with perforated buckets from which liquid drains during conveying; the residual water content is ca. 15–20%. Alternatively, bucket wheels can be used.

Elevators or bucket wheels remove only the coarse residue (ca. 75% of the total residue) from the screw dissolver. The amount of po-

tassium chloride-containing solution adhering to the coarse residue is usually lowered to 2–4% by centrifugation.

The fine residue (ca. 25% of the total residue), which consists of very fine salt and insoluble components of the ore (mostly anhydrite and clay), flows with the raw solution from the screw dissolver into the hot clarifier, where flocculation agents are added and sedimentation occurs. Sealed, insulated circular clarifiers are used. The fine residue is removed from the hot clarifier as a suspension with a solids content of ca. 50% and debrined on rotary filters to a residual water content of 10–16%. To avoid losses of potassium chloride, the solution adhering to the residue must be removed. For small quantities of residue, this is done by washing on the filter with water or a process brine having a low potassium chloride content. For large amounts of residue, two- or three-stage water washing is used; the filter cake is slurried with the water, and the resulting suspension is filtered. This treatment is repeated once or twice.

In North America, where the flotation process predominates and only small quantities of

ore are treated by the hot leaching process, a series of agitated vessels is used. The leaching process takes place in either cocurrent or countercurrent flow. Between the stages of countercurrent leaching, solid-liquid separation is carried out with hydrocyclones or hydroclassifiers [146]. The layout of a leaching plant including crystallization is shown in Figure 52.22.

**Crystallization** [147, 148]. The hot solution from the clarifier of the leaching plant is almost saturated with potassium chloride and is cooled by expansion evaporation in vacuum equipment to cause crystallization. The vapors are condensed in surface or barometric condensers, with process brines used for higher temperatures and cooling water for lower temperatures. The amount of heat that can be recovered depends on the number of stages in the cooling system. In the past, vacuum cooling plants were constructed with up to 24 stages, to give maximum possible heat recovery. However, the number of stages in a modern plant is usually between four and eight.

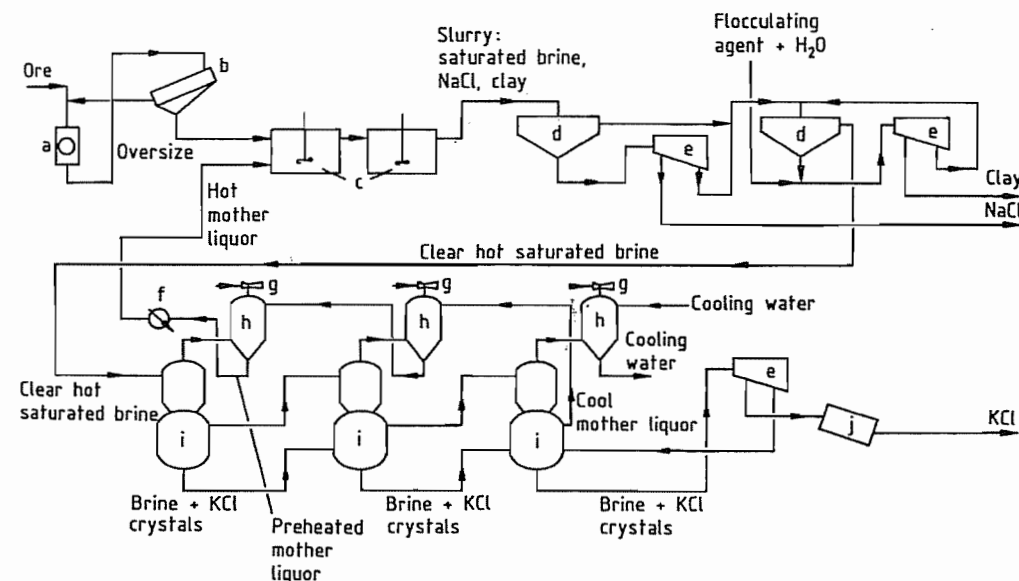

Figure 52.22: Leaching-crystallization process for production of potassium chloride from potash ore [86]. Reproduced from [86] with permission. a) Crusher; b) Screen; c) Leach tanks; d) Thickener; e) Centrifuge; f) Heater; g) Steam ejector; h) Barometric condenser; i) Vacuum cooler-crystallizer; j) Dryer.

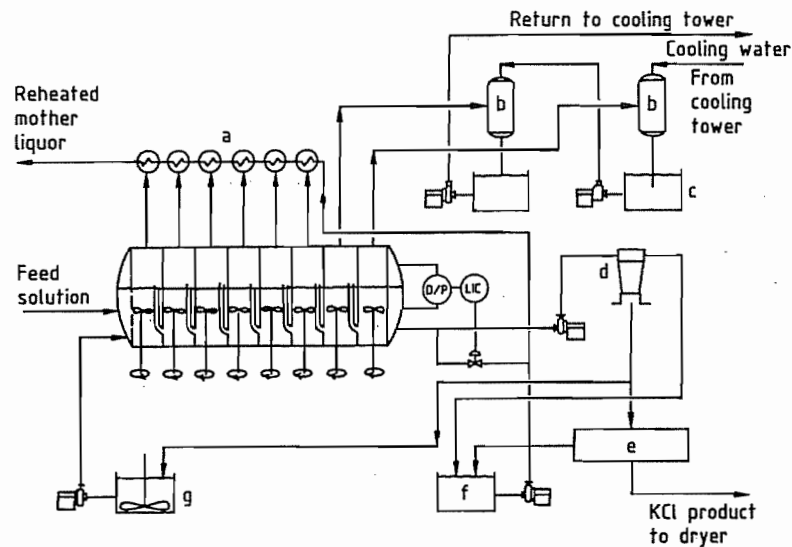

Figure 52.23: Eight-stage horizontal crystallizer: a) Surface condensers; b) Barometric condenser; c) Hot well; d) Cyclone; e) Centrifuge; f) Filtrate tank; g) Slurry holding tank. Reprinted with permission from E. M. McKercher et al., *Proc. 1st Int. Potash Technol. Conf.*, Oct. 3-5, 1983, Pergamon Press.

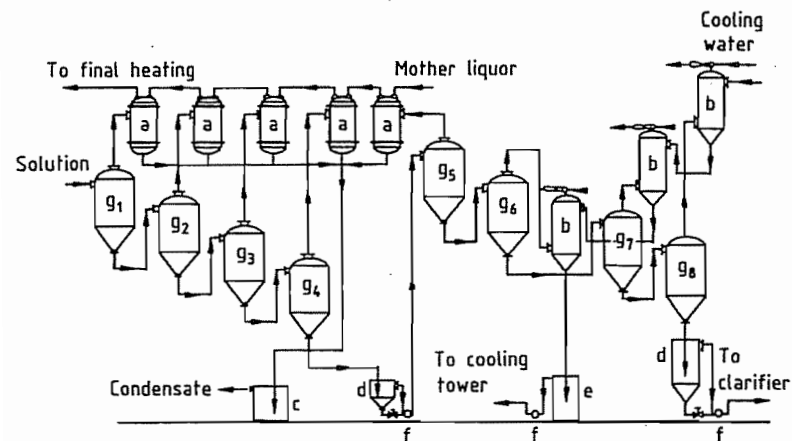

Figure 52.24: Conical-based evaporator-crystallizer plant with eight evaporation stages: a) Surface condensers; b) Barometric condensers; c) Barometric collection vessel for condensate; d) Barometric collection vessel for salts and brines; e) Barometric collection vessel for cooling water; f) Pumps; g<sub>1</sub>-g<sub>8</sub>) Evaporators.

The high cooling rate of a vacuum plant results in a high degree of supersaturation that produces very fine crystals, unless the design of the plant and the crystallizing conditions are optimized to give a coarse product. Several suitable crystallizers are now available.

If it is not important to have coarse crystals (e.g., if they are to be reprocessed), stirred crystallizers or conical-based evaporators are

used. The former consist of horizontal cylindrical vessels divided into chambers by vertical walls. The solution or suspension flows from chamber to chamber through openings in the walls as it is cooled. These crystallizers are provided with mechanical stirrers or air agitation (Figure 52.23).

The conical-based evaporator consists of a vertical cylinder with a lower conical section.

The solution is sprayed into the top, and much of the water evaporates. A certain liquid level is maintained in the evaporator, into which liquid from the nozzle falls as a supersaturated solution. Several evaporators are arranged in series one above the other so that the suspension flows through each stage in the direction of decreasing pressure without the need for intermediate pumps (Figure 52.24). The advantage of this arrangement lies in its very simple and economical construction, with no moving parts. However, the product is very finely divided.

The aim of the crystallization process is usually a dust-free product with optimum grain size. Two main requirements must be met to achieve this: the solution must have only a slight degree of supersaturation, and this should be removed by crystallization on seed crystals that are already present. The slight degree of supersaturation is achieved by providing internal circulation within each crystallization stage, in which the cooled solution is mixed with the added hot solution in an exactly controlled ratio. The continuous presence of seed crystals is ensured by keeping the solids content in each crystallizer at ca. 30%.

These conditions are fulfilled by two types of crystallizer: the fluidized-bed (Oslo) type and the draft-tube agitated type.

In the Oslo crystallizer (Figure 52.25), the solution is supersaturated in a separate evaporator and flows into a crystal slurry vessel below, where the supersaturation is removed by crystallization on KCl crystals already present. To reduce the degree of supersaturation in the evaporator, a large amount of clarified solution is pumped from the crystal slurry vessel into the evaporator, together with the incoming hot feed solution. Clarified solution for the next stage is removed from the vessel at another takeoff point. A crystal suspension is also removed from the vessel at a rate corresponding to the rate of crystallization, and is fed either to the next stage as seed crystals or to the debrining stage. Crystallizers of this type are constructed by companies such as Lurgi, Swenson, and Struther-Wells.

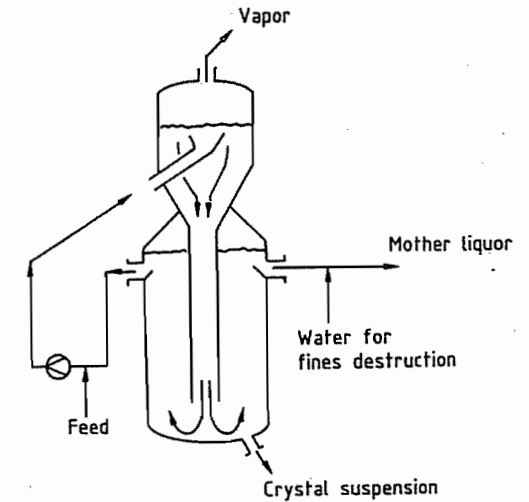

Figure 52.25: Oslo crystallizer.

In draft-tube agitated crystallizers, a state of supersaturation is created and removed in the same crystallizer. This type is manufactured by Swenson (DTB = draft tube baffle), Standard-Messo, and Kali und Salz. In the Swenson and Standard-Messo crystallizers, the entire suspension is brought into continuous contact with the evaporator surface by a propeller stirrer that provides internal circulation; immediately after supersaturation is achieved, a large quantity of salt is made available to remove the state of supersaturation. The coarser crystals collect preferentially in the lower part of the crystallizer, where they are removed as a suspension and fed to the next stage or to the debrining stage. The hot solution is passed through a clarifying zone and is fed to the next stage.

All the processes described so far are operated cocurrently (i.e., the crystallizing salt is transported with the cooling solution from one stage to the next). In contrast, the Kali und Salz process (Figure 52.26) operates countercurrently [149]. The salt produced in each crystallizer is passed through a classifier at the bottom of the crystallizer as soon as a predetermined minimum crystal size has been reached; then, unlike the other systems, it is passed to the next hottest stage. The classifier is fitted with equipment that enables the up-

ward flow rate, and hence crystal concentration and product crystal size, to be controlled independently of the throughput rate of the solution. Mixing of the cooler solution with the hotter solution in a crystallizer is prevented by transferring the salt with the help of the solution from the stage into which it is pumped.

### 52.11.3 Flotation

Since the early 1900s, ores of many different kinds have been processed by froth flotation.

Investigations into the flotation of potash ores began in the early 1930s in the United States and the Soviet Union [150, 151]. The first full-scale plant began production in 1935 in Carlsbad (New Mexico, United States) [152].

The first reports of investigations into the flotation of potassium salts in Germany appeared in 1939 [153]; the first full-scale plant began operating in 1953 [154, 155].

At present, most of the worldwide production of potash fertilizers is by flotation. This is the most widely used process in Canada, the United States, the CIS, and France. Small hot

leaching plants are often attached to the flotation plants for treating slimes and intermediate products. The flotation process is not widely used in Germany, where a combination of electrostatic treatment with the hot leaching process predominates.

#### 52.11.3.1 Potash Ores Suitable for Flotation

Various types of crude potash salts can be treated by flotation:

**Sylvinite ores** are mixtures of sylvite (KCl) and halite (NaCl) in varying ratios. They represent the majority of potash ores treated. The sylvinites of Canada, the United States, and the CIS also contain up to 8% clay components [156].

**Hard salts** contain kieserite ( $\text{MgSO}_4 \cdot \text{H}_2\text{O}$ ), as well as sylvite and halite, and sometimes also anhydrite ( $\text{CaSO}_4$ ).

**Mixed salts** consist of a mixture of sylvinite ore or hard salt with carnallite ( $\text{KCl} \cdot \text{MgCl}_2 \cdot 6\text{H}_2\text{O}$ )

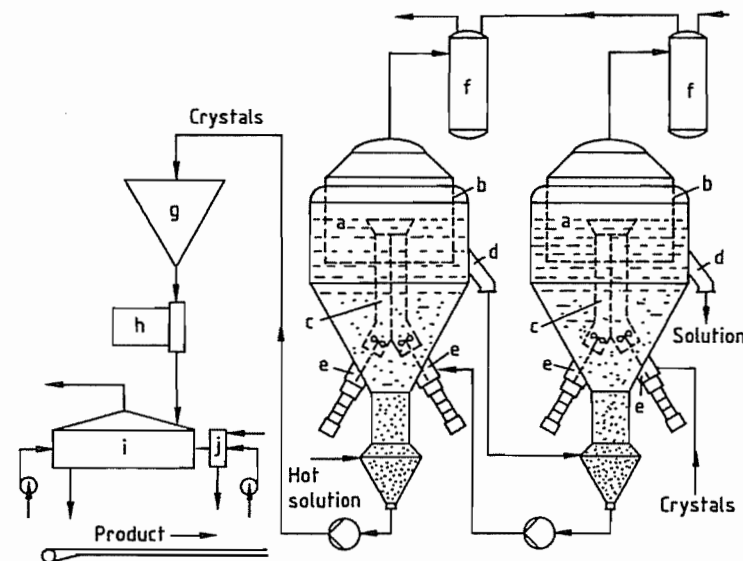

Figure 52.26: Kali und Salz countercurrent crystallization process: a) Crystallizers; b) Bells; c) Draft tubes; d) Liquor overflow; e) Stirrers; f) Condenser; g) Thickener; h) Centrifuge; i) Dryer; j) Combustion chamber.

**Polymneral salts** contain not only sylvite, halite, and kieserite, but also langbeinite ( $\text{K}_2\text{SO}_4 \cdot 2\text{MgSO}_4$ ), kainite ( $4\text{KCl} \cdot 4\text{MgSO}_4 \cdot 11\text{H}_2\text{O}$ ), polyhalite ( $\text{K}_2\text{SO}_4 \cdot \text{MgSO}_4 \cdot 2\text{CaSO}_4 \cdot 2\text{H}_2\text{O}$ ), and clay.

#### 52.11.3.2 Carrier Solutions

In the flotation of water-soluble salts the carrier liquids are salt solutions that are saturated with the components of the raw material.

Thus, sylvinite ore flotation is carried out in a KCl–NaCl solution. For the flotation of hard salt, the brine also contains various amounts of magnesium sulfate and magnesium chloride.

#### 52.11.3.3 Flotation Agents

The *collectors* are the true flotation agents, which selectively coat the surface of the component to be floated. For the flotation of sylvite, straight-chain primary aliphatic amines are used in the form of their hydrochlorides or acetates [157]. Mixtures of amines of various chain lengths, which largely eliminate the effects of pulp temperature variation, are extremely useful. A typical flotation amine has, for example, the following composition: 5%  $\text{C}_{14}\text{-NH}_3\text{Cl}$ , 30%  $\text{C}_{16}\text{-NH}_3\text{Cl}$ , 65%  $\text{C}_{18}\text{-NH}_3\text{Cl}$ , iodine number: 4.

*Foamers* contribute to the dispersion of long-chain amines and to the stabilization and homogeneous distribution of amine micelles [158]. The following substances are preferred: aliphatic alcohols with chain lengths  $> \text{C}_4$ , terpene alcohols, alkylpolyglycol ethers, and methyl isobutyl carbinol, which is used mainly in Canada and the United States.

*Extenders* for sylvite flotation are nonpolar materials, especially oils of various types. They are probably incorporated in the micelles and increase their hydrophobic properties. Extenders are especially effective in the flotation of coarse particles [159].

*Clay depressants* are used in salt flotation to block clay components, which would otherwise bind large amounts of flotation agent. Clay contents of 1.5–2% can be controlled by treatment with these depressants. If larger

amounts are present, additional steps must be taken (clay flotation or classification). Clay depressants include guar and starch products, carboxymethyl cellulose, and polyacrylamide [156].

#### 52.11.3.4 Theory

The combinations of reagents used for sylvite flotation have been found by empirical investigation.

Theoretical studies of the separation of potassium and sodium chloride by flotation have led to various interpretations.

The theories developed up to 1961 are thoroughly discussed in [160], which also describes experimental results that have contributed greatly to the understanding of salt flotation.

The most important theories are reviewed below:

According to the *exchange theory* [161–163], hydrophobic properties can be imparted to a mineral if the polar group of a collector can be incorporated into the crystal lattice in place of an ion. In the flotation of sylvinite ore, for example, exchange between the  $\text{K}^+$  ion (radius: 0.135 nm) and the  $\text{NH}_3^+$  group of the amine (radius: 0.143 nm) is assumed to occur, whereas the  $\text{Na}^+$  ion (radius: 0.095 nm) is too small (Figure 52.27). This does not account for the fact that kieserite ( $\text{MgSO}_4 \cdot \text{H}_2\text{O}$ ), for example, is readily floated by amines in water although the  $\text{Mg}^{2+}$  ion has a radius of only 0.065 nm.

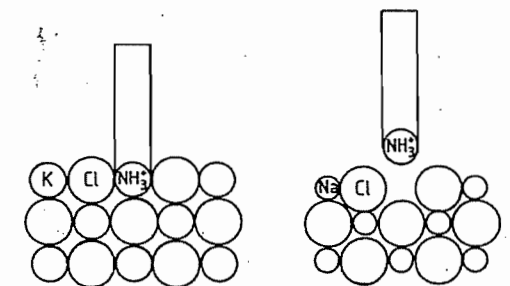

Figure 52.27: Incorporation of a polar group of the collector into the crystal lattice [161]. Reprinted with permission of the Society for Mining, Metallurgy, and Exploration, Inc.

The *structure theory* [164] postulates that the interanion distance in the crystal lattice of the salt matches the intermolecular distance in the lattice of the amine hydrochloride within  $\pm 20\%$ . In sylvite, this condition for oriented growth of the collector on the crystal is fulfilled, whereas the interionic distance of 0.398 nm in the halite lattice is too small. However, langbeinite has good flotation properties, although these steric requirements are not met [164].

According to the *hydration theory* [165], flotation of a mineral is impossible if it has a positive heat of solution, whereas salts with negative heats of solution can be floated. If heat is evolved when a salt dissolves, more energy is produced by hydration of the ions than is required for breakdown of the lattice. This suggests that such salts are strongly bonded to water molecules, preventing adhesion of the collector. A comment on this theory is given in [166].

Another hydration theory is based on new information on the hydration of ions in dilute solutions [167]. This differentiates between positive local hydration (in which the ion reduces the mobility of the neighboring water molecules) and negative local hydration (water molecules close to the ions are more mobile than in pure water).

According to [168], in the case of positive local hydration (e.g., with  $\text{Na}^+$  ions), the  $\text{Cl}^-$  ions are shielded by water molecules, so that the bond between a cationic amine and sodium chloride can only be weak. In the case of negative local hydration (e.g., with  $\text{K}^+$  ions), formation of a bond with the collector is unhindered. Application of these theories, developed for dilute electrolyte solutions, to the hydration state of salt surfaces is difficult, but should be qualitatively valid [168].

The G zone theory ( $G = \text{Grenzflächen} = \text{interfaces}$ ) [169] applies both to the flotation of sylvinites with amines and to the flotation of kieserite with an anionic surfactant (the sodium salt of a highly sulfated fatty acid). In both cases, adsorption of the collector proceeds by the same mechanism.

Amines and the anionic surfactant, in a saturated solution of salts that can be floated with these reagents, are present either as micelles or in true solution. In the usual carrier brines, flocculation (amines) or formation of very small droplets occurs (anionic surfactant).

Based on experimental results, zones are assumed to be formed on the surfaces of crystals suspended in a mixed-salt solution (carrier liquid) in which ions from the lattice are present in the form of a saturated solution.

When collectors are introduced into the suspension, they migrate to the zones where their solubility is greatest due to their thermodynamic tendency to dissolve (i.e., to the boundary zones of those particles that they cause to float). The bonding of the collectors in these zones is reinforced if their solubility in the surrounding carrier brine is low. The success of flotation depends on the strength of this bond (Figure 52.28).

Froth cannot be produced in the usual carrier liquids either by collectors or by foaming agents. The collision of an air bubble with a crystal coated with the collector material causes the latter to spread over the surface of the bubble, stabilizing it and causing the crystal to float.

Large-scale operations of sylvite and kieserite flotation has thus been placed on a good unified theoretical foundation.

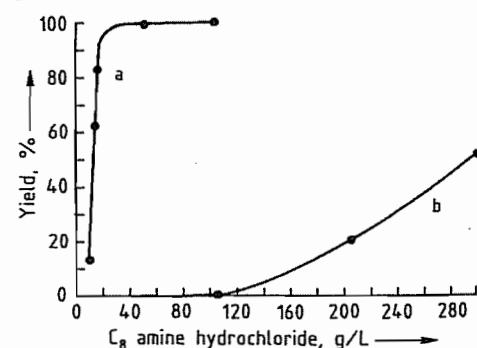

Figure 52.28: Flotation of potassium chloride with octylamine in saturated solutions of KCl and KCl + NaCl (Feed material: 20% KCl, 80% NaCl; 0.1–0.315 mm): a) Carrier liquid saturated in KCl and NaCl (low solubility of octylamine); b) Carrier liquid saturated only in KCl (high solubility of octylamine).

### 52.11.3.5 Flotation Equipment

The flotation equipment used in the potash industry resembles that used for flotation of other ores.

Mechanical flotation cells operate with a rotor stator system that causes both thorough mixing of the pulp and thorough distribution of the air, which can be drawn in by suction or injected from a compressed air network.

In recent decades, high-capacity flotation has been introduced almost everywhere. In this process, several stirrers operate in a single trough [170].

Agitair high-capacity flotation equipment is used in Germany, and the preconcentrate is purified in individual cells of the Denver type. Wemco high-capacity machines are used by the French potash industry, and Mechanobr high-capacity cells by the former Eastern-bloc countries.

Modified Mechanobr M 7 fluidized-bed units (Figure 52.29), manufactured by Mescerjakov, are standard equipment in the CIS [171, 172]. Typical features include the presence of a grid and circulation of the suspension via a box on the front wall of the cell, connected to the agitator by a circulation pipe.

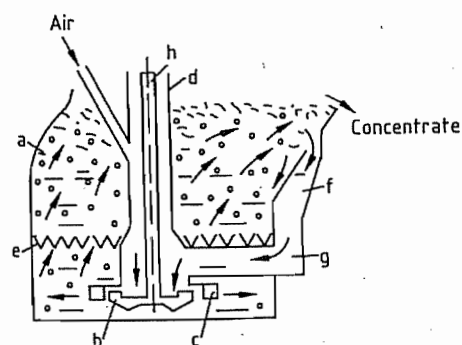

Figure 52.29: Mechanical flotation cell with fluidized bed: a) Flotation cell; b) Stirrer; c) Stator; d) Tube of the stirrer system; e) Grid; f) Circulation box; g) Circulation pipe; h) Shaft.

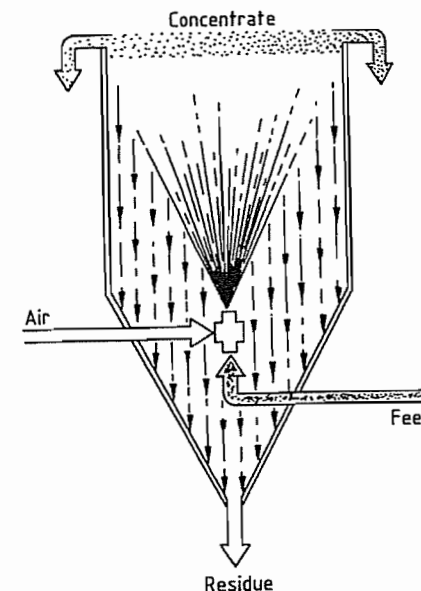

Figure 52.30: Principle of pneumatic free-jet flotation. Reproduced from [173] with permission.

Pneumatic flotation equipment operates without stirrers. In the free-jet flotation process developed in Germany [173], the conditioned pulp is pumped through an aerator fitted with a porous gas distributor or annular nozzle, either outside or inside the separation vessel, and flows as a free jet into the separation vessel. Air bubbles with the adhering minerals rise to the top and form a froth that flows over the edge of the vessel into a channel (Figure 52.30). The pneumatic flotation process has been tested successfully for a special case of sylvite flotation. It is used industrially for the recovery of kieserite from leaching residues.

In the CIS, a pneumatic flotation cell has been developed for the treatment of coarse sylvinites ores with a maximum grain size of 3–5 mm [174, 175] (Figure 52.31). The conditioned pulp is fed from above onto a layer of froth immediately above the perforated-tube aeration system. The hydrophobic sylvite crystals are retained in the froth, so that mechanical damage of the bubble-crystal combination is kept to a minimum. The flotation rate is very high.

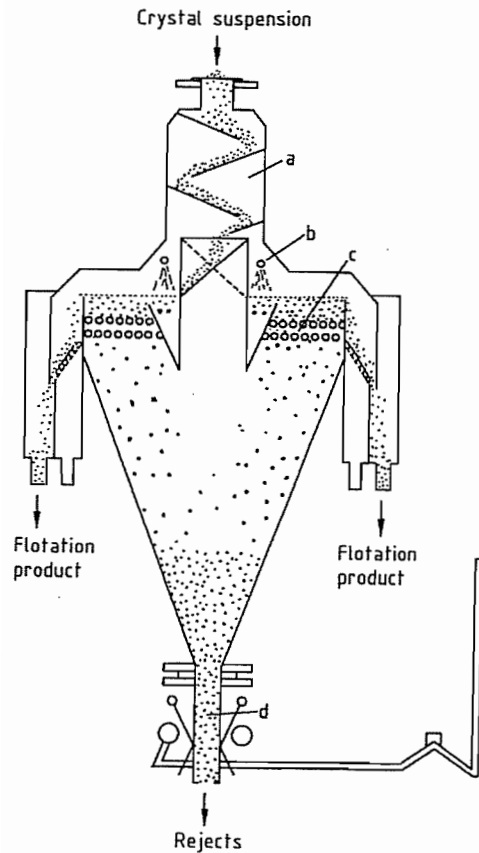

Figure 52.31: Pneumatic coarse-grain flotation cell (Gogorchimproect type) [174]. Reproduced from [174] with permission. a) Feeding device; b) Spray nozzle; c) Aeration system (perforated rubber tubes); d) Device for removing reject material.

### 52.11.3.6 Processes

**Sylvinite Ore Flotation.** Pure sylvinite of German origin can be floated without serious problems. The components of the ore are relatively strongly intergrown [128] and must be broken down by grinding until each grain consists as far as possible of only one component.

The ore is first ground to a particle size of < 4 mm, screened to remove fines, and then slurried with carrier brine and ground to a grain size of < 0.8–1.0 mm in a circulating system that includes rod mills, spiral classifiers, or wet screens (Figure 52.32).

The solids content of the flotation pulp is adjusted to 30–40%, and it is then mixed with flotation agents (ca. 40 g of oil, 20 g of foaming agent, and 40–80 g of collector per tonne of crude salt). As much of the desired product as possible is then extracted by the three-stage high-capacity rougher flotation. The rougher tails are classified in hydrocyclones, debrined (the coarse fraction in centrifuges, and the fine fraction in rotary filters), and dumped. Since the filtrate still contains finely divided salt, it is clarified in a thickener and recycled for slurrying the ore.

The material floated in the rougher flotation is then concentrated in a cleaner flotation process, usually in three stages. This does not produce a marketable product (with > 60%  $K_2O$ ). The concentrate is therefore separated from the brine and washed with water in salt washing equipment.

This washing process dissolves more halite than sylvite, producing a potash salt that meets quality requirements. The washing liquor is removed by centrifuges, and the product is dried and conveyed to silos.

The cleaner flotation process also produces some intermediate-quality product with a fairly high  $K_2O$  content, whose coarse particles contain most of the residual intergrown material from the ore. They are therefore recovered by hydrocyclones and fed to the screening-grinding stage for size reduction. The energy consumption for the entire process is ca. 10 kWh/t ore.

The treatment of sylvinite ores from Canada, the United States, and the CIS is more difficult owing to the clay content of up to 8%. The clay components disintegrate in the brine, forming very fine slimes that absorb large quantities of flotation agent. The flotation process is therefore sometimes preceded by a desliming stage (Figure 52.33). The clay is first detached from the surface of the salt by vigorous agitation in scrubbers, so that it can be floated in a separate operation. The clay is usually removed by multistage classification [176]. The fine material is then thickened and washed with water to reduce losses of  $K_2O$ .

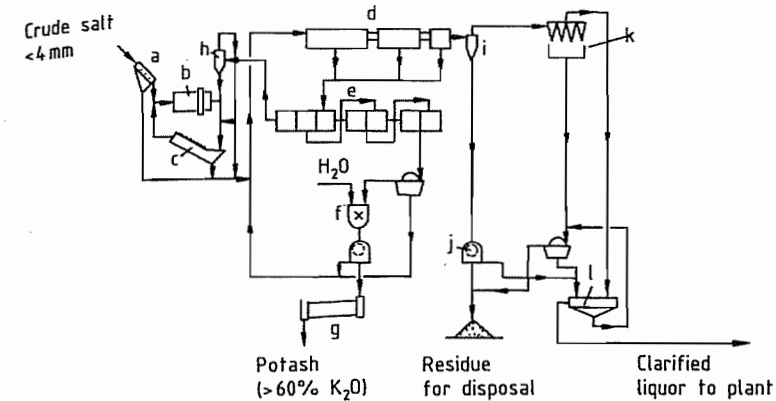

Figure 52.32: Flow diagram of the flotation of potash ores: a) Fine screen; b) Wet grinding; c) Classification; d) Rougher flotation (high volume); e) Cleaner flotation (three stage); f) Water washing for concentrate and debrining; g) Drying; h) Classification of intermediate-quality product; i) Residue (tails) collection; j) Residue debrining; k) Cyclone; l) Clarification of brine for recirculation.

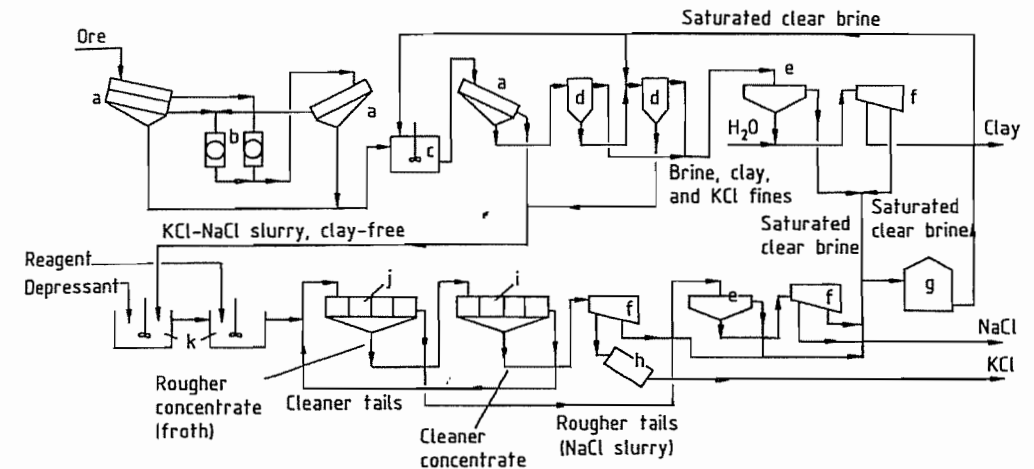

Figure 52.33: Schematic of flotation of potash ores: a) Screen; b) Crushers; c) Scrubber; d) Classifier; e) Thickener; f) Centrifuge; g) Brine tank; h) Dryer; i) Cleaner flotation cells; j) Rougher flotation cells; k) Conditioners. Reproduced from [176] with permission.

Up to 1.5–2% of residual clay in the crude salt can be handled by adding clay depressants.

An advantage of clay-bearing sylvinite ores is that they are usually sufficiently liberated at grain sizes of < 3–5 mm. Sometimes, coarse crystals are floated separately from fine crystals.

**Hard-salt flotation** is similar to the sylvinite flotation process (Figure 52.32). However, the flotation product also contains kieserite,

which cannot be removed by washing because it dissolves only slowly in water.

Sylvite, which is intergrown with kieserite, must therefore be liberated as fully as possible, which leads to increased grinding costs. Because of the increased production of fines, more flotation agent is needed. Also, in warm summer months, potassium-containing double salts (leonite, schönite) can separate from the circulating brine. Since these salts end up in the residue, the yield is reduced.

**Mixed-Salt Flotation.** Carnallite ( $\text{KCl} \cdot \text{MgCl}_2 \cdot 6\text{H}_2\text{O}$ ) in the mixed salt is usually decomposed by a brine with low  $\text{MgCl}_2$  content. The potassium chloride produced has a grain size of  $< 0.04$  mm and is accompanied by sylvinite ore or hard salt components.

In the 1980s, this complex salt mixture was successfully treated by flotation alone for the first time [177, 178].

Potassium chloride produced by the decomposition is first floated with a fairly small amount of amine in pneumatic or stirred flotation cells; then the sylvite component of the sylvinite ore or hard salt is floated with a further measured amount of amine, and a discardable residue is obtained. The flotation froth is then treated by flotation in cleaner cells to give a concentrate with  $> 55\%$   $\text{K}_2\text{O}$ . A final washing process gives a potash fertilizer salt containing  $> 60\%$   $\text{K}_2\text{O}$ .

**Polymineral salts** are rarely treated by flotation. Potash ore from Stebnik (CIS) contains not only sylvite, halite, and clay materials, but also large amounts of kainite, langbeinite, and polyhalite [179]. Clay depressants are added first, followed by flotation of halite with a mixture of  $\text{C}_7$ – $\text{C}_9$  fatty acids. Sodium hydroxide solution is used to adjust pH [179].

Schönite can be floated from a salt mixture by using coconut oil acids as the collector [180]. The flotation of anhydrite to produce a salt mixture of kieserite, langbeinite, and polyhalite is recommended in [181].

A combination of cold leaching and flotation for the treatment of salt mixtures containing langbeinite and polyhalite is described in [182].

#### 52.11.4 Electrostatic Separation

Electrostatic separation depends on the directional movement of electrically charged bodies or particles in an electric field. The processes used differ according to the various methods of producing or separating the charges and according to the separation equipment used. The separation of mixtures of salt minerals (e.g., in the treatment of crude potash ores) invariably involves the selective ex-

change of electric charges that takes place on contact between the various mineral particles, followed by separation in free-fall separators. Although roll separators are widely used for treating other minerals, they have not been used for salts, mainly because of their low throughput.

The first investigations into the industrial-scale separation of potassium chloride and sodium chloride were carried out after World War II by the International Minerals & Chemical Corp. in Carlsbad, New Mexico [183]. The ore, which contains alkali-metal chlorides and various amounts of clay and sulfate minerals, was ground, heated to ca.  $500^\circ\text{C}$ , cooled to ca.  $110^\circ\text{C}$ , and separated in a free-fall separator with a field strength of 2–6 kV/cm. Results were not encouraging and the method was abandoned.

Research in the Kaliforschungs-Institut in Hannover in 1956 led to an industrial breakthrough. The addition of organic and inorganic reagents much improved the electrical charge exchange between the mineral components, and the separating temperature could be reduced to  $< 100^\circ\text{C}$  [184, 185]. The potash works of Neuhof-Ellers, a subsidiary of Kali und Salz, was the first industrial plant to use this process to produce kieserite in 1974. In the following years, plants for the electrostatic production of kieserite and potash concentrates, and for the dry removal of residues, were installed in three other factories, with capacities up to ca. 1000 t/h [186]. Investigations aimed at the introduction of this process for processing sylvinite ores from the potash deposits in Saskatchewan, Canada, have been carried out by PCS Mining, Saskatoon [187].

##### 52.11.4.1 Theoretical Basis

The basis of the process is the mutual selective exchange of electrical charge between the salt components, which occurs on contact. The direction, selectivity, and intensity of the charge exchange can be influenced by a large number of reagents (conditioning agents) [188]. In addition to this chemical conditioning, treatment with air of specific relative hu-

midity is necessary. This is usually controlled by means of the air temperature and should be between 5 and 25% [188, 189]. By the appropriate choice of conditioning agent and relative humidity, the charging properties of the individual mineral components in a potash ore can be controlled so that the desired components are recovered. In this way, an ore of complex composition can be completely separated into its components [190].

The mechanism of charging by contact depends on the transfer of electrons between the touching mineral surfaces, which must have suitable surface properties (i.e., surface energies appropriate for the exchange of charge). These energies are influenced (or created) by chemical conditioning agents and partial water vapor pressure [191–193].

##### 52.11.4.2 Equipment and Processes

Before the separation process, the potash ore must be size-reduced to give complete liberation of its components. Fine particles ( $< 0.1$  mm) behave nonselectively in an electrostatic field, so the grinding process must be carried out as carefully as possible (e.g., by impact grinding). The conditioning agents (20–100 g/t ore) are added to the ore in a mixer or introduced in the vapor state into the fluidized-bed dryer that heats the salt to the separation temperature ( $25$ – $80^\circ\text{C}$ ), whereby the relative humidity is adjusted to a suitable value for selective charging of the salt particles [194–196]. Alternatively, a rotary dryer can be used. Depending on the conditioning agent used and the relative humidity and temperature, sylvite generally becomes positively charged, whereas halite and kieserite can be positive or negative. Accompanying minerals such as langbeinite, carnallite, or kainite can be separated individually or together with other mineral components [197–200].

Separation of the mixture of charged minerals is carried out in free-fall separators with an electrical field strength of 4–5 kV/cm. For a distance between the electrodes of 25 cm, the applied voltage is 100–125 kV. Formerly, ver-

tical belt separators were common, but they are now used only for special applications. The electrodes consist of rotating rubber belts with conducting coatings. Brushes on the side opposite the electric field remove salt fines, which otherwise settle on the electrode surface, forming a coating that weakens the electric field and hinders separation. The separator used exclusively today is the tube free-fall separator (Figure 52.34), which was developed by the potash industry [201]. It consists of two opposed rows of steel tubes, ca. 2 m long. The tubes rotate on their axes, and salt fines are removed by brushes on the side remote from the falling salt. The maximum working length of separators of this type is ca. 10 m. The charged salt mixture leaving the fluidized bed is fed to the top of the separator and falls through the electric field between the electrodes. This causes the particles to move sideways, the direction depending on the sign of the charge. At the bottom of the separator, adjustable flaps enable a cathodic fraction, an anodic fraction, and a middle fraction to be recovered. These fractions are then treated further or removed from the process as product and waste (or middlings).

With currently available separator designs and achievable electric fields, the particle sizes for complete liberation should not exceed 1.5–2 mm for sylvite and halite, or 1.2 mm for kieserite, because the movement of particles in the electric field of the separator is determined by both the horizontal electrical force and the vertical effect of gravity. Since the electrical force depends on the charge on the particle, which in turn is a function of the surface area, the surface volume ratio is a very important factor in determining the extent of sideways movement in the electric field. For fine materials, the effect of the electrical force is the greater; the converse is true for coarse particles.

Modern tube free-fall separators have a throughput of 20–30  $\text{th}^{-1}\text{m}^{-1}$ . Their energy consumption is very low because for this throughput the current is only ca. 2 mA.



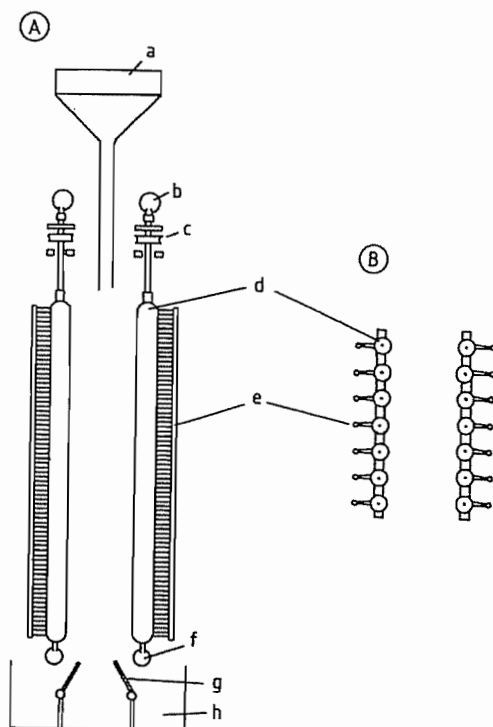

Figure 52.34: Tubular free-fall separator. A) Cross section; B) Plan view. a) Salt feed; b) Upper bearing; c) Motor; d) Tubes; e) Brushes; f) Lower bearing; g) Flaps; h) Receiver for products.

Generally, even for a single-stage separation step two free-fall separators are arranged one above the other so that the concentrate and waste material from the upper separator bypass the lower one, while the middlings flow directly to the lower separator where further separation occurs. In most cases, multistage separation or treatment is necessary, in which the concentrate produced in the first stage is purified or concentrated in another single stage or in multistage separation.

Electrostatic separation has thus far been used industrially on a large scale only for the treatment of hard salts with the principal components sylvite, halite, kieserite, and various percentages of carnallite. Three basic methods of separation into the individual components are

1. Separation of sylvite in the first stage [183, 189, 202], and separation of kieserite and halite in the second stage
2. Separation of kieserite in the first stage [203, 204], and separation of sylvite and halite in the second stage
3. Separation of halite in the first stage [205–207], and separation of kieserite and sylvite in the second stage

In all cases, carnallite appears in the sylvite fraction.

The first stage of method 2 is used to produce kieserite on a large scale, and method 3 is used in several variations for the production of a dry halite residue and of kieserite and potash concentrates [186]. So far, these plants have been operated almost entirely in association with leaching and flotation plants because electrostatic treatment alone gives unsatisfactory yields.

### 52.11.5 Heavy-Media Separation

Heavy-media separation is not used widely in the potash industry because of the generally unfavorable extent of intergrowth and the small density difference between the main components sylvite ( $\rho = 1.99$ ) and halite ( $\rho = 2.17$ ). However, the process can be used for very coarsely intergrown high-quality sylvite ores as mined in Saskatchewan. International Minerals & Chemical Corporation (IMCC) operates a plant of this type in Esterhazy, Saskatchewan [208]. The heavy medium is a suspension of magnetite in a saturated salt solution whose density is adjusted to 2.10. Small salt crystals ( $< 1.7$  mm) are very difficult to separate from magnetite; therefore, only materials with a particle size of 1.7–8 mm are treated by this process. Separation is carried out in hydrocyclones in two stages. A process scheme is given in Figure 52.35.

IMCC also operates a heavy-media separation plant in Carlsbad, New Mexico, where langbeinite ( $\rho = 2.83$ ) is recovered from a potash ore in which sylvite and halite are the other main components.

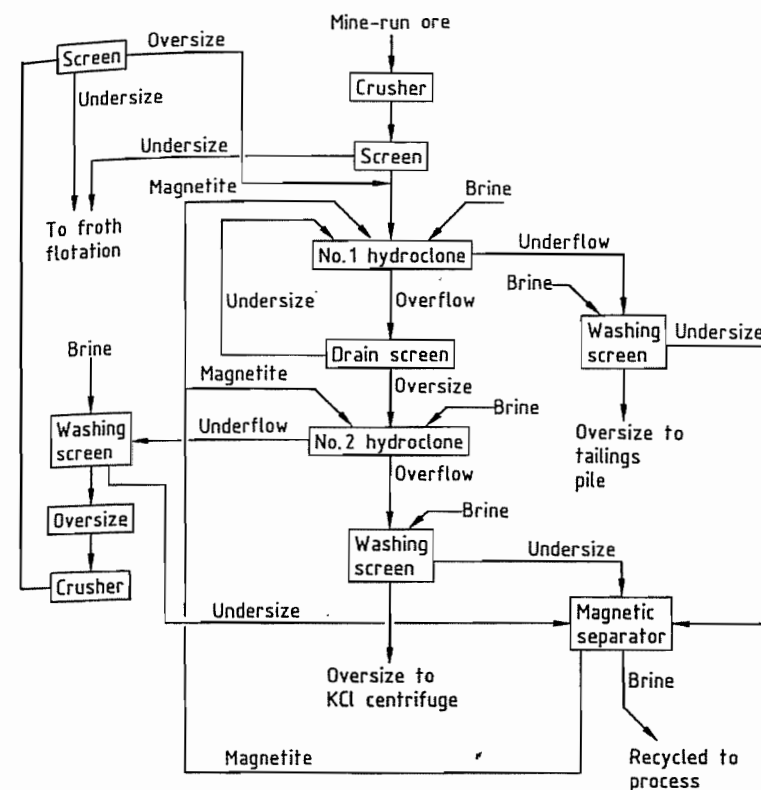

Figure 52.35: Heavy-media separation of potash ore [208]. Reprinted from [208] with permission of John Wiley & Sons, Inc.

### 52.11.6 Debrining and Drying

The products and waste from all the treatment processes except for the dry electrostatic process are obtained as suspensions with various solids contents and must be debrined. The two main aims of debrining potassium chloride product are (1) to achieve as low a moisture content as possible to minimize drying costs and (2) to remove as much of the adhering brine as possible to maximize product purity. As the brine adhering to the residues contains potassium chloride, its recovery minimizes yield losses. Suspensions must often be thickened in circular thickeners or hydrocyclones before debrining.

The choice of equipment is determined mainly by the particle size of the material to be treated. The extent to which adhering brine

can be removed by washing with water is also important.

Pan filters are used where debrining of a fine-grained product is combined with water washing to increase the  $K_2O$  content and when the product is to be stored intermediately. Residual moisture content in this case is 12–14%.

Drum filters are generally used for debrining fine residues or when washing of the filter cake is necessary; they give a residual moisture content of 9–11%. Alternatively, belt filters are used because they have a high capacity and allow the filter cake to be washed with recovery of the washing liquids.

The most commonly used debrining apparatus consists of centrifuges of various designs [209]. In potash works in Canada, the United States, Jordan, and the CIS, screen-bowl and

solid-bowl centrifuges of 1400-mm diameter are in general use. Screen-bowl centrifuges have throughputs of 60–110 t/h and achieve a residual moisture content of 3–8%. They are used to treat both products and residues. Solid-bowl centrifuges mostly are used for fine residues, and achieve throughputs of 70–120 t/h and a residual moisture content of 6–8%. In European and some Canadian factories, large-diameter (> 900 mm) pusher centrifuges are used, with throughputs of 40–50 t/h and a residual moisture content of 3–6%. For coarse products and residues, vibratory screen and screw screen centrifuges are generally used. These have a diameter of 900–1200 mm and a throughput of 35–70 t/h, and give a residual moisture content of 2–4%.

The products are usually dried in drum dryers with diameters up to 3 m and lengths of 20 m [210]. They are heated with oil or gas in cocurrent flow at throughputs up to 120 t/h. The dryers are fitted with internals to promote heat exchange and prevent caking of the salt. Exhaust gases are dedusted, first by cyclones and then by electrostatic filters, wet scrubbers, or fabric filters. The main reasons for the widespread use of drum dryers are their ruggedness, safe operation, lack of sensitivity to throughput variations, and adaptability to differing grain sizes and moisture content.

Since the early 1960s, fluidized-bed dryers have been used to an increasing extent. At first, they were used mainly for coarse products (> 0.5 mm) with low initial moisture content. Later, improvements in fluidized-bed technology enabled products with grain size down to 0.1 mm and initial moisture content up to 8% to be dried. Their most important advantages compared with drum dryers are improved heat and mass transfer, more efficient use of energy, and much smaller floor space requirement. Cyclones and bag or electrostatic filters are used for dedusting the exhaust gases from a fluidized-bed dryer.

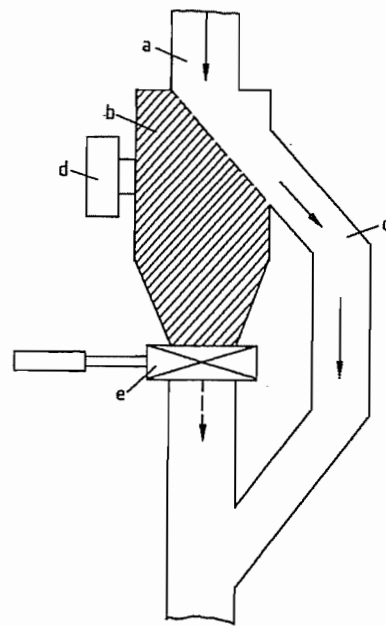

Figure 52.36: Equipment for radiometric determination of potassium in solid materials: a) Inlet for material to be analyzed; b) Container for material to be analyzed; c) By-pass; d) Detector; e) Time-controlled valve.

### 52.11.7 Process Measurement and Control

The methods normally used in the chemical industry for measuring and controlling process parameters are also used in potash plants. Special methods include the analytical determination of potassium by means of its natural radioactivity [211], the use of flame photometry for so-called ratio analysis, and mineral analysis by infrared spectrometry.

The natural mixture of potassium isotopes includes ca. 0.012% of the radioactive isotope  $^{40}\text{K}$ , which is both a  $\beta$  and a  $\gamma$  emitter. Both types of radiation are measured to determine potassium content. The  $\beta$  emissions are usually measured in the laboratory, whereas on-line measurement of  $\gamma$  emissions is widely used for process control. Owing to the great penetrating power of  $\gamma$  rays, the reliability of measurement is strongly dependent on the geometry of the measuring equipment. Equipment for the radiometric determination of

potassium in bulk products is shown in Figure 52.36 [212].

The on-line method of ratio analysis [213, 214] of KCl–NaCl mixtures is based on measuring the potassium and sodium contents of a sample with a double-beam flame photometer, and calculating the ratio from the measured data. Since this ratio is independent of the weight and dilution of the sample wet materials with varying water content can be analyzed without weighing the sample. Ratio analysis is used for determining residual NaCl content in flotation concentrates that have been water washed. The NaCl content is used to determine the amount of washing water required, and enables losses of  $\text{K}_2\text{O}$  due to excessive use of washing water to be avoided. The method has also been used for controlling the  $\text{K}_2\text{O}$  content in products from leaching–crystallization plants.

Infrared spectroscopy is suitable for continuous determination of carnallite or kieserite in crude potash salts. Reflection photometry can be used to measure water of crystallization, and hence the content of these minerals. In some circumstances, the carnallite content can be determined even when kieserite is present [214].

### 52.11.8 Waste Disposal and Environmental Aspects [215, 216]

The main environmental problem of the potash industry is disposal of process waste. The total world production of potash ore is ca.  $250 \times 10^6$  t/a, whose processing necessitates the disposal of ca.  $200 \times 10^6$  t of waste without damage to the environment [215]. In the Canadian province of Saskatchewan alone,  $300 \times 10^6$  t of solid waste has been generated during the last 30 years, covering an area of ca. 35  $\text{km}^2$  with solid and liquid materials [217].

The composition of the waste depends on the type of ore treated. Waste from the treatment of sylvinites consists mainly of halite. Waste materials from hard salt treatment are halite and kieserite, and from carnallite ore processing, halite and magnesium chloride, which is always produced in the form of an

aqueous solution. Salt solutions that must be disposed of are also generated during the production of potassium sulfate from potassium chloride and magnesium sulfate, and during the recovery of kieserite from residues from the treatment of hard salt by dissolving the halite.

Four methods for disposing of waste are dumping, backfilling, pumping into the ground, and discharge into natural water systems.

The disposal of waste by dumping is by far the most important method. Salt solutions that run off the dumped materials must be demonstrated not to harm the environment when they are absorbed into the ground. Salt solutions can originate from the brine adhering to wet residues or from the carrier liquid for transporting solid waste to the dump, or they can form when atmospheric precipitation dissolves the salt from waste material. If the ground underneath the dump is not impermeable, it must be sealed by layers of clay or plastic sheeting, or a combination of the two. The salt-containing runoff water is collected in ditches at the edges of the dump, and as much as possible is returned to the recirculating brine system in the plant. Excess brine is disposed of along with other liquid waste. In Germany, solid waste is formed into steep conical heaps after drying or debrining as fully as possible. This reduces the amount of salt-containing runoff water formed by atmospheric precipitation and also minimizes the ground area required. In most Canadian installations, filtration residues (tails) are slurried with brines and pumped as a suspension into a large lagoon surrounded by dykes. Flat deposits are formed over a very large area. The brine that runs off is pumped back to the plant and reused for slurrying solid waste (Figure 52.37) [218, 219]. If the salt solution enters groundwater-bearing layers despite sealing, boreholes are sunk, and salt-bearing groundwater is pumped back into the lagoon. Attempts to cover dumped waste material to prevent the formation of salt-containing water by the leaching effect of rainfall have in the long run proved unsuccessful [217].

Under certain geological conditions, and if mining methods are suitable, solid residues can be transported underground for backfilling. Since the bulk density of the residue is much lower than that of the potash ore, often only a part of the residue can be accommodated by the space left after extraction of the ore. Backfilling is the main method of waste disposal in North German salt works where the salt beds are steeply inclined, as well as the potash works of New Brunswick in Canada. In most potash works, where the potash is mined from level deposits, backfilling is not possible for technical and economic reasons.

Pumping salt solutions back into the ground is possible if certain geological requirements are met. The formation used for this purpose must possess sufficient porosity and permeability, and must have no contact with formations that could provide a water supply or contain salt deposits. Salt solutions are generally pumped under pressure through lined boreholes into the porous formation.

Since 1926, in the Werra potash region of Germany, large quantities of brine have been pumped into a porous dolomite layer 20–25 m thick. Injection wells have an absorption ca-

capacity up to 1000 m<sup>3</sup>/h at head pressures up to 11 bar [220]. Since most of this waste brine comes from kieserite production, the amount produced has decreased drastically with the introduction of electrostatic ore treatment [221]. In Saskatchewan, excess brine is pumped into deep formations of dolomite or sandstone. The capacity of these wells is up to ca. 200 m<sup>3</sup>/h at head pressures up to 60 bar. Kalium Chemicals, Saskatchewan, has been disposing of waste brine since 1979 in caverns produced by solution mining.

The possibility of disposing waste brine in rivers and lakes depends very much on the location. Sea disposal, as practiced in the United Kingdom and by one of the potash works in New Brunswick, presents few major problems if the outfall is sufficiently remote from the coast. The potash works on the Dead Sea can dispose of waste brine in the Dead Sea itself without harmful consequences. The Potash Company of America in Saskatchewan discharges its solid and dissolved wastes into the southern end of the salt-containing Lake Patience, which is isolated from the rest of the lake by a dam.

For most potash works, waste brine cannot be disposed in natural salt water. If underground disposal is impossible, disposal into flowing natural water is the only alternative. In all countries, this is subject to ever-stricter regulation. One particular problem, for which a solution in the foreseeable future is being sought, is the high salt content in the Werra River due to brine from the potash works in the eastern part of the Werra region [221].

The only significant atmospheric pollution caused by potash works is salt dust emitted by the drying plant and from the handling of the ore and products during production and supply. Dust removal from waste gases from dryers is discussed in Section 52.11.6. The dusts produced during production and conveying are usually removed by air extraction, and trapped in fabric filters or wet scrubbers. During the drying of products containing magnesium chloride brines, hydrolysis of the magnesium chloride can lead to the emission of hydrogen chloride, which can be removed from the gas by wet scrubbing or absorption in calcium hydroxide in combination with a woven filter [222]. This procedure can also greatly reduce the level of sulfur dioxide if it is present in the exhaust gas.

### 52.11.9 Granulation [223–227]

Potassium chloride can be produced in a wide range of crystal sizes, depending on the composition of the potash ore, its degree of intergrowth, and the process used. Different particle-size distributions are needed for various applications. To meet these requirements, the potash industry offers products with standardized size distributions (see Section 52.11.10) obtained by screening to give the various fractions. The resultant distribution of the product among the various standardized grades does not always correspond to market requirements. Demand for products with a particle size of ca. 1–5 mm (coarse and granular grades) exceeds their normal production rate in a potash works. Most potash works must therefore increase the proportion of coarse

product by granulating part of the primary product.

The main reason for the high demand for granulated potassium chloride is the technique of applying fertilizers that was developed mainly in North America and Western Europe in the postwar years. This technique, which is now the most widely used, requires coarse particles with a rather narrow size range. This is needed both for single nutrient fertilizers and for bulk-blended materials, which are widely used in North America. Also, granulated potassium chloride has a lower tendency to cake or form dust than the fine product.

Two methods of granulation are commonly used in the fertilizer industry: agglomeration of molten or wet material in rotating drums or dishes, or compaction of dry material in roll presses. The latter is the method most often used for potash fertilizers.

The starting material for compaction usually consists of a mixture of fine material from the production process with recycled material from the grinding and screening system of the compaction plant. Although dusts from the plant can also be compacted, a high proportion of fines (< 0.1 mm) must be avoided because they cause problems in the compaction equipment. Amines from the flotation process on the surfaces of the particles can also interfere with compaction and must be destroyed or rendered inactive by heat or chemical treatment.

Roll presses used in the potash industry usually have 60–125-cm-long rolls with diameters of 60–100 cm. The feed material, which is usually at 100–120 °C, is generally predensified by force feeders that feed it into the nip between rolls, where it is deaerated and compressed, with plastic deformation of each particle, to produce a dense sheet of material. The compression force is 40–50 kN/cm of roller length. The sheet of material is fed to a pre-breaker that size-reduces it for ease of transportation. It then goes to a grinding sieving plant, which produces either a granular product or granular and coarse products. Undersize material is recycled to the compaction press.

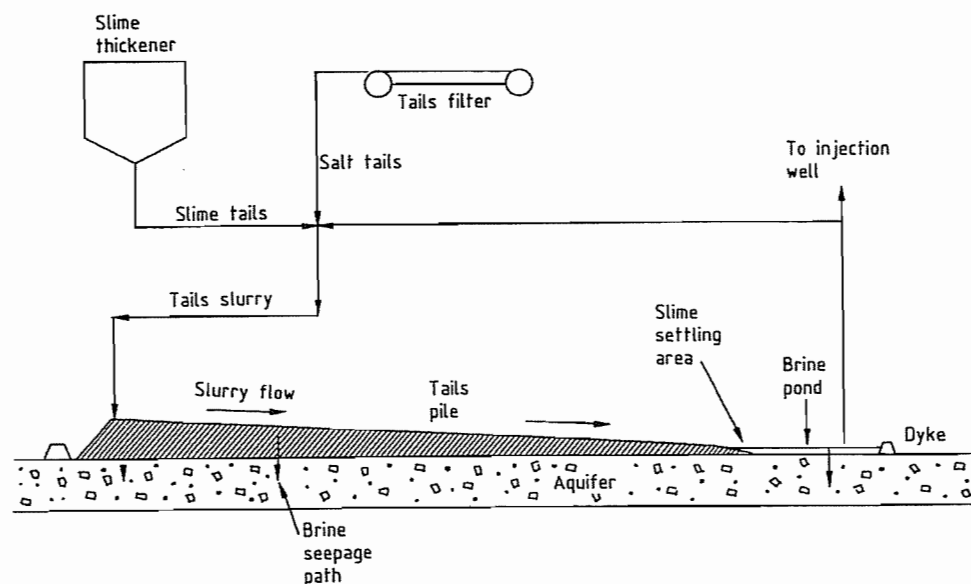

Figure 52.37: Conventional potash waste handling in Saskatchewan [217]. Reproduced with permission.

The compaction product consists of irregularly shaped angular particles. Handling causes abrasion of the edges and corners to form unwanted dust. The granular material is therefore usually treated with water after screening and then dried in a fluidized-bed dryer at 180–200 °C. This smooths the corners and edges, and gives a dense surface to the granules. Another method of dust reduction is to treat the granules with liquids that bind the dust formed by abrasion.

### 52.11.10 Quality Specifications

The main application of potassium chloride is in potash fertilizers, either as a single-nutrient fertilizer or as the potash component in mixed or complex fertilizers. In English-speaking areas and on the international market it is often called muriate of potash (MOP).

Single-nutrient fertilizers, which were formerly the most common type, have been replaced largely by complex or mixed fertilizers. Also, the finely divided fertilizers formerly used have increasingly been replaced by granulated products. Single potash fertilizers often contain the additional nutrient magnesium sulfate.

Potassium chloride must have differing grain structure and nutrient content depending on its intended use, e.g., for the production of granulated NPK or PK fertilizers, for application as suspension or liquid fertilizers, for bulk blending with other components, or as a single-nutrient fertilizer. The potash industry has developed internationally accepted quality standards.

The three main grades differ in grain size:

|          |            |
|----------|------------|
| Standard | 0.2–0.8 mm |
| Coarse   | 0.8–2.0 mm |
| Granular | 1.2–3.5 mm |

Other products, such as those designated soluble, special standard, or special fine, can contain a high proportion of grains < 0.2 mm. Grain-size distributions of the principal grades are listed in Table 52.10. Products from various manufacturers can diverge considerably from these specifications.

The granular and coarse products are used for bulk blending with other granulated fertilizers

or as single-nutrient fertilizers. The standard and other fine materials are used in the manufacture of granulated multinutrient fertilizers, and for suspension and liquid fertilizers.

The potassium chloride content, which for fertilizers is usually given as % K<sub>2</sub>O (100% KCl = 63% K<sub>2</sub>O), is generally at least 60% K<sub>2</sub>O (95% KCl) for this application. The main impurities include sodium chloride, or magnesium sulfate, and sometimes anhydrite or clay minerals, depending on the raw materials and production method. Fertilizer-quality potassium chloride produced by flotation is often colored red to red-brown by hematite inclusions or salt clay.

For single-nutrient fertilization, especially in European agriculture, potash fertilizers with a low K<sub>2</sub>O content are often used. These generally contain a guaranteed level of water-soluble magnesium salts. In Germany, for example, two granulated potash fertilizers with a guaranteed MgO content are widely used: 40er Kornkali with MgO (40% K<sub>2</sub>O, 6% MgO) and Magnesia-Kainit coarse (11% K<sub>2</sub>O, 5% MgO, 24% Na<sub>2</sub>O).

About 5% of the potassium chloride produced worldwide is used as an industrial chemical, mainly for the production of potassium hydroxide (see Section 52.13) and chlorine by chlor-alkali electrolysis. Material of this quality is produced by recrystallizing low-purity potassium chloride. A distinction is made between industrial-grade and chemical-grade material, depending on the impurity content and area of use. Typical analyses of these products are

|                   |       |            |
|-------------------|-------|------------|
| Industrial grade: | KCl:  | 99.0–99.5% |
|                   | NaCl: | 0.8–0.3%   |
| Chemical grade:   | KCl:  | 99.8–99.9% |
|                   | NaCl: | 0.05–0.03% |

The remaining impurities consist mainly of bromide and alkaline-earth sulfates, depending on the raw material and production process.

Dust content and free-flowing properties are important quality criteria, and depend on chemical composition and grain size. With granulated materials, dust formation by abrasion occurs due to handling during manufacture and transport even if the materials are

specially treated during production. To bind the dust, the granulated material is treated with conditioning agents such as polyglycols, mineral oil products, vegetable oils and waxes, or mixtures of these. The addition rates are usually 0.3–5.0 kg/t [228, 229]. Various methods have been developed to assess or measure the abrasion resistance and dust content of the granulated product. Abrasion resistance is tested by subjecting samples of the granules to a process of screening or rolling in a rotating drum with steel spheres or rods, and weighing the fine material formed after a given time [230]. Dust content is determined by air blowing a sample under precisely defined conditions and weighing the dust collected [228].

Fine potassium chloride (standard quality or finer) tends to cake on storage or transport over long distances. Anticaking agents are therefore generally added, usually mixtures of aliphatic amines, or sometimes higher fatty acids. Salt products that do not contain alkaline-earth sulfates are treated with potassium hexacyanoferrate(II). Addition rates for organic anticaking agents are 50–300 g/t, but potassium hexacyanoferrate(II) is effective even at 15–25 g/t [228, 229]. Anticaking agents can affect the wettability of potassium chloride, which in turn can affect its granulation properties when complex fertilizers are being produced. The anticaking treatment must therefore suit the user's requirements exactly [231].

### 52.11.11 Toxicology and Occupational Health

No toxic hazards are associated with the normal handling of potassium chloride. According to USP XVII of 1970, the usual therapeutic dose (e.g., for treating potassium deficiency) taken orally would be 1–10 g/d. The LD<sub>50</sub> (oral, guinea pig) is 2500 mg/kg.

Protective measures for storage and handling and personal protection such as breathing apparatus or gloves are unnecessary.

### 52.11.12 Economic Aspects and Uses [82, 232, 233]

Germany was the sole producer up to World War I, and was later joined by France and the United States, and then Spain, the Soviet Union, and Poland. After World War II, the leading producers were the central and western European countries and the United States. In the 1960s, the Soviet potash industry grew strongly, and the Soviet Union became the leading producer. Also in the 1960s, the first potash works in Saskatchewan was started up. In a few years, several large potash works were in operation there, and Canada became the second largest producer after the Soviet Union. The capital investment in the Soviet Union and Canada and the rapidly increasing use of fertilizers in agriculture in the 1960s and 1970s led to a steep increase in world potash production. Since 1980, the average annual increase in world potash production has been only 0.7%.

Almost two-thirds of world potash production is exported. All the potash-producing countries are exporters except for Brazil and China. Canada is by far the largest exporter.

The economic situation, particularly in developed countries, greatly influences the extent and regional distribution of exports. Both the quantity exported and its distribution among consumers are greatly affected by the state of their agriculture, especially in developed regions, and by the demand for or availability of convertible currency in the exporting or importing country. Transport costs for potash fertilizers have a considerable bearing on total cost to the consumer, and logistical considerations also influence the direction and size of exports or imports. Finally, fluctuations in the rate of exchange of currencies between the countries concerned are very important.

Because of the conditions described above, certain special regional relationships developed. The agricultural requirements of the former COMECON countries were satisfied by the Soviet and East German potash industries only. In western Europe, the market was supplied almost entirely by western European

producers. In North America, Canadian and United States producers were in a dominating position. Canada had a good export market in Asia, as did Europe and Jordan. The Latin American market was supplied mainly by Canadian producers, together with East Germany and the Soviet Union. In recent years, the political and economic changes in the former Eastern Bloc, the unification of Germany, and the collapse of the dollar have all led to changes in the supply demand relationships described above, although the distance between the producer and the consumer is still of overriding importance. The future development of potash exports will be influenced greatly by imports into China and Brazil. Both countries have only minimal production and are compelled to import fertilizers on a large scale. Problems associated with their internal economies and with foreign exchange have thus far limited imports [234, 235].

The capacities of the potash producers in various countries for 1990–1991 (in  $10^3$  t  $K_2O$ ) were [233]:

|                           |        |
|---------------------------|--------|
| Middle and Western Europe | 8 700  |
| Germany                   | 5 700  |
| France                    | 1 500  |
| Spain                     | 750    |
| Italy                     | 250    |
| United Kingdom            | 500    |
| North America             | 13 028 |
| United States             | 1 838  |
| Canada                    | 11 190 |
| Soviet Union              | 12 880 |
| Western Asia              | 2 220  |
| Israel                    | 1 380  |
| Jordan                    | 840    |
| Brazil                    | 150    |
| China                     | 50     |
| Others                    | 200    |
| Total                     | 37 218 |

Estimated world demand for potash fertilizers in the business year 1990–1991 by regions (in 1000 t  $K_2O$ ) was as follows:

|                 |       |
|-----------------|-------|
| Europe          | 7 520 |
| Eastern Europe  | 2 120 |
| Western Europe  | 5 400 |
| Soviet Union    | 5 600 |
| America         | 7 320 |
| North America   | 5 100 |
| Central America | 350   |
| South America   | 3 190 |
| Asia            | 4 705 |
| Western Asia    | 155   |
| Southern Asia   | 1 360 |
| Eastern Asia    | 3 190 |

|         |        |
|---------|--------|
| Africa  | 522    |
| Oceania | 260    |
| World   | 25 927 |

In using these figures, it should be borne in mind that the capacities quoted by individual producers are generally too high and that only ca. 95 % of the total potash production is used in the form of fertilizers. Hence, the total consumption of products of the potash industry is ca.  $1.5 \times 10^6$  t of  $K_2O$  higher than the figure given above. Nevertheless, considerable overcapacity exists worldwide, as can be seen by comparing the two tables.

Industrial-grade and chemical-grade potassium chloride are used mainly for the electrolytic production of potassium hydroxide. Other important uses include the production of drilling fluids for the oil industry, aluminum smelting, metal plating, production of various potassium compounds, and applications in the food and pharmaceutical industries [236].

## 52.12 Potassium Sulfate [237]

Potassium sulfate,  $K_2SO_4$ , mineral name arcanite, forms colorless, nonhygroscopic crystals. It occasionally occurs in nature in the pure state in salt deposits (e.g., in Germany, the United States, and the CIS) but is more widely found in the form of mineral double salts in combination with sulfates of calcium, magnesium, and sodium (Table 52.3). Potassium sulfate is, after potassium chloride, the most important potassium-containing fertilizer, being used mainly for special crops. Potassium sulfate constitutes ca. 5 % of the world demand for potash fertilizers.

### 52.12.1 Properties

Potassium sulfate forms orthorhombic crystals, which transform to the trigonal modification at 583 °C. Some properties of potassium sulfate are listed below:

|                                     |                             |
|-------------------------------------|-----------------------------|
| $f_p$                               | 1069 °C                     |
| Crystal system and type             | orthorhombic, $D_{2h}^{16}$ |
| Phase change at                     | 583 °C                      |
| Crystal system and type at > 583 °C | trigonal, $D_{3d}^3$        |
| Refractive indices $n_D^{20}$       | 1.4933; 1.4946;<br>1.4973   |
| Density                             | 2.662 g/cm <sup>3</sup>     |

|  |   |
|--|---|
| Specific heat capacity $c_p$                   | 752.9 J kg <sup>-1</sup> K <sup>-1</sup>  |
| Heat of fusion                                 | 197.4 kJ/kg                               |
| Heat of transformation (orthorhombic/trigonal) | 48.5 kJ/kg                                |
| Enthalpy of formation $\Delta H^0$             | -1438 kJ/mol                              |
| Entropy $S^0$                                  | 175.6 J mol <sup>-1</sup> K <sup>-1</sup> |
| Dielectric constant (at $4 \times 10^8$ Hz)    | 6.3                                       |
| Thermal coefficient of expansion (cubic)       | $130 \times 10^{-6}$ K <sup>-1</sup>      |

Apart from the naturally occurring double-salt minerals mentioned above, potassium sulfate also forms double salts and mixed crystals with ammonium sulfate and the sulfates of beryllium, magnesium, calcium, strontium, barium, and lead. It is reduced to potassium sulfide or potassium polysulfides by reducing agents such as hydrogen and carbon monoxide at high temperature.

The solubility of potassium sulfate in water is listed in Table 52.11. The cryohydric point is -1.51 °C (7.1 g  $K_2SO_4$ /100 g  $H_2O$ ), and the boiling point of the saturated solution is 101.4 °C (24.3 g  $K_2SO_4$ /100 g  $H_2O$ ). The solid phases formed in the system  $K_2SO_4$ - $H_2O$  are  $K_2SO_4$ ,  $K_2SO_4 \cdot H_2O$ , and ice. In aqueous ammoniacal solution, the solubility decreases rapidly with increasing ammonia concentration [238]. Potassium sulfate is virtually insoluble in industrial organic solvents.

Table 52.11: Solubility of potassium sulfate in water (g/100 g) [93].

| Temperature, °C | Solubility | Temperature, °C | Solubility |
|-----------------|------------|-----------------|------------|
| 0               | 7.35       | 60              | 18.4       |
| 10              | 9.24       | 70              | 20.0       |
| 20              | 11.1       | 80              | 21.5       |
| 30              | 12.9       | 90              | 22.8       |
| 40              | 14.8       | 100             | 24.0       |
| 50              | 16.6       |                 |            |

### 52.12.2 Raw Materials

Potassium sulfate is produced from single or mixed minerals or brines, or by the reaction of potassium chloride with sulfuric acid or sulfates [239]. The economically important minerals include the deposits of hard salt in Germany, langbeinite in New Mexico (United States), and kainite in Sicily. In the United States, sulfate-containing crystalline products from the evaporation of water from the Great Salt Lake (Utah) and Searles Lake (California)

are also used for the production of potassium sulfate.

Potassium chloride is usually converted to potassium sulfate by reaction with sulfuric acid, but  $SO_2$ -air mixtures can also be used. Reactions with sodium sulfate and gypsum have recently become of interest. Small amounts of potassium sulfate are obtained during the production of alumina from alunite.

## 52.12.3 Production

The choice of production method and the location of a potassium sulfate plant depend on having a plentiful economic supply of the starting materials and being able to utilize or dispose of the by-products or waste. Most production plants are located on salt deposits from which at least some of the raw materials can be obtained. Plants in which potassium chloride is reacted with sulfuric acid with liberation of hydrogen chloride are usually located in regions with a demand for hydrochloric acid, (e.g., for an acidification of petroleum boreholes), or they operate in conjunction with a chemical works having a process that uses hydrogen chloride. In such cases, the exploitability of hydrogen chloride determines the capacity of the potassium sulfate plant.

### 52.12.3.1 From KCl and $H_2SO_4$ (Mannheim Process)

The reaction of sulfuric acid with potassium chloride takes place in two stages:

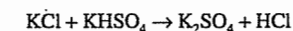
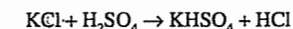

The first reaction step is exothermic and proceeds at relatively low temperature. The second is endothermic and must be carried out at higher temperature. The relationship between total reaction time and temperature is shown in Figure 52.38. In practice, the process is operated at 600–700 °C. To minimize the chloride content of the product, a small excess of sulfuric acid is used, which is later neutralized with calcium carbonate or potassium carbon-

ate, depending on the purity requirements for the product.

The reaction is usually carried out in so-called Mannheim furnaces (Figure 52.39) [240].

The furnace has a closed dish-shaped chamber, with diameter up to 6 m, heated externally by an oil or gas burner. Potassium chloride and sulfuric acid are fed into the chamber in the required ratio at an overhead central point. The mixture reacts with evolution of heat and is mixed by a slowly moving stirrer fitted with stirring arms with scrapers (rabblers), which propels the mixture from the center of the chamber to the periphery. Potassium sulfate leaves the reaction chamber at this point and is neutralized and cooled. It normally contains 50–52%  $K_2O$  and 1.5–2% chloride. Hydrogen chloride gas formed is absorbed in water to form hydrochloric acid or used in gaseous form.

The Mannheim process is the most widely used method of producing potassium sulfate due to its simplicity, high yield, and the many ways in which the by-product can be utilized. Hydrogen chloride is used to produce dicalcium phosphate, vinyl chloride, or calcium chloride if it cannot be sold as hydrochloric acid.

Disadvantages of the process include high energy consumption, severe corrosion, and high capital cost. In the United States, reductions in corrosion and energy consumption are

achieved by using the Cannon process, in which the reaction is carried out in a directly fired fluidized bed.

Another variation is the Hargreaves process, which is also used in the United States. Briquetted potassium chloride is heated in reaction chambers in a stream of sulfur dioxide from the combustion of sulfur, excess air, and water vapor. The yield and the degree of conversion are both ca. 95%.

The Mannheim and Hargreaves processes are also used to produce sodium sulfate from sodium chloride and sulfuric acid. Mannheim furnaces can be used to produce potassium and sodium sulfates alternately. Recent research into the reaction of potassium chloride with sulfuric acid in a liquid-liquid extraction process did not result in the construction of a production plant [241, 242].

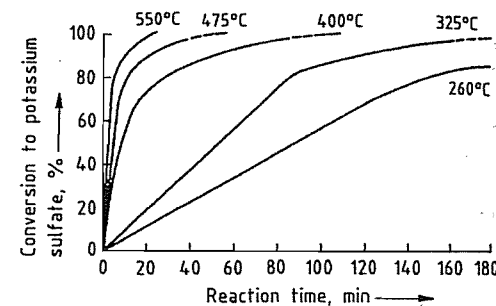

Figure 52.38: Temperature dependence of the reaction between chloride and sulfuric acid. Reproduced from [240] with permission.

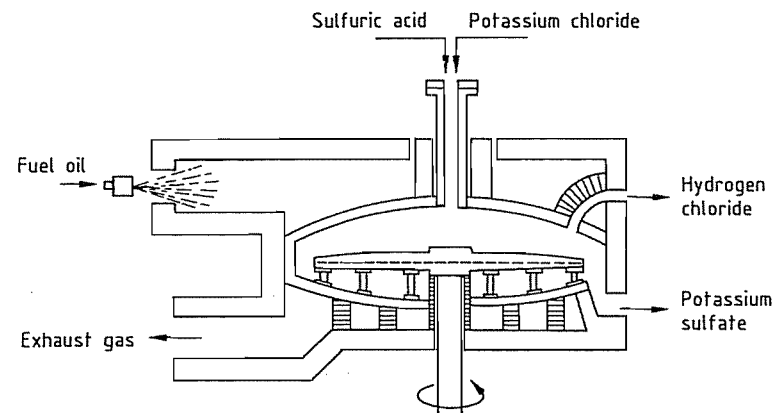

Figure 52.39: Schematic diagram of a Mannheim furnace. Reproduced from [240] with permission.

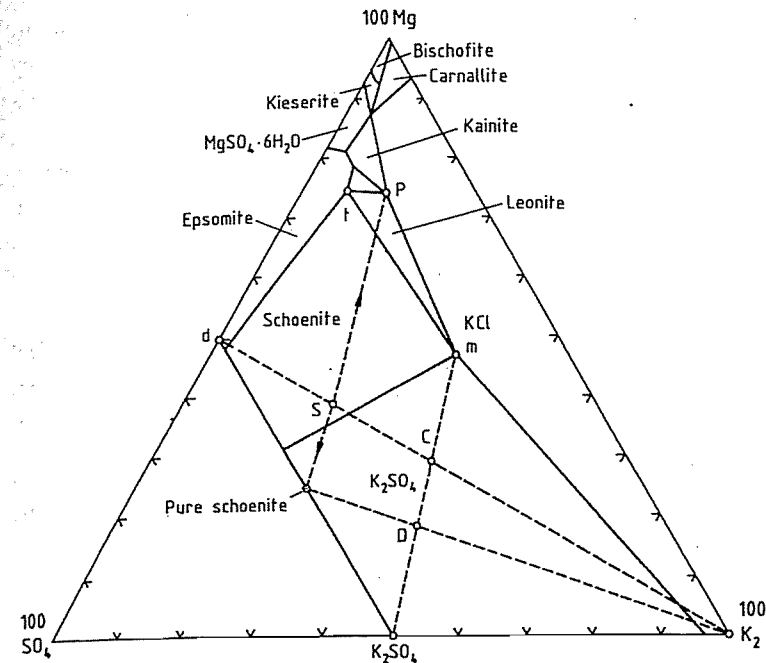

Figure 52.40: Isothermals of the system  $K_2$ -Mg-Cl<sub>2</sub>-SO<sub>4</sub>-H<sub>2</sub>O at 25 °C according to JÄNECKE.

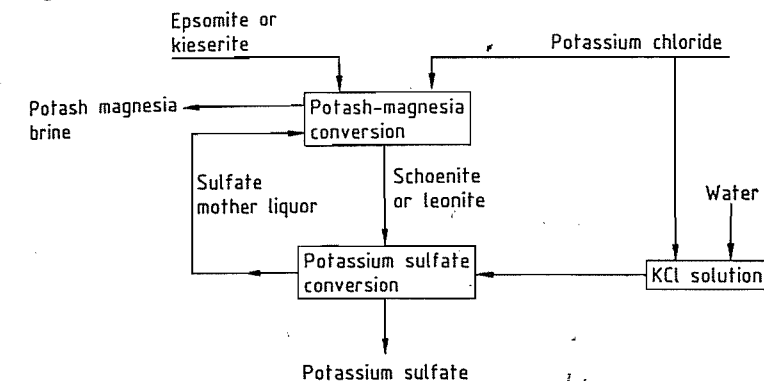
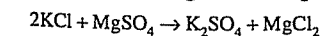

Figure 52.41: Flow diagram of the two-stage production of potassium sulfate from potassium chloride and magnesium sulfate.

### 52.12.3.2 From KCl and $MgSO_4$ [243, 244]

In a process used mainly in Germany, the sulfate required is provided by kieserite,  $MgSO_4 \cdot H_2O$ , a component of German hard salt deposits. The reaction can be represented by the following overall equation:



Kieserite reacts very slowly and must be ground finely before reaction. Alternatively, it can first be recrystallized to give epsomite,  $MgSO_4 \cdot 7H_2O$ .

The basis of the process is explained in Figure 52.40. The fundamental relationships for the single-stage process of KUBIERSCHKY and the two-stage process of KOELICHEN and PRZI-

BYLLA are shown as broken lines on the isotherm diagram.

For the single-stage process, the most favorable mixing ratio of the starting materials is given by point C. In the presence of sufficient water, this mixture reacts to form potassium sulfate and a sulfate mother liquor (point m). This solution has the highest magnesium chloride content attainable by direct reaction, which determines the yield. The magnesium content of solution m reaches a maximum at 25 °C, and the process is therefore carried out at this temperature. The single-stage process achieves a theoretical potassium yield of only 46.1 % and sulfate yield of 67.5 %.

For this reason, the two-stage process is now used exclusively. In this process, the starting materials are first mixed in the presence of a definite quantity of water corresponding to point S to form schönite,  $K_2SO_4 \cdot MgSO_4 \cdot 6H_2O$ . So-called potash-magnesia liquor, which has a high magnesium chloride content (point P), is also formed. The schönite is reacted with additional potassium chloride (point D) to form potassium sulfate and sulfate mother liquor:

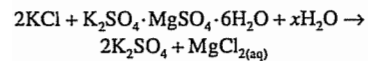
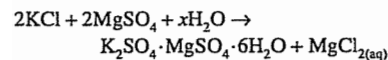

This process gives a theoretical potassium yield of 68 % and sulfate yield of 83.7 %.

The flow diagram of the process is shown schematically in Figure 52.41.

In the first stage, called the potash-magnesia stage, schönite or leonite,  $K_2SO_4 \cdot MgSO_4 \cdot 4H_2O$ , is produced by stirring solid epsomite or finely ground kieserite with potassium chloride in sulfate mother liquor recycled from the second stage. The suspension produced is filtered on rotary filters; the potash-magnesia brine, which contains 180–200 g/L magnesium chloride, is removed; and the solid crystalline product, also known as potash-magnesia, is fed to the next stage, sometimes after being washed with sulfate mother liquor, where it is stirred with potassium chloride solution at ca. 70 °C. The temperature of the

mixture is 35–40 °C, and solid potassium sulfate is formed. This is thickened, debrined by centrifuges, and dried in drum or fluidized-bed dryers.

If the sulfate reaction is carried out in a classifying crystallizer at a high solids content [245], a very pure, coarsely crystalline product is obtained with  $K_2O$  content of 53 % and chloride content of < 0.5 %.

In the industrial process, sodium chloride is always present. If the molar ratio of  $Na_2:K_2$  in the sulfate mother liquor exceeds 2:5, glaserite,  $3K_2SO_4 \cdot Na_2SO_4$ , is formed instead of potassium sulfate. To prevent this, the potassium chloride used must be of adequate purity.

The yield is determined by losses to the waste brine. The higher the magnesium chloride content of the potash-magnesia brine is, the lower is the potassium content, and therefore the potassium loss. Excess potassium-rich sulfate mother liquor must be recovered.

### 52.12.3.3 From KCl and Langbeinite [246]

Large deposits of langbeinite,  $K_2SO_4 \cdot 2MgSO_4$ , can be found in New Mexico (United States). Langbeinite can be converted to potassium sulfate according to the following overall equation:



The potash ore also contains halite and varying amounts of sylvite, from which langbeinite is separated by gravity separation, flotation, and dissolution of halite, giving various crystal sizes. The coarser langbeinite fraction is sold as potash-magnesium fertilizer, and the finer fraction is reacted with potassium chloride to produce potassium sulfate. A flow diagram for the process is given in Figure 52.42.

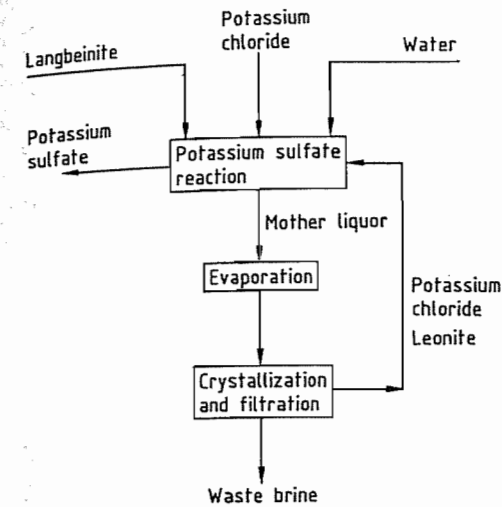

Figure 52.42: Flow diagram of the production of potassium sulfate from langbeinite.

The potassium sulfate formed is granulated and marketed in three different grain sizes: granular (0.8–3.4 mm), standard (0.2–1.6 mm), and special standard. The latter has a high content of grains < 0.2 mm.

### 52.12.3.4 From KCl and Kainite [239]

In Sicily, kainite,  $KCl \cdot MgSO_4 \cdot 2.75H_2O$ , is obtained from a potash ore by flotation. It is then converted into schönite at ca. 25 °C by stirring with mother liquor containing the sul-

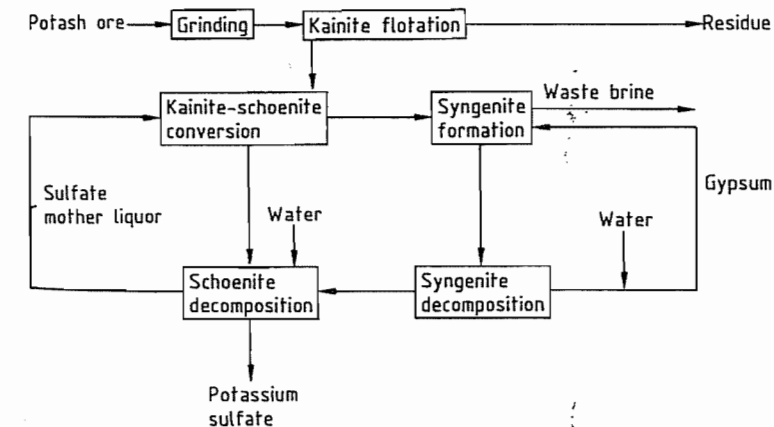
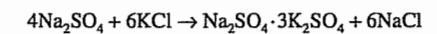

Figure 52.43: Flow diagram of the production of potassium sulfate from kainite.

fates of potassium and magnesium from the later stages of the process. Schönite is filtered off and decomposed with water at ca. 48 °C. This causes magnesium sulfate and part of the potassium sulfate to dissolve and most of the potassium sulfate to crystallize. The crystals are filtered and dried. The sulfate mother liquor is recycled to the kainite-schönite conversion stage. The mother liquor produced there, which still contains ca. 30 % of the potassium used, is treated with gypsum,  $CaSO_4 \cdot 2H_2O$ , causing sparingly soluble syngenite,  $K_2SO_4 \cdot CaSO_4 \cdot H_2O$ , to precipitate. Syngenite is decomposed with water at ca. 50 °C, which dissolves potassium sulfate and reprecipitates gypsum. The potassium sulfate solution is recycled to the schönite decomposition stage, and gypsum is reused to precipitate syngenite. A simplified flow diagram of the process is given in Figure 52.43.

### 52.12.3.5 From KCl and $Na_2SO_4$ [242]

The production of potassium sulfate from potassium chloride and sodium sulfate takes place in two stages, with glaserite,  $Na_2SO_4 \cdot 3K_2SO_4$ , as an intermediate, according to the following equations:



Potassium chloride and sodium sulfate are reacted at 20–50 °C in water and recycled process brines to form glaserite, which is filtered and then reacted with more potassium chloride and water to form potassium sulfate. Because the mother liquor from the glaserite stage has a high potassium and sulfate content, the maximum potassium yield is 73%, and the maximum sulfate yield is 78%. The yield can be increased considerably by cooling the mother liquor to produce more crystals and by including a final evaporation stage.

A production plant in the CIS uses the glaserite process [244], and an experimental plant is operating in Canada [247].

Alternatively, sodium sulfate solution can be used to charge an anion exchanger with sulfate, which reacts with potassium chloride solution to give a high yield of potassium sulfate [248, 249]. This process is used at Quill Lake, Saskatchewan, Canada, which has a high sodium sulfate content.

### 52.12.3.6 From KCl and CaSO<sub>4</sub>

Processes based on gypsum, CaSO<sub>4</sub>·2H<sub>2</sub>O, have often been proposed, because it is so readily available. Two processes have been tested in experimental plants:

- Reaction with potassium chloride in strongly ammoniacal solution
  - Reaction with anion exchangers
- Potassium chloride reacts with gypsum in water to give syngenite. If the reaction is carried out in a concentrated solution of ammonia at low temperature, potassium sulfate with a very low syngenite content is obtained [241, 250, 251].

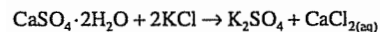

By carrying out the reaction in two or more stages, high concentrations of calcium chloride in the waste brine can be produced, and hence very high yields. The ammonia required for the reaction medium must be recovered by distillation. This process has recently attracted some interest [252].

The anion-exchange process is carried out in two stages [253]. First, the ion-exchange

resin (R) is treated with a suspension of gypsum, charging it with sulfate. The charged resin is then treated with a concentrated solution of potassium chloride, to replace the dissolved chloride by sulfate. Potassium sulfate crystallizes from the solution, sometimes after the addition of solid potassium chloride. The process takes place according to the following equations:

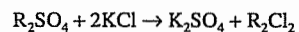
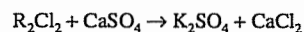

### 52.12.3.7 From Alunite [254]

Alunite, K<sub>2</sub>SO<sub>4</sub>·Al<sub>2</sub>(SO<sub>4</sub>)<sub>3</sub>·4Al(OH)<sub>3</sub>, occurs in several extensive deposits. On being heated to 800–1000 °C, it decomposes with liberation of sulfur trioxide to form a mixture of alumina and potassium sulfate. The latter can be extracted from the mixture. A plant in the CIS uses this process.

### 52.12.3.8 From Natural Brines and Bitterns

In the United States, large quantities of potassium sulfate are produced from the brines of the Great Salt Lake and smaller amounts from the brines of Searles Lake. Extensive investigations and project studies have been carried out in various countries into the extraction of potassium sulfate from the mother liquors (bitterns) produced when salt is extracted from seawater, and from concentrated brines in Tunisia and the Atacama desert of Chile [242].

### 52.12.4 Granulation

The demand for granulated potassium sulfate has increased greatly in recent years for the same reasons that the demand for potassium chloride has increased. The method of production with compaction rolls is widely used (see Section 52.11.9), although potassium sulfate does not behave under pressure like potassium chloride, which undergoes plastic deformation with merging of the grain boundaries. However, the granulated product is much more dense and solid if the potassium

sulfate is wetted before compaction by adding up to 2% water, or if steam is introduced through force feeders located above the compaction rolls. Also, the pressure used must be considerably higher than that for potassium chloride [255, 256]. A compaction plant for potassium sulfate is otherwise similar to that for potassium chloride, although the throughput is much lower.

### 52.12.5 Quality Specifications

The important quality specifications for agricultural-grade potassium sulfate, known in the English-speaking world and on the international market as sulfate of potash (abbreviated to SOP), are the K<sub>2</sub>O and chloride content. All producers guarantee a minimum K<sub>2</sub>O content of 50% (92.5% K<sub>2</sub>SO<sub>4</sub>), typical values being 50.5–51.0%. A completely water-soluble potassium sulfate with K<sub>2</sub>O content of > 52% is supplied for the production of liquid fertilizers.

The maximum permissible chloride content is 3%, according to EC Guidelines, but the usual commercial upper limit is 2.5%. The chloride content depends very much on the production method, and some producers offer potassium sulfate with chloride content < 0.5%.

The most common impurities, apart from alkali chlorides, are the sulfates of calcium and magnesium.

The demand for granulated potassium sulfate as a single-nutrient fertilizer and for bulk blending has greatly increased. The crystal size and size distribution of the products granular, coarse, and standard are the same as those for potassium chloride.

Potassium sulfate does not cake as readily as potassium chloride and is therefore not treated with anticaking agents. Dust-reducing agents are added at the rate of 5 kg/t to the fine and granulated products; the same additives are used as for potassium chloride.

Industrial-grade potassium sulfate with a K<sub>2</sub>SO<sub>4</sub> content of 99.6–99.9%, purified by recrystallization, is supplied as a raw material for the production of other potassium com-

pounds and as an auxiliary material or reagent for various branches of industry. Specifications with respect to chemical purity and crystal size distribution are suited to the individual user's requirements and can sometimes be very detailed.

### 52.12.6 Toxicology and Occupational Health

No health hazard is associated with potassium sulfate if it is handled in accordance with regulations. According to Swiss law relating to toxic substances, it is a Class 4 material (LD<sub>50</sub>: 500–5000 mg/kg). Otherwise, the information given in Section 52.11.11 for potassium chloride applies.

### 52.12.7 Economic Aspects and Uses

Potassium sulfate accounts for ca. 5% of world production by the potash industry, expressed in K<sub>2</sub>O units. It is produced in 11 countries. Of the total, ca. two-thirds comes from Belgium and Germany. Other European producers are Italy, Spain, Finland, and Sweden. Potassium sulfate is also produced by the CTS. Other production plants are in the United States, Japan, South Korea, Taiwan, the Philippines, and recently, China. Present world production and consumption both exceed 1.5 × 10<sup>6</sup> t K<sub>2</sub>O [257, 258].

Potassium sulfate is up to twice as expensive as potassium chloride based on K<sub>2</sub>O content due to the costs of the raw material (potassium chloride) and processing. It is therefore only used as a potash fertilizer for applications where it performs much better than potassium chloride.

The sulfur content of potassium sulfate is an advantage where there is a deficiency of sulfur in the soil. Also, it has only a slight oversalting effect on soil in arid or semiarid areas. It is useful for fertilizing crops that are sensitive to chloride or whose quality is improved by chloride-free fertilization. This applies particularly to tobacco, vegetables,



potatoes, vines, and citrus or various other fruit [257, 259].

Potassium sulfate is used in industry for the production of other potassium compounds, accelerators for rapid-setting cements, synthetic rubbers, desensitizers for explosives, lubricants, powdered fire extinguishers, dyes, explosives, and pharmaceuticals.

## 52.13 Potassium Hydroxide

[273–276]

### 52.13.1 Properties

Pure, solid potassium hydroxide, KOH, caustic potash,  $\rho$  2.044 g/cm<sup>3</sup>, *mp* 410 °C, *bp* 1327 °C, heat of fusion 7.5 kJ/mol, is a hard, white substance. It is deliquescent and absorbs water vapor and carbon dioxide from the air. Potassium hydroxide dissolves readily in alcohols and water (heat of solution 53.51 kJ/mol). The solubility of KOH (g KOH/100 g H<sub>2</sub>O) in water is shown below:

|                 |    |     |     |     |     |     |
|-----------------|----|-----|-----|-----|-----|-----|
| Temperature, °C | 0  | 10  | 20  | 30  | 50  | 100 |
| Solubility      | 97 | 103 | 112 | 126 | 140 | 178 |

The mono-, di-, and tetrahydrates are formed with water. Aqueous potassium hydroxide is a colorless, strongly basic, soapy, caustic liquid, whose density depends on the concentration:

|                            |       |       |       |       |       |
|----------------------------|-------|-------|-------|-------|-------|
| Concentration, %           | 10    | 20    | 30    | 40    | 50    |
| Density, g/cm <sup>3</sup> | 1.092 | 1.188 | 1.291 | 1.395 | 1.514 |

Technical caustic potash (90–92% KOH) melts at ca. 250 °C; the heat of fusion is ca. 6.7 kJ/mol.

### 52.13.2 Production

Today, potassium hydroxide is manufactured almost exclusively by potassium chloride electrolysis. The diaphragm, mercury, and membrane processes are all suitable for the production of potassium hydroxide, but the mercury process is preferred because it yields a chemically pure 50% potassium hydroxide solution.

In the *diaphragm process*, a KCl-containing, 8–10% potassium hydroxide solution is initially formed, whose salt content can be reduced to ca. 1.0–1.5% KCl by evaporation to a

50% liquor. Further purification is complicated, and the quality of liquor from mercury cells cannot be achieved.

In the *mercury process* a very pure KCl brine must be utilized, because even traces (ppb range) of heavy metals such as chromium, tungsten, molybdenum, and vanadium, as well as small amounts (ppm range) of calcium or magnesium, lead to strong evolution of hydrogen at the amalgam cathode. The very pure potassium hydroxide solution running off the decomposers is cooled, freed from small amounts of mercury in precoated filters, and in some cases sent immediately to the consumer as a 45–50% liquor in drums, tank cars, or barges.

Since about 1985, new cell rooms for the manufacture of potassium hydroxide solution have used the *membrane process*. At present, the cell liquor has a low chloride content (10–50 ppm); the KOH concentration is 32%. Before dispatch, it is concentrated to 45–50% by evaporation.

Nonelectrochemical processes have been proposed for the manufacture of chlorine and potassium hydroxide from KCl by thermal decomposition of potassium nitrite in the presence of Fe<sub>2</sub>O<sub>3</sub> [277].

This method involves reacting KCl with NO<sub>2</sub> to obtain Cl<sub>2</sub> and potassium nitrite, reacting the KNO<sub>2</sub> with iron(III) oxide and oxygen to give potassium ferrate (K<sub>2</sub>Fe<sub>2</sub>O<sub>4</sub>), and reacting the ferrate with water to produce KOH. Another method consists of reacting an aqueous solution of KCl with NO<sub>2</sub> and O<sub>2</sub> to give Cl<sub>2</sub> and KNO<sub>3</sub>, which is reacted with water in the presence of Fe<sub>2</sub>O<sub>3</sub> to produce KOH.

Largely water-free, ca. 90–95% potassium hydroxide (caustic potash) is obtained by evaporating potassium hydroxide solution. The residual content of 5–10% H<sub>2</sub>O is bound as a monohydrate.

Suitable evaporation processes are single- or multistage falling-film evaporators [278], Badger single-tube evaporators, or boilers connected in cascade. Heating is carried out with steam or by means of heat-transfer agents (salt melts, Dowtherm). Flash evaporators are

used as the final stage in large-capacity plants [279].

To counter the strong corrosiveness of the potassium hydroxide solution and retain the purity of the caustic potash, the equipment is made largely from high-purity nickel (LC 99.2) or is silverplated. The equipment is often protected by polarization.

For dispatch, caustic potash comes on the market poured directly into drums or packed in polyethylene bags after cooling; in blocks, molded pieces, flakes, prills, and as a powder. Potassium hydroxide is classified as a corrosive material:

|                                 |                             |
|---------------------------------|-----------------------------|
| UN no.                          | 1814 (for aqueous solution) |
| UN no.                          | 1813 (for dry material)     |
| GGVS/GGVE                       | Class 8                     |
| RID/ADR                         | Class 8                     |
| Handling is described in [280]. |                             |

### 52.13.3 Quality Specifications

Potassium hydroxide solution is supplied in pure quality [total alkalinity 49.7–50.3%, KOH 48.8% (min.), NaOH 0.5% (max.), CO<sub>3</sub><sup>2-</sup> 0.1% (max.)] or in technical quality [total alkalinity 49.7–50.3%, NaOH 1.0% (max.), CO<sub>3</sub><sup>2-</sup> 0.3% (max.)]. The contents of Cl<sup>-</sup>, SO<sub>4</sub><sup>2-</sup>, Fe<sup>2+</sup>, and Ca<sup>2+</sup> are < 30 ppm. Solid caustic potash produced from amalgam liquor has a total alkalinity (calculated as KOH) of 89–92%, NaOH 1.5% (max.), CO<sub>3</sub><sup>2-</sup> 0.5% (max.), Cl<sup>-</sup> 0.01% (max.). The values for SO<sub>4</sub><sup>2-</sup>, Fe<sup>2+</sup>, and Ni<sup>2+</sup> are < 50 ppm. Caustic potash from diaphragm electrolysis has a Cl<sup>-</sup> content of 2.5–3.0% and higher content of heavy metals.

### 52.13.4 Economic Aspects and Uses

Pure-quality potassium hydroxide is used as a raw material for the chemical and pharmaceutical industry, in dye synthesis, for photography as a developer alkali, and as an electrolyte in batteries and in the electrolysis of water. Technical-quality KOH is used as a raw material in the detergent and soap industry; as a starting material for inorganic and organic potassium compounds and salts (e.g.,

potassium carbonate, phosphates, silicate, permanganate, cyanide); for the manufacture of cosmetics, glass, and textiles; for desulfurizing crude oil; as a drying agent; and as an absorbent for carbon dioxide and nitrogen oxides from gases.

World production is estimated at ca. 700–800 × 10<sup>3</sup> t/a. Main producers are the United States [281], Germany, Japan, and France. Other important producer countries are Belgium, the United Kingdom, Italy, Spain, South Korea, India, Israel, Yugoslavia, former Czechoslovakia, Sweden, and Romania.

## 52.14 Potassium Carbonate

[273–276]

Potassium carbonate was produced in antiquity and used for many purposes. In the Old Testament, potash is mentioned in Jeremiah (written in the 7th century B.C.). ARISTOTLE describes the extraction of wood ash with water; the Romans manufactured soap from fat and potash. LAVOISIER identified potash as potassium carbonate.

The production of potash from wood ash for the manufacture of glass and soap was a flourishing industry in the Middle Ages in areas having a plentiful supply of wood such as Russia and also in Scotland. Since 1860, potash salts have replaced wood as a raw material for the manufacture of potassium carbonate.

In Anglo-American usage, the term potash today includes potassium carbonate as well as all potassium salts, such as KCl, K<sub>2</sub>SO<sub>4</sub>, and K<sub>2</sub>SO<sub>4</sub>·MgSO<sub>4</sub>·xH<sub>2</sub>O, that are used as fertilizers; the potassium content is given as K<sub>2</sub>O.

Potassium carbonate occurs in small amounts in a few African lakes (e.g., Lake Chad and in the vicinity of Lake Victoria), as well as in the Dead Sea.

### 52.14.1 Properties

Anhydrous potassium carbonate, K<sub>2</sub>CO<sub>3</sub>,  $\rho$  2.428 g/cm<sup>3</sup>, *mp* 891 °C, is a white, hygroscopic, powdery material that deliquesces in moist air. It is readily soluble in water with the formation of an alkaline solution. The solubil-

ity of  $K_2CO_3$  (g  $K_2CO_3/100$  g  $H_2O$ ) in water is given below:

| Temperature, °C | Solubility | Temperature, °C | Solubility |
|-----------------|------------|-----------------|------------|
| 0               | 105.5      | 60              | 126.8      |
| 10              | 108.0      | 70              | 133.1      |
| 20              | 110.5      | 80              | 139.8      |
| 30              | 113.7      | 90              | 147.5      |
| 40              | 116.9      | 100             | 155.7      |
| 50              | 121.2      |                 |            |

On addition of acid, potassium carbonate reacts with the evolution of carbon dioxide:

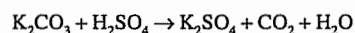

$K_2CO_3$  forms several hydrates, of which  $K_2CO_3 \cdot 1.5H_2O$  is the stable phase in contact with the saturated solution from 0 °C to ca. 110 °C. This hydrate ( $\rho$  2.155 g/cm<sup>3</sup>) crystallizes in glassy, virtually dust-free crystals. It is also hygroscopic and deliquesces in moist air. It is completely dehydrated at 130–160 °C.

## 52.14.2 Production

### From Caustic Potash and Carbon Dioxide.

The most important process for the manufacture of potassium carbonate begins with electrolytically produced potassium hydroxide solution. The almost chemically pure solution obtained by the mercury process is reacted with carbon dioxide or  $CO_2$ -containing off-gases (flue gas, lime kiln gas).

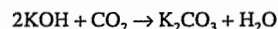

Solid potassium carbonate is then obtained by crystallization (under vacuum and with cooling) from liquors or in the fluidized-bed process.

In the continuous crystallization process (Figure 52.44), the filtered, fresh carbonate solution is mixed with mother liquor and concentrated in several preliminary evaporators connected in series until the hydrate  $K_2CO_3 \cdot 1.5H_2O$  finally precipitates in the crystallizer after cooling under vacuum [282]. The mother liquor is separated from the crystal suspension in hydrocyclones and centrifuges, filtered, and fed back to the process. The crystals are dried at ca. 110–120 °C in rotary kilns or fluidized-bed dryers and packed for sale as

potash hydrate, or they are calcined at 200–350 °C to give 98–100%  $K_2CO_3$ . Impurities such as soda, sulfate, silicic acid, and iron that concentrate in the mother liquors can be partially removed [283] by removing a partial stream of the mother liquor, which is either used for brine purification in the electrolysis process or sold as a low-grade potassium carbonate solution, or by crystallizing the double-salt  $NaKCO_3$  at elevated temperature in a separate crystallization and drying process.

The resulting potassium carbonate is very pure and meets the requirements of USP, BP, DAB, and JP if the process is operated in appropriate manner.

Starting from potassium carbonate solution, prills can be produced in a combined reactor, in which spray drying and fluidized-bed granulation take place simultaneously [284].

In the fluidized-bed process, aqueous potassium hydroxide solution is sprayed into a fluidized-bed reactor from above and exposed to a countercurrent of  $CO_2$ -containing hot gas (Figure 52.45) [285, 286]. Carbonization and calcination take place in the same reactor. Hard, spherical potassium carbonate prills are formed having a high packing density. The prills are discharged and sieved. The coarse grains are ground and returned to the reactor together with the very fine grains, where they act as crystallization seeds. The salable, dust-free, medium grains are cooled and packed. Because no mother liquor is formed, the quality of the potassium carbonate depends on that of the raw materials. Compared to the crystallization process the chloride, soda, and sulfate contents are usually higher, but the investment and production costs are lower.

**Amine Process.** In the Mines de potasse d'Alsace process, potassium chloride is reacted under pressure in autoclaves with carbon dioxide in precarbonated isopropylamine solution. Potassium hydrogencarbonate precipitates and is filtered off, carefully purified of amine by intensive washing, and dried. It can be converted to potassium carbonate by calcination. Free amine, containing carbon dioxide, is recovered from the mother liquor by distillation

and recycled. The chloride, predominantly present in the mother liquor as amine chlorohydrate, is reacted with hydrated lime to give

free amine and an aqueous solution of calcium chloride [287].

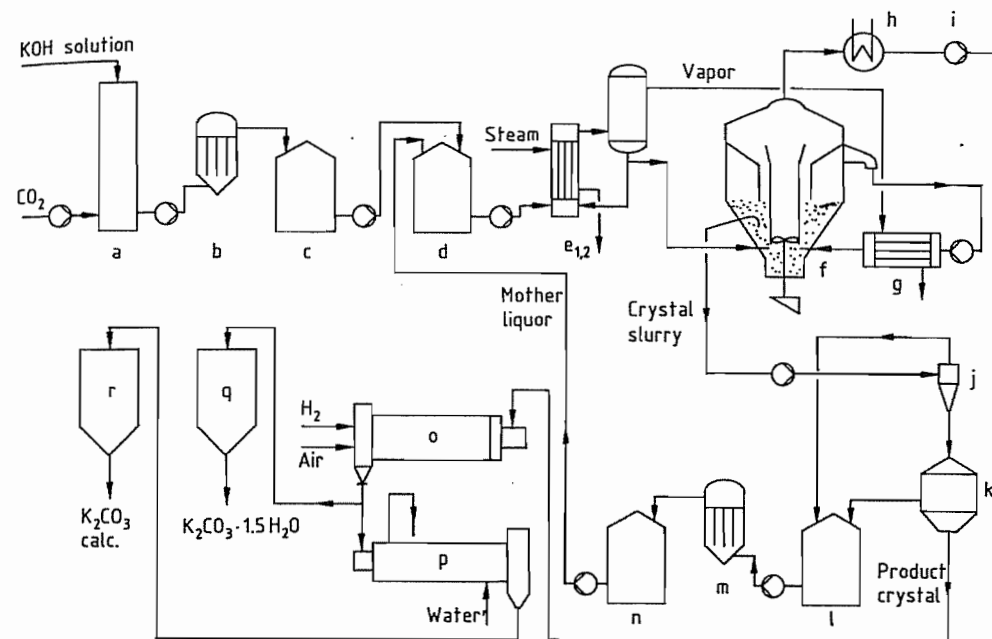

Figure 52.44: Preparation of potassium carbonate with continuous crystallization: a) Carbonization; b) Crude liquor filter; c) Fresh liquor tank; d) Mixed liquor tank; e<sub>1</sub>, e<sub>2</sub>) Preliminary evaporation; f) Vacuum/cooling crystallization (Chemietechnik Messo system); g) Preheater; h) Vapor condenser; i) Vacuum pump; j) Hydrocyclone; k) Centrifuge; l) Centrifuge liquor tank; m) Filter for mother liquor; n) Mother liquor tank; o) Drying or calcining rotary kiln; p) Cooling device for calcined  $K_2CO_3$ ; q) Storage for hydrated potash; r) Storage for calcined potash.

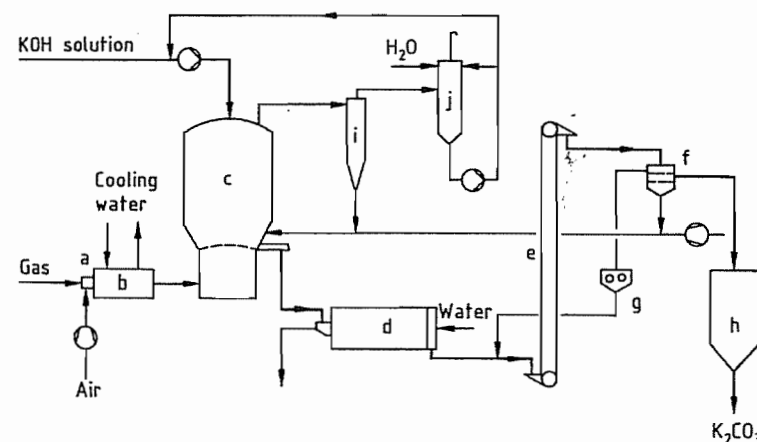
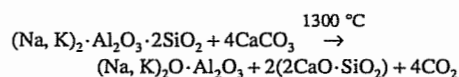

Figure 52.45: Production of potassium carbonate by the fluidized-bed process: a) Burner; b) Gas cooler; c) Fluidized-bed reactor; d) Cooler; e) Elevator; f) Screen; g) Mill; h) Silo; i) Cyclone; j) Exhaust gas scrubber.

The use of triethylamine [288], hexamethylenimine [289], or piperidine [290] is also patented. All the processes have the disadvantage that calcium chloride liquor is obtained, which can be utilized today only to a small extent and therefore represents an environmental pollutant.

**Nepheline Decomposition Process** [291]. In the CIS, considerable amounts of potassium carbonate are formed as a by-product in the nepheline decomposition process for aluminum hydroxide production. The mineral nepheline is decomposed with limestone by sintering at 1300 °C:



Alumina, portland cement, soda, and potash are obtained from the product in a complex process. The sinter product is leached with an  $\text{Na}_2\text{CO}_3$ -NaOH solution. After filtration, a filter cake is obtained that is processed to give portland cement and an aluminate solution containing silicic acid. After precipitation of the silicic acid as alkaline aluminum silicate the purified aluminate solution is reacted with carbon dioxide:

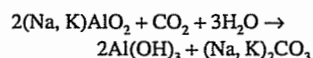

The aluminum oxide hydrate is filtered off, and the carbonate solution is concentrated by fractional crystallization in a three-stage process and separated into sodium carbonate and  $\text{K}_2\text{CO}_3 \cdot 1.5\text{H}_2\text{O}$ .

Feldspar ( $\text{KAlSi}_3\text{O}_8$ ) and leucite ( $\text{KAlSi}_2\text{O}_6$ ) can also be decomposed analogously and used for alumina, cement, and potassium carbonate manufacture [292].

The magnesia process (Engel-Precht process) is of limited interest:

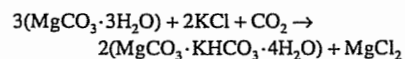

In hot water the double salt ( $\text{MgCO}_3 \cdot \text{KHCO}_3 \cdot 4\text{H}_2\text{O}$ ) decomposes under pressure into magnesium carbonate and dissolved potassium carbonate.

**Other processes.** Le Blanc process:

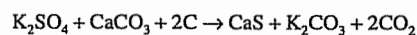

Formate process:

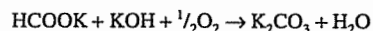

"Piesteritz" process:

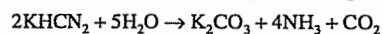
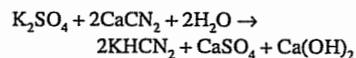

These processes are uneconomical today because of high energy consumption and poor product quality, and are no longer used.

In the decomposition of chromium ores with potassium hydroxide solution, a chromate-containing potassium carbonate is obtained as by-product. The production of potassium permanganate yields considerable amounts of potassium carbonate solution [293].

Organic raw materials, such as sunflower stalks, molasses, and suint, are used to a small extent for potash manufacture. They are ashed, leached with water, and processed to potash by fractional crystallization and calcination [294].

**Ion-Exchange Process** [295, 296]. An acidic ion exchanger loaded with ammonium ions is charged with KCl solution,  $\text{K}^+$  being absorbed and an ammonium chloride solution running off. The ion exchanger is then eluted with an excess of ammonium carbonate solution (regeneration of the exchanger). The eluate, a  $\text{K}_2\text{CO}_3$ - $(\text{NH}_4)_2\text{CO}_3$  solution, is separated by thermal cleavage to give ammonia and carbon dioxide. The ammonium chloride is reacted with magnesium hydroxide to give magnesium chloride and ammonia, which is recycled.

### 52.14.3 Quality Specifications and Analysis

Depending on the intended use, potassium carbonate is offered in varying commercial forms and degrees of purity: as granules, as powder, and as potassium carbonate hydrate ( $\text{K}_2\text{CO}_3 \cdot 1.5\text{H}_2\text{O}$ ). The material manufactured from mercury-process potassium hydroxide

solution is of high purity, particularly with respect to chloride content. In the amine process, the chloride content is higher and the sodium carbonate content lower, while nepheline decomposition gives high sodium carbonate contents and relatively high sulfate contents (Table 52.12).

**Analysis.** The *total alkalinity* includes  $\text{K}_2\text{CO}_3 + \text{KOH} + \text{Na}_2\text{CO}_3$ ; it is determined with 0.5  $\text{NH}_2\text{SO}_4$  by potentiometric titration or with a methyl orange indicator (change to brown-red). Sodium is determined by flame photometry. The *chloride content* is determined by turbidity measurement after addition of  $\text{AgNO}_3$ . The *sulfate content* is determined by ion chromatography or gravimetrically after precipitation as barium sulfate. The *metal content* is determined by atomic absorption spectroscopy or photometrically by complex formation ( $\text{Fe}^{2+}$  as sulfosalicylate,  $\text{Si}^{4+}$  as the molybdate complex,  $\text{Cu}^{2+}$  as pyrrolidinothiocarbamate, and  $\text{Ni}^{2+}$  as the diacetylgyloxime complex). Test methods for *photographic-grade* potassium carbonate, anhydrous are described in ISO 3623-1976 (E).

### 52.14.4 Storage and Transportation

Potassium carbonate is stored in bunkers; the ventilation air must be dry because of the hygroscopicity of the product.

Silo vehicles and bulk containers are used for dispatch to bulk customers. Smaller amounts are packed in polyethylene valve sacks of 25–50 kg. The material is not hazardous; for pharmaceutical use it is classified as GRAS (generally recognized as safe) by FDA [297].

Table 52.12: Analyses of calcined potassium carbonate of varying origin (data in %, remainder  $\text{H}_2\text{O}$ ).

|                          | From potassium hydroxide solution |               |                   |               | Nepheline decomposition |
|--------------------------|-----------------------------------|---------------|-------------------|---------------|-------------------------|
|                          | Mercury process                   |               | Diaphragm process | Amine process |                         |
|                          | Crystallization                   | Fluidized bed |                   |               |                         |
| $\text{K}_2\text{CO}_3$  | 98.0–99.8                         | 98.5–99.5     | 97–99             | 99            | 97.5–98.5               |
| $\text{Na}_2\text{CO}_3$ | 0.1–0.5                           | 0.1–0.5       | 0.5–1.0           | 0.01          | 0.1–1.0                 |
| Cl                       | 0.001–0.002                       | 0.004–0.013   | 0.2–1.0           | 0.19          | 0.01–0.03               |
| $\text{SO}_4$            | 0.003–0.005                       | 0.005–0.013   | 0.005–0.010       |               | 0.25–0.60               |
| Si + Ca                  | 0.005                             | 0.006         | 0.010             | 0.009         |                         |
| Fe                       | 0.0003–0.0005                     | 0.0002–0.0006 | < 0.0005          | < 0.0024      | 0.0007–0.0021           |

## 52.15 Potassium Hydrogencarbonate [273–275]

### 52.15.1 Properties and Production

Potassium hydrogencarbonate  $\text{KHCO}_3$ ,  $\rho$  2.17  $\text{g/cm}^3$ , is a white, crystalline powder that is sparingly soluble in water and insoluble in alcohol. When heated above 120 °C, it decomposes into potassium carbonate, water, and carbon dioxide.

It is manufactured industrially by passing carbon dioxide into concentrated potassium carbonate solutions or exposing these to a countercurrent of purified, cold flue gas in trickle towers (overcarbonization). Because of its low water solubility (22.4 g of  $\text{KHCO}_3$  in 100 mL of  $\text{H}_2\text{O}$  at 20 °C) it precipitates in crystalline form, is separated by centrifugation, and dried at ca. 110 °C. In some potassium carbonate production processes, potassium hydrogencarbonate is obtained as a precursor.

The total alkalinity of the industrial material, calculated as  $\text{KHCO}_3$ , is at least 98–100% [ $\text{KHCO}_3$  98% (min.),  $\text{Na}^+$  0.1% (max.),  $\text{Cl}^-$  0.01% (max.),  $\text{SO}_4^{2-}$  0.02% (max.); for analysis see potassium carbonate, Section 52.14.2].

### 52.15.2 Uses

Potassium hydrogencarbonate is used in the manufacture of fire extinguisher powders, in the food industry as a leavening agent, and in the chemical and pharmaceutical industry for the manufacture of high-purity potassium carbonate and other pure potassium salts. Producing countries are the United States, Germany, and France.

## 52.16 Potassium Benzoate

At 17.5 °C, a saturated aqueous solution of  $\text{C}_7\text{H}_5\text{O}_2\text{K}$  contains 41.1% of the salt. Potassium benzoate is a key compound in the production of terephthalic acid from benzoic acid.

## 52.17 Storage and Transportation

The demand for potash fertilizers fluctuates greatly throughout the year, but because potash plants need to produce at as steady a rate as possible, large storage capacities are needed to accommodate periods of low demand. Therefore, potash plants usually have high-capacity product storage facilities. Also, in seaports, where fertilizers are loaded onto ships, the largest potash companies or their subsidiaries have large storage capacities. In both cases, long storage sheds are used, usually with walls sloping to match the angle of repose of the potash salt. The sheds are usually filled by means of conveyor belts located under the shed roof. They are emptied either by bucket loaders or scrapers that move the salt into a channel under the floor of the silo or onto a conveyor belt at the side, which carries it via sloping bands or elevators to the loading plant. More recently, especially where there is a shortage of land, round silos have been used, often arranged in rows. These too are filled from above by conveyor belts and are emptied through openings at ground level. The majority of potash fertilizer is transported in bulk in self-discharging wagons with a capacity up to 100 t, by rail, truck, or inland waterway. Transport from potash plants remote from a seaport or the main consuming area is usually by special trains that run on a fixed timetable between the potash plant and the seaport or intermediate storage facility. For example, the transport of potash fertilizers from Saskatchewan to a cargo-handling plant in Vancouver uses continuous-loop train tracks that enable 10 000 t to be delivered in 102 wagons with a capacity of 98 t each [270].

A small proportion of potash salts is supplied in sacks, usually containing 50 kg. The sacks are filled either by the supplier or at the loading plant at the seaport by automatic sack-filling machines. The sacks are usually palletized.

## 52.18 Analysis of Potassium Compounds

Potassium is usually determined gravimetrically. In the United States, it is precipitated as the hexachloroplatinate [271]. Precipitation as the tetraphenylborate is another widely used method, being the standard ISO method for fertilizers, and can be either a gravimetric or a volumetric procedure (ISO 5318 and 5310) [272]. Precipitation as the perchlorate or tartrate is seldom used. Flame photometry is used for both laboratory and process control analysis. Recently, X-ray fluorescence has also been used for the analysis of solids or brines.

## 52.19 References

- J. W. Mellor, *Supplement III to Mellor's Comprehensive Treatise on Inorganic and Theoretical Chemistry*, Vol. II, John Wiley & Sons, Inc., New York 1963.
- O. J. Foust (ed.): *Sodium and Sodium-Potassium Engineering Handbook*, Vol. I, Gordon and Breach, New York 1972, Chap. 2.
- Landolt-Börnstein* (1965) 4, 2C, 351.
- Winnacker-Küchler*, 4th ed., 6 (1973) p. 102.  
R. Thilenius, *Z. Elektrochem.* 37 (1931) p. 740.
- Mine Safety Appliances Company, US 2480655, 1949 (C. B. Jackson, R. C. Werner).
- Fed. Reg.* 55 (1990) Dec. 21, 52402–52729; 56 (1991) Dec. 20, 66124–66287; 59 (1994) Dec. 29, 67390–67556.
- R. E. Lee and S. L. Walter, *Techniques of Sampling and Analyzing Hot Flowing Sodium-Potassium Alloy TR-4*, MSA Research Corp., Evans City, PA, 1950.  
J. W. Mausteller, F. Tepper, and S. J. Rodgers, *Alkali Metal Handling and Systems Operating Techniques*, Gordon and Breach Scientific Publishers, Inc., New York 1967.
- M. A. Armour, L. M. Browne and G. L. Weir, *Hazardous Chemical Information and Disposal Guide*, 2nd Edition, Univ. of Alberta, Edmonton, Alberta, 1984, p. 202.
- A. A. Morton, *Solid Organoalkali Metal Reagents*, Gordon & Breach, New York 1964.
- H. Pines, W. M. Stalick, H. B. Injovanovich (eds.), *Base-Catalyzed Reactions of Hydrocarbons and Related Compounds*, Academic Press, New York 1977.
- M. Szwarc, *Carbanions, Living Polymers, and Electron Transfer Processes*, Interscience, New York 1968.
- E. Grovenstein, Jr., K. W. Chiu, B. B. Patil, *J. Am. Chem. Soc.* 102 (1980) p. 5848.  
E. Grovenstein, *Adv. Organomet. Chem.* 16 (1977) p. 167.
- L. Lochmann, J. Pospisil, D. Lim, *Tetrahedron Lett.* 7 (1966) pp. 257–262.
- L. Lochmann, J. Petranek, *Tetrahedron Lett.* 32 (1991) p. 1483.
- L. Lochmann, J. Trekoval, *J. Organomet. Chem.* 326 (1987) pp. 1–7.
- M. Schlosser, S. Strank, *Tetrahedron Lett.* 25 (1984) pp. 741–744.
- Chem. Eng. News* 33 (1955) p. 648.
- M. A. Turchin et al., *Appl. Therm. Sci.* 1 (1988) no. 1, pp. 39–43.
- W. G. Anderson et al., *Proc. 25th Intersoc. Energy Convers. Eng. Conf.* 25 (1990) no. 5, pp. 268–273.
- R. N. Lyon (ed.), *Liquid-Metals Handbook*, 2nd ed., U.S. Government Printing Office, Washington, DC, 1952, p. 5.
- D. A. Wallace et al., *Proc. Intersoc. Energy Convers. Eng. Conf.* 26th (1991) no. 5, pp. 349–354.
- W. Mialki, *Metall (Berlin)* 3 (1959) p. 174.
- US 4929783, 1990 (R. S. Smith).
- US 4720601, 1989 (G. S. Osaka, M. F. Shiga).
- EP-A 211448, 1987 (G. Suzukamo, M. Fukao, M. Minobe, A. Sakamoto).
- GB 820263, 1959 (Z. Karl).
- C. W. Carlson, R. West, *Organometallics*, 2 (1983) no. 12, pp. 1972–1977.
- P. A. Bianconi, T. W. Weidman, *J. Am. Chem. Soc.* 110 (1988) no. 7, pp. 2342–2344.
- H. Y. Qui, Z. D. Du, *Goaeng Xucxiao Huaxue Xuebao* 10 (1989) no. 4, pp. 423–425.
- US 4800221, 1989 (O. W. Marko).
- R. D. Rieke, *Acc. Chem. Res.* 10 (1988) p. 301.
- R. M. Schramm, C. E. Langlois, *Prepr. Div. Petr. Chem. Am. Chem. Soc.* 4 (1959) no. 4, p. B-53.
- PCT Int. Appl., WO 8607097, 1986 (W. R. B. Martin).
- T. Ohsawa, T. Takagaki, A. Haneda, T. Oishi, *Tetrahedron Lett.* 22 (1981) no. 27, pp. 2583–2586.
- T. Ohsawa et al., *Chem. Phar. Bull.* 30 (1982) no. 9, pp. 3178–3186.
- C. A. Ogle, T. E. Wilson, J. A. Stowe, *Synthesis* 1989, no. 6, pp. 495–496.
- T. A. Thornton et al., *J. Am. Chem. Soc.* 111 (1989) no. 7, pp. 2434–2440.
- Jpn. Kokai Tokyo Koho, JP 63218705, 1988 (M. Ohata et al.).
- Thomas Hedley & Co., Ltd., GB 785147, 1957.
- D. Kazimierz, *Pluszcze i Srodki Piorace* 5 (1961) pp. 143–149.
- DD 235184, 1986 (G. Houbelein, D. Stadermann, H. Hartung, W. Muller).
- For a review of KTB chemistry: D. E. Pearson, C. A. Buehler, *Chem. Rev.* 72 (1974) pp. 45–86.
- L. Lochmann, H. Jakubuv, L. Brandsma, *Collect. Czech. Chem. Commun.* 58 (1993) pp. 1445–1451.
- US 5025096, 1991 (K. W. Chiu, L. C. Yu, J. R. Strickler).
- J. Tsuji, I. Minami, I. Shimizu, *Tetrahedron Lett.* 24 (1983), p. 1973.
- G. M. Coppola, *Synth. Common.* 15 (1985) p. 135.  
P. J. Dunn, R. Haner, H. Rapoport, *J. Org. Chem.* 55 (1990) pp. 5017–5025.
- E. J. Corey, M. M. Mehrotra, *Tetrahedron Lett.* 27 (1986) p. 5173.

48. W. C. Still, V. J. Novack, *J. Am. Chem. Soc.* **103** (1982) p. 1282.
49. A. B. Smith, et al., *J. Am. Chem. Soc.* **104** (1982) p. 4105.  
J. Kallmerter, T. J. Gould, *J. Org. Chem.* **51** (1986) p. 1155.
50. Y. Ikeda, H. Yamamoto, *Tetrahedron Lett.* **25**, 1984, p. 5581.  
Y. Ikeda, J. Ukai, N. Ikeda, H. Yamamoto, *Tetrahedron Lett.* **25**, 1984, p. 5177.
51. Pfizer, EP 0076643, 1982 (P. Weeks).
52. D. Heissler, J. Riehl, *Tetrahedron Lett.* **21** (1980) p. 4707.
53. K. Takeda et al., *J. Org. Chem.* **51** (1986) p. 4735.
54. D. Home, J. Gaudino, W. J. Thompson, *Tetrahedron Lett.* **25** (1984) p. 3529.
55. T. Tekahashi, S. Hashiguchi, K. Kasuga, J. Tsuji, *J. Am. Chem. Soc.* **100** (1978) p. 7424.
56. S. Hanessian, A. Ugolini, P. J. Hodges, D. Dube, *Tetrahedron Lett.* **27** (1986) p. 2699.
57. C. Heathcock, J. A. Stafford, *J. Org. Chem.* **57** (1992), p. 2566.
58. C. Almonsa, A. Moyano, M. A. Pericas, F. Serratosa, *Synthesis* 1988, p. 707.
59. J. H. Wotiz, P. M. Barelski, D. F. Koster, *J. Org. Chem.* **38** (1973) p. 489.
60. C. A. Brown, A. Yamashita, *J. Am. Chem. Soc.* **97** (1975) p. 891.  
US 5062998, Nov. 5, 1991 (F. L. Herman, A. C. L. Savoca, M. L. Listermann).
61. R. Csuk, B. I. Glanzer, A. Furstner, *Adv. Organomet. Chem.* **28** (1988) p. 85.
62. H. Kamimura, *Synth. Met.* **23** (1988) pp. 171–174.  
W. Rudorff in H. J. Emeleus, A. G. Sharpe (eds.), *Graphite Intercalation Compounds, Advances in Inorganic Chemistry and Radiochemistry*, Vol. 1, Academic Press, New York 1959, pp. 224–264.  
G. R. Henning in F. A. Cotton (ed.), *Interstitial Compounds of Graphite, Progress in Inorganic Chemistry*, Vol. 1, Interscience, New York 1959, pp. 125–205.
63. W. Uhlig, *Z. Naturforsch. B: Chem. Sci.* **50** (1995) pp. 1674–1678.  
B. Lacave-Goffin, L. Hevesi, J. Devaux, *J. Chem. Soc. Chem. Commun.* **7** (1995) pp. 769–770.
64. Y. Zhang, S. Liao, Y. Xu, *J. Mol. Cat.* **84** (1993) pp. 211–221.
65. C. A. Brown, *J. Org. Chem.* **39** (1974) p. 3913.
66. C. A. Brown, *Synthesis* **1975**, p. 326.
67. H. W. Pinnick, *Org. Prep. Proced. Int.* **15** (1983) p. 199.
68. H. C. Brown et al., *J. Org. Chem.* **49** (1984) p. 885–892.  
H. C. Brown et al., *Inorg. Chem.* **23** (1984) p. 2929–2931.
69. S. Krishnamurthy, *Aldrichimica Acta* **7** (1974) p. 55.  
C. A. Brown, *J. Am. Chem. Soc.* **95** (1973) p. 4100.
70. US 5428159, June 27, 1995 (W. C. Shieh, J. A. Carlson).
71. S. Krishnamurthy, W. B. Vreeland, *Heterocycles* **18** (1982) pp. 265–270.
72. J. M. Fortunato, B. Ganem, *J. Org. Chem.* **41** (1976) pp. 2194–2200.  
B. Ganem, *J. Org. Chem.* **40** (1975) p. 146.
73. J. A. Gladysz, *Aldrichimica Acta* **12** (1979) pp. 13–17.
74. J. W. Mausteller in M. L. Nuckols, K. A. Smith (eds.): *Charact. Carbon Dioxide Absorbing Agents Life Support Equip., Winter Annu. Meet. Am. Soc. Mech. Eng.* **1982**, pp. 23–31.  
CA 98:68148.
75. D. T. Sawyer, J. S. Valentine, *Acc. Chem. Res.* **14** (1981) no. 12, p. 393.  
E. Lee-Ruff, *Chem. Soc. Rev.* **6** (1977) p. 195.  
L. Sotirion, W. Lee, R. W. Giese, *J. Org. Chem.* **55** (1990) pp. 2159–2164.
76. T. Itoh, K. Nagata, M. Okada, A. Ohsawa, *Tetrahedron Lett.* **31** (1990) p. 7193.
77. R. A. Johnson, E. G. Nidy, L. Baczynski, R. R. Gorman, *J. Am. Chem. Soc.* **99** (1977) p. 7738.  
N. A. Porter, J. D. Byers, R. C. Mebane, D. W. Gilmore, J. R. Nixon, *J. Org. Chem.* **43** (1978) p. 2088.
78. Y. H. Kim, K. S. Kim, H. K. Lee, *Tetrahedron Lett.* **30** (1989) no. 46, pp. 6357–6360.
79. C. Betancor, C. G. Francisco, R. Freire, E. Suarez, *J. Chem. Soc., Chem. Commun.* **1988**, p. 947.
80. Fertilizer Manual, International Fertilizer Development Center, Muscle Shoals, AL, 1979, pp. 225–247.
81. *Kirk-Othmer*, 3rd ed., **18**, 920–950.
82. *Winnacker-Küchler*, 4th ed., **2**, 268–333.
83. The British Sulphur Corporation, *World Survey of Potash Resources*, London 1985.
84. V. A. Zandon in N. L. Weiss (ed.): *SME Mineral Processing Handbook*, Society of Mining Engineers, New York 1985, section 22.
85. R. M. McKerchel (ed.): "Potash Technology", *1st International Potash Technology Conference*, Saskatchewan, Canada, Oct. 3–5, 1983, Pergamon Press, Toronto 1983.
86. W. H. Eatock: "Potash Refining in Saskatchewan", *Min. Eng. (Littleton, CO)* **34**, (1982) no. 9, 1350–1353.
87. M. P. Kurtanek: "Mining and Beneficiating Potash, Recent Developments and Trends outside North America", *Phosphorus Potassium* **128** (1983) Nov./Dec., 26–31.
88. *Gmelin*, System no. 22.
89. F. Serowy: *Verarbeitungsmethoden der Kalisalzsalze*, W. Knapp, Halle/Saale 1952.
90. H. Schubert: *Aufbereitung fester mineralischer Rohstoffe*, VEB Deutscher Verlag für Grundstoffindustrie, Leipzig, vol. I, 1968; vol. II, 1986; vol. III, 1984.
91. D. Fulda et al.: *Kali, das bunte, bittere Salz*, VEB Deutscher Verlag für Grundstoffindustrie, Leipzig 1990.
92. A. Heinz, R. v. d. Osten (eds.): *ABC Kali und Steinsalz*, VEB Deutscher Verlag für Grundstoffindustrie, Leipzig 1982.
93. I. Barin: *Thermochemical Data of Pure Substances*, VCH, Weinheim 1989.
94. M. Broul, J. Nývlt, O. Söhnel: *Solubility in Inorganic Two-component Systems*, Elsevier, Amsterdam 1981.
95. *Ullmann*, 4th ed., **13**, 447–496.
96. R. Slotta: "Die Kali- und Steinsalzindustrie", *Technische Denkmäler in der Bundesrepublik Deutschland*, vol. 3, Deutsches Bergbaumuseum, Bochum 1980.
97. D. Hoffmann: *Elf Jahrzehnte Deutscher Kalisalzbergbau*, Verlag Glückauf, Essen 1972.
98. Kaliverein e.V.: *Die Kaliindustrie in der Bundesrepublik Deutschland*, 6th ed., 1988.
99. *Phosphorus Potassium* **166** (1990) March/April, 17–19.
100. R. Weissenberger: *Chronique des mines de potasse d'Alsace*, Ziegler, Bergholtz 1985.
101. *Phosphorus Potassium* **168** (1990) July/Aug., 12–13.
102. J. W. Turrentine: *Potash in North America*, Reinhold Publ., New York 1943.
103. *Phosphorus Potassium* **68** (1973) Nov./Dec., 39–43.
104. O. Braitsch: *Entstehung und Stoffbestand der Salzlagerstätten*, Springer Verlag, Berlin 1962.
105. In [94], p. 450.
106. M. A. Zharkov: *Paleozoic Salt Bearing Formations of the World*, Springer Verlag, Berlin 1984.
107. E. A. Vysotsky, V. Z. Kislik: "Epochs of Bischofite Deposition in Geological History", *Int. Geol. Rev.* **29** (1987) no. 2, 134–139.
108. R. Kühn, *Kali Steinsalz* **1** (1955) no. 9, 3–16.
109. R. Kühn, *Geol. Jahrb.* **90** (1972) 127–220.
110. H. Borchert: *Ozeane Salzlagerstätten*, Bornträger, Berlin 1959.
111. F. Lotze: "Steinsalz und Kalisalze", *Die wichtigsten Lagerstätten der „Nicht-Erze“*, vol. III, part 1, Bornträger, Berlin 1938.
112. F. Lotze: *Steinsalz und Kalisalze*, 2nd ed., part 1, Bornträger, Berlin 1957.
113. F. Lotze: *Die Salzlagerstätten in Zeit und Raum*, Arbeitsgem. Forsch. Landes Nordrhein-Westfalen, no. 195, Westdeutscher Verlag, Köln-Opladen 1969.
114. G. Richter-Bernburg: "Salzlagerstätten", in Bentz-Martini (ed.): *Lehrbuch der Angewandten Geologie*, vol. 2, part 1, Enke Verlag, Stuttgart 1968, pp. 916–1061.
115. G. Richter-Bernburg, *Z. Dtsch. Geol. Ges.* **105** (1953) 593–645.
116. M. Brongersma, *Mar. Geol.* **11** (1972) 123–144.
117. C. Kippenberger et al.: *Untersuchungen über Angebot und Nachfrage mineralischer Rohstoffe, XX Kali*, BGR Hannover-DIW Berlin, Schweizerbart, Stuttgart 1986.
118. J. D'Ans, *Naturwissenschaften* **34** (1947) 295–301.
119. J. D'Ans, R. Kühn, *Kali Steinsalz* **3** (1960) 69–84.
120. H. Mayrhofer: "World Reserves of Mineable Potash Salts Based on Structural Analysis", *Proceedings of the 6th International Symposium on Salt*, vol. 1, The Salt Institute, Alexandria, USA, 1983.
121. P. A. Ziegler, *Geological Atlas of Western and Central Europe*, Elsevier, Amsterdam 1982.
122. E. Messer, *Kali Steinsalz* **5** (1970) 244–251.
123. Pittsburgh Plate Glass Co., US 3058729, 1962 (J. B. Dahms, B. P. Edmonds); CA 627308, 1963 (J. B. Dahms); US 4007964, 1977 (E. L. Goldsmith); US 3262741, 1966 (B. P. Edmonds, J. B. Dahms); US 3433530, 1969 (J. B. Dahms, B. P. Edmonds); US 4329287, 1980 (F. L. Goldsmith).
124. *Phosphorus Potassium* **138** (1985) July/Aug., 32–33.
125. D. Jackson, *Eng. Min. J.* **174** (1973) no. 7, 59–68.

126. G. Duchrow, I. Fitz, N. Grischow, *Phosphorus Potassium* **167** (1990) May/June, 26–32.
127. H. Schubert in [90], vol. 1, 72–84.
128. R. Kühn, *Kali Steinsalz* **5** (1970) 307–317.
129. R. Kühn, *Erzmetall* **8** (1955) Suppl. B93–B107, B115.
130. H. Autenrieth, O. Braun, W. Otto in [81], 281–283.
131. V. A. Zandon in [83], 22–4–22–5.
132. J. Gotte, *Kali Steinsalz* **10** (1990) 261–264.
133. J. H. van't Hoff: *Untersuchungen über die Bildungsverhältnisse der ozeanischen Salzlagerungen*, Akad. Verlagsges., Leipzig 1912.
134. H. D'Ans: *Die Lösungs-gleichgewichte der Systeme der Salze ozeanischer Salzlagerungen*, Verlagsges. für Ackerbau, Berlin 1933.
135. J. F'Ans, *Z. Elektrochem.* **56** (1952) 497–505.
136. *Gmelin*, System no. 22.
137. A. B. Sdanowsky, E. I. Lyakhowskaya, R. E. Schlyemowitch: *Handbuch der Löslichkeit der Salzsyste-me*, Gaskhimisdat, Leningrad, vol. I, 1953; vol. II, 1954; vol. III, 1961; vol. IV, 1963 (Russ.).
138. H. Autenrieth, *Kali Steinsalz* **1** (1953) no. 2, 3–17.
139. H. Autenrieth, *Kali Steinsalz* **1** (1954) no. 7, 3–22.
140. H. Autenrieth, *Kali Steinsalz* **1** (1955) no. 11, 18–32.
141. H. Autenrieth, *Kali Steinsalz* **2** (1958) no. 6, 181–200.
142. H. Autenrieth, *Kali Steinsalz* **5** (1969) no. 5, 158–165.
143. H. Autenrieth, *Rev. chim. minér.* **7** (1970) 217–229.
144. H. Autenrieth, *Kali Steinsalz* **5** (1970) no. 9, 289–306.
145. G. Peuschel, *Kali Steinsalz* **9** (1986) no. 9, 296–303.
146. W. P. Wilson, A. G. McKee: *Proceedings of the 4th Symposium on Salt*, vol. 1, The Northern Ohio Geological Society, Cleveland, OH, 1974, 517–525.
147. W. P. Wilson: *Proceedings of the 3rd Symposium on Salt*, vol. II, The Northern Ohio Geological Society, Cleveland, OH, 1969, 20–29.
148. J. H. Wolf in [84], 711–716.
149. H. Domning, *Kali Steinsalz* **7** (1977) no. 4, 155–160.
150. W. H. Coghill, J. R. De Vancy, J. B. Clemmer, S. R. B. Cooke, Report of Investigations of the U.S. Bureau of Mines, Report no. 3271, 1935.
151. A. S. Kusun, *Kalilii* **6** (1937) 17–27.
152. R. A. Pierce, L. D. Anderson, *Eng. Min. J.* **143** (1942) 38–41.
153. Kreller, *Kali, Verw. Salz Erdöl* **33** (1939) 35–37, 46–47, 53–57.
154. E. Rusberg, *Chem.-Ing.-Tech.* **27** (1955) 1–4.
155. O. Karsten, in W. Gründer: *Erzaufbereitungsanlagen in Westdeutschland*, Springer Verlag, Berlin 1955, 343–345.
156. V. A. Arscntiev, J. Leja, *CIM Bull.* **3** (1977) 154–158.
157. Du Pont, US 2088325, 1937 (J. F. Kirby).
158. C. M. Aleksandrovic, *Freiberg. Forschungsh.* **A544** (1975) 73–81.
159. H. Schubert, *Aufbereit. Tech.* **7** (1967) 365–368.
160. A. Singewald, *Chem.-Ing.-Tech.* **33** (1961) 376–393, 558–572, 676–688.

161. D. W. u. M. C. Fuerstenau, *Min. Eng. (Littleton, CO)* 8 (1956) 302-307.
162. A. F. Taggart, *Elements of Ore Dressing*, John Wiley & Sons, New York 1951.
163. A. M. Goudin, Testimony in Transcript of Evidence, Civil Action no. 1829, District of New Mexico, p. 1255.
164. R. Bachmann, *Erzmetall* 8 (1955) Suppl. B109-B116.
165. J. Rogers, J. H. Schulman: *Second International Congress of Surface Activity*, vol. II, Reprints, Butterworths, London 1957, 330-338.
166. A. Singewald, *Erzmetall* 12 (1959) 121-135.
167. O. J. Somojlov: *Struktur von wäßrigen Elektrolytlösungen*, B. G. Teubner, Leipzig 1961.
168. H. Schubert, *Aufbereit. Tech.* 6 (1966) 305-313.
169. F. Hagedorn, *Kali Steinsalz* 10 (1991) 315-328.
170. D. Uhlig, *Neue Bergbautech.* 5 (1975) 145-155.
171. H. Köhler et al., *Neue Bergbautech.* 16 (1986) 45-50.
172. N. F. Mescerjakov, Y. W. Rjabov, V. N. Kuznetsov, *Freiberg. Forschungsh.* A594 (1978) 33-54.
173. A. Bahr, K. Legner, H. Lüdke, F. W. Mehrhoff, *Aufbereit.-Tech.* 1 (1957) 1-9.
174. N. F. Mescerjakov: *Flotacionnye mashiny*, Isdatel'stvo Nedra, Moskva 1972.
175. H. Schubert, *Neue Bergbautech.* 4 (1974) 223-228.
176. *Phosphorus Potassium* 145 (1986) 29-33.
177. Kali & Salz, DE 3435124, 1987 (F. Hagedorn, G. Peuschel, A. Singewald).
178. F. Hagedorn, *Kali Steinsalz* 9 (1986) 232-238.
179. H. Köhler, W. Kramer, *Neue Bergbautech.* 11 (1981) 362-366.
180. R. B. Tippin, *Chem. Eng. (N.Y.)* 184 (1977) no. 15, part 1, 73-75.
181. VEB Kali, DD 220237, (L. Herrmann et al.).
182. S. Mildner, R. Ecke, DD 35637, 1965.
183. I. M. Le Baron, W. C. Knopf, *Min. Eng. (Littleton, CO)* 10 (1958) 1081-1083.
184. H. Autenrieth, *Kali Steinsalz* 5 (1969) 171-177.
185. Kali-Forschungsanstalt, DE 1056551, 1957 (H. Autenrieth).
186. G. Fricke, *Kali Steinsalz* 9 (1986) 287-295.
187. D. Larmour in [84], 597-602.
188. R. Bock, *Chem.-Ing.-Tech.* 53 (1981) 916-924.
189. Kali & Salz, DE 1249783, 1966 (A. Singewald, G. Fricke).
190. A. Singewald, U. Neitzel in [84], 589-595.
191. L. Ernst, *Kali Steinsalz* 9 (1986) 275-286.
192. L. Ernst, *Ber. Bunsenges. Phys. Chem.* 93 (1989) 857-863.
193. L. Ernst, *Ber. Bunsenges. Phys. Chem.* 94 (1990) 1435-1439.
194. Kali & Salz, DE 3603166, 1986 (G. Fricke, I. Giesler, R. Diekmann).
195. Kali & Salz, DE 3603165, 1986 (H. Balzer, H. Burghardt, F. Maikranz).
196. Kali & Salz, DE 3603167, 1986 (U. Neitzel, G. Fricke).
197. Kali & Salz, DE 1077611, 1959 (H. Autenrieth, G. Peuschel).
198. Kali & Salz, DE 1142802, 1961 (H. Autenrieth, G. Peuschel, G. Weichart).
199. Kali & Salz, DE 2007677, 1970 (A. Singewald, G. Fricke, D. Jung).
200. Kali & Salz, DE 2052993, 1970 (A. Singewald, G. Fricke, D. Jung).
201. Kali & Salz, DE 1154052, 1960 (H. Autenrieth, H. Dust).
202. Kali & Salz, DE 1076593, 1957 (H. Autenrieth).
203. Kali & Salz, DE 1261453, 1967 (A. Singewald, G. Fricke).
204. Kali & Salz, DE 1667814, 1968 (G. Fricke, A. Singewald).
205. Kali & Salz, DE 1283772, 1967 (H. Autenrieth, H. Wirries).
206. Kali & Salz, DE 1792120, 1968 (A. Singewald, G. Fricke).
207. Kali & Salz, DE 1953534, 1969 (A. Singewald, G. Fricke).
208. W. B. Dancy in [80], 931-933.
209. T. E. Burus, B. J. Clarke, W. B. Coome, A. H. Newcombe in [84], 541-546.
210. R. Diekmann: Lecture held at *Int. Potash Technol. Conf., 2nd*, Hamburg, May 26-29, 1991.
211. E. Weps, *Kali Steinsalz* 8 (1981) 177-183.
212. Kali & Salz, DE 3434190, 1984 (O. Pfoh, C. Radick, H. Thenert).
213. F. Hagedorn, *Kali Steinsalz* 7 (1977) 161-164.
214. T. Fleischer, *Kali Steinsalz* 9 (1986) 304-313.
215. H. J. Scharf: "Environmental Aspects of K-Fertilizers in Production, Handling and Application", *Development of K-Fertilizer Recommendations*, International Potash Institute, Worblaufen-Bern 1990, 395-402.
216. *Phosphorus Potassium* 148 (1987) March/April, 30-35.
217. M. D. Haug, K. W. Reid: Lecture held at *Int. Potash Technol. Conf., 2nd*, Hamburg, May 26-29, 1991.
218. J. F. Tallin, D. E. Pufahl in [84], 755-760.
219. K. W. Reid, G. A. Maki: Lecture held at [217].
220. H. E. Schroth, *Phosphorus Potassium* 67 (1973) Sept./Oct., 38.
221. A. Singewald, *Die Weser* 57 (1983) no. 516, 1-8.
222. N. Knöpfel in [217].
223. H. Stahl, *Aufbereit. Tech.* 20 (1980) 525-533.
224. W. B. Pietsch in [84], 661-669.
225. L. Medemblik in [84], 653-659.
226. A. S. Middleton, D. A. Cormode, J. E. Scotten in [84], 647-651.
227. *Phosphorus Potassium* 173 (1991) May/June 28-36.
228. K. Kahle, G. Leib: Lecture held at [217].
229. L. I. Skvirski, A. A. Chityakov, Z. L. Kozel: Lecture held at [217].
230. H. Rieschel, K. Zech, *Phosphorus Potassium* 115 (1981) Sept./Oct., 33-39.
231. H. Rug, K. Kahle, *Phosphorus Potassium* 170 (1990) Nov./Dec., 23-27.
232. International Fertilizer Industry Association (IFA): *Potash Statistics 1989*, Paris.
233. Prognose-Arbeitsgruppe Weltbank/FAO/Unido, 1991, unpublished.
234. C. Childers, *Phosphorus Potassium* 169 (1990) Sept./Oct., 16-20.
235. O. Walterspiel, *Kali Steinsalz* 10 (1989) 168-174.
236. *Phosphorus Potassium* 165 (1990) Jan./Febr., 1819.

237. *Gmelin*, System no. 22, Suppl. vol., pp. 1280-1338.
238. J. Nather, H. H. Emons, *Bergakademie* 21 (1969) 310-313.
239. *Phosphorus Potassium* 156 (1988) July/Aug., 27-34.
240. *Phosphorus Potassium* 122 (1982) Nov./Dec., 36-39.
241. N. P. Finkelstein, S. H. Garnett, L. Kogan in [84], 571-576.
242. U. Neitzel, *Kali Steinsalz* 9 (1986) 257-261.
243. H. Autenrieth, O. Braun, W. Otto in [81], 320-322.
244. H. Scherzberg, G. Döring: Lecture held at [217].
245. Kali & Salz, DE 3418147, 1984 (E. Menche, H. G. Diehl, H. Eberle).
246. W. B. Dancy in [80], 945.
247. D. K. Storer in [84], 577-582.
248. R. Phinney, EP 0199104, 1986.
249. Kali & Salz, DE 3607641, 1986 (S. Vajna, G. Peuschel).
250. Société d'études chimiques pour l'industrie et l'agriculture (SECPIA), DE 956304, 1954 (J. Lafont).
251. J. A. Fernandez Lozano, A. Wint, *Chem. Eng. J. (Lausanne)* 23 (1982) 53-61.
252. *Phosphorus Potassium* 167 (1990) May/June, 11.
253. Superfos A/S, Vedbæk, DK, DE 3331416, 1983 (K. C. B. Knudsen); US 4504458, 1983 (K. C. B. Knudsen).
254. *Chem. Eng. (N.Y.)* 81 (1974) 98-99.
255. Kali & Salz, DE 2810640, 1978 (N. Knöpfel, F. Wartenpfehl, A. Hollstein).
256. A. Hollstein, *Kali Steinsalz* 7 (1979) 498-500.
257. *Phosphorus Potassium* 141 (1986) Jan./Feb., 17-21.
258. *Phosphorus Potassium* 151 (1987) Sept./Oct., 16-21.
259. G. Kemmler, *Kali Steinsalz* 9 (1985) 167-169.
260. In [82], pp. 62-64.
261. *Phosphorus Potassium* 24 (1966) 40-44.
262. A. M. Amarin, K. Manasrah, *Proc. IFA-NFC Joint Middle East-South Asia Fertilizer Conference*, Lahore, Pakistan, Dec. 3-6, 1988.
263. *Kirk-Othmer*, 2nd ed., Suppl. vol., 438-467.
264. In [82], pp. 38-39.
265. U. Neitzel, *Kali Steinsalz* 5 (1971) 327-334.
266. P. Behrens, Industrial Processing of Great Salt Lake Brines, *Utah Geological and Mineral Survey Bulletin* 116, 1980, 223-228.
267. *Phosphorus Potassium* 132 (1984) July/Aug., 6.
268. In [82], pp. 42-43.
269. In [82], p. 70.
270. *Phosphorus Potassium* 173 (1991) May/June, 26-27.
271. W. Horwitz (ed.): *Official Methods of Analysis of the AOAC*, 11th ed., Association of Official Analytical Chemists (AOAC), Washington, DC, 1970.
272. Verband Deutscher Landwirtschaftlicher Untersuchungs- und Forschungsanstalten (LUFA): "Die Untersuchung von Düngemitteln", *Methodenbuch*, vol. II, Verlag J. Neumann-Neudamm, Melsungen 1972, method 4.1.
273. *Kirk-Othmer*, 3rd ed., 18, 936-939.
274. J. Ford: "Caustic potash", *Encycl. Chem. Process. Des.* 7 (1978) 22-34.
275. *Ullmann*, 4th ed., 13, 489-496.
276. Hüls, Handbook KOH-, K<sub>2</sub>CO<sub>3</sub>-, KHCO<sub>3</sub>-Products, Marl 1992.
277. N. Takeuchi, *Soda to Enso* 39 (1988) no. 461, 277-290.
278. Bertrams, Concentration Plants for NaOH-, KOH-, Na<sub>2</sub>S- and CaCl<sub>2</sub>-liquors, Muttensz, Switzerland, 1979.
279. Sulzer-Escher-Wyss, US 4927494, 1990 (R. Winkler et al.).
280. Oxy-Occidental Chem. Corp., Caustic Potash Handbook, Irving 1987.
281. Oil Paint Drugs, Chemical Marketing Reporter, 28th May, 1990.
282. Messo Chemietechnik Brochure, Mass Crystallization, Duisburg, Germany, 1990.
283. Mannesmann, DE 3816061, 1989 (R. Schmitz).
284. VEB Kombinat Kali, DD 255328A, 1986 (K. Will, G. Elberling).
285. Bertrams, Fluid Bed Processes, Muttensz, Switzerland, 1979.
286. Diamond Shamrock Corp., Company brochure, Cleveland, OH, 1969.
287. *Inf. Chim.* 99 (1971) Aug./Sept., 125.
288. Kali-Chemie, DT 1220401, 1962 (P. Schmid).
289. J. N. Shokin et al., *Khim. Promst. (Moscow)* 9 (1978) 685.
290. FMC Corp., BE 616193, 1962 (A. B. Gency, M. J. McCarthy).
291. D. M. Ginzburg, A. A. Tripolskii, *Tr. Gos. Nauchno-Issled. Proekt. Inst. Osnov. Khim.* 30 (1973) 26.
292. IMC Corp., US 3073443, 1960 (R. E. Snow).
293. A. Schmidt, *Angewandte Elektrochemie*, Verlag Chemie, Weinheim 1976, p. 183.
294. Lemar Developments, AU 563487, 1987 (B. W. Levy).
295. *Chem. Age Int.*, 29th Sept., 1972.
296. Dynamit Nobel, DT 1812769, 1968 (D. Labriola et al.).
297. FDA, *Fed. Regist.* 48 (1983) no. 224, 52440-3.

# 53 Rubidium

WINFRIED LENK, HORST PRINZ

|   |      |   |      |
|---|------|---|------|
| 53.1 Introduction . . . . .                       | 2211 | 53.6 Storage and Transportation. . . . .          | 2213 |
| 53.2 Properties . . . . .                         | 2211 | 53.7 Uses and Economic Aspects. . . . .           | 2213 |
| 53.3 Raw Materials and Production . . . . .       | 2211 | 53.8 Toxicology and Occupational Health . . . . . | 2213 |
| 53.4 Inorganic Compounds . . . . .                | 2212 | 53.9 References . . . . .                         | 2214 |
| 53.5 Quality Specifications and Analysis. . . . . | 2212 |   |      |

## 53.1 Introduction

Rubidium was discovered in 1861 by BUNSEN, who found hitherto unknown spectral lines during experiments on cesium salts obtained from spa water from Bad Dürkheim, Germany. Soon after this, he succeeded in preparing rubidium metal from its tartrate.

## 53.2 Properties

Rubidium, the penultimate alkali metal element that is used in industry, is named after two characteristically colored spectral lines (Latin: *rubidus* = dark red). It is a very reactive soft metal with a silvery luster and has the typical chemical properties of an alkali metal. It ignites spontaneously in air and burns with a violet flame. It reacts explosively with water to form colorless rubidium hydroxide, the second strongest base after cesium hydroxide. Rubidium forms four oxides, all of which are colored [1]. Rubidium is monovalent in all its compounds. The isotopic composition of natural rubidium is 72.15%  $^{85}\text{Rb}$ , a stable isotope, and 27.85%  $^{87}\text{Rb}$ , a  $\beta^-$  emitter. Eighteen artificial isotopes are known. Between mass numbers 79 and 84, these are mainly  $\beta^+$  emitters, and between mass numbers 85 and 95 they are exclusively  $\beta^-$  emitters. Some important physical properties of natural elementary rubidium are:

|                      |        |
|----------------------|--------|
| Atomic number        | 37     |
| Relative atomic mass | 85.468 |
| Melting point        | 39 °C  |
| Boiling point        | 696 °C |

|                                    |   |
|------------------------------------|---|
| Ionization potential               | 4.16 eV   |
| Work function                      | 2.19 eV   |
| Normal electrode potential         | -2.99 V   |
| Electrical conductivity (at 0 °C)  | $8.86 \times 10^{-4} \Omega^{-1}\text{cm}^{-1}$ |
| Thermal conductivity (liquid)      | $29.30 \text{ Wm}^{-1}\text{K}^{-1}$            |
| Specific heat capacity             |   |
| Solid                              | 0.332 $\text{Jg}^{-1}\text{K}^{-1}$             |
| Liquid (from <i>mp</i> to 1093 °C) | 0.368   |
| Gas                                | 0.242   |
| Heat of fusion                     | 25.71 J/g                                       |
| Heat of sublimation (at 25 °C)     | 1004.3 J/g                                      |
| Heat of vaporization               | 887.6 J/g                                       |
| Vapor pressure (427–1093 °C)       | $\log(p/\text{mbar}) = 7.0493 - 3891.8 K/T$     |
| Mohs hardness                      | 0.3   |
| Atomic radius                      | 0.243 nm  |
| Covalent radius                    | 0.211 nm  |
| Ionic radius                       | 0.149 nm  |
| Density at 18 °C                   | 1.522 $\text{g/cm}^3$                           |
| at <i>mp</i> , liquid              | 1.472   |
| Crystal structure                  | body-centered cubic                             |

## 53.3 Raw Materials and Production [2–6]

Rubidium is very widely distributed and always occurs in combined form owing to its high chemical reactivity. Unlike its homologues lithium and cesium, it is not a major component of any mineral. Nevertheless, it is more abundant in the Earth's crust than lithium and cesium (ca. 120 g/t). Its ionic radius [3] is similar to that of potassium, and it is found in association mainly with this element, but also with the other alkali metals. The lithium-containing mica lepidolite has a high rubidium content (ca. 3%  $\text{Rb}_2\text{O}$ ). Also, pollucite, a cesium aluminum silicate from Bernic Lake in Canada, can contain ca. 1%  $\text{Rb}_2\text{O}$ .

Due to the similarity in their ionic radii, rubidium is always found in potash salt deposits, e.g., carnallite, sylvite, and langbeinite, which contain 10–300 g/t rubidium oxide,  $\text{Rb}_2\text{O}$ .

Rubidium is also widely distributed in very small concentrations in spring water, rivers, lakes, and seas.

Although rubidium is more abundant than lithium and cesium, it is much more difficult to extract than the other alkali metals. Owing to its very widespread distribution and consequent low concentration in ores, rubidium production is nearly always linked to the production of lithium, potassium, and cesium [7]. The process based on the fractional crystallization of carnallite is now only of historical interest. The more selective methods of recovering rubidium from potash salts (in which the quantities of rubidium are large but the concentrations are very low) are based on extraction processes using substituted benzenes as extractants [8–10]. Other techniques include the use of liquid crystals in a d.c. electric field [11], selective cation exchangers based on nitrated and sulfonated polystyrene [12–14], and inorganic cation exchangers consisting of complex salts based on hexacyanoferrates [15, 16]. Acidic  $\text{MnO}_2$  can be used in an adsorption–elution cycle to concentrate rubidium [17]. The liquid waste from the production of cesium from pollucite can also be treated to give rubidium.

Rubidium is obtained from the mixed alkali metal carbonates that are a by-product of the abandoned production of lithium from lepidolite in the United States. After precipitating the less soluble dicesium hexachlorostannate, the rubidium is precipitated as dirubidium hexachlorostannate. It is converted to rubidium chloride by pyrolysis. Rubidium carbonate is obtained by precipitating dirubidium zinc hexacyanoferrate(II) followed by thermal oxidation. In all processes, the main difficulty is separating the rubidium from the potassium and cesium.

In more recently published research work, the following processes are described: the extraction from weathered rocks by sodium chloride solution in a high-frequency electri-

cal field or with dipicrylamine and ultrasound [18], and the thermal decomposition of rubidium alum (rubidium aluminum sulfate) in the presence of calcium oxide followed by dissolution to form rubidium sulfate [19]. Another proposal is the recovery of rubidium from intermediates that arise in the production of aluminum oxide from bauxites and nephelines by means of solvent extraction with long-chain *p*-alkylphenols [20].

### 53.4 Inorganic Compounds

*Rubidium hydroxide*,  $\text{RbOH}$ , *mp*: 301 °C, solubility in water: 180 g/100 mL at 15 °C

*Rubidium carbonate*,  $\text{Rb}_2\text{CO}_3$ , *mp*: 837 °C, solubility in water: 450 g/100 mL at 20 °C

*Rubidium hydrogencarbonate*,  $\text{RbHCO}_3$ , *mp*: 175 °C (decomp.), solubility in water: 54 g/100 mL at 20 °C

*Rubidium fluoride*,  $\text{RbF}$ , *mp*: 775 °C, *bp*: 1410 °C, solubility in water: 130.6 g/100 mL at 20 °C

*Rubidium chloride*,  $\text{RbCl}$ , *mp*: 715 °C, *bp*: 1390 °C, solubility in water: 77 g/100 mL at 0 °C

*Rubidium bromide*,  $\text{RbBr}$ , *mp*: 682 °C, *bp*: 1340 °C, solubility in water: 98 g/100 mL at 5 °C

*Rubidium iodide*,  $\text{RbI}$ , *mp*: 642 °C, *bp*: 1300 °C, solubility in water: 152 g/100 mL at 17 °C

*Rubidium nitrate*,  $\text{RbNO}_3$ , *mp*: 310 °C, *bp*: ca. 1700 °C, solubility in water: 44 g/100 mL at 16 °C, solubility in water: 42 g/100 mL at 10 °C

These inorganic compounds are colorless or white, and have the properties typical of salts of alkali metals. They are mostly prepared by wet chemical reactions.

### 53.5 Quality Specifications and Analysis

Rubidium salts are marketed with purities up to > 99.5%. Rubidium metal is obtainable with purities of 99.5% and 99.8% [2].

Metallic impurities are usually determined by atomic absorption spectroscopy, and more recently with ICP (inductively coupled plasma) excitation. The elements are then detected by conventional optical detectors or by mass spectroscopy (ICP-MS). The homologous elements sodium, potassium, and cesium can be analyzed by emission spectroscopy. The analysis of rubidium metal must be preceded by reaction to give an aqueous salt solution. Anions can be determined photometrically (e.g., sulfate, phosphate) or argentometrically (chloride).

### 53.6 Storage and Transportation

Because rubidium metal is very reactive toward water, steam, ice, air, and many other gases and substances, special precautions are necessary. The metal is shipped in sealed evacuated glass ampoules, or is hermetically sealed in metal containers packed in vermiculite and enclosed in a second outer metal container. Due to its low melting point (*mp* 39 °C), melting cannot be prevented during transportation to or through hot climatic zones. Rubidium salts are hygroscopic and must be protected from moisture during storage and transport. Radioactive rubidium preparations are subject to special storage and transport regulations.

### 53.7 Uses and Economic Aspects

**Uses.** Rubidium compounds are used in psychiatry and medicine [21], in magneto-optic modulators [22], solid-state lasers [23], phosphors (rubidium aluminate) [24], Rb–C molecular sieves for hydrogen absorption [25], paper pigments [26], glass hardening by ion exchange [27], components of electrolytes for fuel cells [28], in Na–Rb zeolites for separating mixtures of hydrocarbons [29], and for density gradient centrifugation. In the early investigations of the Fischer–Tropsch synthe-

sis,  $\text{RbOH}$  was used to activate the iron catalyst [30]. Owing to its high ionic conductivity silver rubidium iodide,  $\text{RbAg}_4\text{I}_5$ , is of interest as a solid electrolyte for primary and secondary cells [31] and as an electrographic picture recording material [32].

The use of rubidium compounds to activate catalysts of various types may increase in terms of quantity. However, potassium and cesium often compete with rubidium in this application. Three types of catalyst may be distinguished. The most important group includes rubidium-activated transition metal oxide catalysts for the production of organic chemicals, e.g., the oxidation of acrolein to acrylic acid [33] or of  $\text{C}_4$  hydrocarbons to maleic anhydride [34], the ammoxidation of isobutene to methacrylonitrile [35], or the oxidation of *o*-xylene or naphthalene to phthalic anhydride [36]. The second category includes the activation of metallic catalysts, e.g., silver contact catalysts for ethylene oxide manufacture [37]. The third category comprises rubidium compounds that themselves have catalytic properties, e.g.,  $\text{Rb}_2\text{O}$  used in polyester production by polycondensation [38] and in  $\text{NH}_3$  synthesis [39], and  $\text{RbOH}$  for the dehydrocyclization of 1-hexene to form benzene [40].

**Economic Aspects.** Rubidium manufacturers do not publish production or sales figures. World consumption in 1979 was estimated to be ca. 2 tonnes [2], and has increased slightly since then. The demand for the metal is small compared to the demand for its compounds. In 1996, the price of 99.5% pure metal was \$0.70–1.00/g, and for 99.8% pure metal, \$0.80–6.00/g. Current prices for rubidium compounds (99.5%) are in the range ca. \$250–550/kg, and for > 99.5% pure compounds, \$550–750/kg.

### 53.8 Toxicology and Occupational Health

It is not possible to give a precise assessment from the small amount of available data on the toxicity of rubidium. In plasma and blood, the properties of rubidium are not dis-



similar to those of potassium, as far as can be determined from physiological investigations. The hazard potential is therefore regarded as low [41].

Rubidium metal is designated as a "flammable solid" and "dangerous when wet", and should be handled with great care under a protective gas or inert solvent.

In its compounds, the precautions and protective measures to be taken are determined by the anion. Thus, RbOH is very caustic, RbF shows the toxicity typical of the alkali metal fluorides, and RbClO<sub>4</sub> and RbNO<sub>3</sub> are oxidizing agents.

### 53.9 References

1. Kirk-Othmer, 3rd ed., 17, pp. 492-499.
2. Gmelin, 8th ed., System-no. Rubidium, 24.
3. Ullmann, 4th ed., 20, pp. 295-297.
4. C. E. Berthold: "Rubidium and Cesium - Where are they going?" *J. Met.* 14 (1962) 355-358.
5. E. G. Kuznetsova, L. A. Kulikova, A. K. Ru, *Sovrem. Khim.-Metallurg. Metody Pererab. Kompleks. Rud. Syrva, M.* 1985, 102-106; *Chem. Abstr.* 107, 25536.
6. E. Schroll, *BHM Berg Hüttenmänn. Monatsh.* 131 (1986) 110-115.
7. Li, Minqian, CN 85101989, 1986; *Chem. Abstr.* 107, 179516.
8. E. M. Kuznetsova, N. A. Kresova, G. M. Panchenkova, *Zh. Fiz. Khim.* 41 (1967) 1041-1046; *Chem. Abstr.* 67, 57665.
9. V. E. Plyushchev et al., SU 323459, 1970; *Chem. Abstr.* 79, 22004.
10. L. I. Pokrovskaja et al., *Zh. Prikl. Khim.* 50 (1977) 546-549; *Chem. Abstr.* 87, 9148.
11. V. N. Golubev, A. G. Petrov, V. N. Verkhovrov, SU 1279650, 1986; *Chem. Abstr.* 106, 140437.
12. R. Ratner, L. Kogag, D. Kohn, *J. Chromatogr.* 148 (1978) 539-544.

13. E. Kh. Ismailov, R. G. Osichkina, *Vzh. Khim. Zh.* (1988), no. 5, 56-58; *Chem. Abstr.* 110, 138080.
14. R. Ratner, J. Mittelman, D. H. Kohn, *J. Chem. Technol. Biotechnol. Chem. Technol.* 35A (1985) no. 5, 209-216; *Chem. Abstr.* 104, 112171.
15. S. A. Kolesova, V. V. Volkhin, V. V. Alikin, SU 552105, 1975; *Chem. Abstr.* 87, 137936.
16. R. M. Shklovskaya, S. M. Arkhipov, SU 1245555, 1986; *Chem. Abstr.* 105, 136478.
17. V. V. Volkhin, G. V. Leonteva, SU 295399, 1968; *Chem. Abstr.* 81, 51787.
18. Jiucheng Li, Xiaohong Li, Xian-Gan Li, CN 1037127, 1989; *Chem. Abstr.* 113, 194434.
19. S. M. Arkhipov, N. I. Kashina, SU 1546425, 1990; *Chem. Abstr.* 112, 237478.
20. A. M. Reznik, V. I. Vukin, L. G. Romanov, A. O. Baikonvova, *Trav. Chem. Int. Etude Bauxites Alumine Alum.* 17 (1982) 63-66; *Chem. Abstr.* 99, 91593.
21. H. L. Meltzer, R. R. Fieve, *Curr. Dev. Psychopharmacol.* 1 (1975) 203-242.
22. IBM, US 3527577, 1968.
23. Optical Materials Inc., US 3506584, 1966.
24. Toshiba, JA 7490689, 1973.
25. Ichiro Kato, JA 7401487, 1972.
26. Bayer, DE-OS 2148599, 1971.
27. Daini Seikosha Co., JA 7223885, 1970.
28. Leesona Corp., US 34883035, 1965.
29. Esso Research and Engineering Co., US 3674425, 1966.
30. F. Fischer, H. Tropsch, *Brennst. Chem.* 5 (1924) 201-216.
31. B. Scrosati, *J. Appl. Chem. Biotechnol.* 21 (1971) 223-228.
32. Nippon Electric, JA 7416440, 1972.
33. Standard Oil of Ohio, DE-OS 2634791, 1976.
34. Standard Oil of Ohio, US 4087444, 1976.
35. Montedison, DE-OS 2403716, 1973.
36. BASF, DE-AS 2546268, 1975.
37. Hoechst AG, DE-AS 2740480, 1977.
38. Mitsubishi Rayon, JA 7413635, 1968.
39. Chevron Research Co., US 3653831, 1968.
40. Phillips Petroleum, DE-OS 2832654, 1978.
41. U.S. Department of Health, Education and Welfare, NIOSH, Health Hazard Evaluation, Report 71-72, July 1973.

## 54 Cesium

MANFRED BICK, HORST PRINZ

|                             |      |  |      |
|-----------------------------|------|--|------|
| 54.1 Introduction           | 2215 | 54.7 Storage and Transportation          | 2217 |
| 54.2 Resources              | 2215 | 54.8 Uses                                | 2217 |
| 54.3 Production             | 2216 | 54.9 Economic Aspects                    | 2218 |
| 54.4 Compounds              | 2216 | 54.10 Toxicology and Occupational Health | 2218 |
| 54.5 Quality Specifications | 2217 | 54.11 References                         | 2218 |
| 54.6 Analysis               | 2217 |  |      |

### 54.1 Introduction

Cesium (from the Latin word *caesius*, gray blue, which characterizes the pale blue color of the emission of thermally excited cesium atoms) is a soft, gold-colored metal, which melts slightly above room temperature. Physical properties of elemental cesium are summarized below [4, 5]:

|  |  |
|--|--|
| Atomic number                                  | 55   |
| Relative atomic mass <i>A</i> <sub>r</sub>     | 132.90543  |
| Melting point <i>m</i> <sub>p</sub>            | 28.7 °C  |
| Boiling point <i>b</i> <sub>p</sub>            | 685 °C   |
| Atomic radius<br>(12-coordinate metal)         | 0.274 nm   |
| Ionic radius<br>(6-coordinate salt, empirical) | 0.165 nm   |
| Density <i>ρ</i> at 20 °C                      | 1.873 g/cm <sup>3</sup>                                |
| Specific heat, liquid                          | 0.236 Jg <sup>-1</sup> K <sup>-1</sup>                 |
| Heat of fusion                                 | 2.13 kJ/mol  |
| Heat of vaporization at 0.1 MPa                | 65.9 J/mol   |
| Ionization potential                           | 3.87 eV  |
| Standard electrode potential                   | -2.923 V   |
| Work function                                  | 1.91 eV  |
| Electrical conductivity<br>solid, 25 °C        | 4.9 × 10 <sup>4</sup> Ω <sup>-1</sup> cm <sup>-1</sup> |
| vapor, 1250 °C                                 | 2.0 × 10 <sup>2</sup>                                  |
| Vapor pressure <i>P</i> , kPa                  | log <i>P</i> = -0.2185 <i>A</i> / <i>T</i> + <i>B</i>  |

| T, K    | A       | B      |
|---------|---------|--------|
| 200-350 | 17543.0 | 6.0739 |
| 279-690 | 17070.7 | 5.8889 |

Cesium belongs to the alkali-metal group. The metal reacts with most elements, to form alloys when reacted with metals or to form typical salts when reacted with halogens. In the salts, cesium is strictly monovalent, and its chemistry is typical of an alkali metal. Because of its extremely low ionization potential, cesium is usually far more reactive than

lithium, sodium, or potassium and still pronouncedly more reactive than rubidium. When cesium is exposed to air, an explosion-like oxidation to form cesium superoxide, CsO<sub>2</sub>, occurs; contact with water results in a vigorous reaction to form cesium hydroxide and hydrogen gas, which may ignite spontaneously.

Naturally occurring cesium consists only of the stable isotope <sup>133</sup>Cs. Radioactive cesium isotopes, such as <sup>137</sup>Cs (half-life of 30.1 a), are generated in fuel rods during operation of nuclear power plants.

### 54.2 Resources

Cesium is the 40th most abundant among the elements, occurring about as frequently as germanium. Resources can be categorized into two groups. One, of no commercial importance, consists of the diffuse occurrence of the few grams of cesium per ton contained in potassium salt deposits, sedimentary rocks, and seawater [3].

The only sources of cesium of commercial importance originated during the solidification of residual melts of silicate magmas. After the initial formation of huge granite masses, the remaining melt rich in rare elements like lithium, rubidium, cesium, tantalum, niobium, beryllium, and tin then crystallized to form a type of ore body well-known under the name *pegmatite*. Under favorable conditions, which seem to have existed only in relatively few cases, these pegmatites differentiated into separate bodies.

Sodium, potassium, and rubidium formed feldspar-type minerals of considerable mutual solubility, while lithium and cesium, because of the considerable difference in ionic radii from the other alkali metals, formed separate minerals. In the case of cesium, this seems to have occurred in far fewer cases than for lithium, yielding the only commercial cesium mineral, *pollucite* [6, 7].

Pollucite is a cesium aluminum silicate, which typically contains 18–26% cesium oxide. The theoretical content is 42%, but usually pollucite contains considerable quantities of quartz. Its appearance is also very similar to that of quartz. For this reason and because the demand for cesium has not been great enough to result in any systematic exploration for cesium minerals, possibly further deposits may be discovered. Well known are the large deposits at Bernic Lake in Canada, at Bikita in Zimbabwe, and in South-West Africa. In the CIS, a new mineral, *cestibantite*, a mixed cesium–antimony–tantalum oxide, was reported [8], and pollucite findings have been reported in some deposits of lithium, niobium, and tantalum minerals [9, 10]. Apparently, pollucite also occurs in Afghanistan [11]. Small concentrations of cesium, less than one percent, are found in lepidolite, a lithium mineral.

### 54.3 Production

For any of the production methods described, pollucite must be powdered first. Production processes can be categorized as (1) decomposition with bases and (2) acid digestion. The second category includes the group of processes used industrially.

*Alkaline decomposition* can be carried out either by mixing ore with lime and calcium chloride and heating to 800–900 °C followed by leaching of the residue [12] or by heating pollucite with sodium chloride and soda ash to 600–800 °C followed by leaching [13]. In both cases, solutions of impure cesium chloride result. Recently, hydrothermal alkaline leaching with  $\text{Ca}(\text{OH})_2$  [14] has been developed as an industrial process to yield a low-

purity cesium hydroxide directly from pollucite [15, 16]; operating conditions are 200–280 °C and high pressure.

*Acid digestion* can be carried out with hydrochloric acid, sulfuric acid, or hydrobromic acid. Treatment of pollucite with hydrochloric acid at elevated temperature produces a solution of chlorides of cesium, aluminum, and alkali metals, which is separated from the silica residue. The cesium is precipitated as mixed chloride with lead, antimony, or tin. Hydrolysis precipitates the auxiliary metal [17]. Alternatives are precipitation with hydrogen sulfide or recovery of cesium by solvent extraction from the leach liquor [18] or ion exchange from cesium chloride solution.

Treatment of pollucite with sulfuric acid [12, p. 5] yields sparingly soluble cesium alum, cesium aluminum sulfate, which is roasted with carbon to convert the aluminum to alumina and the sulfate sulfur to  $\text{SO}_2$ . The residue is leached to obtain a cesium sulfate solution, which can be converted to the desired salts by ion exchange, treatment with ammonia or lime (to precipitate aluminum), or solvent extraction [19]. Hydrobromic acid converts pollucite into a solution of bromides of cesium, aluminum, and impurity metals, from which cesium can be precipitated by addition of alcohol. Leaching the precipitate with bromine selectively extracts cesium as  $\text{CsBr}_3$  [20].

Cesium metal can be produced as an amalgam by electrolyzing concentrated cesium salt solutions on a mercury cathode [21], but reduction of solid cesium salts, especially the halides, with calcium or barium at elevated temperature and removal of cesium by vacuum distillation is the usual method [22].

### 54.4 Compounds

*Cesium carbonate*,  $\text{Cs}_2\text{CO}_3$ , 81.58% Cs, is a colorless, hygroscopic powder, decomp. at 610 °C,  $\rho$  4.07 g/cm<sup>3</sup>, solubility of 261.5 g in 100 g of water, basic solution.

*Cesium hydrogencarbonate*,  $\text{CsHCO}_3$ , 68.54% Cs, colorless crystalline powder, de-

comp. at 175 °C, solubility of 209 g in 100 g of water, basic solution.

*Cesium chloride*,  $\text{CsCl}$ , 78.9% Cs, colorless, crystalline, hygroscopic powder, *mp* 642 °C,  $\rho$  3.983 g/cm<sup>3</sup>, solubility of 186 g in 100 g of water.

*Cesium hydroxide*,  $\text{CsOH}$ , 88.66% Cs, anhydrous, colorless, lumpy solid, *mp* 272 °C,  $\rho$  3.68 g/cm<sup>3</sup>, solubility of ca. 400 g in 100 g of water. The solution is a strong base and very caustic.

*Cesium hydroxide monohydrate*,  $\text{CsOH} \cdot \text{H}_2\text{O}$ , 79.14% Cs, colorless, crystalline, hygroscopic powder, *mp* 205–208 °C,  $\rho$  3.5 g/cm<sup>3</sup>, solubility of ca. 860 g in 100 g of water. The solution is a strong base and very caustic.

*Cesium iodide*,  $\text{CsI}$ , 51.2% Cs, colorless, slightly hygroscopic powder, *mp* 621 °C,  $\rho$  4.51 g/cm<sup>3</sup>, solubility of 74 g in 100 g of water.

*Cesium nitrate*,  $\text{CsNO}_3$ , 68.19% Cs, colorless crystalline powder, *mp* 414 °C,  $\rho$  3.69 g/cm<sup>3</sup>, oxidant.

*Cesium sulfate*,  $\text{Cs}_2\text{SO}_4$ , 73.46% Cs, colorless hygroscopic powder, *mp* 1010 °C,  $\rho$  4.243 g/cm<sup>3</sup>.

### 54.5 Quality Specifications

Cesium metal and cesium salts are marketed in purities from 99% for technical grades to 99.999% for high-purity compounds. For some applications, a crude form with approx. 85% purity can also be produced.

### 54.6 Analysis

Assays and purities of commercial products are derived by subtracting the sum of analyzed impurity levels from unity. Alkali-metal impurities are analyzed by emission spectroscopy, whereas alkaline-earth metals are determined by atomic absorption. Other metals and anions, such as phosphate and sulfate, can be determined by photometric methods; chloride is established argentometrically.

### 54.7 Storage and Transportation

Special precautions are necessary for cesium metal, which is shipped in evacuated glass ampules or steel containers with an appropriate outer packing to ensure that the metal is kept from air and moisture under any conditions.

Many cesium salts, especially halides, are hygroscopic and must be stored dry. Transportation regulations, where they exist, are governed by the anion, i.e., the hydroxide being caustic, the nitrate being an oxidant, because nothing inherent in the cesium cation calls for special precautions.

### 54.8 Uses

Cesium *metal* is used in frequency standards, especially the time standards known as atomic clocks, which lock in on one frequency of excited gas-phase cesium. The metal is also used in the production of various types of vacuum tubes, where it acts as a scavenger to reduce residual gaseous impurities after the tubes have been sealed. The cesium is normally generated in situ by firing the tube to convert a pellet of cesium chromate mixed with a metal powder to elemental cesium vapor.

In ion thrusters, cesium metal is the propellant. It is ionized in a vacuum chamber, and cesium ions are then accelerated through a field and ejected through a nozzle, producing a high specific impulse because of their high atomic mass. Devices of this type are used in satellites for orientation control.

Recognition that the reserves of fossil fuels are limited has focused considerable research on conversion of solar energy into electricity. One approach to achieve this uses thermionic converters, which require cesium. Direct conversion of heat from nuclear reactors into electricity by generating a voltage difference across a cesium vapor-filled vacuum tube between hot and cold electrodes has been proposed [23]. Another potential use of cesium

metal for energy generation is its use as a plasma seeding agent in closed-cycle magnetohydrodynamic generators that use high-temperature nuclear reactors as their heat source.

Of the *compounds*, the halides (especially the chloride), the trifluoroacetate, and the sulfate are used in ultracentrifuges, where aqueous solutions of high-purity grades are a medium for separation and purification of nucleic acids (DNA and RNA) for biochemical research. At high rates of rotation, these solutions form a density gradient that separates nucleic acids according to their densities [24].

Various catalysts can be doped with cesium salts as activators, much like the corresponding potassium salts. High-purity cesium halides are transparent to infrared radiation; therefore, they are used for cuvettes, prisms, and windows for spectroscopic equipment. Cesium iodide can be doped to make it a scintillator [25]; single crystals are used in scintillation counting equipment. Cesium fluoride is used for fluorination in organic chemistry.

Open-cycle magnetohydrodynamic generators could offer a considerable potential for cesium compounds as a plasma seeding agent. These devices are under development, especially in North America and the former Soviet Union, with the hope that they can boost the overall efficiency of power plants that depend on fossil fuels from ca. 35 to ca. 45%. Hot combustion gas is seeded with potassium or cesium carbonate to make a highly conductive plasma, which is passed through a magnetic field. At right angles to both the field and the direction of plasma flow, there is a voltage difference [26]. Nevertheless, the higher seeding efficiency of cesium compounds must compete with the lower price of potassium compounds.

Recently, the very low toxicity of the cesium cation and the pronounced physical and chemical properties of cesium formate to form clear solutions of high density (up to 2.3 tonnes/m<sup>3</sup>) have attracted considerations to use these solutions as brines in oil and gas well drilling [27], alone or in mixtures with sodium or potassium formate.

## 54.9 Economic Aspects

The producers do not publish production or consumption figures. The U.S. Bureau of Mines estimated world consumption in 1978 at about 20 t of cesium, as metal and in compounds. At that time prices for cesium salts were \$64–81 per kg for technical grades and \$147–170 per kg for high-purity products. The price levels in 1996 are \$35–85 per kg for technical and pure grades, and \$85–150 per kg for high-purity salts.

## 54.10 Toxicology and Occupational Health

The *cesium ion* itself is only very slightly toxic, more toxic than the sodium ion, but less toxic than the potassium ion. Typical LD<sub>50</sub> values of cesium salts are 1400 mg/kg (rat, intraperitoneal) and 1000 mg/kg (rat, oral) [28]. Exceptions are caused by the toxicity of the particular anion. Cesium hydroxide is strongly caustic, cesium nitrate is an oxidant, and cesium fluoride exhibits the typical toxicity of fluoride. Special precautions are necessary when handling the metal because exposure to this substance results in severe caustic burns.

## 54.11 References

1. *Gmelin*, system no. 25, Cæsium (1938).
2. *Kirk-Othmer*, 3rd ed., vol. 5, pp. 327–338.
3. C. A. Hampel: *Rare Metals Handbook*, 2nd ed., Reinhold Publ. Co., New York 1969.
4. W. Peek, *Chem.-Ztg.* **87** (1963) 315–318.
5. *Handbook of Chemistry and Physics*, 53rd ed., CRC Press, Cleveland 1972–1973.
6. V. M. Goldschmidt: *Geochemistry*, Clarendon Press, Oxford 1954.
7. V. V. Gordiyenko, *Int. Geol. Rev.* **13** (1970) no. 2, 134.
8. P. Černý: *Mineralogy of Rubidium and Cesium, Short Course Handb. Mineral. Assoc. Can.* **8**, 1982, 149–161.
9. V. F. Durnev, G. B. Melentyev, V. A. Sokolov, Y. N. Pokrovskiy, G. A. Cherepivskaya, *Doklady Akademii Nauk SSSR* **213** (1973) no. 1, pp. 180–183.
10. L. G. Kuznetsova, B. M. Shmakin, *Zap. Vses. Mineral. O-va.* **110** (1981) 1, 59–70.
11. L. N. Rossovskii, *Doklady Akademii Nauk SSSR* **236** (1977) no. 1, pp. 216–219.
12. K. C. Dean, P. H. Johnson, I. L. Nichols, *Rep. Invest. U.S. Bur. Mines* **6387** (1964).

13. W. D. Arnold, D. J. Crouse, K. B. Brown, *Ind. Eng. Chem.* **4** (1965) 249.
14. Y. G. Goroshchenko, E. B. Panasenko, V. A. Roi, V. P. Izotov, *Tsvetnye Metally* **2** (1961) no. 5, pp. 57–59.
15. Metallgesellschaft AG, DE 4237954 C1 (M. Wegner, K. Köbele, H. Hofmann, H. Prinz).
16. Metallgesellschaft AG, DE 4339062.5-41 (K. Schade, K. Köbele, H. Hofmann, H. Prinz).
17. J. C. Bailor, Jr.: *Inorganic Syntheses*, vol. 4, McGraw-Hill, New York 1965.
18. *Chem. Eng. News* **41** (1963) no. 51 (Dec. 23), 35.
19. H. W. Parsons, J. A. Vezina, R. Simard, H. W. Smith, *Can. Dept. Mines, Mineral Branch, Tech. Bull.* **50** (1963), reprint of *Can. Metall. Q.* **2** (1963) 1–13; *Chem. Abstr.* **58** (1963) 12199c.
20. V. A. Stenger, US 2481455, 1949.
21. R. E. Davis: "Electrowinning of Rubidium and Cesium", *Encyclopedia of Electrochemistry*, Reinhold Publ. Co., New York 1964.
22. L. Hackspill, *Helv. Chim. Acta* **11** (1928) 1003.
23. J. Raloff, *Sci. News (Washington, DC)* **113** (1978) no. 13, 202.
24. J. Vinograd, J. E. Hearst: *Equilibrium Sedimentation of Macromolecules and Viruses in a Density Gradient*, Springer-Verlag, Wien 1962.
25. P. Brinckmann, US 3446745, 1966.
26. J. Melcher, *Min. Eng. (Littleton, CO)* **29** (1977) no. 12, 34.
27. Shell Internationale Research Maatschappij B.V., Europe Patent Application 0259939 A3 (A. J. Clarke-Sturman, P. L. Sturla).
28. K. W. Cochran et al., *Arch. Ind. Hyg. Occup. Med.* **1** (1950) 637.

## 55 Alkali Sulfur Compounds

LUDWIG LANGE, WOLFGANG TRIEBEL (§§ 55.1–55.8); JOSÉ JIMÉNEZ (§ 55.9); ADOLF METZGER (§ 55.10); MANFRED R. WOLF (§ 55.11)

|        |  |      |         |   |      |
|--------|--|------|---------|---|------|
| 55.1   | Introduction   | 2221 | 55.9.5  | Sodium Hydrogensulfite                                  | 2235 |
| 55.2   | Compounds of the System $\text{Na}_2\text{S}-\text{S}$               | 2221 | 55.9.6  | Sodium Sulfite  | 2235 |
| 55.2.1 | Physical Properties  | 2221 | 55.9.7  | Analysis of Alkali-Metal Sulfites                       | 2236 |
| 55.2.2 | Chemical Properties  | 2224 | 55.9.8  | Toxicology  | 2236 |
| 55.3   | Production of Compounds of the System $\text{Na}_2\text{S}-\text{S}$ | 2226 | 55.10   | Thiosulfates  | 2236 |
| 55.3.1 | Sodium Tetrasulfide  | 2226 | 55.10.1 | General Properties                                      | 2236 |
| 55.3.2 | Sodium Disulfide   | 2227 | 55.10.2 | Sodium Thiosulfate                                      | 2236 |
| 55.3.3 | Sodium Monosulfide   | 2227 | 55.10.3 | Ammonium Thiosulfate                                    | 2238 |
| 55.4   | Sodium Hydrogensulfide   | 2228 | 55.10.4 | Toxicology  | 2239 |
| 55.4.1 | Properties   | 2229 | 55.11   | Sodium Dithionite                                       | 2239 |
| 55.4.2 | Production   | 2229 | 55.11.1 | Introduction  | 2239 |
| 55.5   | Uses of Sulfides   | 2229 | 55.11.2 | Properties  | 2240 |
| 55.6   | Safety and Environmental Aspects                                     | 2232 | 55.11.3 | Production  | 2241 |
| 55.7   | Economic Aspects   | 2233 | 55.11.4 | Quality Specifications and Analysis                     | 2241 |
| 55.8   | Transportation   | 2233 | 55.11.5 | Trade Names and Uses                                    | 2242 |
| 55.9   | Sulfites and Disulfites  | 2234 | 55.11.6 | Safety and Environmental Aspects; Storage and Transport | 2242 |
| 55.9.1 | General Properties   | 2234 | 55.11.7 | Economic Aspects  | 2243 |
| 55.9.2 | Ammonium Sulfite   | 2234 | 55.11.8 | Toxicology  | 2243 |
| 55.9.3 | Potassium Disulfite  | 2234 | 55.12   | References  | 2243 |
| 55.9.4 | Sodium Disulfite   | 2234 |         |   |      |

### 55.1 Introduction

Sulfur-sulfur bonds occur in numerous inorganic, organic, and biologically interesting compounds. One reason for this is the high bond energy of the S-S single bond (265 kJ/mol). This is the third strongest single bond, after  $\text{H}_2$  (435 kJ/mol) and the C-C single bond (330 kJ/mol) [1].

Of the compounds of sulfur with metals, only the alkali and alkaline earth sulfides, which contain the  $\text{S}^{2-}$  ion [2], and the corresponding hydrogensulfide, are soluble in water. The sulfides of the alkali and alkaline earth metals undergo addition of sulfur with conversion to polysulfides, which can also be regarded as salts of the sulfanes [3].

### 55.2 Compounds of the System $\text{Na}_2\text{S}-\text{S}$

#### 55.2.1 Physical Properties

The  $\text{Na}_2\text{S}-\text{S}$  phase diagram has been widely investigated [4–8], with essentially consistent results being obtained [9]. Above 285 °C the phase diagram (Figure 55.1) contains two liquid regions: a sodium-rich, single-phase region in which the composition moves continuously towards  $\text{Na}_2\text{S}_5$  as the sulfur content increases, and a two-phase region where two immiscible liquids— $\text{Na}_2\text{S}_5$  saturated with sulfur, and sulfur saturated with  $\text{Na}_2\text{S}_5$ —coexist [5, 10]. In the sodium-rich part of the diagram, the liquidus curve between  $\text{Na}_2\text{S}_2$  and  $\text{Na}_2\text{S}_4$  shows an eutectic, which lies at 235 °C according [5], and at  $240 \pm 2$  °C according to [11]. According to [5], the eutectic corre-

sponds to the composition  $\text{Na}_2\text{S}_3$ ; earlier investigations indicated the composition  $\text{Na}_2\text{S}_{3.24}$ . X-Ray diffraction experiments have shown that  $\text{Na}_2\text{S}_3$  does not exist as a defined polysulfide in the solid state [12]. The solid product with the stoichiometric composition  $\text{Na}_2\text{S}_3$  contains only  $\text{Na}_2\text{S}_2$  and  $\text{Na}_2\text{S}_4$  [13].

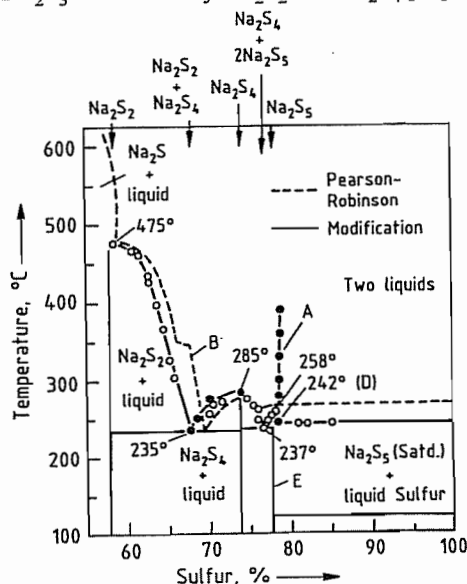
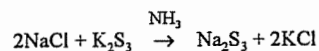

Figure 55.1: Phase diagram of the Na-S system between the compositions  $\text{Na}_2\text{S}_2$  and 100% S [7].

Although the above results show that solid sodium trisulfide is unstable, the situation is different for the molten state [14]. A melt with the composition  $\text{Na}_2\text{S}_3$  consists of a mixture of  $\text{Na}_2\text{S}_3$ ,  $\text{Na}_2\text{S}_2$ , and  $\text{Na}_2\text{S}_4$  [14]. In spite of the undoubted presence of the  $\text{S}_3^{2-}$  ion in  $\text{K}_2\text{S}_3$ ,  $\text{BaS}_3$ , etc., Raman spectroscopy shows that in molten  $\text{Na}_2\text{S}_3$  the ion disproportionates into  $\text{S}_2^{2-}$  and  $\text{S}_4^{2-}$  ions [15]. Thus, the compositions of the known alkali polysulfides are as listed below [8]:

|                       |   |                         |                         |
|-----------------------|---|-------------------------|-------------------------|
| $\text{Li}_2\text{S}$ | $\text{Li}_2\text{S}_2$                       | $\text{Na}_2\text{S}_4$ | $\text{Na}_2\text{S}_5$ |
| $\text{Na}_2\text{S}$ | $\alpha$ -, $\beta$ - $\text{Na}_2\text{S}_2$ | $\text{K}_2\text{S}_4$  | $\text{K}_2\text{S}_5$  |
| $\text{K}_2\text{S}$  | $\text{K}_2\text{S}_2$                        | $\text{Rb}_2\text{S}_4$ | $\text{Rb}_2\text{S}_5$ |
| $\text{Rb}_2\text{S}$ | $\text{Rb}_2\text{S}_2$                       | $\text{Cs}_2\text{S}_4$ | $\text{Cs}_2\text{S}_5$ |
| $\text{Cs}_2\text{S}$ | $\text{Cs}_2\text{S}_2$                       | $\text{Cs}_2\text{S}_3$ | $\text{Cs}_2\text{S}_4$ |

The following route to  $\text{Na}_2\text{S}_3$  has been proposed on the basis of the differing solubilities of NaCl and KCl in liquid ammonia (NaCl: 3.02 g/100 g solution; KCl: 0.04 g/100 g solution) [8, 11].



The question of whether  $\text{Na}_2\text{S}_3$  can be synthesized was partially elucidated when it was shown that the compound can exist as an ammoniate [11]. X-Ray and thermogravimetric measurements at various temperatures on powdered samples showed that ammonia can be removed at 370 K without fundamentally changing the structure [11]. The eutectoid decomposition reaction is hindered, at least kinetically, at low temperature [11].

Experiments on the melting and crystallization processes in the sodium sulfur cell show remarkable behavior by some sodium polysulfide compounds [16]. The melting temperatures of, e.g., polycrystalline  $\text{Na}_2\text{S}_4$  and  $\text{Na}_2\text{S}_5$  are reproducible for the first melting process, but in subsequent melting and crystallization cycles, the two compounds behave like the products of eutectic composition. With the exception of the disulfide, the polysulfides can form supercooled melts, and vitreous states have been observed. Some data on the melting behavior of polysulfides are given in Table 55.1 [16].

Table 55.1: Melting behavior of polysulfides.

| Polysulfide composition      | 1st melting |                                  | Remelting     |         |
|------------------------------|-------------|----------------------------------|---------------|---------|
|                              | mp, °C      | $\Delta H_{\text{fus}}$ , kJ/mol | Remelt cycles | mp, °C  |
| $\text{Na}_2\text{S}_2$      | 474         | 7.48                             | 3             | 474     |
| $\text{Na}_2\text{S}_{3.0}$  | 234         | 15.62                            | 3             | 234     |
| $\text{Na}_2\text{S}_{3.3}$  |             |                                  | 2             | 241     |
| $\text{Na}_2\text{S}_{4.0}$  | 283         | 28.85                            | 3             | 240     |
| $\text{Na}_2\text{S}_{4.2}$  |             |                                  | 3             | 207–234 |
| $\text{Na}_2\text{S}_{4.6}$  |             |                                  | 2             | 240–260 |
| $\text{Na}_2\text{S}_{5.0}$  | 258         | 32.55                            | 3             | 213–231 |
| $\text{Na}_2\text{S}_{5.2}$  | 255         | 30.41                            | 2             | 220–241 |
| $\text{Na}_2\text{S}_{5.3}$  |             |                                  | 10            | 219–247 |
| $\text{Na}_2\text{S}_{6.1}$  | 254         | 27.89                            | 11            | 236–246 |
| $\text{Na}_2\text{S}_{10.0}$ | 254         | 29.36                            | 4             | 205–247 |
|                              |             |                                  | 3             | 205–265 |

**Sodium monosulfide**,  $\text{Na}_2\text{S}$ , like  $\text{Li}_2\text{S}$ ,  $\text{K}_2\text{S}$ ,  $\text{Rb}_2\text{S}$ ,  $\text{Li}_2\text{O}$ ,  $\text{Na}_2\text{O}$ , and  $\text{K}_2\text{O}$ , crystallizes with the antifluorite structure, in which each S atom is surrounded by a cube of 8 Na atoms, and each Na atom by a tetrahedron of 4 S atoms [15]. The mp is  $1170 \pm 10$  °C [17], the heat of fusion  $\Delta H_{\text{fus}} = 30.1$  kJ/mol [20], the standard

entropy  $S_{298}^0 = 90.3$  JK<sup>-1</sup>mol<sup>-1</sup> [17], and the heat of formation  $\Delta H_{298} = -386.6$  kJ/mol, based on [19, 20].

**Sodium disulfide** crystallizes in two modifications [12]. The transformation from the  $\alpha$ - to the  $\beta$ -modification takes place in the temperature range 150–250 °C [12]. The change in structure is irreversible. Products that solidify from the melt or are tempered at high temperature have the  $\beta$ -structure, which is isotypical with that of  $\text{Li}_2\text{O}_2$  [21]. Sodium disulfide isolated from alcoholic solution exists in the  $\alpha$ -modification, isotypical with the structure of  $\text{Na}_2\text{O}_2$  [21]. The sodium disulfide was prepared in alcoholic solution by the method proposed in [22] in which an alcoholic solution of sodium tetrasulfide is reduced with sodium metal [12].

The specific heat capacity  $c_p$  of  $\alpha$ - $\text{Na}_2\text{S}_2$  was found to be constant at 1071 Jkg<sup>-1</sup>K<sup>-1</sup> over the temperature range 97–167 °C [16].

For  $\beta$ - $\text{Na}_2\text{S}_2$  in the range 191–267 °C,  $c_p$  is 1113 Jkg<sup>-1</sup>K<sup>-1</sup> [16]. The relative density  $d_{20}$  of  $\alpha$ - $\text{Na}_2\text{S}_2$  is 2.01, and that of  $\beta$ - $\text{Na}_2\text{S}_2$ , 2.05. The color of  $\text{Na}_2\text{S}_2$  is yellow to orange.

**Sodium tetrasulfide**. The crystal structure of  $\text{Na}_2\text{S}_4$  is described in [23]. The structure of the  $\text{S}_4^{2-}$  ions in sodium tetrasulfide is shown in Figure 55.2 [24].

The interatomic distance  $d$  of the sulfur atoms is 207 pm, the valency angle  $\alpha$  is 109.8°, and the torsion angle  $\tau$  is 98° [24].

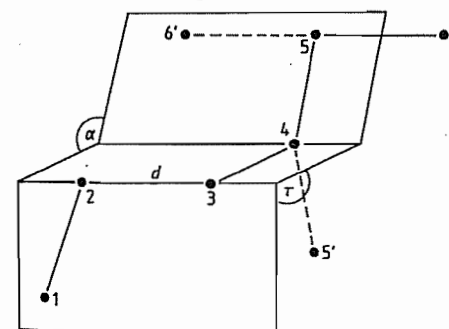

Figure 55.2: Structural principle of the ions  $\text{S}_4^{2-}$ ,  $\text{S}_5^{2-}$ , and  $\text{S}_6^{2-}$  [24]. In  $\text{S}_4^{2-}$ , atoms 5 and 6 or 5' and 6' are absent, and in  $\text{S}_5^{2-}$ , atom 6 or 6' is missing. In  $\text{gg}'\text{-S}_5^{2-}$ , the fifth atom is in position 5. Likewise, the last atom of  $\text{ggg}'\text{-S}_6^{2-}$  would be in position 6'.

According to [24], reliable IR and Raman spectra of sodium tetrasulfide were first published in [25], the  $\text{Na}_2\text{S}_4$  spectra available until then having been falsified by the presence of lines due to the pentasulfide. The relative density of sodium tetrasulfide is  $d_{20} = 2.08$  [12].

**Sodium Pentasulfide**. Like  $\text{Na}_2\text{S}_2$  and  $\text{Na}_2\text{S}_4$ ,  $\text{Na}_2\text{S}_5$  in the solid state forms a structure that appears uniform by X-ray diffraction, and is therefore a true chemical compound with a definite chain length [12, 26]. The structure, shown in Figure 55.2 as  $\text{gg}'\text{-S}_5^{2-}$ , is based on the Raman spectrum of  $\text{Na}_2\text{S}_5$  [24]. The relative density of  $\text{Na}_2\text{S}_5$  is  $d_{20} = 2.08$  [12].

Some physical properties of anhydrous alkali metal sulfides are listed in Table 55.2 [27].

Table 55.2: Physical properties of the anhydrous alkali metal sulfides.

| Compound                | $\Delta H_f$ , kJ/mol | mp, °C | Density, g/cm <sup>3</sup> | $H_{\text{soln}}$ , 0 °C, kJ/mol |
|-------------------------|-----------------------|--------|----------------------------|----------------------------------|
| NaHS                    | -238.4                | 350    | 1.79                       | 16.0                             |
| KHS                     | -265.9                | 455    | 1.68–1.70                  | 0.4                              |
| RbHS                    | -262.1                |        |                            | 0.0                              |
| CsHS                    | -264.2                |        |                            | -1.7                             |
| $\text{Na}_2\text{S}$   | -376.6                | 1180   | 1.856                      | 65.1                             |
| $\text{K}_2\text{S}$    | -420.0                | 840    | 1.805                      | 94.5                             |
| $\text{Rb}_2\text{S}$   | -349.4                | 530    | 2.912                      | 103.4                            |
| $\text{Cs}_2\text{S}$   | -340.6                | 510    |                            | 114.4                            |
| $\text{Na}_2\text{S}_2$ | -443.6                | 445    |                            |                                  |
| $\text{K}_2\text{S}_2$  |                       | 470    | 1.973                      |                                  |
| $\text{Rb}_2\text{S}_2$ |                       | 450    | 2.79                       |                                  |
| $\text{Cs}_2\text{S}_2$ |                       | 460    | 3.83                       |                                  |
| $\text{Na}_2\text{S}_3$ | -450.7                | 275    |                            |                                  |
| $\text{K}_2\text{S}_3$  |                       | 252    | 2.102                      |                                  |
| $\text{Rb}_2\text{S}_3$ |                       | 210    | 2.68                       |                                  |
| $\text{Cs}_2\text{S}_3$ |                       | 217    | 3.47                       |                                  |
| $\text{Na}_2\text{S}_4$ | -413.3                | 285    | 2.08                       | 41.2                             |
| $\text{K}_2\text{S}_4$  | -474.6                | 145    |                            | 5.0                              |
| $\text{Cs}_2\text{S}_4$ |                       | 160    |                            |                                  |
| $\text{Na}_2\text{S}_5$ |                       | 253    | 2.08                       |                                  |
| $\text{K}_2\text{S}_5$  |                       | 206    |                            |                                  |
| $\text{Rb}_2\text{S}_5$ |                       | 230    | 2.67                       |                                  |
| $\text{Cs}_2\text{S}_5$ |                       | 211    |                            |                                  |
| $\text{K}_2\text{S}_6$  |                       | 196    | 2.02                       |                                  |
| $\text{Rb}_2\text{S}_6$ |                       | 201    |                            |                                  |
| $\text{Cs}_2\text{S}_6$ |                       | 186    |                            |                                  |

**Molten Sodium Polysulfide**. Conductivity data for some molten sodium polysulfides are plotted in Figure 55.3 [28]. The values are in the range expected for ionic liquids. At 340 °C, the conductivity  $\kappa$  of  $\text{Na}_2\text{S}_4$  is 0.45

$\Omega^{-1} \text{cm}^{-1}$ , which compares with  $1.11 \Omega^{-1} \text{cm}^{-1}$  for  $\text{NaNO}_3$  and  $0.87 \text{W}^{-1} \text{cm}^{-1}$  for  $\text{NaSCN}$  at the same temperature.

The conductivity increases with decreasing sulfur content approximately twofold from  $\text{Na}_2\text{S}_5$  to  $\text{Na}_2\text{S}_3$ . This is partly a result of the increasing ionic concentration as the proportion of sulfur decreases.

The conductivity of pure molten sulfur and of molten sulfur saturated with  $\text{Na}_2\text{S}_5$  is shown in Figure 55.4. The two "types of sulfur" show only small differences in their conductivities, in contrast to the conductivity of molten  $\text{Na}_2\text{S}_5$ . This shows that the solubility of  $\text{Na}_2\text{S}_5$  in sulfur is extremely low [28].

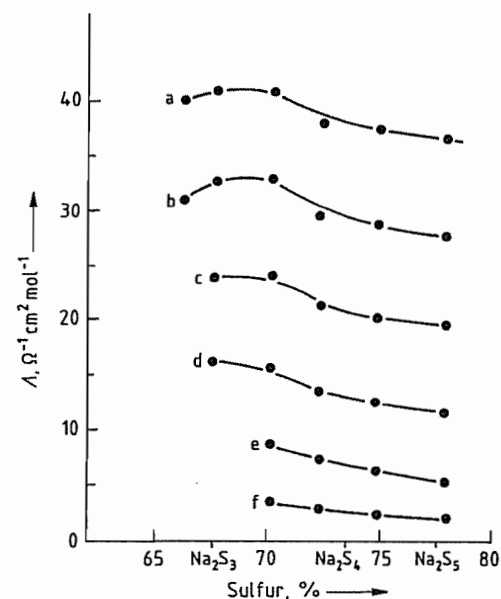

Figure 55.3: Equivalent conductivity plotted against % sulfur for fused sodium polysulfides [28]: a) 420 °C; b) 380 °C; c) 340 °C; d) 300 °C; e) 260 °C; f) 220 °C.

Table 55.3: Values of parameters in the equation  $\rho = D + E(T - 600)$ , describing the density of fused sodium polysulfides [29].

| Melt                        | S, % | Temperature range, K | $D, \text{g/cm}^3$ | $10^4 E, \text{g cm}^{-3} \text{K}^{-1}$ |
|-----------------------------|------|----------------------|--------------------|--|
| $\text{Na}_2\text{S}_3$     | 67.6 | 590–683              | 1.887              | -5.65                                    |
| $\text{Na}_2\text{S}_{3.3}$ | 69.7 | 576–689              | 1.901              | -7.96                                    |
| $\text{Na}_2\text{S}_{3.7}$ | 72.0 | 563–669              | 1.926              | -5.47                                    |
| $\text{Na}_2\text{S}_{4.4}$ | 75.4 | 571–680              | 1.869              | -6.66                                    |
| $\text{Na}_2\text{S}_{4.8}$ | 77.0 | 573–683              | 1.876              | -7.16                                    |

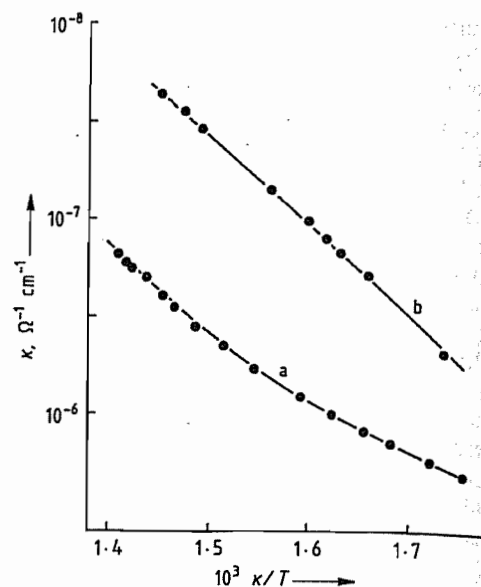

Figure 55.4: Temperature dependence of conductivity for liquid sulfur (a) and sulfur saturated with  $\text{Na}_2\text{S}_5$  (b) [28].

Density values for some sodium polysulfide melts are listed in Table 55.3 [29]. Comparing the densities of solid and liquid  $\text{Na}_2\text{S}_4$  and  $\text{Na}_2\text{S}_5$  shows that the transformation from solid to liquid is accompanied by a volume increase of ca. 8–10% [29].

## 55.2.2 Chemical Properties

**Sodium Monosulfide.** The chemical properties of sodium sulfide are described in detail in [30–32]. Anhydrous  $\text{Na}_2\text{S}$  is a white solid that readily reacts with moist air to form sodium sulfite and carbonate. Pure  $\text{NaHS}$  can be obtained by the action of  $\text{H}_2\text{S}$  on anhydrous  $\text{Na}_2\text{S}$ .

Sodium sulfide is very soluble in water. The concentration of a saturated solution of  $\text{Na}_2\text{S}$  at various temperatures is given below [33]:

| $\text{g Na}_2\text{S}/100 \text{ cm}^3$ | 12.2 | 16.0 | 21.3 | 28.0 | 33.0 | 40 |
|--|------|------|------|------|------|----|
| $T, ^\circ\text{C}$                      | 0    | 20   | 40   | 60   | 80   | 90 |

The relationship between %  $\text{Na}_2\text{S}$   $y$  and density  $x$  at various temperatures is given by [32]:

$$y = -98.24 + 98.28x \text{ at } 20^\circ\text{C}$$

$$y = -98.73 + 99.01x \text{ at } 30^\circ\text{C}$$

$$y = -98.40 + 99.01x \text{ at } 40^\circ\text{C}$$

Aqueous solutions [33] of sodium sulfide react alkaline due to hydrolysis:

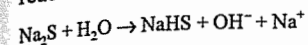

Iron compounds dissolve in hydrolyzed sodium sulfide solutions, forming thio complexes with an intense brown-red color. Iron metal is also attacked by concentrated  $\text{Na}_2\text{S}$  solutions.

$\text{Na}_2\text{S}$  solutions can dissolve sulfur up to a composition corresponding to  $\text{Na}_2\text{S}_5$ .

Sodium sulfide solutions are oxidized by  $\text{NaOCl}$  solutions; depending on the concentration of the reactants, the temperature, and the pH, various amounts of sulfur and sulfate are formed [32]. For dilute solutions of approximately constant concentration, the ratio of sulfur to sulfate formed is constant. With a large excess of sulfide, the formation of sulfur increases, and for a large excess of  $\text{NaOCl}$ , the formation of sulfate increases. Sulfate formation is favored by increased temperature. Maximum sulfate formation is observed at pH 10 [32].

Sodium sulfide is oxidized by the Karl Fischer reagent, presumably by the reaction [32]

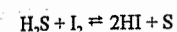

Sodium sulfide is appreciably soluble in the lower alcohols (methanol, ethanol) [33].

**Sodium Polysulfides.** The chemical properties of the sodium polysulfides are described in detail in [30, 31, 34, 35].

Sulfur dissolves readily in alkali metal sulfide solutions with formation of alkali metal polysulfides [35]. These solutions are strongly alkaline owing to the reaction

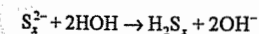

The  $\text{S}_8$  ring is broken by the thiophilic  $\text{S}^{2-}$  and  $\text{SH}^-$  ions in accordance with the equation

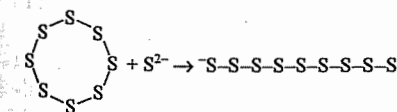

leading to the formation of nonasulfide ions which can break down to form shorter chains.

At the same time, longer chains are formed from  $\text{S}^{2-}$  ions (e.g.,  $\text{S}_2^{2-}$ ,  $\text{S}_3^{2-}$ , etc.) which can also undergo degradation. In solutions of alkali polysulfides produced from alkali sulfide and sulfur, these reactions take place in single steps and, therefore, constitute a complex dynamic equilibrium between sulfide ions of various chain lengths. This explains why aqueous solutions of polysulfide ions of definite chain length cannot be obtained by reaction of stoichiometric amounts of sulfur with sulfide. Addition of such solutions to cold hydrochloric acid always gives a mixture of sulfanes [35]. Furthermore, of the alkali metal polysulfides  $\text{M}_2\text{S}_m$ , only the pentasulfide dissolves without decomposition, dissociating to form  $\text{S}_5^{2-}$  ions [26]. Higher polysulfides with  $n > 5$  also form pentasulfide ions with precipitation of the excess sulfur, while the lower polysulfides ( $n < 5$ ) disproportionate into monosulfide, tetrasulfide, and pentasulfide ions, which are in pH-dependent equilibrium with each other [26, 36]:

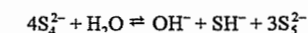

Free polysulfide ions consist of sulfur chains [36]. The sulfur atoms of an  $\text{S}_3^{2-}$  chain are necessarily coplanar, but for longer chains there are possibilities for isomerism, as shown in Figure 55.5. Thus, for the structure of the  $\text{S}_4^{2-}$  ion there are two possibilities (Figure 55.5A and B), for the  $\text{S}_5^{2-}$  ion there are the possible structures (C) and (D), and for the  $\text{S}_6^{2-}$  ion, the structure (E) [36]. The equilibrium between the polysulfide ions in aqueous solution also appears to influence the production of polymeric polysulfides, represented by the general equation

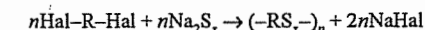

This is essentially a nucleophilic exchange between the halogen and the polysulfide anion. The exact nature of the polysulfide ions that react with the dihalides is not yet clear. The polymer initially formed on addition of dihalide to aqueous sodium polysulfide contains less sulfur than expected.

The degree of sulfur substitution (sulfur grade) is the average number of sulfur atoms

in each repeating unit of the polymer. However, if a polymer with, for example, a sulfur grade of 4, is treated with 1 mol  $\text{Na}_2\text{S}_4$ , the sulfur grade in the polymer decreases to 3.1, while that of the polysulfide solution increases by a corresponding amount [37].

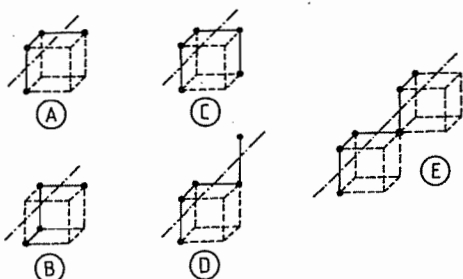
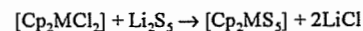
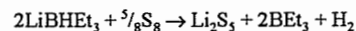

Figure 55.5: Idealized stereochemistry (dihedral angle equal to  $90^\circ$ ) for polysulfide ions [36]. A, B) *d*- and *l*- $\text{S}_4^{2-}$ ; C, D) *cis*- and *trans*- $\text{S}_5^{2-}$ ; E) *trans, trans*- $\text{S}_6^{2-}$ .

For reactions that must be carried out under anhydrous conditions, anhydrous polysulfide reagents can be prepared according to the following reaction scheme [38]:



where Cp = cyclopentadienyl and M = Ti, Zr, Hf, V. The so-called Super-Hydride method has been found to be very versatile for the preparation of polysulfide complexes of transition metals [38].

## 55.3 Production of Compounds of the System $\text{Na}_2\text{S}$ – $\text{S}$

Sodium tetrasulfide is nowadays produced from the elements in the absence of water and solvents on an industrial scale; sodium disulfide and sodium monosulfide can be prepared similarly on the laboratory scale [39–43].

A summary of the processes is given in Figure 55.6. The production of  $\text{Na}_2\text{S}_4$ ,  $\text{Na}_2\text{S}_2$ , and  $\text{Na}_2\text{S}$  is briefly described below.

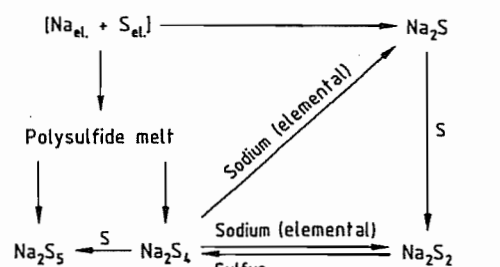

Figure 55.6: Some production routes to anhydrous, solvent-free sodium monosulfide and polysulfides.

### 55.3.1 Sodium Tetrasulfide

Sodium tetrasulfide is now produced on an industrial scale in high purity from the elements in the absence of water and solvents.

Molten polysulfide is charged into a cylindrical reactor, with no added water or solvent [39]. Molten sodium and sulfur are added alternately and are mixed with the melt by vigorous agitation. The heat of reaction is removed by a heat-transfer oil in contact with the outer wall of the reactor.

For optimum process operation, the temperature of the polysulfide melt should be in the range  $340$ – $360^\circ\text{C}$ .

As the molten polysulfide is extremely corrosive, the choice of construction materials is very important. The alloy AlMg appears to be sufficiently resistant. The atmosphere in the reactor is inerted with argon [39].

The preparation of the sodium polysulfides  $\text{Na}_2\text{S}_3$ ,  $\text{Na}_2\text{S}_4$ , and  $\text{Na}_2\text{S}_5$  on the laboratory scale by synthesis from the elements is described in [13]. An equimolar amount of sulfur is added to molten sodium in small amounts with agitation. The reaction product, consisting mainly of  $\text{Na}_2\text{S}_2$ , is cooled, size reduced, and then mixed at room temperature with the required amount of sulfur. The mixture is then melted. Unreacted sodium recovered from the size-reduced reaction product is then added to this polysulfide melt [13].

In another laboratory method, based on early work [5, 22],  $\text{Na}_2\text{S}_4$  was prepared in alcoholic solution from sodium, hydrogen sulfide, and sulfur [12]. In a widely cited preparation of sodium tetrasulfide or polysul-

fides from  $\text{Na}_2\text{S}$  and sulfur, alkali metal sulfide, prepared by the reduction of  $\text{Na}_2\text{SO}_4$ , is added to molten sulfur [44].

### 55.3.2 Sodium Disulfide

Sodium disulfide,  $\text{Na}_2\text{S}_2$ , is produced by adding a higher sodium polysulfide and sodium, either simultaneously or alternately, to a polysulfide melt [40]. As the melting point of  $\text{Na}_2\text{S}_2$  ( $474^\circ\text{C}$ ) is higher than the boiling point of sulfur, it is preferable to use sodium tetrasulfide. Thus, sodium disulfide free of water or solvent can be produced in an easily controlled process. The process has three variations [40]. The whole of the polysulfide can be pre-melted, and the sodium added to the melt until the desired stoichiometric composition is obtained, or sodium and, for example,  $\text{Na}_2\text{S}_4$  can be added to the melt either alternately or simultaneously [40].

There are many literature references to other methods of producing sodium disulfide. For example, sodium tetrasulfide can be dissolved in alcohol and then reduced with sodium metal to give sparingly soluble  $\text{Na}_2\text{S}_2$  [22]. It has not been possible to prove conclusively that the product so obtained, which contains 4–6% alcohol, represents a defined alcoholate [12]. High-purity  $\text{Na}_2\text{S}_2$  can be produced from the elements in liquid ammonia [12].

Small amounts of sodium polysulfide for the investigation of thermodynamic properties have been prepared by melting together  $\text{Na}_2\text{S}$  and sulfur in a small sealed capsule [16].

Sodium disulfide is produced on an industrial scale from sodium hydroxide solution and sulfur [45], and is used for the production of polysulfide polymers [37] (see Section 55.5).

### 55.3.3 Sodium Monosulfide

The most important processes for the production of  $\text{Na}_2\text{S}$  are described in detail in [30–32, 46]. Of these, the reduction of sodium sulfate with carbon is described in detail here.

Sodium sulfide is produced in large quantities by the reaction of anhydrous sodium sul-

fate with carbon in a process that has been used for decades. The reaction, which is carried out at  $700$ – $900^\circ\text{C}$ , is represented by the following overall equation [33]:

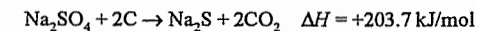

At ca.  $730^\circ\text{C}$ , the evolution of  $\text{CO}_2$  begins, and the reaction mass becomes very fluid. On further heating, it becomes pasty, and finally solid. This behavior can be explained by means of the sodium sulfate–sodium sulfide phase diagram (Figure 55.7) [33].

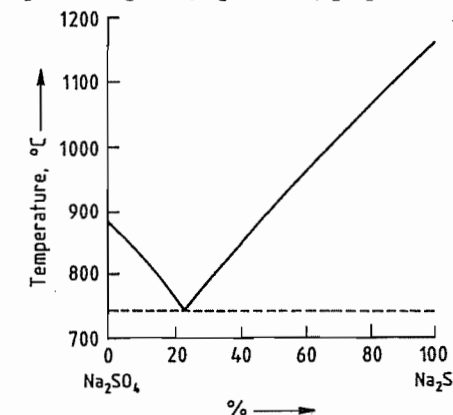

Figure 55.7: Phase diagram of the system  $\text{Na}_2\text{SO}_4$ – $\text{Na}_2\text{S}$  [31].

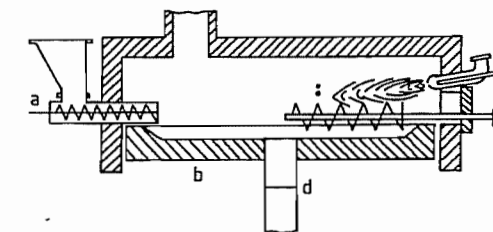

Figure 55.8: Rotating-hearth furnace [33]: a) Screw feeder; b) Rotating hearth; c) Transporting screw feeder; d) Discharge shaft; e) Burner.

The process details and the operation of the reactors or furnaces are described in patents [30]. The rotating-hearth furnace (Figure 55.8) operates fully continuous. The sulfate–carbon mixture is delivered by a water-cooled screw feeder (a), onto the outer part of the rotating hearth (b) [33]. As the hearth rotates, a second screw feeder (c) moves the mixture nearer to the center of the plate where the melt passes through the discharge shaft (d).

To ensure sufficient heat transfer to the reaction mixture, the temperature in the gas space of the furnace must be ca. 1100 °C. The furnace lining is strongly attacked by Na<sub>2</sub>S.

The sodium monosulfide so produced contains excess carbon, ash components, Na<sub>2</sub>CO<sub>3</sub>, Na<sub>2</sub>S<sub>2</sub>O<sub>3</sub>, and Na<sub>2</sub>SO<sub>3</sub>. The product is leached with water, and the undissolved components are removed by filtration. The solution is concentrated by evaporation to 60–62% Na<sub>2</sub>S. The concentrated solution, which solidifies at ca. 90 °C, is converted to the solid form by cooling on rolls or in pans [33]. Depending on process conditions, the purity of the sodium monosulfide obtained can vary between 50 and 98% [30]. The product can be purified in various ways, e.g., by removal of the strongly colored iron compounds from the sodium sulfide solution [47].

High-purity sodium monosulfide can be obtained by treating the reaction product with methanol to dissolve the sulfide, instead of water [48]. Unlike its hydrates, anhydrous sodium sulfide is very soluble in alcohols. The solubility of Na<sub>2</sub>S in methanol is 160 g/L at 20 °C, whereas that of Na<sub>2</sub>S·9H<sub>2</sub>O in methanol is only 30 g/L [48]. Other aliphatic, aromatic, and polyhydroxy alcohols can also be used as extractants: the solubility of Na<sub>2</sub>S in ethanol is 90 g/L, and in ethylene glycol > 200 g/L. The sodium sulfide obtained by evaporating the extractant is free of water, iron, sulfite, sulfate, and thiosulfate [48].

Sodium sulfide can also be obtained by reducing Na<sub>2</sub>SO<sub>4</sub> with hydrogen (Sulfigran process) [33], methane, or other hydrocarbons [30, 33, 46].

The reduction of sodium polysulfides with sodium amalgam to give high-purity monosulfide proceeds according to the following equation [33]:

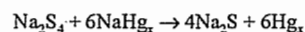
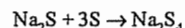

Anhydrous sodium monosulfide is obtained from moist, anhydrous sodium sulfide in a two-stage process [49].

Pure Na<sub>2</sub>S can be prepared on a laboratory scale from the elements using liquid ammonia

as solvent [12] or without the use of solvents [41–43]. Na<sub>2</sub>S has been prepared in the laboratory in two steps:

In the first step, one of three processes was carried out in a preheated kneading machine:

1. Solid Na<sub>2</sub>S<sub>4</sub> was charged into the machine and ground. Liquid sodium was then slowly added, maintaining the temperature of the reaction mixture at 120–250 °C by means of a heat-transfer oil [41]; or
2. Liquid sodium was charged into the machine, and solid sulfur was slowly added, maintaining the temperature of the reaction mixture at 120–250 °C by means of a heat-transfer oil [42]; or
3. Sulfur and sodium were added alternately to powdered sodium monosulfide, prepared by method 1 or 2, maintaining the temperature of the reaction mixture at 120–250 °C by means of a heat-transfer oil [43].

All of these first stages gave a blue-black powder as intermediate product.

In the second stage, the intermediate product was placed in a small reactor. The unreacted residues of sodium and sulfur in the black intermediate product were then allowed to react at 250–480 °C. A white sodium monosulfide was produced from all three products of the first stage. The purity of the Na<sub>2</sub>S so obtained was consistently > 95% [41–43].

## 55.4 Sodium Hydrogensulfide [33]

Sodium hydrogensulfide, NaHS, *mp* 350 °C, *d* 1.79, is a colorless to yellow solid. The anhydrous salt (95–98% NaHS) is of minor importance. In industry, the following low-iron hydrated products are used [46]:

- Sodium hydrogensulfide solution (30% NaHS)
- Sodium hydrogensulfide flakes (70% NaHS)
- Sodium hydrogensulfide powder (95% NaHS)

### 55.4.1 Properties [33]

Sodium hydrogensulfide is very soluble in water [32]. The variation of solubility with temperature is shown below:

|                            |    |    |    |    |    |    |
|----------------------------|----|----|----|----|----|----|
| g NaHS/100 cm <sup>3</sup> | 41 | 50 | 55 | 60 | 65 | 72 |
| T, °C                      | 5  | 22 | 35 | 39 | 43 | 65 |

Sodium hydrogensulfide forms two hydrates, NaHS·2H<sub>2</sub>O and NaHS·3H<sub>2</sub>O. The aqueous solution has an alkaline reaction.

The solid products are strongly hygroscopic, and are oxidized by atmospheric oxygen.

### 55.4.2 Production [33]

Sodium hydrogensulfide is usually obtained by the action of hydrogen sulfide on sodium sulfide or sodium hydroxide solution. If hydrogen sulfide is passed over anhydrous high-percentage sodium sulfide at ca. 300 °C, high-percentage sodium hydrogensulfide is obtained [50]. According to a patent, anhydrous sodium hydrogensulfide is obtained by the reaction of sodium metal with hydrogen sulfide in inert organic solvents [51], and high-percentage solid products can be obtained by the evaporation of aqueous solutions [52].

Hydrated products are obtained by reacting hydrogensulfide with solutions of sodium sulfide or sodium hydroxide (e.g., in spray towers). If sodium hydroxide solution is used, it should be noted that the sodium sulfide formed as an intermediate is less soluble than the end product. Problems arising from this can be avoided by a patented method [53]. Another patent [54] describes how the difference between the solubilities of sodium sulfide and sodium hydrogensulfide can be exploited by allowing hydrogen sulfide to react with sodium sulfide (60% Na<sub>2</sub>S) in lump form in a tower, controlling the temperature so that the sodium hydrogensulfide runs off, leaving behind the sodium sulfide as a solid.

The hot solutions obtained using pure hydrogen sulfide can be converted to solid products by cooling without intermediate treatment. If the hydrogen sulfide contains carbon dioxide, Na<sub>2</sub>CO<sub>3</sub> is formed in the solu-

tions in addition to NaHS. A process for obtaining pure products from such solutions is described in a patent [55]. Another patent describes how NaHS solutions can be produced from H<sub>2</sub>S-containing gaseous by-products of petroleum refining [56].

## 55.5 Uses of Sulfides

Much of the new knowledge of the system Na<sub>2</sub>S–S mentioned above has come from research into sodium sulfur cells. However, the Na<sub>2</sub>S<sub>*n*</sub> compounds that are formed and decomposed in these cells are initially produced from the elements sodium and sulfur, so that the batteries that contain these cells have no economic implications for the production and use of anhydrous, solvent-free sodium polysulfide compounds [10, 57].

An established application is in the production of *sulfur dyes* [58], which are produced by the two methods:

- The polysulfide bake method, where sulfur or sulfur–sodium sulfide is heated in the dry state with aromatic amino or nitro compounds or with nitrogen-free organic substances such as cresol, anthracene, or decacyclene
  - The polysulfide melt method, in which organic compounds are refluxed with polysulfide in an aqueous or alcoholic medium
- The water-insoluble sulfur dyes are dissolved by reduction to the leuco form, generally with sodium sulfide. The leuco dyes become attached to the fibers, and the sulfur dye is then fixed on the fiber by oxidation with peroxides or perborates [58].

Anhydrous, solvent-free sodium tetrasulfide is extensively used in the production of *organosilanes*, which are used in the rubber industry:

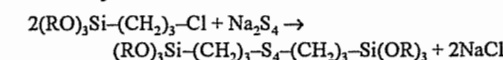

The ethyl derivative of bis(trialkoxysilylpropyl) tetrasulfide (Si 69) is one of the most important organofunctionalized silanes [59]. Organosilanes are used in the rubber industry in combination with various fillers to produce



elastomers with improved static and dynamic vulcanizate properties [60]. These silanes have two different reactive groups that react with the silanol groups of fillers during compounding in rollers or kneaders, and form chemical bonds to the polymer and cross-linking agents during vulcanization. Si 69 can also be used as a sulfur donor that gives reversion-free vulcanization (equilibrium cure system) [60].

Another example of the use of an anhydrous sulfide is in a process for producing poly(phenylene sulfide) [34, 61, 62]. In the production of poly(phenylene sulfide), 1,4-dichlorobenzene and sodium sulfide are reacted at ca. 280 °C under pressure in a polar aprotic solvent, usually *N*-methyl-2-pyrrolidone [63]. While aliphatic polysulfides can easily be prepared by nucleophilic exchange reactions of chloride with sulfide, the reaction with aromatic compounds is much more difficult because of the considerably lower reactivity of the aromatically bonded chlorine [34]. It has been suggested that formation of poly(phenylene sulfide) does not proceed like a normal polycondensation [64]. The reaction is a one-electron transfer process in which radical cations act as reactive intermediates [64]. Poly(phenylene sulfide) can be used with very high contents (up to 70%) of fillers such as glass fiber, carbon fiber, or minerals. Its good chemical resistance (PPS is practically insoluble in all the usual solvents) and inherent flame-retardant properties enable it to be used under severe thermal and chemical conditions. Reinforced PPS can replace metals in many applications, e.g., in the construction of machinery and equipment, pump housings, and gear wheels [63].

Sodium sulfide, sodium hydrogensulfide, and sodium polysulfide are sometimes used in the same fields of application [32]. This is also true to some extent of the sulfanes, although their instability prevents their large-scale use [33]. Examples are the manufacture of polysulfide polymers and the sulfide reduction of polynitroaromatics, both described below.

*Aliphatic polysulfides* of the thiokol type have the general formula  $(C_xH_{2x}S_y)_n$ . These

find wide application [61] as sealants and, in combination with epoxy resins, as adhesives and mastics. These products have a marked ability to expand and contract, are elastic over a wide temperature range, and are resistant to seawater, solvents, and many chemicals. The best known commercial products are the Thiokols, which are polyalkyl- and polyalkoxy-polysulfides. They are produced by the condensation of  $Na_2S_n$  with dichloroalkyls and bischloroalkylformals [66, 67]. Trichloroalkanes [68], epichlorohydrin [69], condensation products of  $\alpha$ -monochlorohydrin formaldehyde [70], and monochloro alcohols [67] are also used as modifiers in the condensation reaction. The basic properties of these polysulfides mainly depend on the sulfur content [37]. The  $Na_2S_n$  compounds can be obtained by the reaction of NaOH with sulfur [45]. At temperatures of < 110 °C and with NaOH concentrations of < 30%, polysulfide and thiosulfate are formed according to the equation

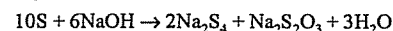

whereas at higher NaOH concentrations (up to 35%) and higher temperatures (100–320 °C) sulfite is also formed [45]:

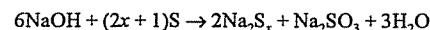

The autoxidation of aqueous polysulfide solutions in the temperature range 23–40 °C, the kinetics of polysulfide–thiosulfate disproportionation [71, 72], and equilibria of polysulfide ions in solution [73] should be mentioned in this connection [74]. The reaction usually proceeds very rapidly from sulfite to thiosulfate, so that only small amounts of sulfite remain. However, as sulfite crystallizes from concentrated NaOH solution, small amounts of thiosulfate remain in the solution [75].

The polymers produced by the reaction of alkyl chlorides with sodium polysulfide are obtained as high molecular mass, rubber-like products with a very limited range of uses. The polymers can be selectively cleaved by the action of sodium hydrogen sulfide on the disulfide groups, allowing the average chain length to be controlled [76].

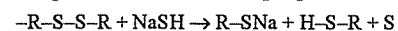

The sulfur liberated in this reaction reacts with added sodium sulfite to form sodium thiosulfate [76]:

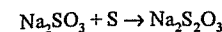

The bis(vinylarylalkyl) polysulfides [77], obtained by reacting 4-vinylbenzyl chloride with  $Na_2S-S$ , are used as coatings and sealants in the form of copolymers with halogenated alkanes.

*Aromatic amino compounds* can be prepared by the reduction of polynitroaromatics with sulfide [78]. Sulfide reductions are carried out in industry with  $Na_2S$ , NaHS,  $Na_2S_2$ , or ammonium sulfide solutions. The reactions are not exactly stoichiometric, proceeding approximately in accordance with the following equations:

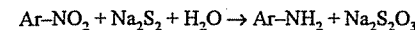
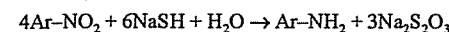
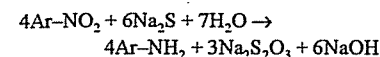

Some other important products obtained by using the sulfide reaction are 1,2-diamino-4-nitrobenzene from 2,4-dinitroaniline and NaSH; 2-amino-4-nitrophenol from 2,4-dinitrophenol and NaSH; and 4,6-dinitro-2-aminophenol (picraminic acid) from picric acid and NaSH [78].

To reduce friction and increase load-bearing capacity, EP (extreme-pressure) and AW (antiwear) oil additives are added to engine oils, transmission oils, turbine oils, and machining oils and their emulsions [79, 80]. It is known that sulfur-containing compounds in which the sulfur is in "available" form perform especially well in this application. Especially suitable are those compounds with polysulfide bridges in which the sulfur atoms are in a labile, active form, are liberated at elevated temperature, and can form metal sulfide coatings on the metal surface. These coatings usually have a lower coefficient of friction than the metal itself and thus improve frictional behavior [79, 80].

These sulfur-containing compounds can be prepared by reacting epoxides with an alkali metal disulfide or tetrasulfide [79]:

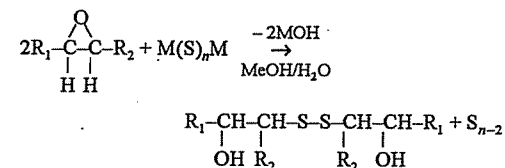

In accordance with the above reaction scheme, elemental sulfur is liberated when  $Na_2S_4$  is used [79].

Oil additives can also be produced by the reaction of  $Na_2S$  or  $Na_2S_n$ , often in combination with elemental sulfur, with chlorinated organic compounds. These compounds can be formed by the addition of an S–Cl compound (e.g.,  $S_2Cl_2$ ) to a double bond (e.g., isobutene), and then condensed with  $Na_2S-S$  [81–86]. Other products may be obtained from the reaction of aromatic hydroxy compounds (e.g., 2,6-di-*tert*-butylphenol or 2,4,6-tri-*tert*-butylphenol) with aldehydes or ketones and  $Na_2S$  [87].

The reaction of 4-chlorotetrahydropyran with  $Na_2S$  in a methanol/ethanol mixture, followed by hydrogen peroxide oxidation of the resulting thiol group leads to bis(tetrahydropyran)disulfide, which is used as a lubricant additive [88].

Dialkylbenzyl disulfides, which are used as oil additives, are produced from a catalytically cracked naphtha fraction (boiling range 164–250 °C), which is chloromethylated with formaldehyde–HCl, and then reacted with  $Na_2S_2$  [89].

In a similar process, benzyl chloride and  $Na_2S_2$  are reacted at 80–90 °C for 20 h to produce dibenzyl disulfide, which is used as a component of an oil additive [90].

The production of additives for high-pressure lubricants is described in [91]. A mixture of xylol isomers is chloromethylated and then reacted with  $Na_2S_3$  (a mixture of  $Na_2S_2$  and  $Na_2S_4$ ) to form a polysulfide.

A group of microcrystalline Al–Na silicates with various sulfur contents have been referred to as ultramarines [92]. Analysis gives an approximate empirical formula of  $(Na_8Al_6Si_6O_{24}S_4)_n$ , suggesting the name sodium aluminum silicate polysulfide.

The production of an *ultramarine* and a green pigment from zeolites and  $\text{Na}_2\text{S}_3$  by heating to  $> 300^\circ\text{C}$  has been reported [93]. The color of the ultramarines may be due to singly charged polysulfide(-1) radical ions [94, 95].

Sodium monosulfide solutions mixed with  $\text{FeSO}_4$ ,  $\text{Ca}(\text{OH})_2$ , and a polymeric flocculating agent are used to remove copper from aqueous solutions, process liquors, and wastewater [96]. Lead can be removed by using a mixture of caustic soda solution, sodium monosulfide solution, and aluminum chloride [97].

## 55.6 Safety and Environmental Aspects [98]

Sodium sulfide and  $\text{Na}_2\text{S}_n$  are classified as irritants in GefStoffV [99], as indicated by the hazard symbol C.

The following R and S phrases are applicable:

R31: "Toxic gases produced on contact with acids"

R34: "Causes irritation"

S26: "On contact with eyes, rinse immediately with plenty of water, and seek medical help"

S45: "In case of accident or illness, seek medical help immediately. Show this label if possible."

In accordance with GefStoffV vessels containing  $\text{Na}_2\text{S}$  or  $\text{Na}_2\text{S}_n$  should carry the name of the substance in permanent printed letters, the hazard symbol "irritant", the hazard information R 31–34, and the safety advice S 26–45 [100, 101].

Aqueous solutions of  $\text{Na}_2\text{S}$ ,  $\text{NaHS}$ , and sodium polysulfides must always be maintained at a pH of  $> 10$  to prevent liberation of toxic hydrogen sulfide [3]. The hazardous properties of hydrogen sulfide and its effects on humans are described in [33].

Solid sodium sulfide, sodium hydrogensulfide, and sodium polysulfide form strongly alkaline solutions when dissolved in water, and these can cause severe irritation of the eyes and skin. Goggles must therefore be worn. When working with larger quantities, impermeable protective clothing consisting of rubber boots (not leather-soled shoes) and long rubber gauntlets must also be worn.

If dust is formed, respirators with combination B/P2 type filters (color code: gray with white ring) must be worn [100].

In case of fire, respiratory equipment with an independent air supply must be used, completely sealed chemically-resistant clothing must be worn while fighting the fire, and the auxiliary equipment used must be resistant to caustic solutions [100]. Note that sulfide solutions can emit hydrogen sulfide on heating, which can represent a potential hazard during storage or in production [32].

Industrial safety data for sodium sulfide, sodium polysulfide, and sodium hydrogensulfide are given in [98, 102].

Sulfide is classified as a hazardous substance according to § 7a of the German Water Management Act [103]. In accordance with the current state of the art of the process in which by-product sulfide is formed, the sulfide content of wastewater has to be reduced. This can be carried out in various ways, e.g., by oxidation of the alkaline solution with  $\text{H}_2\text{O}_2$  [104]:

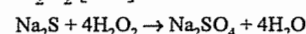

The limit values for the sulfide content of wastewater are taken from the Framework Wastewater Directive or a recommendation of the German wastewater technical association (ATV) for indirect dischargers. Some values (in mg/L) are listed below [105]:

|   |     |
|---|-----|
| Appendices to Framework Wastewater Directive (1992)   |     |
| Appendix 25 (leather manufacture, fleece treatment, leather fiber production): wastewater from soaking, liming, and deliming, including washing | 2   |
| Appendix 37 (manufacture of inorganic pigments): Source type 1.1.3 (lithopone, zinc sulfide pigment, and precipitated barium sulfate)           | 1   |
| Appendix 39 (manufacture of nonferrous metals)  | 1   |
| Appendix 40 (metal working and treatment)   |     |
| Source type 1.1.1 (electrolytic)  | 1   |
| Source type 1.1.2 (pickling)  | 1   |
| Source type 1.1.4 (burnishing)  | 1   |
| Source type 1.1.7 (printed circuit manufacture)   | 1   |
| Source type 1.1.8 (battery manufacture)   | 1   |
| Source type 1.1.9 (enamelling)  | 1   |
| Appendix 47 (scrubbing of furnace combustion gases)   | 0.2 |
| 34th Framework Wastewater Directive (manufacture of barium compounds)   | 1   |
| 38th Framework Wastewater Directive (textile manufacture)   | 0.1 |
| 43rd Framework Wastewater Directive (synthetic fibers): Source type 2.1.3 (manufacture of viscose spun fiber)                                   | 15  |

Wastewater technical association (ATV)  
Information sheet A 115 (yellow printing)

2

## 55.7 Economic Aspects [106]

Sodium monosulfide is supplied commercially in the form of flakes containing 60–62%  $\text{Na}_2\text{S}$ .

Major producers of the monosulfide include Tessenderlo Chemie (Belgium) and Foret (Spain). There are also producers in Germany, Italy, and France.

The output of sodium monosulfide in Western Europe is estimated to be 50 000 t/a. Excluding the considerable quantities exported to the African copper mines, this consumption is distributed among the following areas of use:

|   |     |
|---|-----|
| Dehairing agents for the leather industry             | 40% |
| Precipitation of heavy metal ions (chemical industry) | 30% |
| Production of sulfur dyes                             | 20% |
| Other uses  | 10% |

Sodium hydrogensulfide is supplied in the following forms:

- In powder form with a purity of 95%
- In flake form with a purity of 70–74%
- As a 30% solution

Sodium hydrogensulfide is manufactured by the sodium monosulfide producers mentioned above, and also by Goldschmidt, Rhodanid Chemie, and Leuna. The main producers in the United States are Jupiter Chemical, PPG Industries, and Ethyl Corp.

As sodium hydrogensulfide is used in the same areas as  $\text{Na}_2\text{S}$ , no reliable information is available concerning the production and consumption of  $\text{NaHS}$  in Western Europe. In the United States, about two-thirds of annual production (i.e., ca. 180 000 t/a) is of lower quality (low grade, 20–30%  $\text{NaHS}$ ) and is used in the cotton industry.

For many years, sodium polysulfide has been available only in solution. Sodium polysulfide solution is supplied by Goldschmidt (Germany), Witton (United Kingdom), PPG (United States), and Sankyo Kasei (Japan).

Approximately 25 000 t/a polysulfide solution, produced mainly by Morton International

(United States), Toray Thiokol (Japan), and Akcros (Greiz-Dolau, Germany), is used in the production of polysulfide elastomers.

Sodium polysulfides are also available in anhydrous and solvent-free form, but the price of this material is considerably higher than that of the aqueous solution.

## 55.8 Transportation [107]

Sodium sulfide with at least 30% water of crystallization is classified as follows:

|                  |                             |
|------------------|-----------------------------|
| RID/ADR          | Class 8, no. 45 b           |
| IMDG Code        | Class 8, UN no. 1849, PG II |
| ICAO-TI/IATA-DGR | Class 8, UN no. 1849, PG II |

Approved packaging for sodium sulfide has been harmonized for all means of transport. Intermediate bulk containers are permitted for land and sea transport. Portable tanks (rail tank cars, road tank cars, tank containers) are permitted for land and sea transport.

Sodium sulfide with less than 30% water of crystallization is classified as follows:

|                  |                               |
|------------------|-------------------------------|
| RID/ADR          | Class 4.2, no. 13b            |
| IMDG Code        | Class 4.2, UN no. 1385, PG II |
| ICAO-TI/IATA-DGR | Class 4.2, UN no. 1385, PG II |

Approved packaging has been harmonized for all means of transport, and must be hermetically sealed. Bags are not permitted for sea transport. Bags may be used for land transport provided they are loaded on pallets and forwarded as full load. Intermediate bulk containers are only permitted for land and sea transport. Portable tanks (rail tank cars, road tank cars, tank containers) are permitted only for land transport.

Sodium hydrogensulfide with at least 25% water of crystallization is classified as follows:

|                 |                             |
|-----------------|-----------------------------|
| RID/ADR         | Class 8, no. 45 b           |
| IMDG Code       | Class 8, UN no. 2949, PG II |
| ICA-TI/IATA-DGR | Class 8, UN no. 2949, PG II |

Packaging has been harmonized for all means of transport. Intermediate bulk containers and portable tanks are permitted for land and sea transport.

Sodium hydrogensulfide with less than 25% water of crystallization is classified as follows:

|           |                               |
|-----------|-------------------------------|
| RID/ADR   | Class 4.2, no. 13 b           |
| IMDG Code | Class 4.2, UN no. 2318, PG II |

ICAO-TI/IATA-DGR Class 4.2, UN no. 2318, PG II  
Packaging has been harmonized for all means of transport, and must be hermetically sealed. Bags are not permitted for sea transport, but can be used for land transport provided they are loaded on pallets and forwarded as full load. Intermediate bulk containers are permitted for land and sea, and portable tanks only for land transport.

Sodium polysulfides are not specifically named in the transport regulations, but should be classified as follows:

|                  |                                     |
|------------------|-------------------------------------|
| RID/ADR          | Class 8, no. 45 b                   |
| IMDG Code        | Class 8, UN no. 1759, PG II (solid) |
|                  | Class 8, UN no. 1760, PG II (solid) |
| ICAO-TI/IATA-DGR | Class 8, UN no. 1759 PG II (solid)  |
|                  | Class 8, UN no. 1760 PG II (liquid) |

Packaging has been harmonized for all means of transport. Intermediate bulk containers and portable tanks are permitted for land and sea transport, with restrictions for solid polysulfide in portable tanks.

## 55.9 Sulfites and Disulfites

### 55.9.1 General Properties

Sulfurous acid is formed on passing sulfur dioxide into water:

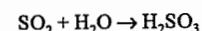

Since the equilibrium lies almost completely on the left-hand side and gas hydrates are formed on cooling the solution, isolation of the anhydrous acid is not possible. The acid dissociates in two steps:

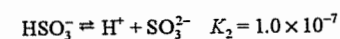
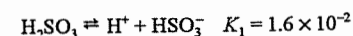

The dissociation constants  $K$  refer to 25 °C [108]. At higher concentrations the disulfite ion is formed:

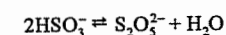

The neutral alkali-metal sulfites  $\text{M}_2\text{SO}_3$  and hydrogensulfites  $\text{MHSO}_3$  are readily soluble in water. The latter cannot be isolated, since

they are converted to disulfites on concentrating the solution.

Sulfurous acid and its salts are used as reducing agents. Aqueous solutions of halogens are reduced to hydrogen halides, iodates to iodides, and dichromates to chromium(III). However, sulfurous acid behaves as an oxidizing agent in the presence of stronger reducing agents; for example, with sulfur, thiosulfates are formed.

### 55.9.2 Ammonium Sulfite [109]

Solutions of ammonium sulfite,  $(\text{NH}_4)_2\text{SO}_3$ , are produced by treating sulfur dioxide with aqueous ammonia. They are mainly used for the production of ammonium thiosulfate.

### 55.9.3 Potassium Disulfite [110]

The industrial production of potassium disulfite,  $\text{K}_2\text{S}_2\text{O}_5$ , is similar to that of sodium disulfite. It is used for combatting fungi on vines and in wine production.

### 55.9.4 Sodium Disulfite [111]

Sodium disulfite,  $\text{Na}_2\text{S}_2\text{O}_5$ , dissolves readily in water with the formation of sodium hydrogensulfite  $\text{NaHSO}_3$  (see Figure 55.9) [112].

The fine crystalline salt can be stored without any problem if kept cool, dry, and with the exclusion of air. When moist it is oxidized by atmospheric oxygen to the sulfate.

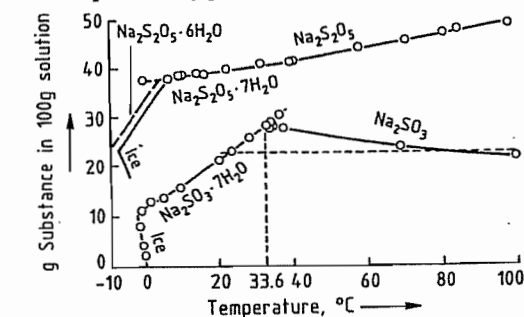

Figure 55.9: Solubility of  $\text{Na}_2\text{S}_2\text{O}_5$  and  $\text{Na}_2\text{SO}_3$  in water as a function of temperature.

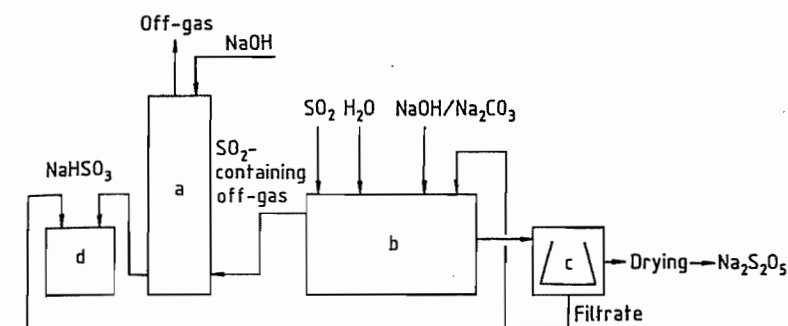

Figure 55.10: Production of sodium disulfite and sodium hydrogensulfite solution: a) Scrubber; b) Production plant; c) Centrifuge; d) Storage vessel for sodium hydrogensulfite solution.

Sodium disulfite is produced by treating 50–70% sodium hydroxide or a suspension of sodium carbonate with sulfur-dioxide-containing gases in saturated sodium hydrogensulfite solution (Figure 55.10) [113–116]. The sodium disulfite is removed by centrifugation and then dried. The saturated mother liquor from the centrifuge is mixed with the liquor from the waste-gas scrubber and adjusted to the usual commercial concentration.

Sodium disulfite production is coupled with the formation of sodium hydrogensulfite solution, for which, therefore, a demand must also exist. Production processes that use an anhydrous route, involving treatment of sodium sulfite or sodium carbonate with sulfur dioxide, have not achieved industrial importance.

Equipment and storage containers are predominantly made from 1.4571 grade stainless steel. Fiberglass-reinforced plastic containers are also suitable for storage. Paper or plastic sacks, steel barrels, or big bags made of synthetic fibers are used for transportation.

The commercial product has a content of ca. 97%  $\text{Na}_2\text{S}_2\text{O}_5$ , 1–2%  $\text{Na}_2\text{SO}_3$ , and ca. 1%  $\text{Na}_2\text{SO}_4$ .

Sodium disulfite is used in the photography and fiber industries, for preserving foodstuffs, for wastewater treatment, and in the paper, textile, and leather industries.

### 55.9.5 Sodium Hydrogensulfite [111]

Sodium hydrogensulfite,  $\text{NaHSO}_3$ , is not known in the solid state. On concentrating an aqueous solution, solid sodium disulfite crystallizes. Sodium hydrogensulfite is oxidized in air. Solutions of high purity can be produced by dissolving sodium disulfite in water. Commercial solutions are produced as the mother liquor in the production of sodium disulfite or by treating a suspension of sodium hydroxide, or sodium sulfite or sodium carbonate with sulfur dioxide until a pH of 3.5–4 is reached. The equipment is mainly made of 1.4571 grade stainless steel. For storing the solution, fiberglass-reinforced plastic containers are also suitable.

### 55.9.6 Sodium Sulfite

Sodium sulfite,  $\text{Na}_2\text{SO}_3$ , is predominantly marketed as the anhydrous salt. It is produced by treating a suspension of sodium hydroxide or sodium carbonate with sulfur dioxide. The temperature is maintained at 60–80 °C for optimal crystal separation. The sodium sulfite suspension formed is centrifuged and the salt dried. Today part of the sodium sulfite is obtained from scrubbing of  $\text{SO}_2$ -containing off-gases. Production processes using an anhydrous route have not yet achieved industrial importance.

Sodium sulfite is sold in various purity grades containing 90–98%  $\text{Na}_2\text{SO}_3$ . The salt can be stored for long periods if kept dry, with

the exclusion of air. It is transported in plastic and paper sacks. Sodium sulfite is used as a reducing agent, for the production of sodium thiosulfate, in the photography, paper, and textile industries, for treating boiler water, and as a food preservative.

### 55.9.7 Analysis of Alkali-Metal Sulfites

The total sulfur dioxide content is titrated iodometrically. Sulfate is determined, after acidification of the solution with HCl and driving off the SO<sub>2</sub> with CO<sub>2</sub>, either titrimetrically or as barium sulfate. To determine sulfite in sodium hydrogensulfite or sodium disulfite, the sample solution is treated with formalin and the NaOH liberated is titrated in the presence of phenolphthalein.

### 55.9.8 Toxicology

Oral administration of a few grams of sodium sulfite causes dizziness, vomiting, and diarrhoea [117]. Small doses of sodium hydrogensulfite are oxidized to sulfate in vivo, whereas larger doses cause considerable irritation of the gastrointestinal tract.

## 55.10 Thiosulfates

### 55.10.1 General Properties

Thiosulfates are the salts of thiosulfuric acid, H<sub>2</sub>S<sub>2</sub>O<sub>3</sub>. Whereas thiosulfuric acid is highly unstable, thiosulfates are quite stable, even in aqueous solution.

Most thiosulfates are readily soluble in water, with the exception of the moderately soluble barium salt and the sparingly soluble silver and lead salts. The soluble salts are readily crystallized. Acid salts do not exist.

The following properties are characteristic of thiosulfates: decomposition to sulfur and sulfur dioxide in acid solution:

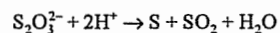

decomposition in alkaline solution according to the equation:

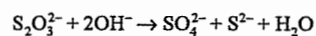

oxidation by weak oxidizing agents (I<sub>2</sub>, Fe<sup>3+</sup>, and Cu<sup>2+</sup>) to give tetrathionate:

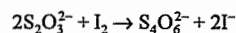

and oxidation by strong oxidizing agents (Cl<sub>2</sub>, Br<sub>2</sub>, MnO<sub>4</sub><sup>-</sup>, and Cr<sub>2</sub>O<sub>7</sub><sup>2-</sup>) to give sulfate:

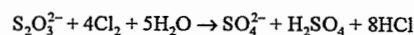

The use of thiosulfates as antichlorines for removal of chlorine (e.g., from bleached materials) is based on the last-mentioned reaction. With heavy metals (e.g., silver) the thiosulfate ion forms soluble complexes [Ag(S<sub>2</sub>O<sub>3</sub>)<sub>2</sub>]<sup>3-</sup>. This property is used in photography for fixing.

Sodium and ammonium thiosulfates are important industrial chemicals.

### 55.10.2 Sodium Thiosulfate

Sodium thiosulfate is produced and sold as the anhydrous salt, and as the pentahydrate Na<sub>2</sub>S<sub>2</sub>O<sub>3</sub>·5H<sub>2</sub>O. The hydrated product was formerly known as antichlorine, because of the earlier wide use for removal of residual chlorine.

**Properties.** Sodium thiosulfate crystallizes from aqueous solution as short, colorless prisms or elongated crystals. It effloresces in dry air, particularly at temperatures above ca. 33 °C. At 48 °C the crystals dissolve in their own water of crystallization. The solution tends to become supersaturated and can be kept in this state for weeks at room temperature. Spontaneous crystallization only occurs on supercooling to -30 °C or below. On heating, preferably with stirring and under reduced pressure, the anhydrous salt is obtained as a heavy, white, crystalline powder. Anhydrous Na<sub>2</sub>S<sub>2</sub>O<sub>3</sub> is also produced by dehydration of Na<sub>2</sub>S<sub>2</sub>O<sub>3</sub>·5H<sub>2</sub>O in a stream of dry air at temperatures of up to 60 °C. At 223 °C sodium thiosulfate decomposes, predominantly giving sodium sulfate and pentasulfide:

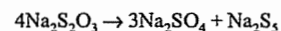

The pentahydrate, which exists in two modifications, is stable below 48 °C. Four modifi-

cations of anhydrous Na<sub>2</sub>S<sub>2</sub>O<sub>3</sub> are known [118].

Aqueous solutions of sodium thiosulfate are of neutral pH. They can be kept for months in the dark with the exclusion of air, but decompose on prolonged boiling in air. On addition of acid sulfur precipitates and sulfur dioxide is liberated. The densities of aqueous Na<sub>2</sub>S<sub>2</sub>O<sub>3</sub> solutions at 20 °C are listed below:

| [Na <sub>2</sub> S <sub>2</sub> O <sub>3</sub> ], % | ρ, g/cm <sup>3</sup> |
|---|----------------------|
| 1   | 1.0065               |
| 2   | 1.0148               |
| 4   | 1.0315               |
| 8   | 1.0654               |
| 10  | 1.0827               |
| 12  | 1.1003               |
| 16  | 1.1365               |
| 20  | 1.1740               |
| 24  | 1.2128               |
| 28  | 1.2532               |
| 30  | 1.2739               |
| 35  | 1.3273               |
| 40  | 1.3827               |

Table 55.4 lists the solubility in water; other properties are given in Table 55.5 and [119].

Table 55.4: Solubility of sodium thiosulfate in water.

| Solid phase  | T, °C | %    |
|--|-------|------|
| Ice  | -3.9  | 15.0 |
|  | -11   | 30.0 |
| Na <sub>2</sub> S <sub>2</sub> O <sub>3</sub> ·5H <sub>2</sub> O   | 0     | 34.4 |
|  | 20    | 41.2 |
|  | 40    | 50.6 |
| Na <sub>2</sub> S <sub>2</sub> O <sub>3</sub> ·2H <sub>2</sub> O   | 48    | 62.0 |
|  | 50    | 62.9 |
|  | 60    | 67.4 |
| Na <sub>2</sub> S <sub>2</sub> O <sub>3</sub> ·0.5H <sub>2</sub> O | 65    | 69.5 |
|  | 70    | 70.0 |
|  | 75    | 70.8 |
| Na <sub>2</sub> S <sub>2</sub> O <sub>3</sub>                      | 80    | 71.0 |
|  | 100   | 72.7 |

Table 55.5: Properties of sodium thiosulfate.

|   | Na <sub>2</sub> S <sub>2</sub> O <sub>3</sub> ·5H <sub>2</sub> O | Na <sub>2</sub> S <sub>2</sub> O <sub>3</sub> |
|---|--|---|
| Crystal system  | monoclinic   | monoclinic                                    |
| ρ at 25 °C, g/cm <sup>3</sup>                                     | 1.749  | 2.267   |
| Specific heat capacity at 0 °C, Jkg <sup>-1</sup> K <sup>-1</sup> | 1453   | 924   |
| Heat of fusion, kJ/kg   | 148.1  |   |
| Heat of solution at 25 °C, kJ/kg                                  | 190.6  |   |
| Heat of hydration at 18 °C, kJ/mol                                | 55.7   |   |
| Enthalpy of formation, kJ/mol                                     | 2601   |   |

**Production** of sodium thiosulfate is based on the following reactions:

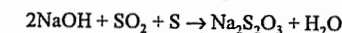
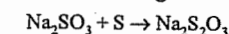

The raw materials are usually used in a technically pure form and consist of sulfur (solid or liquid), sodium sulfite, sodium hydrogensulfite, sodium hydroxide, and sulfur dioxide. The latter is used either as a pure gas or as a sulfur combustion gas containing ca. 18% SO<sub>2</sub>.

The addition of sulfur to sodium sulfite is carried out in stirred vessels. The reaction rate depends on the temperature, the excess of sulfur, and the intensity of stirring. The reaction lasts for several hours.

Polysulfide solutions are also produced to some extent as intermediates and react with disulfite to give thiosulfate [120]. Processes have also been described involving the production of sodium thiosulfate by oxidation of aqueous sodium sulfide solutions in the presence of catalysts [121–123].

The sodium thiosulfate solutions are filtered hot, sometimes with the addition of decolorizing charcoal. The excess sulfur is recycled. The Na<sub>2</sub>S<sub>2</sub>O<sub>3</sub>·5H<sub>2</sub>O is crystallized by cooling the filtrate. The mother liquor still contains ca. 5% Na<sub>2</sub>S<sub>2</sub>O<sub>3</sub> at 20 °C. Further sodium thiosulfate can be obtained from this mother liquor by evaporation. The crystalline salt is separated by centrifugation. The pentahydrate must be dried below ca. 40 °C because at higher temperatures water of crystallization is lost. Pneumatic-conveyor or fluidized-bed driers are used.

Anhydrous sodium thiosulfate is produced by dehydration of the pentahydrate at 60–105 °C at atmospheric or reduced pressure. Another possibility is crystallization from sodium thiosulfate solution above 70 °C.

The standard commercial particle sizes are obtained by using continuous or batch crystallization equipment.

**Quality Specifications and Analysis.** For photographic purposes the degree of purity laid down in the ASA and DIN/ISO standards is, usually adequate (99% for Na<sub>2</sub>S<sub>2</sub>O<sub>3</sub>·5H<sub>2</sub>O

and 97% for anhydrous  $\text{Na}_2\text{S}_2\text{O}_3$ ). The content of sodium thiosulfate is determined potentiometrically by titration of the diluted solution with iodine solution [124–126].

Both types of sodium thiosulfate are produced in Germany at Chemiewerk Bad Köstritz and anhydrous  $\text{Na}_2\text{S}_2\text{O}_3$  is produced by Th. Goldschmidt AG, Werk Mannheim; Brotherton, England; and Foret, Spain, for example.

**Uses.** Anhydrous sodium thiosulfate is now only added in small quantities to ammonium thiosulfate. The hydrated salt is used as an antichlorine in bleaching, in wastewater purification, for reduction of dichromate in chromed leather production, and as a solvent for silver chloride in the chloride roasting of silver-containing minerals.

Table 55.6: Solubility of ammonium thiosulfate.

| T, °C | Solubility |                                   |
|-------|------------|-----------------------------------|
|       | in water   | in $\text{NH}_3$ -saturated water |
| 0     | 60.0       |                                   |
| 10    | 61.6       |                                   |
| 20    | 63.1       | 25.8                              |
| 30    | 64.7       | 38.1                              |
| 40    | 66.3       | 46.5                              |
| 50    | 67.9       | 58.2                              |
| 60    | 69.4       | 65.9                              |
| 70    | 71.0       | 70.7                              |
| 80    | 72.6       | 72.4                              |
| 90    | 74.2       |                                   |

### 55.10.3 Ammonium Thiosulfate

**Properties.** Ammonium thiosulfate,  $(\text{NH}_4)_2\text{S}_2\text{O}_3$ , crystallizes in an anhydrous form as shiny plates or sword-shaped crystals. No hydrates are known. On heating to 150 °C it sublimes with partial decomposition into  $(\text{NH}_4)_2\text{SO}_3$ , S,  $\text{NH}_3$ , and  $\text{H}_2\text{S}$ . Ammonium thiosulfate is hygroscopic; the stability limit is at 64% relative humidity. It is readily soluble in water, sparingly soluble in acetone, and insoluble in alcohol. The solubility in water is lowered by the presence of  $\text{NH}_3$ . The solubilities are listed in Table 55.6. The densities of aqueous solutions at 20 °C are listed below:

| $(\text{NH}_4)_2\text{S}_2\text{O}_3$ , % | $\rho$ , g/cm <sup>3</sup> |
|---|----------------------------|
| 56  | 1.303                      |
| 57  | 1.310                      |
| 58  | 1.314                      |

|    |       |
|----|-------|
| 59 | 1.319 |
| 60 | 1.324 |
| 61 | 1.329 |
| 62 | 1.334 |

The data are for technical grades, which contain ca. 0.2%  $\text{NH}_3$  and small quantities of sulfate and sulfite. Aqueous ammonium thiosulfate solutions decompose slowly on heating above 40 °C with formation of sulfur and sulfate. A small quantity of sulfite stabilizes the solutions considerably. Some other properties are as follows:

|   |            |
|---|------------|
| 100% $(\text{NH}_4)_2\text{S}_2\text{O}_3$                        |            |
| Crystal system  | monoclinic |
| $\rho$ at 25 °C, g/cm <sup>3</sup>                                | 1.71       |
| Heat of solution, water, 25 °C, kJ/kg                             | 105        |
| 58–60% $(\text{NH}_4)_2\text{S}_2\text{O}_3(\text{aq})$           |            |
| Thermal conductivity, $\text{kJm}^{-1}\text{h}^{-1}\text{K}^{-1}$ | 1.84       |
| Specific heat capacity, $\text{kJkg}^{-1}\text{K}^{-1}$           | 2.45       |
| Vapor pressure, kPa at 20 °C                                      | 1.7        |
| at 40 °C  | 5.4        |
| at 60 °C  | 14.2       |

**Production** of ammonium thiosulfate is based on the reaction of sulfur, or occasionally ammonium sulfide and polysulfides [127], with ammonium sulfite in an aqueous ammoniacal medium. The ammonium sulfite is produced from ammonia or ammonia water and  $\text{SO}_2$  in the same or in a separate process step:

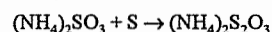
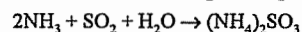

The sulfur dioxide is used neat (gaseous or liquid) or as sulfur combustion gas, and sulfur is used in liquid or solid form.

The rate of reaction of sulfur with ammonium sulfite depends on the temperature, the intensity of stirring, and the excess of sulfur. At 110 °C the reaction is complete after 1–2 h. Increased pressure with higher reaction temperatures and shorter reaction times can also be used [128]. A one-step process is also possible. Solutions containing ca. 60% ammonium thiosulfate are produced to be sold as such, and 70–72% solutions for production of the solid salt. The latter are filtered hot, sometimes with the addition of charcoal. The 60% solutions can be filtered hot or after cooling.

To obtain the salt the filtered solution is cooled to ca. 20–30 °C. The crystallized salt is separated by using sieve-screw centrifuges. Drying must be carried out carefully; a prod-

uct temperature of 50 °C must not be exceeded. The ca. 60% mother liquor is recycled.

Crystalline ammonium thiosulfate tends to cake. It can be rendered free-flowing by the addition of 5–10% anhydrous sodium thiosulfate (ammonium thiosulfate 90/10). The stability to storage is increased by the addition of ca. 1–2%  $\text{Na}_2\text{SO}_3$ . The stability to storage of ammonium thiosulfate solutions can be increased by adding  $(\text{NH}_4)_2\text{SO}_3$  or  $\text{Na}_2\text{SO}_3$ .

Ammonium thiosulfate can also be produced by the reaction of ammonium polysulfide solutions with gaseous  $\text{SO}_2$  [129, 130]. In a process developed by the company Foret  $(\text{NH}_4)_2\text{S}_2\text{O}_3$  is obtained from  $\text{H}_2\text{S}$ ,  $\text{NH}_3$ , and water at  $\leq 45$  °C in the first step and subsequent reaction with  $\text{SO}_2$  [130, 131].

**Quality Specifications and Analysis.** Commercially the degrees of purity and analysis methods laid down in the ASA, DIN, and ISO standards are valid [124–126] (Table 55.7). In some cases particle size and particle-size distribution are also specified.

Table 55.7: Specifications for photo-quality ammonium thiosulfate.

| Analysis                                      | Solid (ASA) | Aqueous solution (DIN 19080 T82, ISO 3619) |
|---|-------------|--|
| $(\text{NH}_4)_2\text{S}_2\text{O}_3$ , %     | $> 97$      | 57–61                                      |
| Sulfite (as $\text{SO}_3$ ), %                | $\leq 14$   | $\leq 0.7$                                 |
| Sulfite [as $(\text{NH}_4)_2\text{SO}_3$ ], % |             | max. 1                                     |
| $\text{H}_2\text{O}$ , %                      | $\leq 0.5$  | —  |
| $(\text{NH}_4)_2\text{S}$ , ppm               | $\leq 10$   | $\leq 5$                                   |
| Insolubles, %                                 | $\leq 4$    | $\leq 0.2$                                 |
| Combustion residue, %                         | $\leq 2$    | $\leq 0.2$                                 |
| Heavy metals (as Pb), ppm                     | $\leq 20$   | $\leq 10$                                  |
| Iron, ppm                                     | $\leq 50$   | $\leq 10$                                  |

Titration with iodine solution gives the combined thiosulfate and sulfite content; titration in the presence of formaldehyde gives the thiosulfate content.

**Uses.** Ammonium thiosulfate is used almost exclusively as a photographic fixing salt. Its advantage compared with sodium thiosulfate lies in the shorter fixing times, the increase in the efficiency of the fixing baths by ca. 50%, and shorter washing periods. The recovery of the silver from spent fixing baths is easier. In

Western Europe almost only ammonium thiosulfate is now used for fixing. By far the greatest proportion of the demand is covered by solutions.

The following are commercially available as solids:

|                      |   |
|----------------------|---|
| Ammonium thiosulfate | 98/100  |
| Ammonium thiosulfate | 90/10   |
| Rapid fixing salt U3 | 70% $(\text{NH}_4)_2\text{S}_2\text{O}_3$<br>20% $\text{Na}_2\text{S}_2\text{O}_3$<br>10% $\text{Na}_2\text{S}_2\text{O}_3$ |

Some producers of ammonium thiosulfate in Europe are: Th. Goldschmidt; Chemiewerk Bad Köstritz, Germany; Foret, Spain; W. Blythe & Co., United Kingdom.

### 55.10.4 Toxicology

For sodium thiosulfate, the LDLo for subcutaneous application in rabbits is 4000 mg/kg, and in frogs 6000 mg/kg [132].

For  $\text{Na}_2\text{S}_2\text{O}_3 \cdot 5\text{H}_2\text{O}$ , the oral TDLo in humans is 300 mg/kg (oral intake during 7 days). For dogs, the intravenous LDLo is 3000 mg/kg [132].

According to [133],  $\text{Na}_2\text{S}_2\text{O}_3 \cdot 5\text{H}_2\text{O}$  has low oral toxicity. Larger doses (up to 12 g daily) have a severe laxative effect.

The following values have been determined for ammonium thiosulfate [132]: LD<sub>50</sub> (oral, rat) 2890 mg/kg, LD<sub>50</sub> (oral, guinea pig) 1098 mg/kg.

## 55.11 Sodium Dithionite [134]

### 55.11.1 Introduction

Sodium dithionite,  $\text{Na}_2\text{S}_2\text{O}_4$ , is the only industrially important salt of dithionous acid ( $\text{H}_2\text{S}_2\text{O}_4$ ), which has not been isolated. The importance of sodium dithionite lies in its powerful reducing capacity, which allows, for example, vat dyes to be reduced at room temperature. It is also used as a bleaching agent, mainly in the textile and paper industries.

STAHL first prepared dithionite unwittingly in 1718 when he treated iron with aqueous sulfur dioxide and obtained a yellow solution. In 1789 BERTHELOT showed that no hydrogen was produced in this reaction. In 1852 SCHÖNBEIN

used this solution for the reduction of indigo. SCHÜTZENBERGER isolated dithionite as the dihydrate and gave it the name hydrosulfite. In 1881 BERNTHSEN established that hydrosulfite did not contain any hydrogen, but corresponded to the formula  $\text{Na}_2\text{S}_2\text{O}_4$ . In 1905 BAZLEN introduced the zinc-dust process for the production of anhydrous sodium dithionite. He also suggested using sodium amalgam as reducing agent.

### 55.11.2 Properties

Sodium dithionite is known as the dihydrate  $\text{Na}_2\text{S}_2\text{O}_4 \cdot 2\text{H}_2\text{O}$  and as the anhydrous salt. The dihydrate crystallizes in thin, yellowish shiny, soft prisms of density  $1.58 \text{ g/cm}^3$ . The anhydrous salt forms monoclinic white crystals of density  $2.38 \text{ g/cm}^3$ . The solubility in water of both forms is shown in Figure 55.11. Solutions with anhydrous undissolved solute are labile below  $72^\circ\text{C}$ . The solubility and the position of the transformation point are strongly influenced by foreign salts, particularly sodium salts, and water-miscible organic solvents.

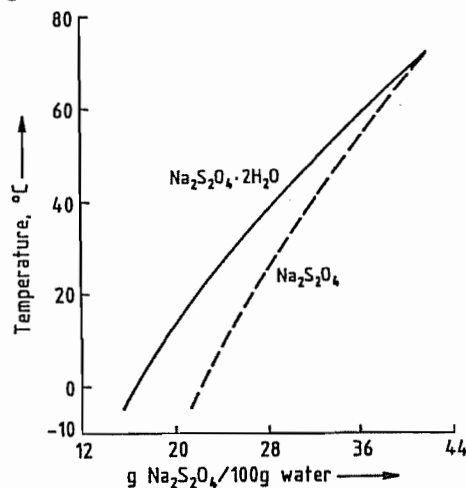
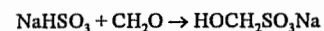
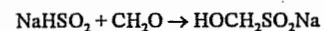
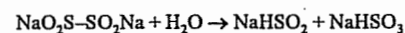

Figure 55.11: Solubility of sodium dithionite in water.

Sodium dithionite dihydrate is very sensitive toward atmospheric oxygen in the finely crystalline state. The heat of oxidation can lead to ignition. The anhydrous salt decomposes exothermically in air on prolonged heat-

ing above  $90^\circ\text{C}$ . The main decomposition products are sodium sulfate and sulfur dioxide. Above ca.  $150^\circ\text{C}$ , with exclusion of air, sodium dithionite decomposes in a vigorous reaction, giving mainly sodium sulfite, sodium thiosulfate, sulfur dioxide, and a small amount of sulfur. In the absence of air, moisture only causes a small degree of decomposition. Sodium dithionite in powder form can decompose in air on contact with a small amount of water with such intense heat formation that it burns with a flame.

Aqueous dithionite solutions decompose slowly in the cold and rapidly in the warm, whereby hydrolysis to hydrogensulfoxylate and hydrogensulfite occurs first. The hydrolysis products can be trapped as sodium 1-hydroxyalkanesulfinates and 1-hydroxyalkanesulfonates by addition of aldehydes or ketones:



In weakly acidic solution dithionite decomposes rapidly, especially under warm conditions, to give the thiosulfate and disulfite or hydrogensulfite, and in alkaline solution to give the sulfide and sulfite:

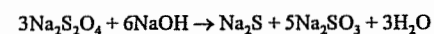
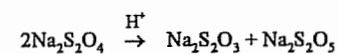

The decomposition in alkaline solution is accelerated by thiosulfates and polysulfides. On addition of strong acids the dithionite solution first becomes yellow-red, and after a short time complete decomposition occurs with precipitation of sulfur. The dithionite can be recovered if the solution is rapidly neutralized before the sulfur precipitates. Weak alkalis (pH 8–13) stabilize dithionite solutions, which can then be kept for weeks below  $10^\circ\text{C}$  with the exclusion of air. In the presence of air the dissolved dithionite is converted rapidly into sulfate and sulfite at room temperature, with or without stabilizer.

The industrial applications of sodium dithionite are determined by its strong reduc-

ing properties, due to the S–S bond and the oxidation state of the sulfur in the compound.

With relatively strong oxidizing agents, such as potassium permanganate and iodine, sulfate is formed; with weaker ones, such as vat dyes, sulfite is formed. With  $\text{MnO}_2$ , dithionate can be formed.

### 55.11.3 Production

All processes for the production of dithionite start with the reduction of sulfurous acid, which can either be present in the free form or as hydrogensulfite. The production processes with zinc dust, sodium amalgam, sodium formate, sodium borohydride, and electric current as the reducing agent are important industrially.

**Zinc-Dust Process.** Some important producers still use the zinc-dust process, which was developed by BASF. The basic reactions are:

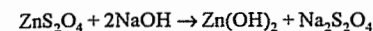
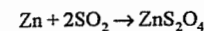

An aqueous slurry of zinc dust is treated in a stirred reactor with cooling at ca.  $40^\circ\text{C}$  with liquid or gaseous sulfur dioxide to give zinc dithionite. After completion of the reaction the solution is passed through a filter press to remove unreacted zinc dust and impurities from the zinc.

The zinc is then precipitated from the zinc dithionite by adding sodium carbonate or sodium hydroxide in stirred vessels. The zinc carbonate or hydroxide is removed in filter presses. Anhydrous sodium dithionite is precipitated from the clarified sodium dithionite solution by concentration under vacuum and addition of sodium chloride at  $> 60^\circ\text{C}$ . It is filtered, washed with methanol, and dried at  $90\text{--}100^\circ\text{C}$ .

Besides the evaporation process the salting out process, which was more widely used previously, is still known. In this process the dithionite is obtained from the solution by the addition of sodium chloride and methanol.

The zinc carbonate or hydroxide formed as side products can be further processed to give zinc salts or zinc oxide.

**Amalgam Process.** In the amalgam process, sodium hydrogensulfite is reduced to sodium dithionite in aqueous solution in a cooled, stirred vessel using the sodium amalgam of a chlor-alkali electrolysis cell. The sodium-free mercury is returned to the electrolysis cell where it is recharged with sodium. During reaction of the amalgam with the hydrogensulfite solution a pH of 5–6 must be maintained. The product is obtained by precipitation with salts or methanol or both.

**Formate Process** [135]. Sodium formate, dissolved in 80% aqueous methanol, is charged to a stirred vessel. At a pressure of 2–3 bar sulfur dioxide and sodium hydroxide are introduced into this solution such that a pH of 4–5 is maintained. The reaction can be described by the following equation:

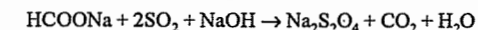

Under the above conditions anhydrous sodium dithionite precipitates as fine crystals. It is filtered, washed with methanol, and dried.

**Sodium Borohydride Process.** Sodium borohydride is stable in strong aqueous alkali and can be used in this form for the production of sodium dithionite by adding  $\text{SO}_2$  and sodium hydroxide:

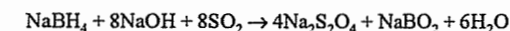

**Electrolytic Process** [136]. The electrolytic process, developed by BASF and by Olin, is used in only one small plant.

In a bipolar electrolysis cell, with the cathode and anode spaces separated by a semipermeable membrane, disulfite ions are reduced to dithionite at the cathode at pH 5–6. At the anode chloride ions, for example, are oxidized to chlorine. For charge equalization sodium ions pass through the membrane from the anode space to the cathode space. This process gives a dithionite solution which can be further processed as in the amalgam process.

### 55.11.4 Quality Specifications and Analysis [137]

Commercial sodium dithionite generally has a purity of ca. 88%. It contains ca. 3% of

each of the following: sodium disulfite, sodium sulfite, sodium sulfate, and sodium carbonate. The latter stabilizes the  $\text{Na}_2\text{S}_2\text{O}_4$ . The total heavy metal content is generally < 20 ppm. The product from the zinc-dust process has a zinc content of up to 300 ppm.

The sodium dithionite content can most readily be determined iodometrically. It is dissolved in a neutral formaldehyde solution in a standard flask. The dithionite, which is sensitive to oxidation, reacts immediately on dissolving to give the more stable sodium hydroxymethanesulfinate, which can be titrated.

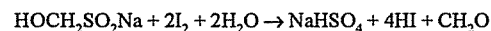
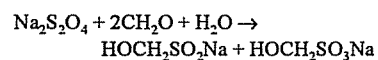

However, this method of analysis does not differentiate between dithionite and any thiosulfate which may be present. Since no acid is formed in the iodometric oxidation of thiosulfate, but is formed in the dithionite titration, the proportion of dithionite can be determined by subsequent titration of the solution with alkali.

### 55.11.5 Trade Names and Uses

Sodium dithionite is sold as the 88% product, for example, under the names Hydrosulfit (BASF, Brüggemann, Germany; Prayon, Belgium; Hoechst-Celanese, USA; Hoechst-UK, UK, etc.), Blankit (BASF), Albite A (Idrosol, Italy), and Konite (Akzo, Holland). Hydrosulfit mixtures are sold, for example, under the names Blankit (with index, BASF), Blancolen (Brüggemann, Germany), Albite LA (Idrosol, Italy), Konite TP (Akzo, Holland), Zepar (Du Pont), Burmol (BASF), Arostit (Sandoz).

All uses of sodium dithionite are based on its reducing properties. It is used predominantly in the textile industry as a dyeing and printing auxiliary and as a bleaching agent in the textile and paper industries.

In dyeing and printing, sodium dithionite is used to convert insoluble vat dyes to the soluble leuco form. High-purity sodium dithionite (e.g., Blankit) is used to bleach wool, cotton,

silk, bristle, straw, horsehair, coconut fiber, raffia, soaps, glues, clay, sand, bauxite, and in some countries for bleaching sugar, syrup, fruit, edible oils, edible fats, and gelatin.

For special applications in the paper or textile industries complexing agents such as trilon or phosphates, or also optical brighteners are added to dithionite-containing products.

The reducing action of sodium dithionite is also used in preparative and analytical chemistry. It can reduce azo, diazo, nitro, nitroso, and carbonyl groups.

### 55.11.6 Safety and Environmental Aspects; Storage and Transport

Above a certain dithionite concentration, mixtures in powder form decompose if subjected to prolonged exposure to high temperatures or come into contact with water. In the case of very finely divided products this decomposition can already occur at 80 °C. Product that is decomposing must be covered immediately with dry sand or powder extinguisher, or dissolved by shovelling into large quantities of water. If sodium dithionite packed in iron drums ignites, the  $\text{SO}_2$  gas produced must be allowed to escape by opening the container or drilling holes in the wall. The contents of the container are destroyed by throwing them into large quantities of water. The aqueous solution thus formed must be treated as it contains reducing agent and must be slowly introduced into an appropriate wastewater-treatment plant. Gloves and respiratory protection must be worn while extinguishing fires.

Dithionite is classified in the German water hazard class 1 as posing a slight hazard to water.

The wastewater from all production processes contains approximately equal quantities of reducing agent, which must be removed in a wastewater-treatment plant. The  $\text{CO}_2$  formed in the formate process (Section 55.11.3) must be freed from  $\text{SO}_2$ , methanol, and thiols before being released into the atmosphere.

Commercial sodium dithionite (e.g., Hydrosulfit and various product mixtures, which contain Hydrosulfit) are spontaneously combustible hazardous goods (Class 4.2, UN no. 1384), and are therefore subject to the corresponding transport regulations [138–142].

Because of the danger of spontaneous ignition sodium dithionite and its mixtures must be stored dry and in a cool place. Storage or transport together with sodium nitrite, sodium nitrate, and ammonium nitrate is forbidden. Transport containers must always be kept closed. Product should only be removed in a dry area using dry equipment.

### 55.11.7 Economic Aspects

World consumption of sodium dithionite is ca. 300 000 t/a, corresponding to ca. 60% of production capacity. The zinc dust process accounts for ca. 35% of the capacity, the formate process 40%, the amalgam process 15%, and the sodium borohydride process 10%.

### 55.11.8 Toxicology [143]

The  $\text{LD}_{50}$  (rat, oral) is ca. 2500 mg/kg. In the rabbit the product has no irritant effect on the skin, but has an irritant effect on the mucous membrane (rabbit's eye). Therefore, in an emergency or as first aid measures it is sufficient to wash the skin thoroughly with water and to rinse the eyes for 10 min. with running water. An eye specialist should then be consulted.

The 48-h  $\text{LC}_{50}$  in golden orfe is 10–100 mg/L.

## 55.12 References

1. R. Steudel, *Angew. Chem.* **87** (1975) no. 19, 683.
2. F. A. Cotton, G. Wilkinson, P. L. Gaus: *Grundlagen der Anorganischen Chemie*, VCH Verlagsgesellschaft, Weinheim 1990, p. 160.
3. *Römpf* 9th ed., 5, 4377.
4. T. G. Pearson, P. C. Robinson, *J. Chem. Soc.* **1930**, 1473.
5. N. K. Gupta, R. P. Tischer, *J. Electrochem. Soc.* **119** (1972) 1033.
6. E. Rosen, R. Tegman, *Chem. Scr.* **2** (1972) 221.
7. D.-G. Oei, *Inorg. Chem.* **12** (1973) 435.
8. D.-G. Oei, *Inorg. Chem.* **12** (1973) 438.
9. B. Cleaver, S. M. Upton, *Electrochim. Acta* **36** (1991) no. 3/4, 673–677.
10. W. Fischer: "Die Natrium-Schwefel-Batterie", *Elektrochem. Energietechn. Entwicklungstrends Ausschichten* **1981**, 185–205.
11. P. Bottcher, *Z. Anorg. Allg. Chem.* **467** (1980) 149–157.
12. F. Fehér, H. J. Berthold, *Z. Anorg. Allg. Chem.* **273** (1953) 144.
13. A. P. Brown, J. E. Battles, *Synth. React. Inorg. Met. Org. Chem.* **14** (1984) no. 7, 945–951.
14. B. Cleaver, S. J. Sime, *Electrochim. Acta* **28** (1983) no. 5, 703–708.
15. N. N. Greenwood, A. Earnshaw: *Chemie der Elemente*, 1st ed., VCH Verlagsgesellschaft, Weinheim 1988, p. 893.
16. G. J. Janz, D. J. Rogers, *J. Appl. Electrochem.* **13** (1983) 121–131.
17. B. Warnqvist, *Thermochim. Acta* **37** (1980) 343–345.
18. R. Tegman, *Chem. Scr.* **9** (1976) 158–166.
19. E. Rosén, *K. Tek. Hoegsk. Handl.* (1960) 159.
20. E. Rosén, *Sven. Kem. Tidskr.* **76** (1964) 195.
21. H. Föppel, E. Busmann, F.-K. Frorath, *Z. Anorg. Allg. Chem.* **314** (1962) 12.
22. J. S. Thomas, A. Rule, *J. Chem. Soc.* **105** (1914) 177.
23. R. Tegman, *Acta Crystallogr. Sect. B: Struct. Sci.* **B29** (1973) 1463.
24. R. Steudel, F. Schuster, *Z. Naturforsch. A: Phys. Phys. Chem. Kosmophys.* **32A** (1977) 1313–1319.
25. H. H. Eysel, G. Wiegardt, H. Kleinschmagger G. Weddigen, *Z. Naturforsch. B: Anorg. Chem. Org. Chem.* **31B** (1976) 415.
26. H. Köpf, B. Block, *Chem. Ber.* **102** (1969) 1504–1508.
27. T. P. Whaley in A. F. Trothman-Dickenson (ed.): *Comprehensive Inorganic Chemistry*, vol. 2, Pergamon Press, Oxford 1973, p. 369.
28. B. Cleaver, A. J. Davies, M. D. Hames, *Electrochim. Acta* **18** (1973) 719–726.
29. B. Cleaver, A. J. Davies, *Electrochim. Acta* **18** (1973) 727–731.  
B. Cleaver: "Properties of Polysulfide Melts", in R. P. Tischer (ed.): *The Sulfur Electrode Fused Salts and Solid Electrolytes*, vol. II, Academic Press, New York 1983, pp. 36–78.
30. *Mellor's Comprehensive Treatise on Inorganic and Theoretical Chemistry*, vol. II, suppl. II, part I, Longman Group Ltd., London 1961, p. 991.
31. *Gmelin*, **21**, 1049.
32. *Kirk-Othmer*, 3rd ed., **21**, 256.
33. *Ullmann*, 4th ed., **17**, 167.
34. M. Schmidt, *Inorg. Macromol. Rev.* **1** (1970) 101–113.
35. M. Schmidt, W. Siebert: "Sulfane", in *Comprehensive Inorganic Chemistry*, vol. 2, sect. 2.1, Pergamon Press, Oxford 1973, pp. 826–842.
36. A. Müller, E. Diemann, *Adv. Inorg. Chem. Radiochem.* **31** (1987) 89.
37. L. Hockenberger, *Chem. Ing. Tech.* **36** (1964) no. 10, 1046.
38. T. B. Rauchfuss, M. Draganjac, *Angew. Chem.* **97** (1985) 745–760.
39. Degussa, US 4640832, 1985.

40. Degussa, US 5080881, 1989.
41. Degussa, US 5075098, 1990.
42. Degussa, US 5039506, 1990.
43. Degussa, US 5039505, 1990.
44. I. G. Farbenind., DE 590278, 1933 (E. Reißmann, H. Wolff).
45. Thiokol Chem. Corp., US 2796325, 1951 (E. R. Bertozzi).
46. Winnacker-Küchler: *Chemische Technologie*, 4th ed., 2, 83.
47. Kali-Chemie, DE 842789, 1950.  
TH. Goldschmidt, DE 920010, 1949.  
R. Botson, US 1736741, 1927.  
I. G. Farbenind., DE 499417, 1925.
48. Bayer, DE 1016242, 1958 (H. Beyer).
49. Sankyo Kasei, EP 0361998 A1, 1990 (Maeda, Kanosuke).
50. Verein. Chem. Fabr. Mannheim, DE, 194882, 1907.
51. Degussa, DE-AS 1084701, 1959.
52. BASF, DE-AS 1122045, 1960.
53. BASF, DE-AS 1102114, 1959.
54. Bayer, DE 814140, 1949.
55. Solvay Process, US 2376433, 1944; US 2376434, 1944; US 2376435, 1944.
56. Deutsche Erdöl-AG, DE-AS 1144241, 1961.
57. J. L. Sudworth, A. R. Tilley: "The Sodium-Sulfur Battery with  $\beta$ -Alumina Electrolyte", in R. P. Tischer (ed.): *The Sulfur Electrode Fused Salts and Solid Electrolytes* vol. VII, Academic Press, New York 1983, pp. 235-325.
58. Winnacker-Küchler, *Chemische Technologie*, 4th ed., 7, 41.  
*Kirk-Othmer*, 3rd ed., 22, 168.
59. U. Deschler, P. Kleinschmit, P. Panster, *Angew. Chem.* 98 (1986) 237-253.
60. Degussa AG, Geschäftsbereich AC; Company brochures:  
„Organosilane für die Gummiindustrie“ Jan. 1994/Nr. 6000.0.  
Schriftenreihe Pigmente, Nr. 75, „Degussa-Silane“ Fig. 75-2-3-1087 DD, Okt. 1987.  
„Si 69X 50-SX50“ Verstärkungsadditiv Information für die Gummiindustrie PT68-2-3-691 Ha.
61. *Kirk-Othmer*, 3rd ed., 18, 793.
62. *Ullmann*, 5th ed., 21, 429.
63. H. Cherdron, F. Herold, A. Schneller, *Chem. Unserer Zeit* 23 (1989) no. 6, 181.
64. W. Koch, W. Heitz, *Makromol. Chem.* 184 (1983) 779-792.
65. *Kirk-Othmer*, 3rd ed., 18, 793.
66. Société nationale des pétroles d'Aquitaine, DE 2157575, 1972 (J. B. Signouret, Y. Labat, C. Esclamadon).
67. Société nationale Elf Aquitaine S.A., DE 2757148, 1978.
68. J. Kausch, DD 156709, 1982.
69. K. Negoro, T. Watanabe, *Nippon Gomu Kyokaishi* 43 (9), 743-752; *Chem. Abstr.* 73 (1970) 121333b.
70. Toray Industries, JP 46014671, 1971 (S. Tanemoto, M. Takahashi).
71. W. Schulz, Universität Frankfurt/Main 1979, Ph. D. Thesis: "Untersuchungen an Verbindungen mit verschiedenartigen Sulfidbrücken".
72. W. F. Giggenbach, *Inorg. Chem.* 13 (1974) 1730.
73. W. F. Giggenbach, *Inorg. Chem.* 13 (1974) 1724.
74. R. Steudel, G. Holdt, R. Nagorka, *Z. Naturforsch. B: Anorg. Chem. Org. Chem.* 41B (1986) 1519-1522.
75. M. B. Berenbaum: *Encyclopedia of Polymer Science and Technology*, vol. 11, Wiley-Interscience, pp. 425-447.
76. G. Wilhelm, *Adhäsion* 5 (1976) 156.
77. Dow Chemical, US 4438259, 1984 (V. E. Meyer, T. E. Dergazarian).
78. Winnacker-Küchler, *Chemische Technologie*, 4th ed., 6, 2.14.
79. Henkel, DE 3604793 A1, 1986 (G. Borggreffe).
80. *Ullmann*, 4th ed., 20, 552.
81. E. Cooper, EP 32281, 1981 (A. G. Papay, J. P. O'Brien).
82. Mobil Oil, EP 7735, 1980 (A. G. Horodysky, S. Landis).
83. Lubrizol, US 4119549, 1978 (K. E. Davis).
84. E. Cooper, US 4563302 A, 1986 (P. G. Griffia, W. Y. Lam).
85. Mobil Oil, US 4123372, 1978 (R. F. Bridger, P. S. Landis).
86. Institut français du pétrole, FR 2588881 A1, 1987 (M. Born, L. Briquet, G. Parc).
87. Lubrizol, US 86838234, 1986 (C. P. Bryant, S. Q. A. Rizvi, K. B. Grover, J. N. Vinci).
88. Phillips Petroleum, US 3759956, 1973 (P. R. Strapp).
89. A. M. Kuliev, F. I. Gasanov, F. N. Mamedov, *Prisadki Smaz. Maslam* 2 (1969) 27-9; *Chem. Abstr.* 72 (8) 33982m.
90. A. M. Kuliev, K. I. Sadykhov, R. K. Mamedova, N. S. Kerimov, S. M. Abutalybova, *Azerb. Neft. Khoz.* 53 (1973) 40; *Chem. Abstr.* 80 (10) 50087f.
91. Magyar Asvanyolai És Foldgaz Kiserleti Intezet, GB 2193957 A1, 1988 (R. Csikos, S. Borzsonyi, P. L. Farkas).
92. R. Böttcher, S. Wartewig, W. Windisch, A. Zschunke, *Z. Naturforsch. A: Astrophys. Phys. Phys. Chem.* 23A (1968) 1766-1770.
93. Toyo Soda Mfg., JP 55071761, 1980; *Chem. Abstr.* 93 (16) 151794h.
94. F. Seel, H. J. Güttler, *Angew. Chem.* 85 (1973) 416.
95. F. A. Cotton, J. B. Harmon, R. M. Hedges, *J. Am. Chem. Soc.* 98 (1976) 1417.
96. Nitto Chemical Industry Co., JP 50060050, 1975 (I. Watanabe); *Chem. Abstr.* 83 (12) 102984w.
97. Yuasa Battery, JP 56058 582, 1981; *Chem. Abstr.* 95 (16) 138034g.
98. F. Holdinghausen, D. Männig, R. Wenzl, company report, Degussa AG, Frankfurt/Main 1994.
99. Gefahrstoffverordnung, 4th ed., 12/1993, Deutscher Bundes-Verlag, Bonn 1993.
100. Kühn-Birret-Merkblätter, 13. Erg.-Lfg. 11/80-N 19-2, Ecomed Verlagsgesellschaft, Landsberg.
101. Roth-Weller: *Sicherheitsfibel Chemie*, 5th ed., Ecomed-Verlag, Landsberg/Lech 1991.
102. Daten Chemischer Stoffe, 28. Erg.-Lfg. 12/92, Ecomed-Verlag, Landsberg/Lech 1992.
103. Wasserhaushaltsgesetz (WHG) in der Fassung der Bekanntmachung vom 23. Sept. 1986, Bundesgesetzblatt I, p. 1529.
104. Degussa AG: brochure "Umwelt und Degussa" no. CH 460 4-05-290 and leaflet no. CH 337-3-05491, Degussa AG, Hanau 1991.
105. Allgemeine Rahmen-Verwaltungsvorschrift über Mindestanforderungen an das Einleiten von Abwasser (Rahmen-Abwasser-VwV) in Gewässer, Gemeinsames Ministerialblatt Nr. 25 vom 22. Sept. 1989.
106. H. W. Sonntag, company report, Degussa AG, Frankfurt/Main 1994.
107. R. Neureiter, Degussa AG, company information, Frankfurt/Main 1994.
108. G. Nickless: *Inorganic Sulfur Chemistry*, Elsevier, Amsterdam 1968, pp. 509-533.
109. *Gmelin*, system no. 23, Ammonium, 1936, 256-259.
110. *Gmelin*, system no. 22, Kalium, 1938, 702-708.
111. *Gmelin*, system no. 21, Natrium, 1928, 515-535; suppl. 1964-1970, 205-213, 1079-1090, 1876.
112. F. Foerster et al., *Z. Phys. Chem. (Leipzig)* 110 (1924) 435-496.
113. Hoechst, DE-OS 2221298, 1973 (W. Schreiber, A. Metzger, J. Scholderer).
114. BASF, DE-OS 1186450, 1965 (W. Spormann, J. Heinke).
115. BASF, DE-OS 1809507, 1970 (W. Spormann).
116. Allied Chem., DE-OS 2611190, 1976 (S. L. Bean).
117. M. W. Wirth: *Toxikologiefibel*, Thieme Verlag, Stuttgart 1962.
118. H. V. Benda, *Z. Naturforsch. B Anorg. Chem. Org.* 34B (1979) 957-968.
119. *Gmelin*, system no. 21, 3rd ed., 1162-1176.
120. *Chem. Abstr.* 99 no. 20, 160805p.
121. *Chem. Abstr.* 104 no. 10, 71120r.
122. *Chem. Abstr.* 110 no. 10, 78885b; *Chem. Abstr.* 111 no. 12, 99852z.
123. *Chem. Abstr.* 82 no. 12, 77551f; *Chem. Abstr.* 82, no. 4, 19032b.
124. American Standards Association INC., Specifications PH 4, New York 1960, pp. 250-251.
125. ISO Norm 3619, 1976.
126. DIN 19080, Part 82, August 1978.
127. Th. Goldschmidt, DT 1184330, 1963; DT 1265146, 1966.
128. Allied Chem., CA 82159, 1967.
129. *Chem. Abstr.* 70 no. 20, 89265f.
130. *Chem. Abstr.* 80 no. 14, 72539g.
131. *Chem. Abstr.* 107 no. 20, 179463f.
132. NIOSH: *Registry of Toxic Effects of Chemical Substances*, Cincinnati 1983.
133. W. Braun, *Vergiftungsfibel*, Thieme Verlag, Stuttgart 1980.
134. M. Schmidt, W. Siebert: *Comprehensive Inorganic Chemistry*, vol. 2, Pergamon Press, Oxford 1973, p. 881.  
G. Nickless: *Inorganic Sulfur Chemistry*, Elsevier, Amsterdam 1968, p. 519.
135. Mitsubishi Edogawa, DE 1592013, 1978 (Y. Yoshikawa, H. Okazaki, T. Yamaguchi).  
BASF, DE-AS 2442418, 1974 (E. Voelkl et al.).
136. BASF, DE 2646825, 1976 (B. Leutner et al.).  
Olin Corporation, US 4836903, 1989 (D. W. Cawfield).
137. G. Nickless: *Inorganic Sulfur Chemistry*, Elsevier, Amsterdam 1968, pp. 220, 227.
138. Bundesgesetz Blatt 11, p. 838 (1990).
139. Bundesgesetz Blatt 1, p. 1001 (1990).
140. Bundesgesetz Blatt 1, p. 860 (1992).
141. Bundesgesetz Blatt 1, p. 1714 (1991).
142. Bundesgesetz Blatt 1, p. 1221 (1990).
143. BASF: safety data sheets, 1983.



## Part Thirteen

### Alkaline Earth Metals

|    |    |                 |    |    |    |    |    |    |    |    |    |    |    |    |    |    |    |    |    |   |    |    |    |
|----|----|-----------------|----|----|----|----|----|----|----|----|----|----|----|----|----|----|----|----|----|---|----|----|----|
|    |    |                 |    |    |    |    |    |    |    |    |    |    |    |    |    |    |    | H  | He |   |    |    |    |
| Li | Be |                 |    |    |    |    |    |    |    |    |    |    |    |    |    |    |    | B  | C  | N | O  | F  | Ne |
| Na | Mg | Al              |    |    |    |    |    |    |    |    |    |    |    |    |    |    |    | Si | P  | S | Cl | Ar |    |
| K  | Ca | Sc              | Ti | V  | Cr | Mn | Fe | Co | Ni | Cu | Zn | Ga | Ge | As | Se | Br | Kr |    |    |   |    |    |    |
| Rb | Sr | Y               | Zr | Nb | Mo | Tc | Ru | Rh | Pd | Ag | Cd | In | Sn | Sb | Te | I  | Xe |    |    |   |    |    |    |
| Cs | Ba | La <sup>†</sup> | Hf | Ta | W  | Re | Os | Ir | Pt | Au | Hg | Tl | Pb | Bi | Po | At | Rn |    |    |   |    |    |    |
| Fr | Ra | Ac <sup>‡</sup> |    |    |    |    |    |    |    |    |    |    |    |    |    |    |    |    |    |   |    |    |    |

|   |    |    |    |    |    |    |    |    |    |    |    |    |    |    |
|---|----|----|----|----|----|----|----|----|----|----|----|----|----|----|
| † | Ce | Pr | Nd | Pm | Sm | Eu | Gd | Tb | Dy | Ho | Er | Tm | Yb | Lu |
|---|----|----|----|----|----|----|----|----|----|----|----|----|----|----|

|   |    |    |   |    |    |    |    |    |    |    |    |    |    |    |
|---|----|----|---|----|----|----|----|----|----|----|----|----|----|----|
| ‡ | Th | Pa | U | Np | Pu | Am | Cm | Bk | Cf | Es | Fm | Md | No | Lr |
|---|----|----|---|----|----|----|----|----|----|----|----|----|----|----|

For Beryllium and Magnesium, see *Light Metals*.  
For Radium, see *Radioactive Metals*.

## 56 Calcium

STEPHEN HLUCHAN (§§ 56.1–56.4); JOSEPH A. H. OATES (§ 56.5); FRANZ WIRSCHING (§ 56.6); SUZANNE E. KEEGAN, ROBERT KEMP (§ 56.7); PETER FORGIONE (§ 56.8)

|          |   |      |          |   |      |
|----------|---|------|----------|---|------|
| 56.1     | Introduction                                  | 2250 | 56.6.3   | Production  | 2291 |
| 56.2     | Properties                                    | 2250 | 56.6.3.1 | <i>Natural Gypsum to Calcined Products</i>                                | 2291 |
| 56.3     | Production                                    | 2250 | 56.6.3.2 | <i>FGD Gypsum to Calcined Products</i>                                    | 2297 |
| 56.4     | Uses  | 2251 | 56.6.3.3 | <i>Phosphogypsum to Calcined Products</i>                                 | 2299 |
| 56.5     | Lime and Limestone                            | 2252 | 56.6.3.4 | <i>Anhydrite Plaster</i>  | 2301 |
| 56.5.1   | Introduction                                  | 2252 | 56.6.4   | Use and Properties of Gypsum Plasters and Products and Anhydrite Plasters | 2301 |
| 56.5.2   | Limestone                                     | 2255 | 56.6.4.1 | <i>Hydration, Setting, Hardening</i>                                      | 2301 |
| 56.5.2.1 | <i>Physical and Chemical Properties</i>       | 2255 | 56.6.4.2 | <i>Prefabricated Gypsum Building Components</i>                           | 2304 |
| 56.5.2.2 | <i>Formation and Occurrence</i>               | 2256 | 56.6.4.3 | <i>Gypsum Plaster</i>   | 2305 |
| 56.5.2.3 | <i>Production</i>                             | 2256 | 56.6.4.4 | <i>Other Uses</i>   | 2306 |
| 56.5.2.4 | <i>Uses and Specifications</i>                | 2257 | 56.6.4.5 | <i>Properties of Gypsum Building Products Installed in Situ</i>           | 2308 |
| 56.5.3   | Quicklime                                     | 2258 | 56.6.5   | Material Testing and Chemical Analysis                                    | 2309 |
| 56.5.3.1 | <i>Physical and Chemical Properties</i>       | 2258 | 56.6.5.1 | <i>Standards</i>  | 2309 |
| 56.5.3.2 | <i>Raw Materials</i>                          | 2260 | 56.6.5.2 | <i>Testing</i>  | 2309 |
| 56.5.3.3 | <i>Production</i>                             | 2262 | 56.6.5.3 | <i>Chemical Analysis</i>  | 2310 |
| 56.5.3.4 | <i>Uses and Specifications</i>                | 2269 | 56.6.5.4 | <i>Phase Analysis</i>   | 2310 |
| 56.5.4   | Hydrated and Slaked Lime                      | 2271 | 56.6.6   | Economic Aspects  | 2311 |
| 56.5.4.1 | <i>Physical and Chemical Properties</i>       | 2271 | 56.7     | Calcium Chloride  | 2311 |
| 56.5.4.2 | <i>Raw Materials</i>                          | 2272 | 56.7.1   | Physical Properties   | 2311 |
| 56.5.4.3 | <i>Production</i>                             | 2273 | 56.7.2   | Chemical Properties   | 2313 |
| 56.5.4.4 | <i>Uses and Specifications</i>                | 2274 | 56.7.3   | Production  | 2314 |
| 56.5.5   | Environmental Protection                      | 2276 | 56.7.4   | Environmental Protection  | 2314 |
| 56.5.6   | Physical Testing and Chemical Analysis        | 2277 | 56.7.5   | Quality Specifications  | 2315 |
| 56.5.6.1 | <i>Sampling and Sample Preparation</i>        | 2277 | 56.7.6   | Chemical Analysis   | 2315 |
| 56.5.6.2 | <i>Physical Testing</i>                       | 2278 | 56.7.7   | Storage and Transportation  | 2315 |
| 56.5.6.3 | <i>Chemical Analysis</i>                      | 2278 | 56.7.8   | Uses  | 2316 |
| 56.5.7   | Storage and Transportation                    | 2278 | 56.7.9   | Economic Aspects  | 2317 |
| 56.5.8   | Economic Aspects                              | 2279 | 56.7.10  | Toxicology and Occupational Health  | 2317 |
| 56.5.9   | Toxicology and Occupational Health            | 2280 | 56.8     | Calcium Cyanamide   | 2317 |
| 56.5.9.1 | <i>Toxicology</i>                             | 2280 | 56.8.1   | Physical Properties   | 2317 |
| 56.5.9.2 | <i>Occupational Health</i>                    | 2281 | 56.8.2   | Chemical Properties   | 2318 |
| 56.6     | Calcium Sulfate                               | 2281 | 56.8.3   | Production  | 2318 |
| 56.6.1   | The $\text{CaSO}_4\text{-H}_2\text{O}$ System | 2282 | 56.8.3.1 | <i>Overall Process</i>  | 2318 |
| 56.6.1.1 | <i>Phases</i>                                 | 2282 | 56.8.3.2 | <i>Manufacture</i>  | 2319 |
| 56.6.1.2 | <i>Laboratory Synthesis</i>                   | 2284 | 56.8.3.3 | <i>Processing of Technical Calcium Cyanamide</i>                          | 2322 |
| 56.6.1.3 | <i>Industrial Dehydration of Gypsum</i>       | 2285 | 56.8.4   | Quality Specifications  | 2323 |
| 56.6.1.4 | <i>Energy Aspects</i>                         | 2285 | 56.8.5   | Storage and Transportation  | 2323 |
| 56.6.1.5 | <i>Structure, Mixed Compounds, Solubility</i> | 2286 | 56.8.6   | Uses  | 2323 |
| 56.6.2   | Occurrence, Raw Materials                     | 2287 | 56.9     | References  | 2324 |
| 56.6.2.1 | <i>Gypsum and Anhydrite Rock</i>              | 2287 |          |   |      |
| 56.6.2.2 | <i>Flue-Gas Desulfurization (FGD) Gypsum</i>  | 2288 |          |   |      |
| 56.6.2.3 | <i>Phosphogypsum</i>                          | 2290 |          |   |      |
| 56.6.2.4 | <i>Fluoroanhydrite</i>                        | 2290 |          |   |      |
| 56.6.2.5 | <i>Other By-product Gypsums</i>               | 2291 |          |   |      |

## 56.1 Introduction

Calcium metal was discovered in 1808 independently by SIR HUMPHRY DAVY and by J. J. BERZELIUS and POUTIN. Its name derives from the Latin "calx", for lime. It is the fifth most abundant element in the earth's crust. Some important, naturally occurring compounds are the carbonate (limestone), the sulfate, and complex silicates.

## 56.2 Properties

Calcium, stable isotopes 40, 42, 43, 44, 46, 48, electronic configuration 2-8-8-2, is a silvery white metal. Its major properties are:

|                               |   |
|-------------------------------|---|
| Density (20 °C)               | 1.55                                    |
| Melting point                 | 838 °C                                  |
| Boiling point                 | 1440 °C                                 |
| Specific heat (0-100 °C)      | 0.624 Jg <sup>-1</sup> K <sup>-1</sup>  |
| Heat of fusion                | 217.7 J/g                               |
| Heat of vaporization          | 4187 J/g                                |
| Thermal expansion (0-400 °C)  | 22.3 × 10 <sup>-6</sup> K <sup>-1</sup> |
| Electrical resistivity (0 °C) | 3.91 × 10 <sup>-6</sup> Ωcm             |
| Thermal conductivity (20 °C)  | 1.26 W cm <sup>-1</sup> K <sup>-1</sup> |
| Lattice constant (Fcc)        | 0.5582 nm                               |

Calcium is relatively unstable in moist air, rapidly forming a hydration coating. It can be stored in dry air (less than 30% R.H.) at room temperature. Calcium reacts spontaneously with water to form Ca(OH)<sub>2</sub> and hydrogen gas; when finely divided, it will ignite in air.

One of the alkaline earth group of metals, group IIA, calcium exists in the face centered cubic form at room temperature, transforming to a body centered cubic structure at 448 °C, and melting at 838 °C.

The predominate stable isotope of calcium is <sup>40</sup>Ca. Calcium exhibits only one valence state, 2+, in all of its reactions. It is slightly less active than barium and strontium in the same series. Calcium is a very ductile metal and can be formed by casting, extrusion, rolling, etc. Table 56.1 presents mechanical properties of calcium.

Calcium is noted for its high reactivity, especially the high heat of formation of some of its compounds. Examples are given in Table 56.2. The low density and relatively low-electrical resistivity make calcium one of the most efficient electrical conductors on a mass basis.

Table 56.1: Mechanical properties of calcium metal.

| Mechanical properties                     | Annealed | Cold worked |
|---|----------|-------------|
| Tensile strength, N/mm <sup>2</sup>       | 4800     | 11 500      |
| Yield strength, N/mm <sup>2</sup>         | 1370     | 8500        |
| Elongation, %                             | 51       | 7           |
| Modulus of elasticity, MN/mm <sup>2</sup> | 2.2-2.6  |             |
| Hardness, Rockwell B                      | 16-18    |             |

Table 56.2: Heats of formation ΔH<sub>f</sub> of calcium compounds.

| Compound          | ΔH <sub>f</sub> , kJ/mol | Compound                       | ΔH <sub>f</sub> , kJ/mol |
|-------------------|--------------------------|--------------------------------|--------------------------|
| CaBr <sub>2</sub> | -675.3                   | Ca <sub>3</sub> N <sub>2</sub> | -432.1                   |
| CaCl <sub>2</sub> | -795.5                   | CaO                            | -636.0                   |
| CaF <sub>2</sub>  | -1215.4                  | CaO <sub>2</sub>               | -659.4                   |
| CaH <sub>2</sub>  | -188.8                   | Ca <sub>3</sub> P <sub>2</sub> | -504.5                   |
| CaI <sub>2</sub>  | -535.1                   | CaS                            | -482.7                   |

## 56.3 Production

Calcium is produced in the United States by Minteq Int'l Inc. at Canaan, Connecticut; in Canada by Timminco Ltd; and in France by Pechiney. Prior to World War II, the major production method was electrolysis of fused calcium chloride, but this method has been discontinued. The world capacity is 8000 t/a. The United States accounts for over 50% of the world's consumption of calcium. Total world capacity utilization is under 65%; pricing has been stable.

The process used today is thermal reduction of lime with aluminum. The reactants, lime and aluminum powder, are briquetted and charged into a high-temperature alloy retort. The reaction vessel is evacuated to 0.1 Pa or less; it is then heated to 1200 °C. The aluminum reduces the lime producing calcium metal vapor. The calcium then is removed from the reaction by condensation, thus allowing the reaction to continue in the desired direction.

High-purity grade calcium metal requires highly purified lime and aluminum. A further vacuum distillation step is also required because the calcium produced in the reduction reaction is contaminated with aluminum. In addition this second operation reduces the level of other contaminants, such as manganese. Table 56.3 shows the purity after both the first and the second purification steps.

Table 56.3: Chemical analysis of typical commercial and redistilled calcium.

| Element   | Commercial grade, % | Redistilled grade, % |
|-----------|---------------------|----------------------|
| Mg        | 0.50                | 0.50                 |
| N         | 0.08                | 0.02                 |
| Al        | 0.30                | 0.001                |
| Fe        | 0.008               | 0.001                |
| Mn        | 0.01                | 0.002                |
| Co        | —                   | 0.0002               |
| Li        | —                   | 0.0001               |
| Be        | —                   | 0.0001               |
| Cr        | —                   | 0.0002               |
| B         | —                   | 0.0001               |
| Ca and Mg | 99.5                | 99.9                 |

## 56.4 Uses

Calcium is used in the production of energy-efficient materials: high-strength steels, maintenance free automotive batteries, and advanced magnetic materials.

The major use of calcium is to improve the quality of steel. For decades, calcium containing ferroalloys have been used as tap stream additions to the molten metal, or calcium compounds were injected through a refractory lance using argon, a carrier gas. Although the benefits of using pure calcium metal were known, they were difficult to obtain; calcium is highly volatile, boiling well below steel-making temperatures.

In the early 1970s, wire feeding technology was introduced. A steel clad calcium wire is fed through a delivery system which propels the wire well below the surface of the molten steel. The steel cladding protects the calcium until it reaches a depth where the ferrostatic pressure suppresses the vaporization. Systems have been developed for ladle, tundish, and degasser application. For large tonnage use, a wire-lance system combines the advantages of wire feeding, gas control of fluid dynamics, and treatment with pure calcium. This has resulted in the efficient production of improved quality ultraclean steels.

Calcium is important in steel chemistry because it is a strong oxide and sulfide former; furthermore, it has the uncommon ability to alter the oxides and sulfides. Treatment with calcium modifies the melting point of inclu-

sions which rapidly float out of the steel, and also alters the morphology of any remaining inclusions, rendering them spherical in shape, very small, and finely dispersed. The result is a fundamental quality improvement, especially in the mechanical properties: formability, drawing, impact, tensile, machinability, resistance to cracking and tearing, and improved surface and internal cleanliness. Calcium also improves resistance to hydrogen induced cracking in line pipe associated with high-sulfur oil and gas pipelines.

In the maintenance free automotive battery, calcium improves electrical performance and battery life. The antimony-lead used in the conventional lead-acid battery is replaced with a 0.1% Ca-Pb grid alloy. The calcium improves the conductivity and current capability of the cell; it significantly reduces gassing, permitting the cell to be closed (preventing water loss and extending life).

High-energy density magnetic materials are produced using calcium. Samarium cobalt magnets with energy products of between 8 and 16 × 10<sup>4</sup> T·A/m have found applications in miniature transducers and other devices requiring high energy or volume restrictions. The reaction is:

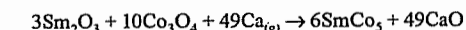

The development of neodymium ferro boron magnets involve the use of calcium metal as a reductant. This is an important development because these magnets have energy products approaching 40 × 10<sup>4</sup> T·A/m, over twice the value as for samarium cobalt. In addition, the availability of the raw materials is significantly greater than for samarium cobalt; both the quantity and stability of raw material supply limited the growth of samarium cobalt magnets. Therefore, neodymium ferro boron magnet materials are less expensive to produce.

The energy density is sufficient to permit the replacement of armature windings in motors, transducers, and generators with permanent magnets. The mass of an automotive starting motor was reduced from 3.6 kg to 1.8 kg; the size and cost of the motor were com-

mensurately reduced as well. This technology is finding extensive applications in automotive, computer peripheral, medical, home appliance, and military markets.

There are two methods of producing the neodymium ferro boron raw material, a neodymium iron alloy. One is the calcium thermal reduction method:

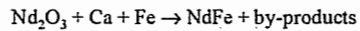
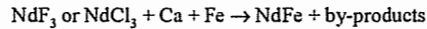

The second method is by electrolysis:

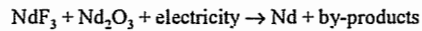
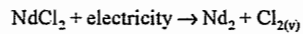

The calcium thermal reduction process is preferred. It has the greatest flexibility in producing the basic neodymium iron and alloy variations. The by-products are not toxic as they are in the electrolytic process. The calcium process is less capital intensive and readily scaled in volume to meet market demands.

In the *debismuthizing of lead* by the Kroll-Berterton process, calcium metal is combined with bismuth which then floats out in a dross:

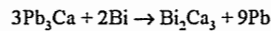

Lead ores are thus refined to commercial soft lead with 0.02% or less Bi.

Calcium metal is reacted with zirconium fluoride to refine *zirconium*; the high heat of reaction melts the zirconium. The zirconium ingot produced by this method is remelted under vacuum for purification. To produce *thorium* and *uranium*, the oxides are mixed with a stoichiometric excess of calcium and reduced under an atmosphere of argon. The resulting metals are leached with acetic acid to remove the lime produced as a by-product of the reaction.

Calcium metal is readily hydrided for use as a portable source of *hydrogen gas*. It also is used in the production of the B-complex vitamin calcium pantothenate.

*Calcium ferroalloys* are used in the production of nodular iron castings. In magnesium ferrosilicon, calcium reduces the reactivity, enhances nucleation, and improves morphology. The ratio of calcium to magnesium varies

from 0.15 to 0.50. Pieces of the ferroalloy are placed in a protected pocket cut in the refractory lining of the ladle prior to tap. The molten iron is then poured into the ladle where it reacts with the alloy. The treated, nodularized iron is then cast into molds.

In the recent in-mold process, granularized ferroalloy is placed in a special reaction chamber formed in the channels of the mold. This permits the reaction to occur when the iron is cast; it enhances the effectivity of the ferroalloy and results in improved castings. The process can be automated for high productivity.

Alloys of calcium also are used to deoxidize magnesium, to strengthen lead electrodes, and to produce special aluminum alloys.

Calcium is used to improve the mechanical properties of lead. A proprietary process for improving the integrity and formability of the lead used in yacht keels was developed in Australia and contributed to the nation's success in winning the America's Cup in 1984.

## 56.5 Lime and Limestone

### 56.5.1 Introduction

Limestone is a naturally occurring mineral that consists principally of calcium carbonate but may also contain magnesium carbonate as a secondary component. It is found in many forms and is classified in terms of its origin, chemical composition, structure, and geological formation. Limestone occurs widely throughout the world and is an essential raw material for many industries.

Quicklime is produced by the thermal decomposition of limestone. It consists mainly of calcium oxide. Its quality depends on many factors, including physical properties, degree of sintering, and chemical composition. As the most readily available and cost effective alkali, quicklime plays an essential part in a wide variety of industrial processes.

Hydrated lime and slaked lime are produced by reacting quicklime with water; they consist mainly of calcium hydroxide. In gen-

eral, hydrated lime refers to a dry calcium hydroxide powder, while slaked lime refers to an aqueous suspension of calcium hydroxide particles in water. Hydrated and slaked lime are widely used in aqueous systems as low-cost alkalis.

The term lime refers to quicklime and, less frequently, to hydrated or slaked lime. It is, however, sometimes used incorrectly to describe limestone, which is a frequent cause of confusion.

**History.** Limestone was probably used in the Stone Age. The first records relate to the Egyptian Second Dynasty (ca. 2800 B.C.), when it was employed in the construction of the Giza Pyramids. Marble, a highly crystalline form of limestone, was used by the Greeks shortly after this period for statues and the decoration of buildings. Limestone was widely used by the Romans for building roads.

There is evidence of the widespread use of quicklime and hydrated lime for building by many civilisations by about 1000 B.C., including the Greeks, Egyptians, Romans, Incas, Mayas, Chinese, and Mogul Indians. The Romans employed hydraulic lime in many construction projects, including the Appian Way.

Lime was also well known to the Romans as a chemical reagent. In 350 B.C. XENOPHON referred to the use of lime for bleaching linen. The medical use of limewater was recorded by DIOSCORIDES in 75 A.D.

The burning of limestone in kilns was mentioned by CATO in 184 B.C. PLINY THE ELDER (ca. 70 A.D.), in his "Chapters on Chemical Subjects" described the production, slaking, and uses of lime, and stressed the importance of chemical purity.

The use of limestone and lime in building spread throughout Europe in the 1400s.

In the 1700s, JOSEPH BLACK gave the first sound technical explanation of the calcination of limestone, including the evolution of gaseous carbon dioxide. LAVOISIER confirmed and developed BLACK's explanation. In 1766, DE RAMECOURT, published a detailed account of "The Art of the Lime Burner" which covered

the design, operation, and economic aspects of limestone quarrying and lime burning.

**Terminology.** Because the quarrying of limestone and the production of quicklime and hydrated lime are long-established industries, they have generated many traditional expressions which frequently cause confusion. The following definitions cover the most common terms. A more comprehensive list has been published [6].

*Air-slaked lime* is produced by excessive exposure of quicklime to the atmosphere. It contains varying proportions of the oxides, hydroxides, and carbonates of calcium and magnesium.

*Agricultural lime* is a term which includes any limestone, quicklime, or hydrated lime product used to neutralize soil acidity.

*Aragonite* is one of the less abundant crystalline forms of calcium carbonate.

*Available lime* is an analytical term for the calcium oxide content of quicklime or hydrated lime that is able to react with sucrose under specified conditions.

*Bituminous limestone* — see carboniferous limestone.

*Carbonaceous limestone* contains organic matter as an impurity. It is often dark gray and has a musty odor.

*Carboniferous limestone* was deposited in the carboniferous period of the Palaeozoic era.

*Calcitic limestone* refers to a high-calcium limestone.

*Calcite* is the most abundant crystalline form of calcium carbonate.

*Cement* is produced by calcining limestone with materials containing silica, alumina, and iron oxide to produce a controlled blend of calcium silicates, aluminates, and ferrates in the form of a clinker. The clinker is then ground with gypsum and other materials to form cement.

*Chalk* is a naturally occurring form of limestone, which has been only partially compacted and, therefore, has a high porosity.

*Chemical quality limestone* is a high-calcium or dolomitic limestone with low levels of

impurities, which meets the requirements of the chemical industry.

*Dead-burned dolomite* is a highly sintered form of dolomitic quicklime which is used primarily as a basic refractory.

*Dolime* refers to calcined dolomite.

*Dolomite* is strictly speaking the double carbonate containing 54–58% of  $\text{CaCO}_3$  and 40–44% of  $\text{MgCO}_3$ . This term is, however, frequently used to describe dolomitic limestone.

*Dolomitic limestone* is generally understood to contain 20–44% of  $\text{MgCO}_3$ .

*Fine quicklime* generally refers to screened products with a top size below 0.6 cm.

*Free lime* is an analytical term for the calcium oxide component of quicklime or hydrated lime. It excludes calcium oxide in  $\text{CaCO}_3$ ,  $\text{Ca}(\text{OH})_2$ , and calcium silicates.

*Granular quicklime* usually refers to screened products with a top size of 0.5–2.5 cm.

*Ground quicklime* refers to powdered products produced by milling.

*Hard-burned quicklime* is a sintered form of quicklime with low reactivity to water.

*High-calcium limestone* is a general term for limestone consisting mainly of  $\text{CaCO}_3$  and having a low content of  $\text{MgCO}_3$  (max. 5%). Similarly, high-calcium quicklime contains mainly  $\text{CaO}$  and not more than 5%  $\text{MgO}$ .

*Hydrated lime* is a dry powder produced by reacting quicklime with controlled amounts of water.

*Hydraulic limestone* is an impure carbonate containing considerable amounts of silica and alumina. Calcination of hydraulic limestone produces hydraulic lime, which, after mixing with water, has cementing (or hydraulic) properties and is capable of setting under water.

*Iceland spar* is a rare and very pure form of crystalline limestone. It is transparent and has been used in optical instruments.

*Light-burned quicklime* is quicklime that is lightly sintered and has a high reactivity to water.

*Lime putty* is a viscous dispersion of calcium hydroxide in water.

*Lump quicklime* usually refers to products with a top size above 2 cm.

*Magnesian limestone* is generally understood to be mainly  $\text{CaCO}_3$  with 5–20% of  $\text{MgCO}_3$ .

*Marble* is a highly crystalline carbonate rock which may be high-calcium or dolomitic limestone. It occurs in many colors with veined and mottled effects.

*Marl* is an impure, soft, earthy rock which contains clay and sand. If it contains more than 50%  $\text{CaCO}_3$ , it is classified as a limestone.

*Milk of lime* is a fluid suspension of hydrated lime in water.

*Neutralizing value* is an analytical term for that proportion of limestone, quicklime, or hydrated lime (expressed as  $\text{CaO}$ ) that is capable of reacting with hydrochloric acid under specified conditions. It includes the contribution of  $\text{CaCO}_3$ ,  $\text{CaO}$ ,  $\text{Ca}(\text{OH})_2$ , and the acid soluble fraction of the calcium silicates, aluminates, and ferrates.

*Pebble quicklime* usually refers to screened products with a top size of 1.5–6 cm.

*Precipitated calcium carbonate (PCC)* is produced by blowing carbon dioxide into milk of lime, thereby precipitating finely divided calcium carbonate with a mean particle size in the range 0.02 to 0.2  $\mu\text{m}$ .

*Reactivity* of quicklime is a measure of the rate at which it reacts with water. There are many reactivity tests (see Section 56.5.3.1).

*Slaked lime* generally describes an aqueous suspension of mainly calcium hydroxide. It includes milk of lime and lime putties. The term slaked lime is sometimes used to describe hydrated lime.

*Soft-burned quicklime* — see light-burned quicklime.

*Solid-burned quicklime* — see hard-burned quicklime.

*Total lime* is an analytical term for the total  $\text{CaO}$  plus  $\text{MgO}$  content of a limestone or lime, expressed in terms of  $\text{CaO}$  equivalent. It includes the carbonates, oxides, hydroxides, silicates, aluminates, and ferrates.

*Type N* or normal hydrated lime is defined in ASTM specification C-207 [7]. It is gener-

ally produced by hydrating high-calcium quicklime at ca. 100 °C.

*Type S* hydrated lime is also defined in ASTM specification C-207 [7]. It is produced by heating high-calcium or magnesian lime in an autoclave at ca. 180 °C. It may contain up to 8% of unhydrated oxide.

*Whiting* is a finely powdered product produced by milling and classifying limestone (generally chalk). The nominal top size varies from 75 to 10  $\mu\text{m}$ .

## 56.5.2 Limestone

### 56.5.2.1 Physical and Chemical Properties

The physical and chemical properties of limestones vary widely as a result of the origin of the deposit, its microstructure, and impurities. The information given below is typical of most commercially exploited deposits.

**Color.** Pure calcite is white. Chalk and marble are also generally white, although impurities in the latter can produce a variety of colors and patterns. Many limestones, however, contain carbonaceous material, which produces various shades of gray. Iron compounds can introduce a red color. Some impurities produce a surface coloration on weathering.

**Odor.** Any odor possessed by limestone generally arises from its content of carbonaceous material. The smell is musty or earthy.

**Structure.** All limestones are crystalline. The grain size increases with the amount of recrystallization that has occurred during formation of the deposit. Thus, shell limestones have a grain size of ca. 1  $\mu\text{m}$ , marls and chalks from 2 to 5  $\mu\text{m}$ , dense limestones from 5 to 250  $\mu\text{m}$ , and marbles and calcite spar from 250 to 1000  $\mu\text{m}$ . Calcite and dolomite have rhombohedral crystal structures, and aragonite is orthorhombic.

**Porosity.** The porosity of limestone decreases with increasing levels of compaction. Thus, marls have up to 50% porosity, chalks 20–

40%, dense limestones 1–10%, and calcite spar < 1%.

**Density.** For pure calcite, the density is 2.71  $\text{g/cm}^3$  at 20 °C; for aragonite and dolomite, it is 2.93  $\text{g/cm}^3$  and ca. 3.0  $\text{g/cm}^3$ , respectively. The porosity of limestone results in apparent densities of 2.1–2.5  $\text{g/cm}^3$  for chalk, 2.5–2.7  $\text{g/cm}^3$  for high-calcium limestone, and 2.75–2.9  $\text{g/cm}^3$  for dolomitic limestones.

**Bulk Density.** The bulk density depends primarily on the apparent density of the limestone and its particle size distribution. Crushed, screened limestone with a 2:1 size ratio generally has a bulk density of 1300–1450  $\text{kg/m}^3$ . Crushed limestone, including the fines, has a bulk density of 1600–1750  $\text{kg/m}^3$ .

**Impurities.** Magnesium carbonate is not generally regarded as an impurity. Impurities may be dispersed homogeneously as a result of their being present during the recrystallization process. Alternatively they may be present heterogeneously in features such as faults, bedding planes, or nodules. Silica and alumina, in the form of clay, silt, and sand, are commonly found as homogeneous impurities, but also occur as heterogeneous impurities. Similarly, iron can exist homogeneously as iron carbonate and heterogeneously as pyrite and limonite. Sulfur from sulfates and organic remains generally exists as a homogeneous impurity. Other trace impurities such as lead are often found in the vicinity of faults where mineralization has occurred. Typical levels of trace elements are given in Table 56.4.

**Hardness.** Pure calcite has a hardness of 3 Mohs. Naturally occurring limestones lie in the range 2–4 Mohs.

**Strength.** The compressive strength of limestone varies from 10 MPa for some marls and chalks to 200 MPa for some marbles.

**Specific Heat.** The specific heats of high-calcium limestone and dolomite at 20 °C are 817 and 880  $\text{J kg}^{-1}\text{K}^{-1}$ , respectively. They increase with temperature [8].

**Solubility.** The solubility of calcite in distilled water free of carbon dioxide has been reported

as ca. 15 mg/L at 20 °C [6]. The solubility in distilled water in equilibrium with atmospheric carbon dioxide is approximately double the above value. Dolomite has been reported as being somewhat more soluble than calcite [6].

**Reaction with Acids.** Calcium carbonate reacts with acids with evolution of carbon dioxide and heat (reported to be about 19 kJ/mol in hydrochloric acid [9]).

**pH.** Both limestone and dolomite are essentially neutral products, giving pHs of 8.5–9.0.

**Thermal Dissociation.** The heat of dissociation of calcium carbonate is 3180 kJ/kg of CaO relative to 25 °C, and 3010 kJ/kg relative to 900 °C (760 kcal/kg and 720 kcal/kg, respectively). The corresponding values for magnesium carbonate are 3010 kJ/kg MgO relative to 25 °C, and 2850 kJ/kg relative to 700 °C.

**Table 56.4:** Typical trace element concentrations in limestone.

| Element | Concentration | Element | Concentration  |
|---------|---------------|---------|----------------|
| Al      | 0.05–0.6%     | Ni      | 1–5 mg/kg      |
| Ba      | 0.02–0.2%     | P       | 0.02–0.2%      |
| B       | 1–50 mg/kg    | K       | 0.01–0.5%      |
| C       | 0.05–1%       | Ag      | 0.2qP0.5 mg/kg |
| Cd      | 0.1–2 mg/kg   | Na      | 0.01–0.2%      |
| Cr      | 10–500 mg/kg  | Si      | 0.2–5%         |
| Cu      | 0.5–10 mg/kg  | Sr      | 20–2000 mg/kg  |
| Co      | 0.5–5 mg/kg   | S       | 0.01–0.2%      |
| Fe      | 0.01–0.1%     | Sn      | ca. 20 mg/kg   |
| Pb      | 1–100 mg/kg   | Ti      | 0.01–1%        |
| Mn      | 20–300 mg/kg  | V       | 5–50 mg/kg     |
| Hg      | < 1 mg/kg     | Zn      | 1–200 mg/kg    |
| Mo      | ca. 20 mg/kg  |         |                |

### 56.5.2.2 Formation and Occurrence

Limestone is widely distributed throughout the world in deposits of varying sizes and degrees of purity. Information regarding the deposits in a given country is generally best obtained by contacting the appropriate national geological society.

The process of limestone formation is believed to have started with the extraction of calcium salts from the earliest forms of igneous rocks by the combined effects of erosion

by the weather and corrosion by dissolved acids, e.g., sulfurous acid and carbon dioxide.

Under certain conditions of concentration and temperature, calcium carbonate precipitated from the solutions of calcium salts. Deposits with such chemical origins are generally thin, of limited extent, and therefore of little commercial importance.

When the solutions of calcium salts drained into the sea, marine life extracted the dissolved calcium hydrogen carbonate component to build shells and skeletons of calcium carbonate. These gradually accumulated on the bed of shallow tropical seas to produce deposits, many of which were massive. The calcium carbonate became contaminated by waterborne clays and silts, and by airborne volcanic ash. The extent of contamination depended on the distance from estuaries and volcanoes. In general the purest deposits originated from mid-ocean banks remote from land.

The limestone deposits became covered with other materials and were subjected to solvent action under high pressure and temperature. This consolidated the deposits and caused recrystallization to varying degrees. The sequence marl, chalk, limestone, and marble shows progressive consolidation and change of structure. Soft marls are porous and contain well-defined fossils. Marble is particularly dense, highly crystalline, and contains no discernible fossils. The grain size ranges from less than 5 µm for marls and chalks to over 250 µm for some marbles and calcite. Such rocks in which the original marine deposits have recrystallized are termed sedimentary clastic rocks, while the process of structural change is known as metamorphosis.

### 56.5.2.3 Production

Most limestone is produced by open-cast quarrying. A small proportion (less than 5%) is extracted by underground mining and a still smaller proportion (less than 1%) as cut dimension-stone.

The first operation in open-cast quarrying is to remove the overburden (i.e., the soil, clay,

and loose rock overlying the deposit). Various techniques and types of earth moving equipment are used for this.

The next stage is generally to drill the bedrock. Rotary and percussive drills are widely used to drill the holes. The spacing between holes and the burden (distance between the holes and the quarry face) is carefully controlled. The diameter of the holes varies from 5–25 cm, depending on the design of the blast.

The drill holes are then filled with controlled amounts of explosive. A mixture of ammonium nitrate and fuel oil (ANFO) is widely used; it is initiated with a high explosive. In a typical blast, 5000–50 000 t of stone is fragmented with about 140 g of explosive per 1 t limestone.

It is important to control the blast. Too little fragmentation produces oversize boulders which have to be broken using secondary blasting or a drop ball. Too much fragmentation produces an excessive amount of fine particles and increases the risk of throwing rock away from the quarry face. Optimum fragmentation is obtained by selection of the correct diameter and spacing of holes, time delay between holes, thickness of burden, and quantity of explosive.

Some soft rocks, e.g., chalk and marl, are broken by using heavy rippers. Other soft deposits, as found in lakes or in the sea, are extracted with dredgers. Underground mining is used when the overburden is thick, or when the limestone deposit is overlain by other rocks. Most operations use the room and pillar technique.

After blasting, the rock is loaded into dump trucks, generally by front-end shovels or hydraulic excavators and transported to the crushing and screening plant. In the crushing and screening plant, the larger lumps of rock are broken in a primary crusher to a size which suits the needs of the business and the characteristics of subsequent equipment. The rock is then screened into oversize (e.g., +15 cm), large (e.g., –15 +5 cm), medium (e.g., –5 +0.6 cm), and fine (e.g., –0.6 cm) fractions. The oversize stone is frequently recrushed and rescreened. The fine fraction is rich in impurities

such as clay, and is often tipped. In some plants clay and the fine fractions are removed more efficiently by washing and screening.

Compression machines such as jaw, gyratory, and roll crushers are generally selected when the amount of fine fraction must be minimized and when slabby lumps can be tolerated. Impact crushers such as hammer mills and impact breakers are selected when cubical lumps are required and increased fines production can be tolerated. Impact crushers have the advantage of being able to achieve a greater size reduction at lower capital cost. Although the major demand for limestone is in the –2.5 +0.1 cm size range, specialized requirements exist for very finely divided products, which are produced in a variety of mills, generally by dry grinding.

Dimension-stone production (for facing buildings and ornamental use) is a specialized process in which blocks are cut from the rock face with channelling machines or wire saws. The blocks are then cut, shaped, and, if required, polished to make the finished product.

### 56.5.2.4 Uses and Specifications

**Construction.** Limestone is the most widely used crushed rock, although it is generally out-sold by sand and gravel.

The quality specifications for construction stone relate mainly to its physical properties. Thus the stone must be clean, strong, dense, durable, free from cracks, and have the required particle size distribution. Some specifications limit the amounts of organic matter, clay, or water-soluble components (e.g., alkali-metal salts and gypsum). Specifications for the stone in the top dressing of roads (particularly in the vicinity of junctions) sometimes require a high resistance to polishing; this excludes the use of limestone. Standards for the testing and size distribution of roadstone and construction stone are given later.

**Cement.** The production of cement is the main use for chalk, and a major use for dense, high-calcium limestone. Approximately 1.1 t of limestone is required for 1 t cement. For the

estimated worldwide production of cement in 1987 of  $1050 \times 10^6$  t [10], the consumption of limestone was ca.  $1150 \times 10^6$  t.

Because cement is a mixture of calcium silicates, aluminate, and ferrate, the presence of  $\text{SiO}_2$ ,  $\text{Al}_2\text{O}_3$ , and  $\text{Fe}_2\text{O}_3$  in the feedstone is acceptable, provided the level is uniform. When the composition of the limestone is variable, elaborate arrangements are made to produce a consistent chemical analysis by blending. The magnesium carbonate content, however, must be below 5%.

**Quicklime.** Approximately 1.8 t of limestone is required per 1.0 t of quicklime. Further details are given later.

**Agriculture.** Many crops grow best under neutral to slightly acid conditions (i.e., pH 6–7). Thus soils which are more acidic than pH 6 generally benefit from the application of limestone. The limestone also helps to replace the calcium and magnesium removed by crops. Other benefits include an increase in the supply of other chemical nutrients, an increase in the organic matter of the soil, an increase in beneficial soil microorganisms, improved soil tilth, an improved supply of trace elements, and an increase in the efficiency with which fertilizers are used by the crop [6].

It is important that the limestone used for agriculture is in the correct physical state; a top size of ca. 0.1 cm is generally required. The delivered cost per tonne of carbonate is an important factor. In some cases, the magnesium content of dolomite gives it an advantage over high calcium limestone.

Limestone is also used in animal feeds and poultry grit. In animal feeds, trace elements may be restricted (e.g., lead levels below 10 mg/kg).

**Metal Refining.** When limestone is used in metal refining it is initially converted to quicklime, which reacts with acidic oxides (e.g.,  $\text{SiO}_2$ ,  $\text{Al}_2\text{O}_3$ , and  $\text{Fe}_2\text{O}_3$ ) to produce molten slags. Most is used in blast furnaces for the production of iron, where the slag typically contains 40–50% CaO. Smaller amounts are used in the production of copper, lead, zinc,

and antimony. The quality requirements are as for chemical-quality stone. Some magnesium carbonate is acceptable but not essential.

**Flue Gas Desulfurization.** A growing use of limestone is in the treatment of flue gas to remove sulfur dioxide. The limestone is finely ground to 90% less than  $45 \mu\text{m}$  and reacted with flue gases in a scrubber. The resulting calcium sulfate may be converted to salable gypsum, in which case the  $\text{MgCO}_3$  content should not exceed 1%.

**Other Uses.** There are many other uses of limestone, e.g., production of alumina, glass, wood pulp, paper, ceramics, mineral wool, fillers, whiting, and coal-mine dusts, neutralization of acids and construction of filter beds; they are described in [6].

### 56.5.3 Quicklime

#### 56.5.3.1 Physical and Chemical Properties.

**Color.** Most quicklimes are white. Impurities can result in gray, brown, or yellow tints. When quicklime is produced by solid fuel firing, a gray surface contamination is produced.

**Odor.** Quicklime has a slight earthy odor.

**Porosity.** The porosity of commercially produced quicklime can be as high as 55%, if a highly porous limestone is lightly burned. Exposure to elevated temperature results in sintering (Figure 56.1) which can reduce the porosity to below 25%. Dead-burned dolomite has a porosity of ca. 10%.

**Density.** The true density of calcium oxide is ca.  $3.3 \text{ g/cm}^3$ . The apparent density of lumps can be as low as  $1.4 \text{ g/cm}^3$  for highly porous quicklime. This can rise to over  $2.3 \text{ g/cm}^3$  after sintering (Figure 56.2).

Calcined dolomite is generally denser than high-calcium quicklime, if given the same heat treatment. Dead-burned dolomite has an apparent density of ca.  $3.2 \text{ g/cm}^3$ .

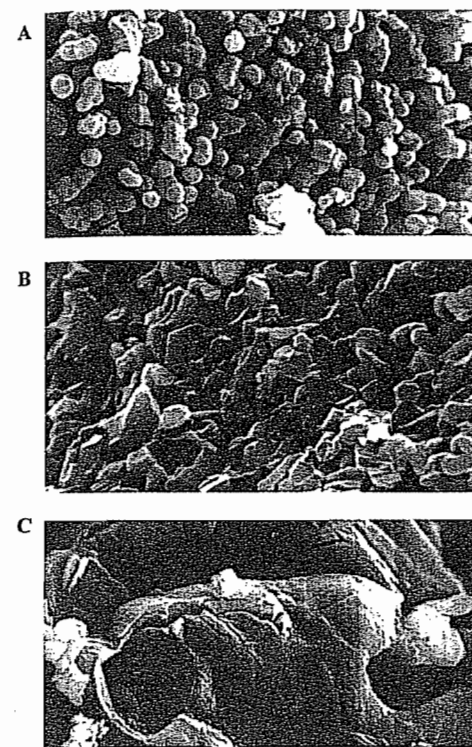

Figure 56.1: Scanning electron micrographs of quicklimes. A) Apparent density  $1.5 \text{ g/cm}^3$ ; B) Apparent density  $1.9 \text{ g/cm}^3$ ; C) Apparent density  $2.3 \text{ g/cm}^3$ .

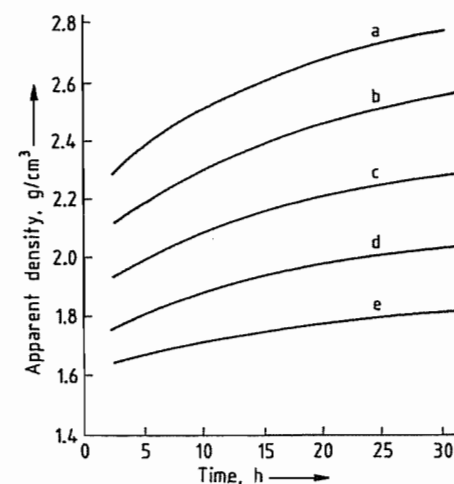

Figure 56.2: Variation of apparent density with temperature and time for a dense, high-calcium quicklime: a) At  $1400 \text{ }^\circ\text{C}$ ; b)  $1300 \text{ }^\circ\text{C}$ ; c)  $1200 \text{ }^\circ\text{C}$ ; d)  $1100 \text{ }^\circ\text{C}$ ; e)  $1000 \text{ }^\circ\text{C}$ .

**Bulk Density.** The bulk density depends on the mean apparent density of the particles and on the voidage between them. The latter is related to the particle size distribution and the particle shape. Most screened commercial quicklime products have compacted bulk densities of  $900\text{--}1200 \text{ kg/m}^3$ . Inclusion of fines can increase the bulk density by 30%.

**Hardness.** Most commercial quicklime products have a hardness of 2–3 Mohs. The value for dead-burned dolomite is in the range 3 to 5 Mohs.

**Melting Point.** The melting points for calcium oxide and magnesium oxide are  $2570 \text{ }^\circ\text{C}$  and  $2800 \text{ }^\circ\text{C}$ , respectively, with calcined dolomite being intermediate [11].

**Specific Heat.** The mean specific heats for high-calcium and dolomitic quicklime at  $20 \text{ }^\circ\text{C}$  are  $760$  and  $830 \text{ Jkg}^{-1}\text{K}^{-1}$ , respectively. They increase with temperature [8].

**Angle of Repose.** The angle of repose for cubical, well-graded pebble quicklime is about  $35^\circ$ . This increases, however, as the fines content increases. For bunker design, valley angles of not less than  $60^\circ$  are recommended.

**Heat of Hydration.** The heat liberated by the reaction of quicklime with water is  $1140 \text{ kJ/kg}$  of CaO. The value for dolime is  $880 \text{ kJ/kg}$  of  $\text{CaO}\cdot\text{MgO}$ .

**Reactivity** to water may be measured by the rate of release of the heat of hydration [12, 13, 14] or by the rate at which an aqueous suspension reacts with hydrochloric acid [15]. The relationships between some reactivity tests are shown in Figure 56.3. Reactivity is related to the mean apparent density of quicklime produced from a given source stone (Figure 56.4).

It should be noted that the reactivity of quicklime can be markedly affected by impurities in the water. For this reason, distilled water should be used as a reference standard.

The low reactivity of calcined dolomite probably arises mainly from the low solubility of  $\text{Mg}(\text{OH})_2$  in water. Sintering of  $\text{MgO}$ , which forms at lower temperatures than CaO may also be a factor.

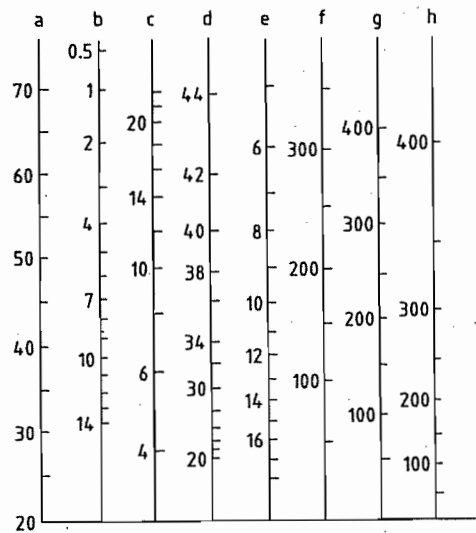

**Figure 56.3:** Comparisons between reactivity tests for a high-calcium quicklime: a) BS 6463, temperature after 2 min, °C [12]; b) DIN 1060, time (min) to 60 °C [13]; c) ASTM 110, temperature rise after 30 s, °C [14]; d) ASTM C 110, maximum temperature rise, °C [14]; e) ASTM C 110, time (min) to maximum temperature [14]; f) Acid titration, mL at 3 min [15]; g) Acid titration, mL at 5 min [15]; h) Acid titration, mL at 10 min [15].

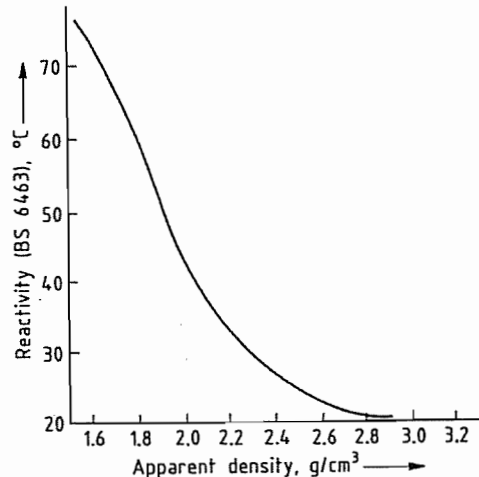

**Figure 56.4:** Relationship between reactivity and apparent density for a high-calcium quicklime.

**Affinity for Water.** Quicklime has a high affinity for water and is a more efficient desiccant than silica gel. Because of its high affinity for water vapor and (after partial hydration) for carbon dioxide, care should be taken to

minimize exposure of quicklime to the atmosphere. Relatively small amounts of air slaking (less than 1.5%, of combined water) can reduce the reactivity significantly.

The reaction of quicklime with water is associated with an increase in volume. This can cause the expansion of products that contain some lime which is not fully hydrated.

**Reaction with Carbon Dioxide.** In the absence of calcium hydroxide, quicklime only reacts with dry carbon dioxide above ca. 300 °C and below ca. 800 °C, depending on the carbon dioxide pressure. Partial recarbonation in the absence of calcium hydroxide can occur in lime kilns under certain abnormal conditions. It can produce an unexpectedly low reactivity and markedly affects the normal relationship between reactivity and mean apparent specific gravity.

**Acid Neutralization.** Quicklime is used extensively to neutralize acidic oxides, such as  $\text{SiO}_2$ ,  $\text{Al}_2\text{O}_3$ , and  $\text{Fe}_2\text{O}_3$ , in high-temperature nonaqueous systems (e.g., in steel making). Temperatures are generally selected so that the resulting calcium and magnesium salts produce molten slags.

**Reaction with Carbon.** Above 1700 °C, carbon reduces calcium oxide to produce calcium carbide and carbon monoxide.

### 56.5.3.2 Raw Materials

#### Limestone

**Size.** The ratio of the top to bottom sizes in the stone fed to lime kilns should preferably be 2:1 and certainly no more than 3:1. This gives an open, porous bed which offers a low resistance to gas flow and heat transfer. The narrow size range also helps to limit sintering of the smaller sizes while the larger are still dissociating. Selection of the size is influenced by the cost and availability of the stone and by the limitations imposed by the design of the lime kiln.

**Shape.** While a cubical shape is generally preferred for lime kilns, the slabby shapes pro-

duced by jaw and roll crushers are acceptable, providing they do not lead to a packed bed with low porosity.

**Strength and Abrasion Resistance.** Both the stone and the quicklime should be sufficiently strong to resist the physical forces to which they are exposed in the kiln and the handling and storage system. Excessive breakage in the kiln increases the resistance to gas flow and heat transfer. Breakage reduces the yield of granular products, which are usually at a premium, and increases the yield of fines, which are usually in surplus. Various empirical tests have been developed by kiln manufacturers to quantify the above factors.

**Thermal Degradation.** Some limestones, and particularly highly crystalline ones, are prone to break-down as a result of the heating, calcining, or thermal cycling processes within the kiln. Various empirical tests have been developed to quantify these effects.

**Water.** Some chalks are highly porous and may contain 10% water, which reduces the temperature of the kiln exhaust gas and may cause condensation problems in dust collectors.

**Impurities.** When limestone is burned in a kiln, most of the impurities persist in the quicklime. Permissible levels of  $\text{SiO}_2$ ,  $\text{MgO}$ ,  $\text{Al}_2\text{O}_3$ ,  $\text{Fe}_2\text{O}_3$ , S, Pb, and F depend on the quality specifications for the quicklime. Heterogeneous impurities (e.g., those arising from contamination with clay) tend to concentrate in the smaller sizes of quicklime. Removal of the fines (e.g., -6 mm) by screening generally improves product quality. Much of the sodium and potassium compounds and some of the sulfur compounds are removed during calcination. Sulfur oxides, most of which may arise from the fuel, are reabsorbed onto the surface of the quicklime at the start of the calcining zone and concentrate in the fine fraction.

#### Fuel

In lime burning, the fuel is more than a source of heat. It interacts with the process,

and the combustion products react with the quicklime. Many different fuels are used in lime kilns. The most common is coal. Coke, fuel oil, and natural gas are also widely used.

Selection of the correct fuel is important to the lime producer. Its cost per tonne of quicklime frequently represents 50% of the total production cost. Some fuels cannot be used in certain kilns. Other fuels may markedly affect the heat usage, output, and product quality. Some require different refractory linings to be used.

The selection of a new fuel, e.g., a different coal, is often a matter of trial and error. The selection for a new kiln should be made with great care. Most kilns can be operated on more than one fuel, and enable the operator to select the ones which give the optimum economic performance for his situation.

The major factors relating to the performance and acceptability of fuel are discussed briefly below. Further details are available in [6].

**Calorific Value.** The calorific value coupled with the unit cost of the fuel and the kiln heat usage enables the cost of the fuel per unit of quicklime to be calculated. Some confusion arises between the gross (or upper) and the net (or lower) calorific values. The former includes the latent heat of condensation of the water produced by combustion; it is used in North America and the United Kingdom. The net value more logically excludes the latent heat; it is widely used in, for example, continental Europe and Japan.

**Sulfur.** Some of the most important markets for quicklime, notably steelmaking, require low sulfur levels. Sulfur from the fuel is absorbed by quicklime in the cooler part of the calcining zone of lime kilns as calcium sulfate. In the more efficient kilns, e.g., shaft kilns, most of this sulfur is retained in the quicklime. In the less efficient units, e.g., some rotary kilns, much of the sulfur from the fuel may be eliminated from the kiln in the kiln gases by operating the calcining zone with low levels of excess air and high temperatures, and by limit-



ing contact between the kiln gases and the quicklime in the cooler part of that zone.

**Combustion Characteristics.** The combustion characteristics of fuels vary markedly. Pulverized coal tends to burn with a short, hot, and highly (infrared) emissive flame. Natural gas and wood burn with longer, cooler flames which have lower emissivities. These differences can affect many aspects of quality, and particularly the relationship between the residual  $\text{CaCO}_3$  content and the reactivity to water.

**Particle Size.** Solid fuels should be of the correct particle size. In some cases they need to have adequate strength. Their coking properties may be critical, as may be the amount of volatile matter. The ash generally contaminates the lime to some degree with silica, iron oxide, and alumina. It may cause bridging between particles, and can also combine with lime dust and with volatile alkalis (sodium and potassium) to form troublesome deposits.

**Ash Fusion.** The properties of the fuel ash can have a marked effect on the acceptability of the fuel. Key properties include the ash content of the fuel, the ash fusion temperature (which is affected by lime dust and by the concentration of oxygen and carbon monoxide in the atmosphere), and the level of alkalis.

### 56.5.3.3 Production

#### Calcination

The chemical reaction for the decomposition of calcium carbonate by heat is:

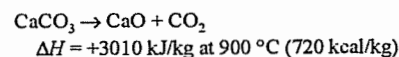

Figure 56.5 shows the variation of the partial pressure of carbon dioxide above calcium carbonate with temperature. The pressure is 101 kPa at ca. 900 °C. Thus, although surface calcination can proceed at lower temperatures, complete calcination only occurs above 900 °C.

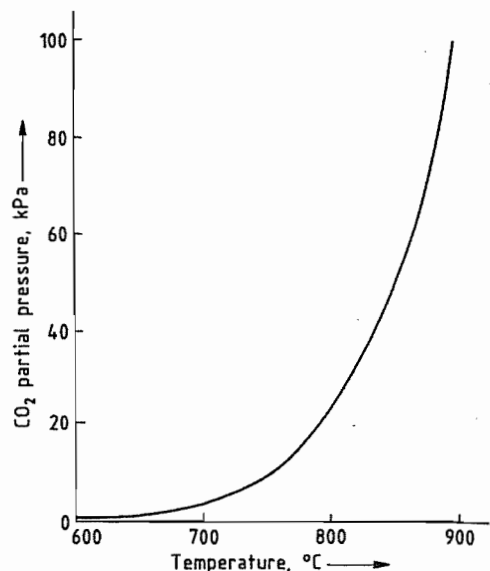

Figure 56.5: Variation of the  $\text{CO}_2$  partial pressure above  $\text{CaCO}_3$  with temperature.

The calcination mechanism is complex and involves several stages: heat transfer to the surface of the particle and through the outer layer of lime. The heat is absorbed by the chemical reaction at the lime-limestone interface. The carbon dioxide so generated migrates to the surface of the particle counter to the heat flow and then diffuses from the surface into the kiln gases.

The rate-determining stage in the above process depends on the particle size, temperature, amount of calcination that has already taken place, and the composition of the kiln gases. Although attempts have been made to produce a mathematical model to account for observed effects in practical lime burning, none has proved applicable over wide ranges of the above variables.

Figures 56.6 and 56.7 summarize smoothed results for calcining spheres of U.K. carboniferous limestone. Although the results do not apply accurately to the random shapes encountered in practice or to other limestones, they serve as a useful guide to the relative effect of changing residence time or temperature.

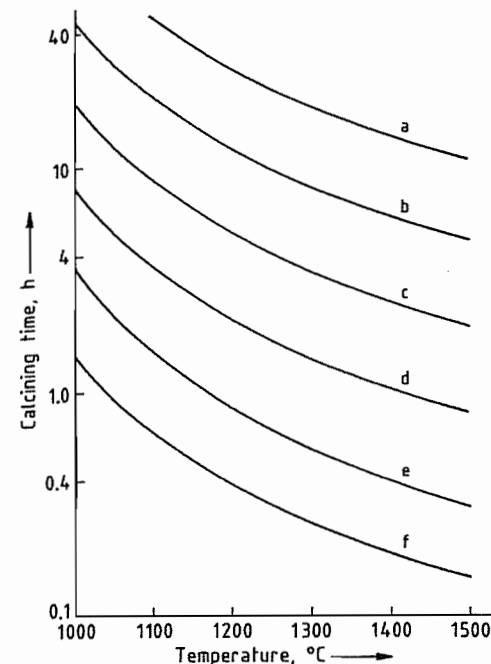

Figure 56.6: Calcining times for spheres of a dense, high-calcium limestone: a) 15 cm; b) 12.5 cm; c) 10 cm; d) 7.5 cm; e) 5 cm; f) 2.5 cm diameter.

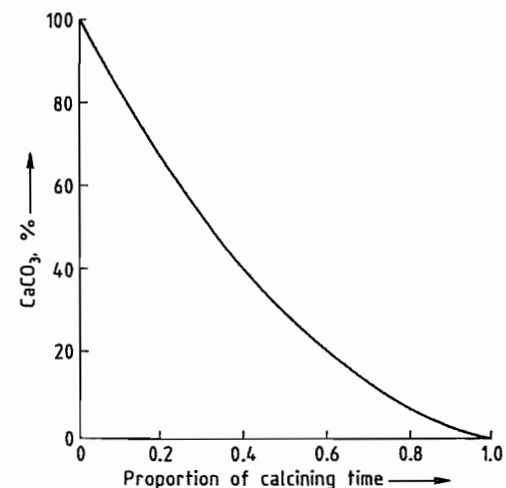

Figure 56.7: Progression of calcination of limestone spheres.

Figure 56.6 shows the marked variation in the time for complete calcination caused by changes in particle size. This is one of the reasons why the size range of stone fed to lime

kilns is generally in the ratio of 2:1. The other reasons are the effects on sintering and on the porosity of the stone bed, which must be sufficiently high to allow rapid gas flow and efficient heat transfer.

When a high-calcium limestone particle is decomposed at low temperature (950 °C or below), its external dimensions do not change significantly. Calcination of limestone with 2% porosity theoretically produces quicklime with a porosity of 54%, corresponding to an apparent density of 1.5 g/cm<sup>3</sup>.

Prolonged heating of quicklime above 900 °C causes sintering, a reduction in porosity, and an increase in apparent density (see Figure 56.2). This sintering process markedly reduces the reactivity of the quicklime to water (see Figure 56.4).

In lime kilns, variations in heat distribution, temperature, and solids residence time further complicate the calcination process. As a result the quicklime particles discharged from the kiln can be grouped into three categories:

- Particles that are not fully calcined (i.e., with a central  $\text{CaCO}_3$  core), the lime layer of which has a low apparent density and a high reactivity to water
- Particles that are just fully calcined and have a low apparent density and a high reactivity to water
- Particles that have sintered to varying degrees and which have an increased apparent density and a reduced reactivity to water

The relative quantities of product in the above categories are influenced by the kiln design. In most kilns, the quicklime is exposed to gas temperatures of 1200–1300 °C just before it enters the cooling zone. Generally, such kilns only produce highly reactive quicklime from high-calcium limestone if the residual  $\text{CaCO}_3$  content is relatively high. Some designs complete the calcination at a lower temperature (ca. 1100 °C), and produce a highly reactive quicklime with low levels of  $\text{CaCO}_3$ . In some kilns, changing the air fuel ratio can affect the characteristics of the quicklime. A low ratio lengthens the flame, and hence the calcining zone, and reduces maximum gas

temperatures. This leads to a higher reactivity for a given  $\text{CaCO}_3$  content. It may, however, increase unit heat usage.

If the quicklime is exposed to kiln gases containing carbon dioxide at 600–800 °C, re-carbonation occurs. This increases the  $\text{CaCO}_3$  level and reduces the active CaO content slightly. The most marked effect, however, is the reduction in the reactivity of the quicklime.

A small amount of re-carbonation always occurs in the cooling zone of the kiln as a result of air slaking. The quantities involved are, however, small and the effect on the quality of the quicklime is negligible.

Any magnesium carbonate in the limestone decomposes at ca. 700 °C. Its heat of calcination is lower than that of calcium carbonate. The resulting magnesium oxide does not contribute significantly to the reactivity towards water.

### Lime Kilns

Early lime kilns were constructed of stone and were generally built into the side of a hill [16]. An amount of fuel, originally wood, was placed on a hearth at the base of the kiln. Large stones were placed above the fuel, followed by layers of increasingly smaller stone. The fuel was then lit and allowed to burn for a few days. After the fire had burned out and the lime had cooled, the kiln was drawn-down by hand from the hearth. The product often contained substantial amounts of both over- and under-burned lumps, and the thermal efficiencies were very low.

It was then recognized that a continuously operating lime kiln would be more productive and more thermally efficient. For the purpose of heat transfer, a kiln should be regarded as consisting of three zones (Figure 56.8).

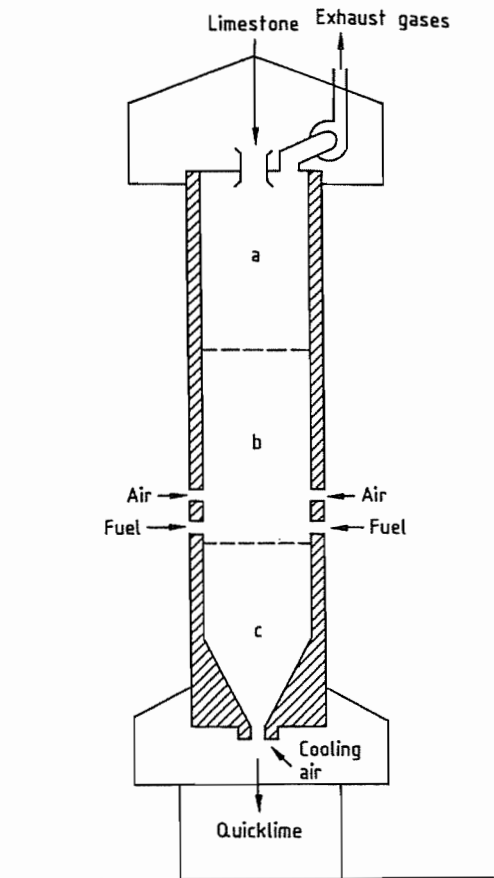

Figure 56.8: Schematic of a vertical shaft kiln: a) Preheating zone; b) Calcining zone; c) Cooling zone.

In the pre-heating zone, limestone is heated from ambient temperature to over 800 °C by the heat of the gases emerging from the calcining zone. In the calcining zone, the calcium carbonate is decomposed into calcium oxide, thereby absorbing some of the heat of combustion produced by burning the fuel and pre-heated air. In the cooling zone, quicklime is cooled by part or all of the combustion air, which in turn is preheated.

Subsequently, vertical shaft, mixed-feed kilns were developed in which layers of stone were alternated with layers of fuel (initially wood or coal). Calcined quicklime was drawn from the base of the kiln and further layers of fuel and stone were charged into the top of the

kiln. The thermal efficiencies of these designs were better than those of the earlier kilns, but were still poor, owing to the incomplete combustion of the volatile matter. Use of coke overcame this problem and high thermal efficiencies were obtained. A large number of shaft kilns were developed [16]. Kiln outputs were often increased by the use of fans to increase the gas and air flows.

Most of the kilns in current use are based on either the vertical shaft or on the rotary design. There are a few other kilns based on different principles. All of these designs incorporate the concept of the three zones. In some kilns, they are incorporated into one unit, in others they exist as separate units (Figure 56.13).

**Vertical Shaft Designs.** Figure 56.8 shows a schematic of a vertical shaft kiln. The major problem with shaft kilns is obtaining uniform heat release across the shaft. Fuel injected at a wall usually does not penetrate more than 1 m into a packed bed. This limits the kiln width (or diameter) to 2 m. Increased fuel penetration can be achieved in larger shafts by:

- use of the mixed feed technique,
- use of central burners or lances,
- injecting the fuel via tuyères which penetrate ca. 1 m into the kiln,
- injection of the fuel underneath arches, or
- injection of air or recycled kiln gas above the fuel.

In general, vertical shaft kilns have relatively low heat usages because of efficient heat transfer between the gases and the packed bed. However, they retain most of the sulfur in the fuel so that low-sulfur quicklime can only be produced if a low-sulfur (and generally expensive) fuel is used to calcine a low-sulfur stone. Older designs tend to produce quicklime with a low to moderate reactivity and a relatively high  $\text{CaCO}_3$  content. Modern designs incorporate features which enable highly reactive lime to be produced with low  $\text{CaCO}_3$  levels. The four designs which are used extensively throughout the world are described below.

**Mixed-Feed Shaft Kiln.** Modern mixed-feed kilns use limestone with a top size in the range 5 to 15 cm and a size ratio of ca. 2:1. The most widely used fuel is a dense grade of coke with low reactivity and low ash content. The coke size is only slightly smaller than that of the stone so that it moves with it rather than trickling through the interstices. The stone and coke are mixed together and are charged into the kiln in such a way as to minimize segregation.

The net heat usage can be very low at ca. 3560 kJ/kg (850 kcal/kg). This advantage is offset by the high cost of coke compared to competitive fuels. Another advantage of the mixed-feed shaft kiln is that it produces kiln gas with a very high  $\text{CO}_2$  content. For processes which can use both the quicklime and the  $\text{CO}_2$  (e.g., the precipitated calcium carbonate process, the Solvay process, and the sugar beet process), this is an important factor in the overall economics.

The quality of the quicklime tends to be moderate, with the reactivity being considerably lower than that obtained by rotary kilns at the same  $\text{CaCO}_3$  level. This, however, can be an advantage for certain uses. The retention of sulfur from the fuel is high.

**Double-Inclined Shaft Kiln.** In the double-inclined kilns (Figure 56.9), the stone moves downwards under gravity past an upper and then a lower hearth, both of which are inclined at about 60°. Opposite each hearth are burners mounted underneath arches. The products of combustion and calcination travel upwards through the stone and are removed by an exhaust fan. Most of the combustion air is drawn through the cooling zone.

These kilns accept stone with a top size as low as 2 cm and as large as 10 cm. They produce a reactive, low-carbonate quicklime at a net heat usage of about 4600 kJ/kg (1100 kcal/kg). Although various fuels can be used, they should be selected to avoid excessive build-ups caused by fuel ash and calcium sulfate deposits.

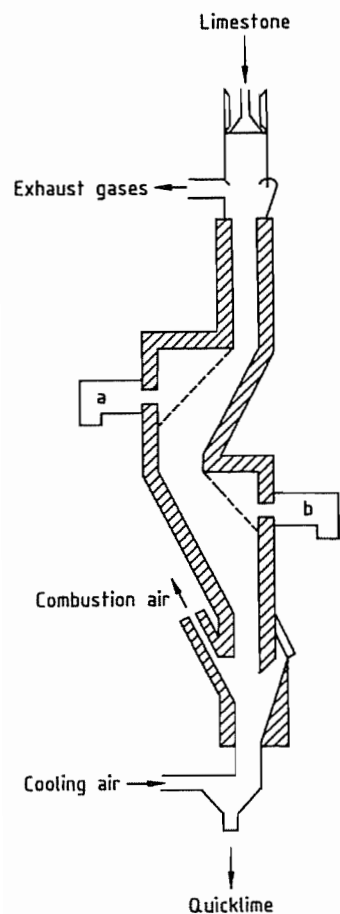

Figure 56.9: Schematic of a double-inclined shaft kiln: a) Upper burners; b) Lower burners.

**Annular Shaft Kiln.** The major feature of the annular shaft kiln (Figure 56.10) is a central cylinder which restricts the width of the annulus, and ensures good heat distribution. The central column also enables part of the combustion gases from the lower burners to be drawn down the shaft and to be injected back into the lower burner chamber. This recycle moderates the temperature at the lower burners and ensures that the final stages of calcination occur at low temperature. Both effects help to manufacture a product with a low  $\text{CaCO}_3$  level and high reactivity.

The annular shaft kiln accepts stone with a top size of 5–11 cm. Use of a heat recuperator,

in which 30% of the kiln gases are used to pre-heat part of the combustion air, reduces the net heat usage to about 4180 kJ/kg (1000 kcal/kg). The kiln can be fired by gas, oil, or solid fuel.

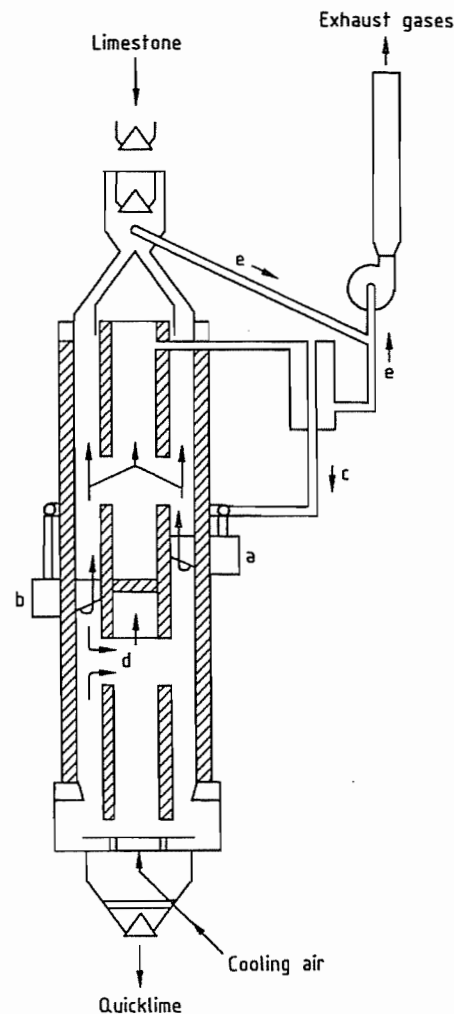

Figure 56.10: Schematic of an annular shaft kiln: a) Upper burners; b) Lower burners; c) Combustion air to upper burners; d) Combustion air to lower burners; e) Kiln gases.

**Parallel-Flow Regenerative Kiln.** The parallel-flow regenerative (or Maerz) kiln (Figures 56.11 and 56.12) consists of two or three interconnected vertical shafts. The following description relates to the two-shafted design.

The operation consists of two equal stages, which last about 12 min.

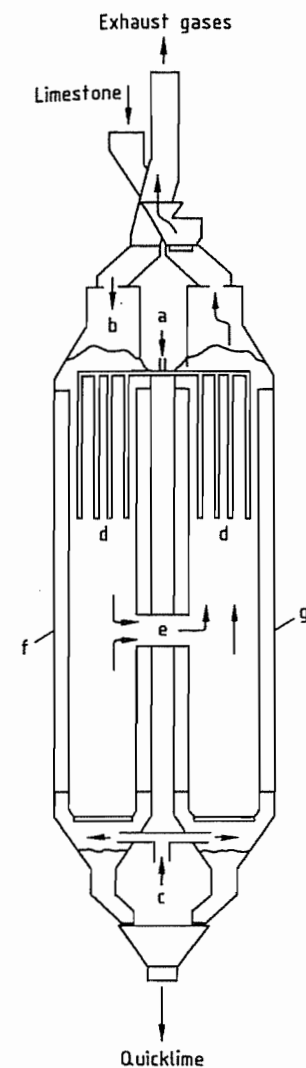

Figure 56.11: Schematic of a parallel-flow regenerative kiln: a) Fuel; b) Combustion air; c) Cooling air; d) Lances; e) Cross-duct; f) Shaft 1; g) Shaft 2.

In the first stage, fuel is injected through lances into shaft 1 and burns with combustion air blown down the shaft. The heat released is partly absorbed by calcining the limestone in shaft 1. Air is blown into the base of each shaft to cool the lime. The air in shaft 1 mixes with the combustion gases, including the carbon di-

oxide from calcination. The mixture passes through the cross-duct into shaft 2, at about 1050 °C. In shaft 2, the gases from shaft 1 mix with the cooling air blown into shaft 2 and pass upwards. In so doing, they heat the stone in the pre-heating zone of that shaft.

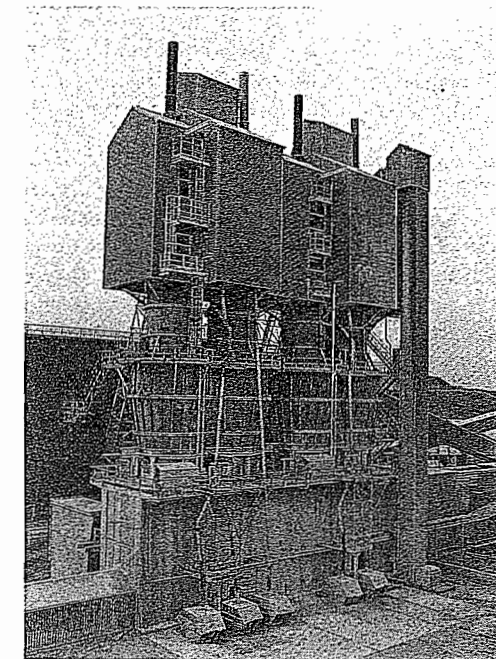

Figure 56.12: Two 300 t/d parallel-flow regenerative kilns.

During the second stage of the operation, the converse applies. The same amounts of fuel and combustion air are added to shaft 2. The combustion gases plus cooling air pass upwards in shaft 1, heating the stone in the pre-heating zone of that shaft.

The two key principles of the above operation are:

- The stone-packed preheating zone in each shaft acts as a regenerative heat exchanger in addition to pre-heating the stone to calcining temperature. The surplus heat in the gases is transferred to the stone in shaft 2 during the first stage. It is then transferred from the stone to the combustion air in the second stage. As a result, the combustion air is preheated to about 800 °C. The net heat

usage of the kiln is very low at below 3770 kJ/kg (900 kcal/kg) of quicklime.

- The calcination of the quicklime is completed at the level of the cross-duct at a moderate temperature of about 1100 °C. This favors the production of a highly reactive quicklime, which may, if required, be produced with a low CaCO<sub>3</sub> content. The kiln accepts stone with a top size of 5–12 cm, and it can be fired with gas, oil, or solid fuel.

**Rotary Kilns.** There are many designs and variants of the rotary kiln (Figure 56.13). Most use a feedstone with a top size in the range 1 to 6 cm. They operate well on gaseous, liquid, or solid fuels.

Heat usages for rotary kilns are generally much higher than those of shaft kilns and their capital costs tend to be higher. These adverse factors are often offset by their ability to produce a high-quality quicklime with lower CaCO<sub>3</sub> and sulfur levels and high reactivity, when fired by less expensive fuels.

In the earliest rotary kilns, stone was charged into the elevated end of the rotating section (generally inclined at about 4°). It was preheated by the gases drawn from the calcining zone at the other end of the kiln, and then calcined as it moved towards and under the

flame. The hot lime was then discharged into a pit to cool.

In later designs, the thermal efficiency of the rotary kiln is improved by:

- fitting lime coolers which preheat the combustion air,
- fitting raised sections of refractory (i.e., dams or mixers) in the calcining zone to improve heat transfer,
- installing refractory trefoils, metal lifters, or similar devices in the pre-heating zone of the rotating section, or
- using a stone pre-heater, followed by a shorter rotary section.

Net heat usages of rotary kilns range from over 8370 kJ/kg (2000 kcal/kg) for the simplest gas-fired units, to about 5020 kJ/kg (1200 kcal/kg) for the more complex coal-fired installations.

One complication often associated with rotary kilns is the build-up of “rings” on the refractory material in the rotary section. They are produced by the combination of lime dust with clay, ash (if present), and sodium and potassium salts. They can be particularly troublesome in kilns fitted with preheaters and in coal-fired kilns. In the latter case, fine grinding of a well selected coal generally minimizes ring formation.

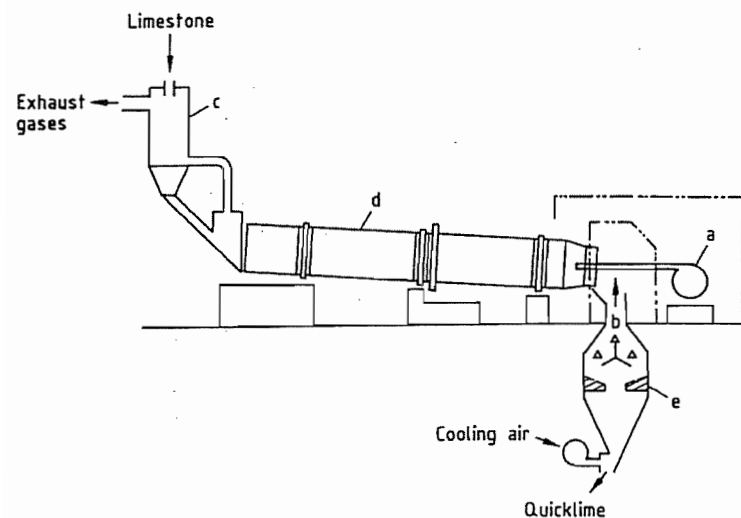

Figure 56.13: Schematic of a rotary kiln: a) Burner; b) Combustion air; c) Preheater; d) Kiln; e) Cooler.

A particular advantage of rotary kilns without preheaters is that it is possible to eliminate most of the sulfur introduced with the fuel. This enables low-sulfur lime to be made with cheaper, high-sulfur fuels. Use of a preheater increases the contact between the combustion gases and the partially calcined stone, increases the absorption of sulfur dioxide, and reduces the ability to eliminate sulfur. Calcium sulfate build-ups in the kiln or in the preheater can be troublesome.

Many lime producers have found that rotary kilns complement shaft kilns, because they use a smaller feedstone and produce quicklimes with different characteristics, which meet the requirements of certain customers.

**Other Kilns.** Various designs of lime kilns have been developed, based on the technology used in modern cement kilns. These accept small sizes of stone, e.g., below 0.6 cm, and carry out the calcination in fluidized beds or in a high-temperature gas stream by means of refractory-lined cyclones. They have not, as yet, proved to be viable.

The rotary hearth, or Calcimatic, kiln challenged the rotary kilns in the late 1960s and early 1970s, but generally failed to match them as they became more sophisticated and more economical.

**Dolime Kilns.** Dolomite is calcined in both shaft and rotary kilns. The principles of making lightly burned dolime are similar to those of making quicklime. Heat usages are lower owing to the lower heat of calcination and the lower calcination temperature of MgCO<sub>3</sub>.

Dead-burned dolomite for brick making is generally produced in mixed-feed, coke-fired shaft kilns and in coal-fired rotary kilns, at temperatures of about 1800 °C, to give a density of 3.2 g/cm<sup>3</sup>. It should be low in iron content.

When dolime is used for fettling purposes to protect the refractory lining of steelmaking vessels, 5–10% of iron oxide may be added and the product is sintered at 1400–1600 °C [6, 17].

### Quicklime Processing

The major demand is for the screened grades of quicklime in the range 4 to 0.6 cm. To obtain the maximum yield of those sizes, particularly from shaft kilns, it is generally necessary to crush the lime. Roll crushers are often used because they minimize formation of fines. Surplus grades (generally <0.6 cm) are often used as feed for the production of hydrated lime or ground quicklime.

The production of finely ground quicklime has expanded markedly in recent years. As various grades are required, ranging from 30 to over 99% passing 75 μm, they are generally produced in mills fitted with a variable speed classifier which returns coarse particles to the mill and controls the fineness of the finished product.

#### 56.5.3.4 Uses and Specifications

**Iron and Steel.** A small amount of lime is used in the production of iron ore agglomerates from fines. The main advantage of adding 1 to 6% of quicklime to the ore is a marked increase in the production capacity of the sinter strand. Ground quicklime is also used for the desulfurization of iron in the ladle before charging into the steelmaking furnace.

The major use of quicklime, however, is in the Basic Oxygen Steelmaking Process. Its usage varies from about 35 to 70 kg/t of steel. The quicklime neutralizes the acidic oxides, SiO<sub>2</sub>, Al<sub>2</sub>O<sub>3</sub>, and Fe<sub>2</sub>O<sub>3</sub>, to produce a basic molten slag. Correct formation of the slag is essential for the refining process.

A typical U.K. specification for steelmaking-quality quicklime is given in Table 56.5. The CaCO<sub>3</sub> content is limited to avoid excessive cooling of the melt through its decomposition to quicklime. The specifications for SiO<sub>2</sub> content and neutralizing value ensure that the quicklime has a high effective CaO content (1% of SiO<sub>2</sub> neutralizes about 2.8% of CaO). The grading and reactivity requirements ensure that the quicklime has an adequate surface area and reacts rapidly to

produce the slag without excessive loss of fines from the vessel.

**Table 56.5:** Quicklime specification for BOX steelmaking.

| Specification                           | Criterion                 | Value |
|---|---------------------------|-------|
| Sulfur                                  | max. average              | 0.03% |
|   | maximum                   | 0.05% |
| Neutralizing value (CaO)                | min. average              | 95.0% |
|   | at least 95% greater than | 93.0% |
| Silica (SiO <sub>2</sub> )              | max. average              | 1.0%  |
|   | maximum                   | 1.5%  |
| Loss on ignition due to CO <sub>2</sub> | max. average              | 2.0%  |
|   | at least 95% less than    | 2.5%  |
|   | maximum                   | 3.0%  |
| Reactivity (BS 6463)                    | minimum                   | 46 °C |
| Grading                                 | nominal top size          | 38 mm |
|   | nominal bottom size       | 5 mm  |
|   | max. amount passing 3 mm  | 10%   |

Further information on the role of quicklime and the slag in removing phosphorus and sulfur from steel is given in the literature [18].

Calcined dolomite is also added to the BOS vessel to give about 6% MgO in the slag, thereby reducing slag viscosity and attack of the basic refractory lining.

The electric arc steelmaking process uses quicklime to react with acidic oxides and produce a molten slag. The specification is similar to that for the BOS process.

Quicklime is also used in the argon oxygen decarburization process, for which a -1.5 +0.6 cm product is required with less than 0.15% C and 0.04% S.

**Calcium carbide** is produced by reacting quicklime [19] with coke in furnaces which are heated electrically to 2000 °C. It is used to produce acetylene by reaction with water. The by-product is an impure form of hydrated lime.

**Aerated Concrete.** Ground quicklime is used in the production of aerated concrete blocks, with densities of ca. 0.7 g/cm<sup>3</sup>. The quicklime is mixed with an active form of silicon (either ground silica sand or pulverized fuel ash), sand, water, aluminum powder and, depending on the quicklime quality, cement. The reaction of quicklime with aluminum powder generates hydrogen bubbles which cause the "cake"

to rise. At the same time the quicklime reacts with the water, generating heat and causing the cake to set. Close control of the process results in a green set, which enables the cake to be removed from the mold and cut into blocks before autoclaving at elevated temperature and pressure.

The key aspect of the quicklime specification for this use is consistent reactivity (which includes a measure of the total free lime content). The product should have at least 90% less than 75 μm and its MgO content should be less than 2%.

**Soil Stabilization.** Quicklime and hydrated lime can considerably increase the load carrying capacity of clay-containing soils. They do this by reacting with finely divided silica and alumina to produce calcium silicates and aluminates, which possess cementing properties.

Quicklime has the advantage over hydrated lime of drying out the soil. It does this by absorbing 30% of its own weight of moisture and also by generating heat which accelerates evaporation.

Soil stabilization is used in road and rail construction to strengthen subgrades, thereby reducing construction depths. It may also be used to produce a sub-base in place of aggregate. It is used on clay-rich construction sites for placement and compaction of on-site material. In some countries lime piling is used to pin unstable soils and to provide support for building slabs.

The U.K. specification for quicklime used in soil stabilization is given in a Department of Transport publication [20].

**Other Uses.** Small quantities of quicklime are used in other processes [6], e.g., the production of glass, calcium aluminate cement, and organic chemicals. About 50% of the total production, however, is converted to calcium hydroxide before use.

**Specifications.** Because of the dominance of steelmaking customers, most of the quicklime is produced to meet their chemical requirements. High reactivity is an advantage in soil stabilization. Consistent reactivity is essential

in the aerated concrete process. The particle size requirements often depend on the customers' handling, conveying, and blending systems.

## 56.5.4 Hydrated and Slaked Lime

### 56.5.4.1 Physical and Chemical Properties

**Color.** Most hydrated limes are white. High levels of impurity can result in a gray or buff color.

**Density.** High-calcium hydrated lime has a density of about 2.3 g/cm<sup>3</sup>. The values for partially and fully hydrated dolomitic lime are about 2.7 and 2.5 g/cm<sup>3</sup>, respectively.

**Bulk Density.** The compacted bulk density is in the range 550 to 650 kg/m<sup>3</sup>. In the as-poured state, it can be as low as 350 kg/m<sup>3</sup>, owing to air entrainment.

Specific surface area may be measured by air permeability [12], or by surface absorption of nitrogen (BET surface area). The former method generally gives areas of 1000–2000 m<sup>2</sup>/kg; the latter gives results which are some 20 to 30 times greater.

**Angle of Repose.** In the fluidized state, the angle of repose is 0°. In the compacted state, and particularly with 1% or more of excess water, the angle of repose can be over 80°. With bunker aeration, valley angles of 70° have proved to be satisfactory.

**Hardness.** This is between 2 and 3 Mohs.

**Specific Heat.** The specific heat of calcium hydroxide rises from 1130 Jkg<sup>-1</sup>K<sup>-1</sup> at 0 °C to 1550 Jkg<sup>-1</sup>K<sup>-1</sup> at 400 °C [21]. That of dolomitic hydrate is believed to be about 5% higher [6].

**Solubility.** This decreases from about 1.85 g Ca(OH)<sub>2</sub>/L water at 0 °C to 0.71 g/L at 100 °C for commercial calcium hydroxide, depending on impurity levels [22].

Some inorganic compounds affect the solubility [23]. Calcium sulfate is of particular interest; a 2 g/L solution reduces the solubility to

0.06 g Ca(OH)<sub>2</sub>/L. Organic compounds can increase the "solubility" of calcium hydroxide. Sugar has the greatest effect, as a result of the formation of calcium saccharate [23].

Magnesium hydroxide is only sparingly soluble in water (ca. 0.01 g/L) [24].

**Carbon Dioxide.** Calcium hydroxide reacts readily with carbon dioxide in the absence of water at temperatures below its dissociation point (ca. 540 °C). The reaction of quicklime with carbon dioxide below 300 °C only proceeds in the presence of some water vapor via formation of calcium hydroxide.

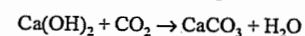
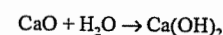

**Acid Neutralization.** Hydrated lime, whether Ca(OH)<sub>2</sub>, Ca(OH)<sub>2</sub>·MgO, or Ca(OH)<sub>2</sub>·Mg(OH)<sub>2</sub>, reacts readily with acids and acidic gases. The rate of reaction depends in part on the particle size of the hydrated lime.

**Silica and Alumina.** Hydrated lime reacts with pozzolans (materials containing reactive silica and alumina) in the presence of water to produce hydrated calcium silicates and aluminates. The reactions may take months to proceed to completion at ambient temperatures (e.g., in mortars and soil stabilization), but proceed within hours at elevated temperature and water vapor pressures (e.g., at 180 °C and a steam pressure of 1 MPa). This pozzolanic reaction is the basis of the strength generated by hydraulic quicklime.

**pH.** Because calcium hydroxide is a strong base, a concentration of 0.1 g Ca(OH)<sub>2</sub>/L gives a pH of about 11.3 at 25 °C. A saturated solution at 25 °C, containing 1.8 g/L, gives a pH of 12.45. Magnesium hydroxide gives a pH of about 10.5, owing to its lower solubility. The pH of dolomitic hydrate is dominated by its Ca(OH)<sub>2</sub> content and is similar to that of calcium hydroxide.

**Thermal Dissociation.** Calcium hydroxide decomposes at about 540 °C to quicklime and water. The quicklime so produced has an exceptionally high reactivity to water.

**Causticization.** Hydrated lime reacts with soluble metal carbonates to produce insoluble calcium carbonate and the metal hydroxide. This reaction is used to produce caustic soda (see Section 56.5.4.4).

#### 56.5.4.2 Raw Materials

##### *Raw Materials For Dry Hydrated Lime*

Dry hydrated lime can be produced from any quicklime. In commercial practice, however, the quicklime quality should be within well-defined limits to enable the processing plant to be selected to produce salable products economically.

**Reactivity.** The reactivity of the quicklime should be compatible with the characteristics of the plant.

Thus highly reactive quicklime (over 55 °C, BS 6463) tends to produce a water-burned gritty hydrate with a particle size up to 3 mm. The grit is believed to be formed by very rapid hydration on the surface of a quicklime particle, leading to the production of a putty which bakes into a hard layer and holds the particle together. If the plant includes a mill which has the capacity to grind the product to substantially less than 75 μm, such grit does not present any quality problems.

Quicklime of intermediate reactivity (30–55 °C, BS 6463) generally hydrates well, providing it is given adequate residence time in the hydrator.

Quicklime of low reactivity (below 30 °C, BS 6463) also tends to produce a gritty hydrate, unless given a long residence time. This grit consists largely of particles of unreacted solid-burned lime with a coating of hydrate. This must be ground to substantially less than 75 μm and returned to the hydrator if a fully hydrated product is required. Any free lime eventually hydrates and expands. This can cause expansion in, for example, sand-lime bricks, and may result in cracking, surface defects, and unsoundness in, for instance, plaster.

**Calcium Carbonate.** The permissible CaCO<sub>3</sub> content of the feed quicklime depends on the ability of the plant to reject a fraction rich in CaCO<sub>3</sub> and on the CaCO<sub>3</sub> specification for the finished hydrated lime. In some cases, with a hydrated lime specification of 2% CaCO<sub>3</sub>, feed quicklime CaCO<sub>3</sub> levels of up to 10% can be accepted; in others the level must be below 2.6%. The CaCO<sub>3</sub> is removed by screening or air classification.

**Particle Size.** The particle size of the quicklime fed to hydrators is generally below 5 cm and sometimes as low as 0.6 cm, depending on the design of the plant.

**Magnesium Oxide.** As MgO does not hydrate readily, the normal hydration process does not convert it to the hydrate. Providing the MgO content is below about 2%, the consequent unsoundness and expansion potential do not present problems. Higher MgO contents limit the markets into which the hydrated lime can be sold. Quicklimes with high MgO contents are often hydrated in the autoclave process, which produces a fully hydrated product with a high plasticity.

**Other Impurities.** Some customers place limits on the permissible levels of impurities in hydrated lime, which in turn place constraints on the impurities in the feed lime. These include lead, iron, silicon, and fluorine (see Section 56.5.4.4).

##### *Raw Materials For Slaked Lime*

In the slaking process, quicklime is reacted with a controlled excess of water to produce a milk or putty. The quicklime should be of a quality which gives the required quality of milk or putty, and which is compatible with the slaker used.

**Reactivity.** It is generally necessary to specify the reactivity to match the characteristics of the slaker and to obtain the required physical properties of the milk or putty.

**Calcium Carbonate.** Although many slakers remove grit rich in CaCO<sub>3</sub> by settling or filtration, their capacity to do so is limited. There-

fore, the CaCO<sub>3</sub> content should also be limited. In other slakers, most or all of the CaCO<sub>3</sub> in the quicklime is included in the slaked lime; its content should be limited according to the acceptable level in the slaked lime.

**Particle Size.** This is generally determined by the handling and processing equipment. In some cases a –2 cm quicklime is required. In others a ground quicklime is specified.

**Magnesium Oxide.** In applications where unsoundness or expansion potentials must be low, the MgO content in the quicklime should be below 2%.

**Water.** The presence of impurities in water can have a marked effect on the reaction of quicklime with water in the reactivity test (see Section 56.5.6). However, water quality does not generally affect the industrial production of slaked lime.

Restrictions on other impurities in the quicklime are as for the production of dry hydrated lime.

#### 56.5.4.3 Production

##### *Normal Hydration Process*

The normal hydration process, leading to the production of Type N hydrate, as defined in ASTM specification C-207 [7], is carried out at atmospheric pressure and ca. 100 °C. There are many designs of equipment, the choice of which depends on the reactivity and chemical purity of the quicklime, its particle size, and on the requirements for the finished product.

In a typical plant, the quicklime is mixed rapidly with about twice the stoichiometric amount of water in a premixer and is then passed into the main hydrating vessel, which is agitated and fitted with a weir at the discharge end to give an average solids residence time of 10–15 min.

As the hydration reaction proceeds, part of the water boils off vigorously, producing a partially fluidized bed. Coarse particles of

gritty hydrate or unreacted lime are retained behind the weir, while fine particles of hydrate flow over it. A purge paddle close to the weir prevents excessive build up of coarse particles by lifting them over the weir.

The raw hydrate is then conveyed along one or more tubes, which serve to complete the hydration and evaporate excess water. The hydrate is discharged at about 90 °C and contains less than 1% excess water.

The raw hydrate is fed to an air classifier, in which a recycling air stream removes fine particles into an outer settling chamber and allows coarse particles to fall to the base of the inner feed chamber. The fine particles make up the finished product. The coarse particles may then be rejected as a stream rich in CaCO<sub>3</sub>. Alternatively, they may be milled, with the product being recycled to the hydrator, added to the fines from the air classifier, or reclassified.

The steam generated in the hydrator, together with any air drawn into the process, may be de-dusted in a wet scrubber before discharge to the atmosphere, in which case the milk of lime from the scrubber is fed to the premixer.

Some plants use aging silos to retain damp hydrate at elevated temperature for about 24 h to increase the extent of hydration. They are generally used when the feed quicklime has a low reactivity; with dolomitic hydrate; or when a product with a particularly low expansion potential is required.

##### *Pressure Hydration Process*

Type S hydrate, as defined in ASTM specification C-207 [7], is produced by reacting quicklime (generally dolomitic) and water under a steam pressure of ca. 1 MPa and at a temperature of ca. 180 °C. After hydration the product is dried, milled, and air classified.

##### *Slaking*

There are many ways of slaking quicklime, ranging from the batch process to sophisticated continuous slakers.

In the batch process, water and quicklime are added as required to maintain the milk at about 90 °C. With reactive quicklime, care should be taken to avoid local overheating which can lead to water-burning and a gritty hydrate. With cold water, this technique produces a viscous suspension with 35–40% solids. Grit arising from uncalcined limestone and from unreacted and water-burned lime settles on the floor of the vessel.

There are various designs of continuous slakers, which produce either milk of lime or lime putty. Some feature automatic grit removal.

Slaking at ca. 90 °C produces the finely divided particles of calcium hydroxide required by most users. If the slaking temperature drops, e.g., to 70 °C, the resulting increase in particle size reduces both the viscosity and reaction rate.

Aging the slaked lime for 30 min generally ensures complete hydration. Aging for a day generally improves the physical properties, e.g., higher viscosity and greater workability.

Some operators achieve the same benefits by subjecting the slaked lime to high shear (e.g., by use of a colloid mill). Milk of lime produced in this way, with dispersing agents, may be stored in unstirred tanks.

#### 56.5.4.4 Uses and Specifications

##### Uses

In this Section, the term hydrated lime is used to describe both dry hydrate and slaked lime, unless otherwise specified.

There is little reliable information about the proportion of quicklime which is hydrated before use. The author's estimate for European countries is that it is roughly 50%, of which about one-third is initially converted into dry hydrated lime and two-thirds are initially slaked to give milk of lime or lime putty.

Hydrated lime is used in a large number of processes. The more important ones are described briefly below. More detailed information is available in the literature [6].

**The Solvay Process.** A key step in the Solvay (or ammonia–soda) process for the production of soda ash and sodium hydrogen carbonate is the recovery of ammonia from an ammonium chloride solution by reaction with milk of lime.

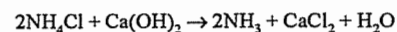

**Causticization.** Caustic soda is produced by reacting sodium carbonate with milk of lime. Before the development of the electrolytic cell, this was the normal method of production of caustic soda.

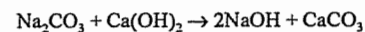

In addition to its use in the Bayer alumina process (see below) this reaction is used for the regeneration of caustic soda in wood pulp plants for the production of kraft or sulfate paper.

**Nonferrous Metallurgy.** Hydrated lime is used in the production of alumina by the Bayer process to regenerate sodium hydroxide from sodium carbonate solutions (see above). It is used in flotation processes to beneficiate copper ore and to extract gold and silver. It is an essential chemical for the extraction of uranium from gold slimes and for the recovery of nickel and tungsten after smelting.

Hydrated lime is used in the production of magnesia and magnesium metal. In the seawater processes, a high-calcium hydrate is used to precipitate magnesium hydroxide, while in the Dow natural brine process, dolomitic hydrated lime is used.

**Water Treatment.** Hydrated lime is used to remove temporary and permanent hardness. Calcium and magnesium hydrogen carbonates react with calcium hydroxide to produce insoluble calcium carbonate and magnesium hydroxide.

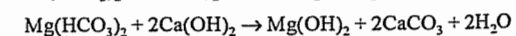
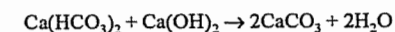

Permanent hardness caused by calcium and magnesium chlorides and sulfates can be removed by hydrated lime plus sodium carbonate.

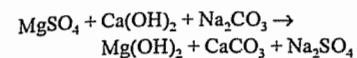
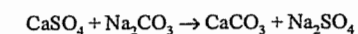

Water can be purified by raising the pH to above 11 for 1–2d, followed by recarbonation to pH 8–9. In addition to killing bacteria, this treatment removes temporary hardness. Acid water may be neutralized by the addition of lime. Specifications have been published for limes used in the United States for water treatment [19, 25]. A European standard is in preparation.

**Sewage Treatment.** Treatment of sewage sludge with hydrated lime in conjunction with ferrous sulfate is an effective way of removing solids and phosphorus compounds, and for destroying pathogens. It produces a sludge which dewateres well and can be used as a fertilizer.

**Industrial Wastes.** Hydrated lime is used widely to neutralize acid wastes and precipitate heavy metals in effluents from a wide range of industries. In some cases it is also used to assist with the clarification process.

**Flue Gas Desulfurization.** Of the many flue gas desulfurization processes, three use hydrated lime.

In the wet scrubbing process, milk of lime is sprayed through the gases. The product is a suspension of calcium sulfite, which may be oxidized to produce salable gypsum. Up to 95% removal of sulfur dioxide has been reported, with over 90% utilization of the hydrated lime [26].

In the dry scrubbing process, milk of lime is fed into a spray drier in which the product is a dry powder consisting of calcium sulfite and hydrated lime. Up to 85% removal of sulfur dioxide and 40–60% utilization of the hydrated lime have been obtained [26]. Sulfur dioxide may also be removed by injection of dry hydrate either into the boiler, or downstream from the boiler. The reaction products are collected with the fly ash for disposal. Only 50–60% of the sulfur dioxide is removed, and the utilization of normal hydrated lime is less than 40% [26]. Hydrated lime products, with

higher specific surface areas than those of normal hydrate, have been developed for this use.

**Sugar Refining.** In the refining of sugar beet, the crude solution of sugar is treated with milk of lime to precipitate calcium salts of organic and phosphoric acids. After filtering, the solution is neutralized with carbon dioxide, calcium carbonate is removed by filtration, and a purified sugar solution is produced.

As the process requires a large quantity of both lime (about 250 kg/t of sugar) and carbon dioxide, producers of sugar from beet generally operate their own lime kilns as part of their process.

Because cane sugar is purer, its refinement requires much less hydrated lime (typically 5 kg/t).

**Sand-Lime Bricks.** There is a substantial market in Europe for sand lime bricks. These are made by mixing hydrated lime with sand, followed by autoclaving for several hours under a steam pressure of ca. 1 MPa (180 °C). In some processes, it is essential that the hydrated lime is not expansive, because the expansion can occur in the autoclave and result in the production of oversize bricks.

**Mortars.** Hydrated lime is used in lime cement sand mortars in various proportions. The required compressive strength of the mortar is obtained by adjusting its composition [54]. The lime confers several benefits. It increases the plasticity and water retentivity of the wet mortar and increases the bond strength of the mortar to the masonry. The mortar is more flexible and less prone to cracking.

**Soil Stabilization.** Both dry hydrated lime and milk of lime are used in soil stabilization. Dry hydrate disperses readily when making a soil tilth. Milk of lime has advantages when the soil is dry; it can also be injected under pressure.

**Agriculture.** The advantages of adjusting soil pH with limestone are described in Section 56.5.2.4. Hydrated lime has the additional advantage of being quick acting.

**Bleaching.** Chlorine is reacted with hydrated lime to produce a powdered mixture of calcium hypochlorite and calcium chloride, commonly known as bleaching powder.

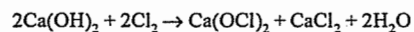

Calcium hypochlorite solution is used in bleaching wood pulp.

**Precipitated calcium carbonate (PCC)** is produced by blowing gases containing carbon dioxide through milk of lime. By controlling the conditions, a very finely divided calcium carbonate with a high reflexivity and a median particle size of 0.02–0.2  $\mu\text{m}$  is produced. Some PCCs are coated with compounds which facilitate their blending with organic substances (e.g., plastics and rubber).

**Inorganic Salts and Bases.** Hydrated lime is used in the production of mono-, di-, and tricalcium phosphates as well as other calcium salts. It is used in the Solvay process to produce calcium chloride as a by-product. Lithium and barium hydroxides are made by causticization.

The brine purification process uses sodium carbonate and milk of lime to remove dissolved calcium and magnesium.

**Other Uses.** There are a wide range of other uses such as the production of calcium silicate insulation products, plasters, lubricants, pigments, soda lime, organic compounds and calcium salts. Hydrated lime is also used in the petroleum industry, glass manufacture, solid waste disposal, and leather tanning [6].

### Specifications

In many countries, the most widely recognized specifications for dry hydrated lime relate to its use in building [7, 13, 27, 48]. These set minimum values for fineness, neutralizing value, and other properties. In practice, most dry hydrated limes meet these requirements with ease. A typical quality specification is given in Table 56.6.

**Table 56.6:** Typical specification for high-calcium hydrated lime.

| Specification                | Criterion    | Value              |
|------------------------------|--------------|--------------------|
| Carbon dioxide               | maximum      | 6% <sup>a</sup>    |
| Acid insoluble matter        | maximum      | 1% <sup>a</sup>    |
| CaO + MgO                    | minimum      | 65% <sup>a</sup>   |
| MgO                          | maximum      | 4% <sup>a</sup>    |
| Residue on 200 $\mu\text{m}$ | maximum      | 2% <sup>a</sup>    |
| 90 $\mu\text{m}$             | maximum      | 7% <sup>a</sup>    |
| Soundness expansion          | maximum      | 20 mm <sup>a</sup> |
| pat test                     | pops or pits | nil                |
| Excess moisture              | maximum      | 1%                 |

<sup>a</sup> As required by BS 890 (1995).

Some end uses require especially low levels of impurities such as silica, iron oxide, magnesium oxide, and fluoride. Others require uniform surface areas.

Dry hydrated lime for use in the production of sand lime bricks should have an expansion below 1.0 cm [27] and less than 4% MgO (unless it is Type S).

### 56.5.5 Environmental Protection

**Standards.** The emission of dust from stone processing, lime kilns, and solids handling is often the major environmental problem associated with the production of lime and limestone products.

In many countries, emissions of dust to the atmosphere are limited to below 50 mg of solids per cubic meter (at 0 °C and 101 MPa) of exhaust gas or air.

In the United Kingdom, the Pollution Inspectorate gives practical advice on control methods for all aspects of limestone processing and the production of quicklime and hydrated lime [28, 29].

**Equipment.** A variety of techniques are used to control dust emissions from stone processing operations. Dust suppression, which uses water with a wetting agent to cause dust to adhere to larger particles, can be an effective and inexpensive method. It may, however, cause undesirable surface contamination of screened products with fines and increase downstream dust problems.

As the effluent gases from stone processing and local exhaust ventilation systems are generally at relatively low temperatures, bag filters or high-energy wet scrubbers are widely used. The dust collected by bag filters can often be sold as a filler for concrete production.

The temperature of the effluent gases from lime kilns is commonly 200–400 °C. In the past, high efficiency multi-cyclones were widely used to collect the dust. They had the advantage of being relatively inexpensive to install and operate. However, their efficiency is generally no longer adequate in the context of current emission requirements.

Electrostatic precipitators can handle gases at the above temperatures. Although their capital cost is high, their operating costs are moderate.

Gravel bed filters can be operated at high temperatures. They are efficient but have higher capital and operating costs than electrostatic precipitators. Consequently, they are not widely used.

Bag filters are widely used when the gas temperatures are below 200 °C. They are lower in capital cost than precipitators, have a high collection efficiency, but have high operating costs. The reverse-jet method of cleaning the bags has generally been found to be the most effective.

The dust collected from lime kilns is generally high in  $\text{CaCO}_3$  but is contaminated with quicklime and possibly fuel ash. It is usually tipped.

Wet collectors are not widely used with quicklime. They are, however, generally the preferred method of controlling dust from hydrating plants. The collected milk of lime is fed back to the process.

Dust collection from the handling, storage and loading of quicklime and hydrated lime generally involves bag filters. The collected dust usually has a high lime content and is sold.

## 56.5.6 Physical Testing and Chemical Analysis

### 56.5.6.1 Sampling and Sample Preparation

The most common cause of disagreement between laboratories arises from the failure to obtain representative samples. Sampling solids, and particularly granular solids made from naturally occurring minerals, is especially difficult. The problem is compounded when, as in the case of quicklime, the quality of the sample is affected by exposure to the atmosphere. In general, if quicklime contains 1% or more of combined water, it has not been correctly handled, and its reactivity to water will have been reduced.

Guidance on the sampling of limestone, quicklime, and hydrated lime is given in BS 6463, Part 1 [12]. Similar advice is given in ASTM D 75 for limestone and in ASTM C 110 and C 50 for lime products [14, 30, 31]. The sampling of aggregate and the reproducibility and repeatability of test results is described in BS 812, Parts 1, 101, and 102 [32].

Samples should be taken from a falling stream whenever possible. Precautions should be taken to ensure that segregation within the stream does not lead to bias. Samples may also be taken from conveyor belts; precautions are required to obtain a representative sample. It is very difficult to obtain a representative sample from the body of a truck or from a stockpile. Careful checks should therefore be made to establish whether the sampling method is valid.

Each sample should consist of not less than 10 increments. Each increment should be of an adequate volume (e.g., 10 L for lumps with a maximum size of 10 cm, decreasing to 2 L for a maximum size of 1 cm, and to 1 L for powders). There are many mechanical aids to sampling ranging from augers to automatic samplers [33].

Some physical tests are performed on the sample as taken. For other physical tests and for chemical analysis, it is necessary to crush,



subdivide and pulverize the product to less than 300  $\mu\text{m}$ . This should be done on a separate sample from that used for the physical tests, and in such a way as to avoid bias and, in the case of quicklime and hydrated lime, to avoid excessive exposure to the atmosphere.

All quicklime and hydrated lime samples should be stored in well sealed containers or bags. It is good practice to double-wrap samples which are to be stored for prolonged periods. Quicklime should not be stored in a desiccator because it removes water from some commonly used desiccants.

### 56.5.6.2 Physical Testing

**Limestone.** In the United Kingdom, limestone is generally processed to meet either BS 882 (Aggregates from Natural Sources for Concrete) [34] or to BS 63, Part 1 (Road Aggregates) [35]. The latter is generally referred to in specifications for drainage material and for feed for tarmac coating plants. Most of the physical tests are described in BS 812, Parts 1–4 [32].

The susceptibility of crushed stone to frost damage may be tested using a Road Research Laboratory method [36]. With regard to resistance to the alkali silica reaction, the cause of so-called concrete cancer, limestone is generally regarded as being inert. Requirements for coated macadams are given in BS 4987 [37], which includes their composition, manufacture, testing, and transport. Corresponding U.S. methods are available [6].

**Quicklime and Hydrated Lime.** Physical test methods for quicklime and hydrated lime are given in BS 6463 [12]. The corresponding U.S. standard is ASTM C 110 [14]. Test methods for building limes are given in European standard DD ENV 459-1 [48].

### 56.5.6.3 Chemical Analysis

The methods for chemical analysis of limestone, quicklime, and hydrated lime are closely related and are described in BS 6463, Part 2. The corresponding U.S. standard is

ASTM C 25 [38]; DIN 1060, Part 2 [13] relates to building limes.

Increasingly, test methods using atomic spectrometry are being used for the analysis of minor components and trace elements, e.g., [49, 50].

### 56.5.7 Storage and Transportation

**Limestone.** Screened sizes of limestone are stored in bunkers and in outside stockpiles. Fine grades are generally stored in sealed bunkers.

As most screened limestone is distributed to a large number of sites, generally within 40–80 km of the quarry, it is mainly transported in sheeted tipper road vehicles. Use of rail or water transport becomes more economic as the volume of business to a given site increases and as the distance becomes greater. It has been estimated that over 75% of limestone is transported by road [6]. Fine grades of limestone are transported by air pressure discharge vehicles, generally by road, but suitable railroad cars are also available.

**Quicklime.** Quicklime is stored in enclosed bunkers with well-sealed discharge mechanisms to minimise the reaction with atmospheric water and carbon dioxide and to control dust emission. Storage capacities equivalent to 2 to 5 days' production are usually necessary.

Screened grades of quicklime (generally 0.5 cm and above) may be transported in tipper trucks. Effective sheeting is essential to minimize atmospheric attack on the quicklime and to control dust emission. Air pressure discharge vehicles are used to transport fine grades of quicklime (below 0.5 cm) and, increasingly, screened grades up to 2 cm. Where appropriate, use of rail or water transport can extend the economic delivery distance.

A small amount of quicklime is packaged. Plastic containers and sacks are used for amounts up to 50 kg. Intermediate bulk containers, both rigid and flexible, are being used increasingly for quantities up to 1 t. There is a

small international market for packaged quicklime.

Where totally enclosed bunkers cannot be provided, quicklime should be stored on a concrete base, preferably in a separate bay within a building. It should be used as soon as possible after delivery. It can be kept longer by covering the pile with a close-fitting impermeable sheet. Open reception hoppers should be protected from the elements.

Contact of quicklime with flammable materials should be avoided, especially when there is a risk of water penetration. The heat of hydration has been known to cause fires.

Further details on the delivery, storage and handling of quicklime are often available from the supplier, for example [39].

**Hydrated Lime.** Hydrated lime is stored in enclosed silos to minimize reaction with atmospheric carbon dioxide and to control dust emissions.

Most hydrated lime is transported in air pressure discharge vehicles, both by road and rail. A substantial amount, however, is sold in paper sacks (generally 25 kg in the United Kingdom) Use of intermediate bulk containers holding up to 1 t is increasing. There is a significant international market for packaged hydrate.

The flow characteristics of hydrated lime are very variable. The angle of repose varies from 0–80° according to the amounts of entrained air and excess water, and other factors. Silos may need to be fitted with devices to cope with bridging of the powder above discharge points and to encourage flow (e.g., bin activators and air pads).

Hydrated lime in paper sacks is generally placed on pallets and stored under cover. By fitting impermeable slip sheets under the bags and shrink wrapping a cover over the loaded pallet, it may be stored out of doors for several months.

Further details on the delivery, storage and handling of hydrated lime are often available from the supplier, for example [40].

### 56.5.8 Economic Aspects

Statistics on the production of limestone are not widely available and are often complicated by the inclusion of other crushed rock. The United States is probably the largest producer with over  $700 \times 10^6$  t/a. Russia is believed to produce ca.  $500 \times 10^6$  t/a, and Japan  $200 \times 10^6$  t/a. Production in the United Kingdom is about  $120 \times 10^6$  t/a.

The major uses of limestone (including chalk) in the United Kingdom and United States are compared in Table 56.7 [41, 51].

The quantities of dense, high-calcium limestone, dolomite, and chalk consumed in the United Kingdom by the main user industries are given in Table 56.8 [42].

The ex-works price for construction stone in the United Kingdom is in the range £1–5/t (1996). Chemical quality limestone for lime burning and glass manufacture commands higher ex-works prices.

Ground limestone products, often known as whitening, can command prices of £20–200/t, depending on grading and quality. Precipitated calcium carbonate is a specialist chemical which sells for £200–1000/t (1996).

Table 56.7: Main uses of limestone.

| Use  | Market share, % |            |
|--|-----------------|------------|
|  | UK (1993)       | USA (1987) |
| Construction (mainly concrete and roadstone) | 79              | 75         |
| Cement                                       | 8               | 10         |
| Lime (including dead-burned dolomite)        | 4               | 4          |
| Agriculture                                  | 2               | 5          |
| Flux stone (mainly for iron production)      | 2               | 3          |
| Other  | 5               | 3          |

Table 56.8: Consumption of limestone, in the United Kingdom (1986).

| 1                                    | Dense, high calcium limestone, $10^6$ t/a | Dolomite, $10^6$ t/a | Chalk, $10^6$ t/a | Total, $10^6$ t/a |
|--------------------------------------|---|----------------------|-------------------|-------------------|
| Construction                         | 65.9                                      | 12.7                 | 0.9               | 79.5              |
| Cement                               | 9.1                                       | 0                    | 9.6               | 18.7              |
| Agriculture                          | 1.3                                       | 1.2                  | 0.6               | 3.1               |
| Iron, steel, chemical and other uses | 4.9                                       | 1.7                  | 1.0               | 7.6               |
| Total                                | 81.2                                      | 15.6                 | 12.1              | 108.9             |

**Table 56.9:** Estimated world quicklime production, 1994.

| Country             | Production, 10 <sup>6</sup> t/a |
|---------------------|---------------------------------|
| Former Soviet Union | 20.0                            |
| China               | 19.5                            |
| United States       | 17.1                            |
| Japan               | 10.5                            |
| Germany             | 6.6                             |
| Brazil              | 5.7                             |
| Italy               | 4.4                             |
| Mexico              | 4.0                             |
| Romania             | 3.0                             |
| France              | 2.2                             |
| Belgium             | 2.1                             |
| United Kingdom      | 1.3                             |
| Others              | 23.2                            |
| <b>Total</b>        | <b>122.2</b>                    |

**Table 56.10:** Main uses of quicklime.

| Use                     | Percentage of total market |       |         |        |                |
|-------------------------|----------------------------|-------|---------|--------|----------------|
|                         | United States              | Japan | Germany | France | United Kingdom |
| Steel and iron          | 41                         | 49    | 36      | 55     | 36             |
| Chemical and industrial | 36                         | 27    | 23      | 23     | 34             |
| Construction and roads  | 7                          | 7     | 26      | 9      | 11             |
| Agricultural            | < 1                        | 3     | 6       | 9      | ] 19           |
| Refractories            | 5                          | ] 14  | ] 9     | ] 4    |                |
| Other                   | 11                         |       |         |        |                |

The estimated production of quicklime (including hydrated lime) in various countries is given in Table 56.9 [51, 52]. The total is just over  $100 \times 10^6$  t/a. The major producers are the former Soviet Union, China, United States, and Japan.

Comparison of statistics on uses of quicklime for different countries is complicated by the use of different classifications. Table 56.10 lists information from various sources [17, 41, 42] for five countries. In all five, the iron and steel industry dominates the market. There are a large number of uses in the chemical and construction industries (including building), as well as in general industry.

The ex-works price of lime products in the United Kingdom is generally in the range £30–60/t (1996). Specialist products, which are tailored to the needs of individual markets, generally command higher prices. The prices of ground quicklime and hydrated lime are

typically some 25% higher than screened quicklime and reflect the capital and operating costs of the additional processing stage.

## 56.5.9 Toxicology and Occupational Health

### 56.5.9.1 Toxicology

**Limestone.** Limestone is a practically non-harmful material. It is regarded as a nuisance dust and has a recommended occupational exposure limit of 10 mg/m<sup>3</sup> for total, and 5 mg/m<sup>3</sup> for respirable dust [43]. These limits are not affected by the presence of crystalline silica at levels below 1%. Lower limits may apply at higher silica levels. The subject is under review.

The dust may irritate the eyes and cause discomfort. It is nonirritant to the skin. Exposure to high levels of dust can cause discomfort as a result of its drying effect on the mouth and upper respiratory tract.

Calcium carbonate is a recognized ingredient of human and animal foodstuffs. It is used as an antacid. The therapeutic dose is 1–5 g. Chronic effects are unlikely to be encountered in industry. There are no occupational diseases known to be connected with the handling of limestone.

**Quicklime and Hydrated Lime.** The recommended occupational exposure limits for quicklime and hydrated lime (8-h TWA) are 2 mg/m<sup>3</sup> and 5 mg/m<sup>3</sup>, respectively, for total dust [43]. The dusts are irritant to the upper respiratory tract. Gross inhalation may result in inflammation of the respiratory passages, ulceration and perforation of the nasal septum, and possible pneumonitis. With minor exposures, only transitory effects may occur.

Quicklime and hydrated lime in the eye can be very painful and may cause chemical burns which could lead to impairment or total loss of vision if immediate attention is not received. Speed of treatment is essential.

Both products are irritant to the skin and cause chemical burns in the presence of moisture, including perspiration. Prolonged and re-

peated contact may cause the skin to become dry and cracked if proper care is neglected. They may cause dermatitis. Ingestion causes corrosion of, and damage to, the gastrointestinal tract.

### 56.5.9.2 Occupational Health

**Limestone.** The quarrying industry in general has a poor safety record. In the United Kingdom, the risk of a fatal accident in quarrying is ca. 17 times greater than that in manufacturing industry [44].

While the use of explosives is generally perceived to be the greatest hazard in quarrying, it causes less than 5% of the deaths and major injuries [45] and is generally well covered by legislation. Dump trucks, mechanical shovels, and other mobile equipment, however, are the cause of over half of the deaths and major injuries. This category includes falls associated with mobile equipment.

In limestone mines, rock falls account for about one-third of deaths and serious injuries, with haulage and transport being the next most significant category [46]. Special electrical precautions (e.g., high integrity earthing and use of low voltage portable tools) are essential as water percolates into most mines.

Stone processing involves a number of mechanical operations. The largest category of injuries caused by these processes generally arises from inadequate guarding of moving machinery and from failure to electrically isolate equipment when carrying out maintenance.

Stone processing generates high noise levels. Measures are required to reduce or contain the noise at source, or to exclude it from work areas. Use of television cameras and monitors can reduce the exposure of operators to high sound levels. Effective personal hearing protection is also required. In dusty areas, suitable respiratory and eye protection equipment should be used.

**Quicklime and Hydrated Lime.** The lime industry has a lower accident rate than quarry-

ing. Tripping and falling constitute the largest category of accidents [47].

Both quicklime and hydrated lime are dusty, alkaline products. A common injury associated with them is grit or dust in the eye. The use of adequate eye protection in all lime production and handling areas is essential. Eye wash facilities should be provided in all work areas so that the eye can be irrigated immediately.

Skin contact removes the natural oils and causes the skin to become dry. Sweating can result in chemical burns. Porous gloves protect the skin and reduce the risk of sweating. Use of skin cream after exposure helps to moisturize the skin.

Milk of lime, if splashed, presents a serious hazard to the eyes and skin. Use of suitable goggles, gloves and protective clothing is recommended.

Lime processing involves a number of mechanical operations. Adequate guarding of moving machinery and effective electrical isolation when carrying out maintenance are essential.

## 56.6 Calcium Sulfate

Both gypsum, CaSO<sub>4</sub>·2H<sub>2</sub>O, and anhydrite, CaSO<sub>4</sub>, are widely distributed in the earth's crust. Only in volcanic regions are gypsum and anhydrite rock completely absent. In addition, large quantities of gypsum and anhydrite are obtained from industrial processes when flue gases are desulfurized or calcium salts are reacted with sulfuric acid. In these cases calcium sulfate is usually obtained as a moist, fine powder.

Gypsum is useful as an industrial material because (1) it readily loses its water of hydration when heated, producing a partially or totally dehydrated calcined gypsum, it reverts to the original dihydrate — the set and hardened gypsum product. These two phenomena, dehydration and rehydration, are the basis of gypsum technology:

*Dehydration*

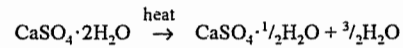

#### Rehydration

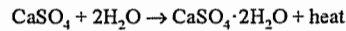
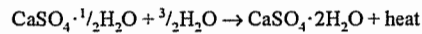

The apparent density of the rehydrated calcium sulfate is much lower, 0.5–1.5 t/m<sup>3</sup>, than the density of the calcium sulfate rock, 2.3 t/m<sup>3</sup>.

Gypsum and anhydrite are nontoxic.

Both gypsum plaster and lime were used as mortar in antiquity. Gypsum was called gatch in Persian, γυψος in Greek, and gypsum in Latin. Iranians, Egyptians, Babylonians, Greeks, and Romans were familiar with the art of working with gypsum plaster, examples being the walls of Jericho, the pyramid of Cheops, the palace of Knossos, and the decorated interior walls of Pompeii. In Germany gypsum plaster was used as mortar in walls and buildings during the early Middle Ages, e.g., the monastery at Walkenried in the Harz Mountains. It gained popularity tremendously, reaching its peak during the Baroque and Rococo periods. Examples are the Wessobrunn school for stucco workers [71] and the stucco decorations in Charlottenburg palace, Berlin. The expansion of the cement industry in the second half of the nineteenth century also considerably increased the use of gypsum.

Over the centuries the gypsum industry has developed empirically out of the old craft of gypsum plastering. The distinctions between gypsum plaster and lime, however, remained obscure up to the eighteenth century. Research into the principles of gypsum technology was begun in 1765 by LAVOISIER, and has continued to this day. However, a craft so firmly steeped in tradition was slow to accept scientific conclusions, and only in the last few decades has gypsum manufacture developed into a modern industry [55].

## 56.6.1 The CaSO<sub>4</sub>-H<sub>2</sub>O System

### 56.6.1.1 Phases

The CaSO<sub>4</sub>-H<sub>2</sub>O system is characterized by five solid phases. Four exist at room temperature: calcium sulfate dihydrate, calcium sulfate hemihydrate, anhydrite III, and anhydrite II. The fifth phase, anhydrite I, only exists above 1180 °C [72], and it has not proved possible to produce a stable form of anhydrite I below that temperature. Table 56.11 characterizes the phases in the CaSO<sub>4</sub>-H<sub>2</sub>O system. The first four phases are of interest to industry.

Calcium sulfate dihydrate, CaSO<sub>4</sub>·2H<sub>2</sub>O, is both the starting material before dehydration and the final product after rehydration. Calcium sulfate hemihydrate, CaSO<sub>4</sub>·½H<sub>2</sub>O, occurs in two different forms, α and β, representing two limiting states [74]. They differ from each other in their application characteristics, their heats of hydration, and their methods of preparation (see Table 56.18) [75]. The α-hemihydrate (Figure 56.14) consists of compact, well-formed, transparent, large primary particles. The β-hemihydrate (Figure 56.15) forms flaky, rugged secondary particles made up of extremely small crystals.

LEHMANN et al. [76] postulated three limiting stages for anhydrite III, also known as soluble anhydrite: β-anhydrite III, β-anhydrite III', and α-anhydrite III. The three stages of anhydrite III were characterized by X-ray analysis, differential thermal analysis, scanning electron microscopy, mercury porosimetry, and measurement of the specific surface area. Anhydrite II is the naturally occurring form and also that produced from calcining the dihydrate, hemihydrate, and anhydrite III at elevated temperature.

The most important physical properties of the calcium sulfate phases are shown in Table 56.12.

Table 56.11: Phases in the CaSO<sub>4</sub>-H<sub>2</sub>O system.

| Characteristic  | Calcium sulfate dihydrate   | Calcium sulfate hemihydrate  | Anhydrite III   | Anhydrite II  | Anhydrite I                |
|---|---|--|---|---|----------------------------|
| Formula   | CaSO <sub>4</sub> ·2H <sub>2</sub> O  | CaSO <sub>4</sub> ·½H <sub>2</sub> O   | CaSO <sub>4</sub>   | CaSO <sub>4</sub>   | CaSO <sub>4</sub>          |
| Thermodynamic stability, °C                           | < 40  | metastable <sup>a</sup>  | metastable <sup>b</sup>   | 40–1180   | > 1180                     |
| Forms or stages                                       |   | two forms: α, β  | three stages: β-anhydrite III, β-anhydrite III', α-anhydrite III    | three stages: AII-s, slowly soluble anhydrite, AII-u, insoluble anhydrite, AII-E, <i>Estrichgips</i>                |                            |
| Other names, often based on the application           | gypsum, raw gypsum, FGD gypsum, synthetic gypsum, chemical gypsum, by-product gypsum, set gypsum, hardened gypsum | α-form: α-hemihydrate, auto-clave plaster, α-plaster, β-form: β-hemihydrate, stucco plaster, β-plaster, plaster of Paris | soluble anhydrite   | raw anhydrite, natural anhydrite, synthetic anhydrite, chemical anhydrite, by-product anhydrite, calcined anhydrite | high-temperature anhydrite |
| Synthesis conditions: temperature, °C, and atmosphere | < 40  | α-form: > 45, from aqueous solution; β-form: 45–200, in dry air  | α- and β-AIII: 50 and vacuum or 100 in air; β-AIII': 100 in dry air | 200–1180  | > 1180                     |
| Production temperature, °C                            | < 40  | α-form: 80–180; β-form: 120–180  | β-AIII and β-AIII': 290; α-AIII: 110                                | 300–900, specifically AII-s: < 500; AII-u: 500–700; AII-E: > 700  | not produced commercially  |

<sup>a</sup>Metastable in air saturated with water vapor.

<sup>b</sup>Metastable in dry air.

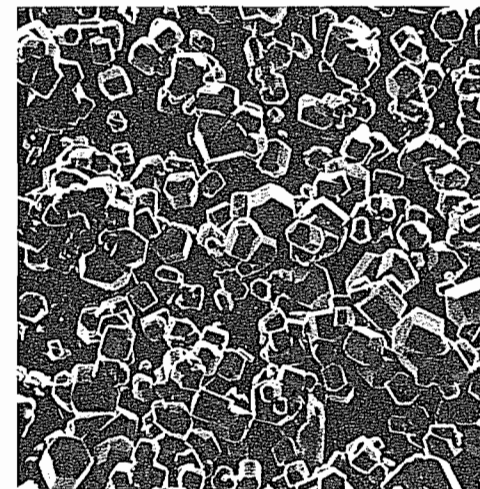

Figure 56.14: α-Hemihydrate (scanning electron micrograph), 200 ×.

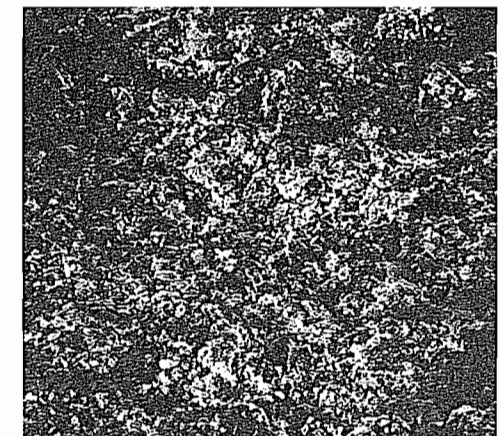

Figure 56.15: β-Hemihydrate (scanning electron micrograph), 200 ×.

Table 56.12: Physical properties of the  $\text{CaSO}_4 \cdot x\text{H}_2\text{O}$ .

| Property  | Calcium sulfate dihydrate                          | Calcium sulfate hemihydrate |                        | Anhydrite III                                   | Anhydrite II                                    | Anhydrite I  |
|---|--|-----------------------------|------------------------|---|---|--------------|
|   |  | $\alpha$ -form              | $\beta$ -form          |   |   |              |
| Water of crystallization, %                           | 20.92  | 6.21                        | 6.21                   | 0.00  | 0.00  | 0.00         |
| Density, $\text{g/cm}^3$                              | 2.31   | 2.757                       | 2.619–2.637            | 2.580   | 2.93–2.97                                       | undetermined |
| Mohs hardness   | 1.5  | —                           | —                      | —   | 3–4   | —            |
| Solubility in water at 20 °C, g per 100 g of solution | 0.21   | 0.67                        | 0.88                   | hydrates to the hemihydrate                     | (0.27)  | —            |
| Refractive indices $n_\alpha$                         | 1.521  | 1.559 <sup>a</sup>          | 1.559 <sup>a</sup>     | 1.501   | 1.570   | undetermined |
| $n_\beta$   | 1.523  | 1.5595 <sup>a</sup>         | 1.5595 <sup>a</sup>    | 1.501   | 1.576   | undetermined |
| $n_\gamma$  | 1.530  | 1.584                       | 1.584                  | 1.546   | 1.614   | undetermined |
| Optical character                                     | +  | —                           | —                      | +   | +   | undetermined |
| Optical orientation                                   | $n_\beta \parallel b$<br>$n_{\gamma c} = 52^\circ$ | $c \parallel n_\gamma$      | $c \parallel n_\gamma$ | $n_\alpha \parallel c$<br>$n_\beta \parallel c$ | $n_\alpha \parallel c$<br>$n_\beta \parallel c$ | undetermined |
| Axial angle $2V'$                                     | $58-60^\circ$                                      | $14^\circ$                  | $14^\circ$             | $\approx 0^\circ$                               | $42-44^\circ$                                   | undetermined |
| Lattice symmetry                                      | monoclinic   | monoclinic                  | monoclinic             | orthorhombic                                    | orthorhombic                                    | cubic        |
| Space group   | I 2/a  | I 121                       | I 121                  | C 222   | Amma  | undetermined |
| Lattice spacing, nm, $a$                              | 0.5679   | 1.20317                     | 1.20317                | 1.20777   | 0.7006  | undetermined |
| $b$   | 1.5202   | 0.69269                     | 0.69269                | 0.69723   | 0.6998  | undetermined |
| $c$   | 0.6522   | 1.26712                     | 1.26712                | 0.63040   | 0.6245  | undetermined |
| $\beta$   | $118.43^\circ$                                     | $90.27^\circ$               | $90.27^\circ$          | —   | —   | undetermined |

<sup>a</sup> Average.

### 56.6.1.2 Laboratory Synthesis

The thermodynamic stability ranges for the calcium sulfate phases are shown in Table 56.11. Below 40 °C, i.e., under normal atmospheric conditions, only calcium sulfate dihydrate is stable. The other phases are obtained at higher temperatures by progressive dehydration of the calcium dihydrate in the following order:

dihydrate → hemihydrate → anhydrite III → anhydrite II

Under normal atmospheric conditions hemihydrate and anhydrite III are metastable, and below 40 °C in the presence of water or water vapor they undergo conversion to the dihydrate, as anhydrite II does. However, between 40 °C and 1180 °C anhydrite II is stable.

To synthesize pure phases in the laboratory,  $\beta$ -hemihydrate is made from the dihydrate by heating at a low water-vapor partial pressure, i.e., in dry air or vacuum, between 45 °C and 200 °C. Further careful heating at 50 °C in a vacuum or up to  $\approx 200$  °C at atmospheric pressure produces  $\beta$ -anhydrite III.

At very low water-vapor partial pressure, if water vapor is released rapidly and particle size is small  $\beta$ -anhydrite III' forms directly from the dihydrate, without formation of an intermediate hemihydrate. The specific surface area of such  $\beta$ -anhydrite III' can be up to ten times that of  $\beta$ -anhydrite III.

$\alpha$ -Hemihydrate is obtained from the dihydrate at high water-vapor partial pressure, e.g., above 45 °C in acid or salt solutions, or above 97.2 °C in water under pressure (e.g., 134 °C, 3 bar). Further careful release of water at 50 °C in a vacuum or at 100 °C under atmospheric pressure yields  $\alpha$ -anhydrite III.

Anhydrite III is difficult to prepare pure because anhydrite II begins to form above 100 °C, and anhydrite III reacts readily with water vapor to form hemihydrate.

The  $\beta$ -hemihydrates from  $\beta$ -anhydrite III and  $\beta$ -anhydrite III' differ in their physical properties [77]. Therefore hemihydrates from  $\beta$ -anhydrite III' should be designated as  $\beta$ -hemihydrate'.  $\alpha$ -Anhydrite III absorbs water vapor to form  $\alpha$ -hemihydrate. Likewise, the hemihydrates, in humid air, reversibly adsorb

up to 2% of their weight in water without converting to dihydrate. This nonstoichiometric water in the hemihydrate can be completely removed by drying at 40 °C.

Gypsum dehydration kinetics have been investigated by several authors.

Neutron and x-ray powder diffraction studies have shown that the dehydration (and hydration) mechanism is strongly topotactic in the temperature range of 20–350 °C [78, 79].

In neutron thermodiffraction experiments it was found that gypsum decomposes to  $\text{CaSO}_4(\text{H}_2\text{O})_{0.5}$ , then to anhydrite III, and finally to anhydrite II. With high local steam pressure, a subhydrate with 0.74  $\text{H}_2\text{O}$  was found [79].

According to another paper three phases of the  $\alpha$ -hemihydrate type can be prepared as pure samples:  $\text{CaSO}_4(\text{H}_2\text{O})_{0.6}$ ,  $\text{CaSO}_4(\text{H}_2\text{O})_{0.5}$ , and anhydrite III. The crystal structures of these phases were determined; data for  $\text{CaSO}_4(\text{H}_2\text{O})_{0.5}$  and for anhydrite III are listed in Table 56.12. The structure of the subhydrate  $\text{CaSO}_4(\text{H}_2\text{O})_{0.6}$  was found to be monoclinic, space group I 121, with  $a = 1.19845$ ,  $b = 0.69292$ ,  $c = 1.27505$  nm and  $\beta = 90^\circ$ . The density is 2.74  $\text{g/cm}^3$  [80].

In general the hemihydrate  $\text{CaSO}_4(\text{H}_2\text{O})_{0.5}$  is considered to be the kinetically most stable subhydrate. Table 56.12 also lists the well-established crystallographic data of gypsum [81] and of anhydrite II [82, 83].

Anhydrite II is formed at temperatures between 200 °C and 1180 °C. Above 1180 °C, anhydrite I forms; below 1180 °C it reverts to anhydrite II.

Another mechanism for conversion of gypsum directly to anhydrite II has been found in the catalytic action of small quantities of sulfuric acid on moist, finely divided gypsum at 100–200 °C. In this case anhydrite II with orthorhombic crystal structure is produced by neof ormation [84].

### 56.6.1.3 Industrial Dehydration of Gypsum

Industrially it is most important that dehydration is achieved in the shortest time with the lowest energy consumption, i.e., that the costs be held to a minimum. Because of kinetic inhibitions calcination is carried out at much higher temperatures than those used in the laboratory (Table 56.11). Rarely are pure phases produced during manufacture; rather, mixtures of phases of the  $\text{CaSO}_4\text{-H}_2\text{O}$  system are produced. Three types of calcined anhydrite II (anhydrous gypsum plaster or overburnt plaster) are manufactured, depending on burn temperature and time:

- Anhydrite II-s (slowly soluble anhydrite), produced between 300 and 500 °C
- Anhydrite II-u (insoluble anhydrite), produced between 500 and 700 °C
- Anhydrite II-E (partially dissociated anhydrite; floor plaster, *Estrichgips*), produced above  $\approx 700$  °C

In use the difference among these products lies in the rates of rehydration with water, which for anhydrite III-s is fast, for anhydrite II-u slow, and for anhydrite II-E in between, a little faster than anhydrite II-u (Figure 56.23). Transitions between these different stages of reaction are possible.

Anhydrite II-E consists of a solid mixture of anhydrite II and calcium oxide formed by the partial dissociation of anhydrite into sulfur trioxide and calcium oxide when raw gypsum is heated above 700 °C. The presence of impurities lowers the normal dissociation temperature of anhydrite II,  $\approx 1450$  °C.

### 56.6.1.4 Energy Aspects

KELLY et al. made a thorough study of the thermodynamic properties of the  $\text{CaSO}_4\text{-H}_2\text{O}$  system [85, 86]. Tables 56.13 and 56.14 list the heats of hydration and dehydration of the various phase changes that are of industrial significance.

Table 56.13: Heats of hydration.

| Phase change   | Heats of hydration per mole (gram) of dihydrate at 25 °C, J |
|--|---|
| $\beta\text{-CaSO}_4 \cdot \frac{1}{2}\text{H}_2\text{O} + \frac{3}{2}\text{H}_2\text{O}_{(l)} \rightarrow \text{CaSO}_4 \cdot 2\text{H}_2\text{O}$  | 19 300 ± 85 (111.9 ± 0.50)                                  |
| $\alpha\text{-CaSO}_4 \cdot \frac{1}{2}\text{H}_2\text{O} + \frac{3}{2}\text{H}_2\text{O}_{(m)} \rightarrow \text{CaSO}_4 \cdot 2\text{H}_2\text{O}$ | 17 200 ± 85 (100.00 ± 0.50)                                 |
| $\beta\text{-CaSO}_{4(m)} + 2\text{H}_2\text{O}_{(l)} \rightarrow \text{CaSO}_4 \cdot 2\text{H}_2\text{O}$   | 30 200 ± 85 (175.3 ± 0.50)                                  |
| $\alpha\text{-CaSO}_{4(m)} + 2\text{H}_2\text{O}_{(l)} \rightarrow \text{CaSO}_4 \cdot 2\text{H}_2\text{O}$  | 25 700 ± 85 (149.6 ± 0.50)                                  |
| $\text{CaSO}_{4(m)} + 2\text{H}_2\text{O}_{(l)} \rightarrow \text{CaSO}_4 \cdot 2\text{H}_2\text{O}$   | 16 900 ± 85 (98.0 ± 0.50)                                   |

Table 56.14: Heats of dehydration.

| Phase change   | Heat of dehydration per mole or tonne of dehydration products at 25 °C |         |
|--|--|---------|
|  | J/mol  | kJ/t    |
| $\text{CaSO}_4 \cdot 2\text{H}_2\text{O} \rightarrow \beta\text{-CaSO}_4 \cdot \frac{1}{2}\text{H}_2\text{O} + \frac{3}{2}\text{H}_2\text{O}_{(g)}$  | 86 700   | 597 200 |
| $\text{CaSO}_4 \cdot 2\text{H}_2\text{O} \rightarrow \alpha\text{-CaSO}_4 \cdot \frac{1}{2}\text{H}_2\text{O} + \frac{3}{2}\text{H}_2\text{O}_{(g)}$ | 84 600   | 582 700 |
| $\text{CaSO}_4 \cdot 2\text{H}_2\text{O} \rightarrow \beta\text{-CaSO}_{4(m)} + 2\text{H}_2\text{O}_{(g)}$   | 121 800  | 895 700 |
| $\text{CaSO}_4 \cdot 2\text{H}_2\text{O} \rightarrow \alpha\text{-CaSO}_{4(m)} + 2\text{H}_2\text{O}_{(g)}$  | 117 400  | 863 100 |
| $\text{CaSO}_4 \cdot 2\text{H}_2\text{O} \rightarrow \text{CaSO}_{4(m)} + 2\text{H}_2\text{O}_{(g)}$   | 108 600  | 798 000 |

### 56.6.1.5 Structure, Mixed Compounds, Solubility

**Crystal Structure.** All structures in the  $\text{CaSO}_4\text{-H}_2\text{O}$  system consist of chains of alternate  $\text{Ca}^{2+}$  and  $\text{SO}_4^{2-}$  ions. These  $\text{CaSO}_4$  chains remain intact during phase changes.

Calcium sulfate dihydrate has a layered structure, and the water of crystallization is embedded in between the layers.

When calcium sulfate dihydrate is dehydrated to hemihydrate, a tunnel structure is formed with wide channels parallel to the  $\text{CaSO}_4$  chains. In the subhydrates the tunnels are filled with water molecules; in anhydrite III they are empty.

The relative ease of escape of these water molecules explains the facile conversion from subhydrate to anhydrite III.

Anhydrite II exhibits closest packing of ions, which makes it the densest and strongest of the calcium sulfates. However, lacking empty channels, it reacts only very slowly with water.

The  $\alpha$ - and  $\beta$ -forms of calcium sulfate hemihydrate exhibit no crystallographic differences. The  $\beta$ -forms of calcium sulfate hemihydrate are active states of the  $\alpha$ -form [87].

**Isomorphism.** Isomorphous incorporation of chemical compounds into the lattice of  $\text{CaSO}_4\text{-H}_2\text{O}$  phases is of interest in connec-

tion with gypsums from flue-gas desulfurization and wet phosphoric acid processes. Isomorphous incorporation of calcium hydrogenphosphate dihydrate occurs because the  $\text{CaHPO}_4 \cdot 2\text{H}_2\text{O}$  has lattice spacings almost identical with those of  $\text{CaSO}_4 \cdot 2\text{H}_2\text{O}$  [88]. Monosodium phosphate,  $\text{NaH}_2\text{PO}_4$ , can also be incorporated into the gypsum lattice [89]. KITCHEN et al. [90] consider isomorphism between the ions  $\text{AlF}_5^{2-}$  and  $\text{SO}_4^{2-}$  a possibility. EIPeltauer [74, 91] reports on further isomorphism, incorporation of the anion  $\text{FPO}_3^{2-}$  as well as the incorporation of  $\text{Na}^+$ ,  $\leq 0.2\%$  in the hemihydrate lattice, but only 0.02% in the dihydrate lattice. Chlorides are not incorporated.

**Double and Triple Salts.** Gypsum forms double salts with alkali-metal or ammonium sulfate, some of which occur in nature, such as syngenite,  $\text{CaSO}_4 \cdot \text{K}_2\text{SO}_4 \cdot \text{H}_2\text{O}$ .

There are triple sulfates of calcium with the divalent ions of the iron and zinc subgroups and of manganese, copper, and magnesium along with the univalent alkali metals, also including ammonium. A good example is the well known polyhalite,  $2\text{CaSO}_4 \cdot \text{MgSO}_4 \cdot \text{K}_2\text{SO}_4 \cdot 2\text{H}_2\text{O}$ , which also occurs in natural salt deposits.

Ettringite,  $3\text{CaO} \cdot \text{Al}_2\text{O}_3 \cdot 3\text{CaSO}_4 \cdot 32\text{H}_2\text{O}$ , is important in cement chemistry [92], as are syngenite [93] and thaumasite [94].

**Adducts.** Gypsum forms sulfuric acid adducts in concentrated sulfuric acid:  $\text{CaSO}_4 \cdot 3\text{H}_2\text{SO}_4$  and  $\text{CaSO}_4 \cdot \text{H}_2\text{SO}_4$  [95].

Calcium sulfate dihydrate can combine with four molecules of urea to form an addition compound.

**Solubility and Supersaturation.** Gypsum is slightly soluble in water (Table 56.12). The solubilities of the various forms of calcium sulfate are strongly affected by the presence of other solutes. The references [58, 61] can be consulted for particulars on the solubility of gypsum in acids, especially sulfuric acid, phosphoric acid, and nitric acid. Gypsum is readily soluble in glycerol and sugar solutions and in aqueous solutions of chelating agents, such as EDTA. All calcium sulfates have a tendency to supersaturation [58].

## 56.6.2 Occurrence, Raw Materials

### 56.6.2.1 Gypsum and Anhydrite Rock

Gypsum and anhydrite deposits are found in many countries. They originated from supersaturated aqueous solutions in shallow seas, which evaporated and deposited first carbonates, then sulfates, and finally chlorides, i.e., in order of increasing solubility [59, 60].

Gypsum and anhydrite are almost always found in the Permian, Triassic, and Tertiary formations. The Permian includes the Upper Permian (Zechstein deposits, Germany). The Triassic consists of Lower (*Buntsandstein*), Middle (*Muschelkalk*), and Upper Triassic (*Keuper*). The Tertiary deposits include the Eocene (Spain, Persia, Near East), the Oligocene (Paris), and the Miocene deposits (Mediterranean area, North Africa). The Jurassic and Cretaceous formations, which lie between the Triassic and Tertiary, are almost devoid of useful gypsum deposits, as are the older pre-Permian formations — at least in the Old World — as, for example, the Carboniferous formation.

The currently accepted view is that gypsum,  $\text{CaSO}_4 \cdot 2\text{H}_2\text{O}$ , was formed upon initial crystallization. The best known deposits of primary gypsum are those of the Paris Basin and the areas around the Mediterranean. Under increased pressure and thus temperature, anhydrite could have developed locally from the original gypsum [96, 97]. However, uptake of surface water can convert the anhydrite back into gypsum. This gypsum is therefore a secondary rock, especially in formations older than the Middle Tertiary [98].

The various gypsum and anhydrite deposits differ in purity, structure, and color. The major impurities are calcium carbonate (limestone), dolomite, marl, clay; less frequently, silica, bitumen, glauberite, syngenite, and polyhalite. If these are present in the gypsum and anhydrite from its formation, they are called *primary impurities*. A distinction is drawn between carbonate-sulfate deposits, mainly found in the Upper Permian (Zechstein), and the clay-sulfate deposits, which predominate in the Triassic [99]. *Secondary impurities* are formed during exposure to materials flushed into cracks and leached cavities, but may also be introduced into the rock as waste material during mining. Gypsum is readily soluble in water, even if it is only slightly soluble, and therefore gypsum rock is leached by surface water. The chemical composition of some calcium sulfates is shown in Table 56.15.

Workable gypsum and anhydrite rock are structurally quite distinct from one another. The most important types of native gypsum are sparry gypsum, also called gypsum spar or flaky gypsum (selenite), fibrous gypsum, alabaster (grainy gypsum), gypsum rock (common gypsum, also massive gypsum), porphyritic gypsum, earthy gypsum (gypsite in the United States), and gypsum sand (contaminated with Glauber's salt  $\text{Na}_2\text{SO}_4 \cdot 10\text{H}_2\text{O}$ ). Anhydrite, always crystalline, can either be sparry (anhydrite spar), coarse to close grained, or even rod shaped.

**Table 56.15:** Chemical composition of some calcium sulfates.

|   | Natural gypsums |        | Natural anhydrites |        | Phosphogypsums |      |      | Fluoroanhydrite                   |
|---|-----------------|--------|--------------------|--------|----------------|------|------|-----------------------------------|
|   | Zechstein       | Keuper | Zechstein          | Keuper | a              | b    | c    | d                                 |
| <b>Mineralogical analysis</b>                                   |                 |        |                    |        |                |      |      |                                   |
| CaSO <sub>4</sub> ·2H <sub>2</sub> O                            | 91.6            | 96.4   | 6.0                | 3.8    | 93.0           | 97.6 | 96.5 | 0.0                               |
| CaSO <sub>4</sub> II  | 6.4             | 0.9    | 88.8               | 83.7   | 0.0            | 0.0  | 0.0  | 94.7                              |
| MgCO <sub>3</sub>   | 0.1             | 0.6    | 2.0                | 3.6    | 0.0            | 0.0  | 0.0  | 0.0                               |
| CaCO <sub>3</sub>   | 1.9             | 1.3    | 3.1                | 5.3    | 0.0            | 0.0  | 0.0  | 0.0                               |
| <b>Chemical analysis</b>  |                 |        |                    |        |                |      |      |                                   |
| Combined water  | 19.1            | 20.1   | 1.3                | 0.8    | 19.5           | 19.2 | 19.2 | 0.0                               |
| SO <sub>3</sub>   | 46.4            | 45.4   | 55.1               | 51.0   | 43.2           | 45.4 | 46.9 | 56.4                              |
| CaO   | 33.6            | 32.5   | 40.3               | 38.7   | 32.2           | 32.5 | 32.1 | 40.8                              |
| MgO   | 0.05            | 0.28   | 0.95               | 1.71   | 0.01           | 0.01 | 0.01 | 0.13                              |
| SrO   | 0.07            | 0.16   | 0.07               | 0.14   | 0.06           | 2.05 | 0.05 | 0.0                               |
| Fe <sub>2</sub> O <sub>3</sub> + Al <sub>2</sub> O <sub>3</sub> | 0.01            | 0.08   | 0.01               | 0.39   | 0.27           | 0.70 | 0.93 | 0.27                              |
| HCl-insoluble residue   | 0.10            | 0.47   | 0.10               | 2.49   | 1.51           | 1.00 | 0.68 | 0.69                              |
| Na <sub>2</sub> O   | 0.02            | 0.01   | 0.04               | 0.11   | 0.47           | 0.14 | 0.02 | 0.03                              |
| Total P <sub>2</sub> O <sub>5</sub>                             | 0.0             | 0.0    | 0.0                | 0.0    | 1.01           | 0.11 | 0.30 | 0.0                               |
| F   | 0.0             | 0.0    | 0.0                | 0.0    | 1.76           | 0.14 | 0.29 | 0.92                              |
| Others  |                 |        |                    |        |                |      |      | 0.11 ZnO<br>0.69 K <sub>2</sub> O |
| Organics  | 0.0             | 0.0    | 0.0                | 0.0    | 0.08           | 0.03 | 0.04 | 0.0                               |
| Ignition loss   | 0.54            | 0.71   | 2.08               | 4.45   | 1.38           | 0.34 | 0.43 | 0.14                              |
| pH  | 6-7             | 6-7    | 6-7                | 6-7    | 3              | 9    | 4    | 10-12                             |

<sup>a</sup>From Moroccan raw phosphate, dihydrate process.

<sup>b</sup>From Kola raw phosphate, dihydrate/hemihydrate process, after rehydration to dihydrate.

<sup>c</sup>From Moroccan raw phosphate, hemihydrate/dihydrate process.

<sup>d</sup>From hydrofluoric acid production, Zechstein is an Upper Permian deposit; Keuper, an Upper Triassic.

Gypsum can be pure white. If it contains iron oxide, it is reddish to yellowish. If clay and/or bitumen is present, it is gray to black. Very pure anhydrite is bluish white, but usually it is gray with a bluish tinge. The white veins sometimes found on the boundary between gypsum and anhydrite consist largely of glauberite (CaSO<sub>4</sub>·Na<sub>2</sub>SO<sub>4</sub>) or Glauber's salt (Na<sub>2</sub>SO<sub>4</sub>·10H<sub>2</sub>O).

### 56.6.2.2 Flue-Gas Desulfurization (FGD) Gypsum

FGD gypsum is produced from the desulfurization of combustion gases of fossil fuels (coal, lignite, oil) in power stations as a product with a specification and quality standards. The internationally accepted definition of FGD gypsum is: "Gypsum from flue gas desulfurization plants (FGD gypsum, desulfogypsum) is moist, finely divided, crystalline, high-purity calcium sulfate dihydrate, CaSO<sub>4</sub>·2H<sub>2</sub>O. It is specifically produced in a flue gas desulfurization process incorporating after lime(stone) scrubbing, a refining process in-

volving oxidation followed by gypsum separation, washing, and dewatering." [100]

FGD gypsum is produced in four stages:

- **Desulfurization:** In a first circuit the dedusted flue gas is sprayed with a limestone suspension in counterflow. The reaction, which takes place at pH 7-8, produces insoluble calcium sulfite:

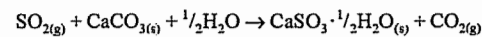

- **Forced oxidation:** In a second circuit the calcium sulfate reacts spontaneously with atmospheric oxygen at pH 5, initially forming soluble calcium bisulfite, which is then oxidized to calcium sulfate dihydrate:

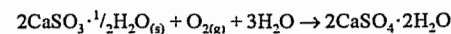

During this procedure the gypsum crystals grow by continuous circulation to the required average size of 30-70 μm.

- **Gypsum separation:** In a hydrocyclone, the calcium sulfate dihydrate crystals produced in the quencher slurry are separated and solid impurities are removed.

- **Gypsum washing and dewatering:** The calcium sulfate crystals are separated from the process water in filters or centrifuges and washed with clean wash water to remove unwanted water-soluble chlorides and sodium and magnesium salts. The resulting

FGD gypsum contains < 10% free moisture by weight. About 5.4 t of gypsum is produced per tonne of sulfur in the fuel.

Figure 56.16 shows a typical flow diagram of a flue gas desulfurization plant for producing FGD gypsum.

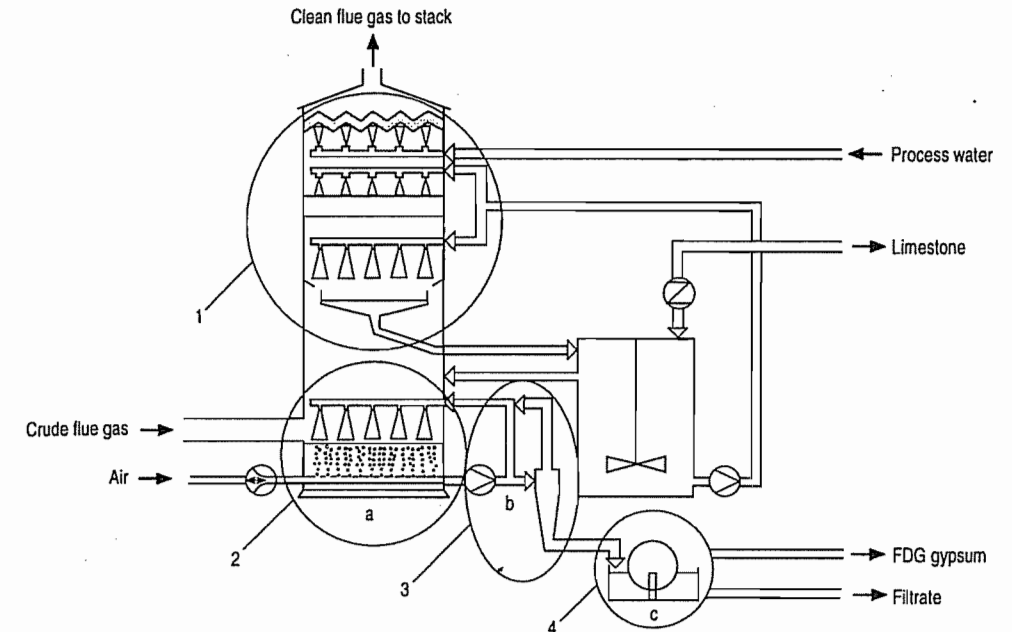

**Figure 56.16:** Flowsheet of a flue gas desulfurization plant for producing FGD gypsum with the four operation stages 1 to 4 (see text for explanation): a) Quencher; b) Hydrocyclone; c) Filter.

Sometimes FGD gypsum from lignite-fired power stations is darker than that from coal-fired power stations. Therefore a special "overflow cleaning" operation was developed to improve the color of lignite FGD gypsum. Such lignite FGD gypsum meets international quality specifications and can be used for all applications. This could be important, for example in Germany, where lignite FGD gypsum will predominate in the future [101].

A large-scale investigation has been carried out to compare FGD gypsum to natural gypsum in the production, processing, utilization, and disposal of building materials. The conclusion was that the differences in chemical composition and in trace element content between FGD gypsum and natural gypsum are insignificant. FGD gypsum can be used for the production of all building materials [102].

Table 56.16 lists quality standards for FGD gypsum.

**Table 56.16:** Quality standards for FGD gypsum.

| Quality parameters             | Quality standards    |
|--------------------------------|----------------------|
| Free moisture                  | < 10.0%              |
| Calcium sulfate dihydrate      | > 95.0% <sup>a</sup> |
| Magnesium oxide, water soluble | < 0.10%              |
| Sodium oxide, water soluble    | < 0.06%              |
| Chloride                       | < 0.01%              |
| Sulfur dioxide                 | < 0.25%              |
| pH                             | 5-9                  |
| Color                          | white <sup>b</sup>   |
| Odor                           | neutral              |
| Toxicity                       | nontoxic             |

<sup>a</sup>The reduction of the calcium sulfate dihydrate content by inert elements is not detrimental to the different areas of application.

<sup>b</sup>Different color values may apply depending on the use of the FGD gypsum and the final products.

FGD gypsum is not regarded as a waste and is therefore not included in the European Waste Catalogue (EWC).

FGD gypsum is used directly in the gypsum industry (and small quantities in the cement industry) without any further treatment, and is equivalent to natural gypsum.

The predicted quantities of FGD gypsum from coal-fired and lignite-fired power stations in Europe, the United States and Canada, and Japan and Taiwan in 1996 are listed in Table 56.17 [101].

Table 56.17: Predicted quantities of FGD gypsum in 1996.

| Country          | Quantity of FGD gypsum, 10 <sup>3</sup> t |
|------------------|---|
| Germany          | 4920                                      |
| Denmark          | 340                                       |
| Finland          | 190                                       |
| Great Britain    | 1200                                      |
| Italy            | 40  |
| Netherlands      | 360                                       |
| Austria          | 100                                       |
| Poland           | 770                                       |
| Russia           | 60  |
| Czech Republic   | 40  |
| Ukraine          | 85  |
| Total for Europe | 8225                                      |
| USA and Canada   | 3000                                      |
| Japan and Taiwan | 2300                                      |

In Germany the quantities of FGD gypsum will rise from  $4.9 \times 10^6$  t in 1996 to  $6.3 \times 10^6$  t in the year 2000 due to lignite FGD gypsum from new power stations in the former Democratic Republic.

In Spain, France, Italy and Turkey, fairly large quantities are to be expected after 1996.

The quantities of FGD gypsum produced in Japan and Taiwan of ca.  $2.3 \times 10^6$  t are expected to remain stable after 1996 [137].

The quantities of FGD gypsum predicted for the United States and Canada will probably be attained later than predicted above, i.e., only after 1996.

### 56.6.2.3 Phosphogypsum

By far the largest amount of by-product gypsum is obtained from the production of wet phosphoric acid from phosphate rock

(usually fluorapatite) and sulfuric acid ( $n \times M_r$ ):

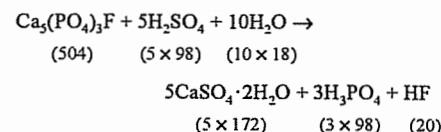

Worldwide, about 100 Mt/a of phosphogypsum are currently obtained. Phosphogypsum is a waste and therefore listed in the EWC as follows [105]:

06 00 00: Wastes from inorganic chemical processes

06 09 01: Phosphogypsum

In the OECD lists on the Control of Transfrontier Movements of Wastes, phosphogypsum is listed as follows [106]:

Amber list AB 140: Gypsum arising from chemical industry processes

This phosphogypsum is a moist, fine powder with a free water content of  $\approx 20$ –30% and considerable amounts of impurities, the exact impurities and their amounts depending on the rock and the specific process. The radioactive substances present in small amounts in phosphate rock are partly transferred to the phosphogypsum as  $^{226}\text{Ra}$ , leading to slightly increased radioactivity of such gypsums [68]. About 1.7 t of gypsum are produced per tonne of raw phosphate, corresponding to 5 t of gypsum per tonne of phosphorus pentoxide produced.

Currently  $< 4\%$  of the phosphogypsum obtained is utilized. The principal difference in using phosphogypsum compared to FGD gypsum is the need to refine phosphogypsum by washing, flotation, and recrystallization to remove harmful impurities and to modify its unsuitable particle shape. However, today it is simply cheaper to use natural gypsum or FGD gypsum than to purify and process phosphogypsum. The quantity of phosphogypsum obtained annually is nearly equal to world demand for natural gypsum and anhydrite of ca.  $100 \times 10^6$  t/a.

### 56.6.2.4 Fluoroanhydrite

Anhydrite is a by-product in the production of hydrofluoric acid from fluorspar and sulfu-

ric acid, to the extent of 2–3 Mt per year ( $n \times M_r$ ):

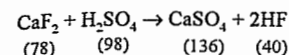

One tonne of fluorspar produces 1.75 t of anhydrite. Fluoroanhydrite is used as a raw material for the gypsum industry only in Germany and some of its neighbors.

### 56.6.2.5 Other By-product Gypsums

Calcium sulfate dihydrate is obtained as a waste in small quantities in the production or treatment of organic acids (e.g., tartaric acid, citric acid, and oxalic acid) or inorganic acids (e.g., boric acid). All these acids are produced by reaction of their calcium salt with sulfuric acid.

The amounts of industrial by-product gypsums are expected to increase from treating sulfate-containing waste waters and neutralizing dilute sulfuric acids that are produced in the processing of minerals (e.g., zinc ore) and the manufacture of pigments (e.g., titanium dioxide). Especially titanogypsum is obtained in large quantities and can be used in the gypsum industry if it is produced in the titanium dioxide industry with specification and quality standards similar to FGD gypsum. Several 100 000 tonnes are already used in the gypsum industries of Japan, the United States and Europe [137].

Gypsum scrap from the ceramic industry and metal foundries has likewise not been used so far as a raw material for the gypsum industry, although efforts continue to be made in that direction [107]. The quantities are small and recovery operations are very costly because of the impurities originating from slip casting.

### 56.6.3 Production

Although a dozen industrial processes for the preparation of cementitious calcium sulfates are well known, only a few are used extensively in the industrial countries. The

processes characterized by low capital and operating costs, simple design and operation, robust and long-lasting equipment, and uniform high-grade calcined gypsum product subsequently used to manufacture gypsum building components and gypsum plaster are discussed in the following chapter.

Since the two major raw materials — natural gypsum and FGD gypsum — are processed differently, they are discussed separately, as is the processing of phosphogypsum.

### 56.6.3.1 Natural Gypsum to Calcined Products

Natural gypsum is mined by the open-pit method [108] and by underground mining [109]. In open-pit mining the gypsum is recovered by drilling and blasting, mostly on one or more levels. In deep mining, chamber blasting is used [110]. The blasted rock consists of large lumps, containing 0–3% free moisture (quarry water). The amounts of explosives needed are about 250 g/t for open-cast mining and 400 g/t for underground mining.

The coarse rock is conveyed to the crushing plants, normally at the gypsum works, by means of trackless loading and haulage gear. Impact crushers, jaw crushers, and single-roll crushers with screen and oversize return are all suitable for coarse size reduction. Impact pulverizers or roller mills are used for intermediate size reduction; and hammer mills, ball mills, or ring-roll mills are used for fine grinding. The degree of size reduction is determined by the calcining unit or the intended use of the gypsum:

|   |          |
|---|----------|
| Rotary kiln                                   | 0–25 mm  |
| Kettle  | 0–2 mm   |
| Kettle with combined drying and grinding unit | 0–0.2 mm |
| Conveyor kiln                                 | 4–60 mm  |
| Gypsum and anhydrite for cement               | 5–50 mm  |

If transport by ship or truck to distant gypsum or cement plants is necessary, the material is reduced to required size for further treatment prior to transport.

Cleaning or beneficiating the blasted rock is no longer common practice, except for gypsum with much Glauber's salt, which is

readily removed by leaching with water. This is still done in Britain [108].

Often the mined and crushed rock is homogenized before being calcined. This is done in homogenizing plants with capacities of about one week's production.

The final stage in gypsum open-pit mining is the restoration of the quarry site and its re-inclusion in the environment of the area.

**$\beta$ -Hemihydrate Plasters.** Stucco and plaster of Paris are prepared by dry calcination between 120 °C and 180 °C, either in directly fired rotary kilns or else in indirectly heated kettles, to produce the  $\beta$ -hemihydrate. The kettles may be upright or horizontal.

The *rotary kiln* (capacities up to 600 t/d) is particularly suitable for calcining granular (0–25 mm) gypsum rock. This, without predrying, is fed continuously to the kiln in cocurrent flow with the hot gases with a weigh-belt feeder and cellular wheel sluice (Figure 56.17). The hot gases are produced in a brick-lined combustion chamber ahead of the gypsum feed. The shell of the rotary kiln is not brick-lined but consists of thick steel plates with steel inserts to ensure an even distribution of gypsum particles across the furnace cross section.

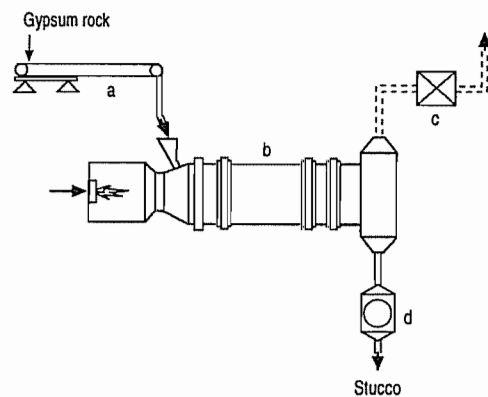

Figure 56.17: Production of stucco (plaster of Paris,  $\beta$ -hemihydrate plaster) by the rotary kiln process: a) Weigh-belt feeder; b) Rotary kiln with combustion chamber; c) Cyclone; d) Pulverizer.

High thermal efficiency is achieved by the direct transfer of heat from the hot gases to the gypsum. The residence time of the gypsum rock in the kiln is self-regulating. It increases with the size of the grains, but complete calcination can be achieved regardless of particle size, to produce  $\beta$ -hemihydrate of uniform quality and invariant properties after fine grinding and air classifying. Any gypsum not dehydrated to hemihydrate at start-up or shut-down is collected in a bin and added in small quantities to the calcined gypsum. Rotary kiln plants are fully automatic and usually can be controlled by one worker.

The externally heated *kettle*, of capacity up to 760 t/d, is the first of a series of similar calcining units heated indirectly. The gypsum is predried and ground to < 2 mm. In modern plants fine grinding, which used to follow the calcining process, is combined with the predrying and carried out in drying-grinding units to produce particles < 0.2 mm (Raymond mill, Claudius Peters mill, Attritor). The properties of the product hemihydrate are shown in Table 56.18. The phase composition of plaster of Paris is shown in Table 56.19.

In the 1960s [112, 113] the kettle process was improved and made continuous, especially in England (British Plaster Board Ltd.) and North America. Predried and finely ground gypsum is fed continuously from above. As it dehydrates, the gypsum sinks to the bottom, the water vapor set free keeping the gypsum bed fluidized. The calcined gypsum settles at the bottom of the kettle, where it is continuously discharged through a pipe connected to the side of the kettle.

Figure 56.18 shows a flow diagram for such a plant. The thermal balance is not quite as good as for directly fired rotary kilns, but the waste gases are less dust laden. Up to 760 t of hemihydrate plaster per day can be produced in this type of plant.

Table 56.18: Properties of calcined gypsum [111].

| Manufacturing process | Type of plaster       | g plaster/100 g H <sub>2</sub> O | Water-to-plaster ratio | Setting time, min |     | Strength of hardened plaster <sup>a</sup> , N/mm <sup>2</sup> |             |          | Density of hardened specimen, kg/m <sup>3</sup> |
|-----------------------|-----------------------|----------------------------------|------------------------|-------------------|-----|---|-------------|----------|---|
|                       |                       |                                  |                        | Start             | End | Flexural  | Compressive | Hardness |   |
| Rotary kiln           | $\beta$ -hemihydrate  | 137                              | 0.73                   | 13                | 28  | 4.8   | 11.2        | 19.1     | 1069  |
| Conveyor kiln         | multiphase            | 167                              | 0.60                   | 6                 | 35  | 5.1   | 15.5        | 25.9     | 1225  |
| Kettle                | $\beta$ -hemihydrate  | 156                              | 0.64                   | 9                 | 22  | 5.2   | 14.0        | 26.8     | 1133  |
| Autoclave             | $\alpha$ -hemihydrate | 263                              | 0.38                   | 10                | 22  | 12.8  | 40.4        | 92.0     | 1602  |

<sup>a</sup>40 × 40 × 160 mm specimen.

Table 56.19: Phase compositions, in %, of overburnt plaster, plaster of Paris, and multiphase plaster (impurities not considered).

|   | Plaster of Paris (rotary kiln) | Overburnt plaster (conveyor kiln) | Multiphase plaster, a mixture of plaster of Paris and overburnt plaster |
|---|--------------------------------|-----------------------------------|---|
| Dihydrate, CaSO <sub>4</sub> ·2H <sub>2</sub> O                       | 0                              | 0                                 | 0   |
| $\beta$ -Hemihydrate, $\beta$ -CaSO <sub>4</sub> ·1/2H <sub>2</sub> O | 75                             | 6                                 | 27  |
| $\beta$ -Anhydrite III, $\beta$ -CaSO <sub>4</sub> III                | 20                             | 19                                | 15  |
| Anhydrite II, CaSO <sub>4</sub> II <sup>a</sup>                       | 5                              | 75                                | 58  |

<sup>a</sup>Consisting of reaction stages, AII-s (slowly soluble A), AII-u (insoluble A), and AII-E (*Estrichgips*).

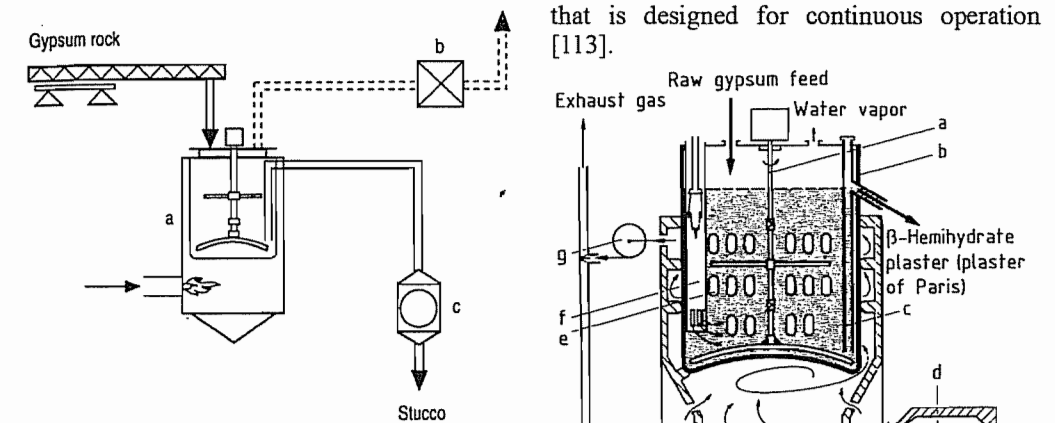

Figure 56.18: Production of stucco (plaster of Paris,  $\beta$ -hemihydrate plaster) by the continuous kettle process: a) Kettle with combustion chamber and ascending pipe; b) Cyclone; c) Pulverizer.

Recently the *submerged combustion* method — more specifically indirect heat transmission of the externally heated boiler casing combined with direct heat transmission — has been introduced. The advantages are high thermal efficiency and low energy consumption. Kettles heated only by submerged combustion are being tested at present. Existing kettles can also be fitted with submerged combustion burners, which reduces energy consumption and increases the flow rates. Figure 56.19 shows a kettle with such a burner

that is designed for continuous operation [113].

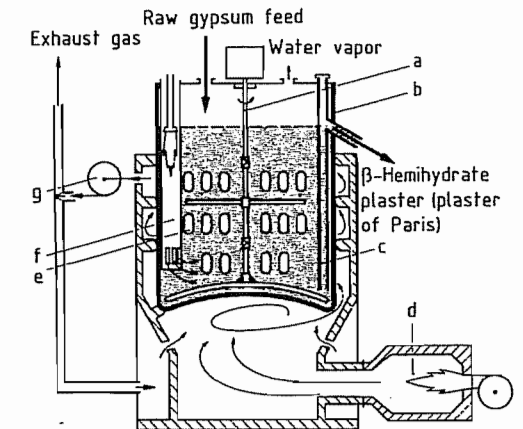

Figure 56.19: Kettle with submerged combustion burner for continuous production of  $\beta$ -hemihydrate (plaster of Paris): a) Agitator; b) Outer casing of kettle; c) Ascending pipe for stucco plaster discharge; d) Combustion chamber; e) Cross pipes for hot gases; f) Submerged pipe with submerged combustion burner; g) Ventilating fan for exhaust and circulating gas.

Batch horizontal kettles, with capacities of 5–10 t/h, are popular in France under the name of Beau.

Almost the total world production of  $\beta$ -hemihydrate is carried out in plants of the types just described. Today in North America indirectly heated kettles and directly heated



rotary kilns are in use in a proportion of about 5:1, whereas earlier only the kettle had been used. In Britain and France, the indirectly heated kettle is widely used, and in Germany, the rotary kiln and the kettle.

Most of the  $\beta$ -hemihydrate or stucco produced is used in gypsum building components; to a lesser extent  $\beta$ -hemihydrate is used in special building plaster.

Other calcining processes for the manufacture of  $\beta$ -hemihydrate have also been used industrially. In a grinding-calcining process [114], the raw gypsum is continuously crushed and calcined to  $\beta$ -hemihydrate in one single unit (Claudius Peters) (Figure 56.20). A few plants produce  $\beta$ -hemihydrate and to some extent also multiphase plaster in a fluidized bed [115–117] — the dried and finely ground gypsum rock is calcined in the stream of hot gases (Thyssen-Rheinstahl). Another development is the indirectly heated, continuously operated horizontal kettle. Externally it resembles a rotary kiln. In this unit the hot gases first pass through a central tube in cocurrent flow and then through further heating tubes in countercurrent flow. Similar is the continuously operated Holoflite calcining unit, using hot oil or superheated steam as the heat exchange medium. In this case the gypsum is moved along on a screw conveyor that has hot oil passing through it [118].

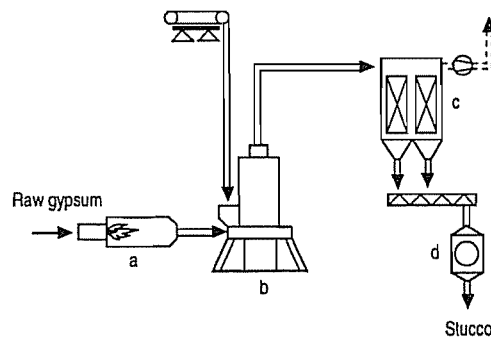

Figure 56.20: Production of stucco (plaster of Paris,  $\beta$ -hemihydrate plaster) by the grinding-calcining process: a) Combustion chamber; b) Grinding-calcining unit; c) Separating cyclone; d) Pulverizer.

### Calcined Anhydrous Plasters and Multiphase Plasters.

Overburnt plasters are produced in dry calcining processes at temperatures between 300 and 900 °C. For the most part they are calcined anhydrite. There are three reaction stages:

- AII-s, slowly soluble anhydrite, < 500 °C
- AII-u, insoluble anhydrite, 500–700 °C
- AII-E, *Estrichgips*, > 700 °C

The properties and final phase compositions of overburnt plaster are shown in Tables 56.18 and 56.19.

In overburnt plaster, and also in multiphase plaster, these three stages of reaction have to have a definite ratio, which is determined jointly by the raw material and the calcining process. In some of these processes [55] the gypsum is calcined in such a way that the anhydrite phase is obtained along with the hemihydrate. In other processes the overburnt plaster is produced separately and mixed with  $\beta$ -hemihydrate afterwards. These plasters are designated as multiphase plasters, *Putzgips* in Germany (Tables 56.18 and 56.19).

A modern calcining unit for overburnt plaster and multiphase plaster is the conveyor kiln developed by KNAUF [119] (Figure 56.21). Today, capacities up to 1200 t/d are usual, making it the most efficient kiln used for gypsum. Before being fed to the conveyor kiln, the gypsum rock is crushed to size 4–60 mm and split into three or four sieve fractions (e.g., 7–25 mm, 25–40 mm, and 40–60 mm or 4–11 mm, 11–25 mm, 25–40 mm, and 40–60 mm). The fractions are piled on the continuous conveyor grate, the smallest on the bottom. The grate, which moves continuously at a speed of 20–35 m/h, passes through a calcining hood. There the hot gases are drawn through the gypsum bed by exhaust fans. The top layer can reach a temperature up to 700 °C; the bottom layer, up to 300 °C. The temperature of the heat-resistant plates of the conveyor grate does not exceed 270 °C. The gypsum is not mixed during calcination, and therefore little dust is formed and no dust collection system is needed. About half the hot gases are discharged into the atmosphere as waste gas, issuing from the chimney at about 100 °C; the remainder (at  $\approx$  270 °C) is recirculated to the combustion

chamber together with air ( $\approx$  230 °C) drawn through the calcined gypsum bed to cool it. The thermal efficiency of such a conveyor kiln is high, greater than 70%. In Germany and elsewhere conveyor kilns with a total capacity of more than 2 Mt/a are currently in operation.

Figure 56.22 shows a flow diagram of a process producing construction plaster. In addition to a conveyor kiln it also uses a rotary kiln in which raw gypsum of small particle size (0–4 mm or 0–7 mm) is calcined to  $\beta$ -hemihydrate and subsequently mixed with anhydrous plaster that has been ground to the required fineness. In this way, multiphase plasters are produced. They differ from each other in their setting properties and also from  $\beta$ -hemihydrate plaster in that they are coarser (see Table 56.19 for composition, Table 56.18 for properties, Figure 56.23 for representation as three-component diagram) [55].

Multiphase plasters are used to finish interior walls and ceilings. Since 1965 machine-applied plaster has been produced in large quantities by incorporating chemical additives to one such multiphase plaster. Even pure construction plasters (Saarland construction plaster, southern German *Doppelbrandgips*),

which have been used in Germany for years, but which recently have declined in importance, can be prepared in these types of plants. This is also true for the construction plasters used in Latin countries, North Africa, and the Near East [120].

Other calcining plants producing anhydrous plasters operate on the principle of a countercurrent rotary kiln (Vernon). For example, in France an overburnt plaster, *surcuit*, is produced and mixed with  $\beta$ -hemihydrate to produce *Paris construction plaster* [121]. In such a countercurrent rotary kiln, the gypsum enters at the end opposite to the combustion chamber and travels into hot gases. The dehydrating gypsum reaches its maximum temperature,  $\approx$  500 °C, just before exiting the kiln. These kilns, with capacities of 15–30 t/h, are sometimes linked together and used to produce anhydrous plaster and  $\beta$ -hemihydrate simultaneously [122]. This improves the efficiency and offers the opportunity of cooling the anhydrous plaster obtained at very high temperatures advantageously. The problem of cooling has also been solved by making use of the planetary cooling system of the cement industry.

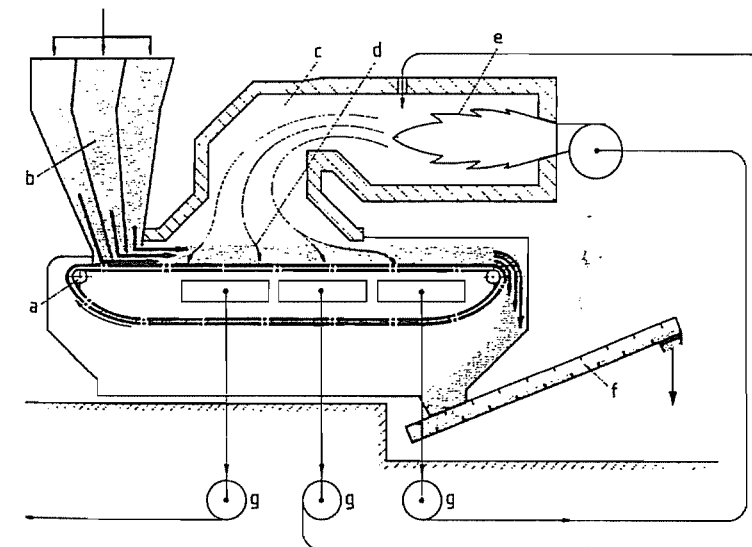

Figure 56.21: Conveyor kiln for the production of anhydrous plaster: a) Conveyor grate; b) Feed hoppers; c) Calcining hood; d) Layers of gypsum; e) Combustion chamber; f) Discharger; g) Circulating and cooling air fans for exhaust gas.

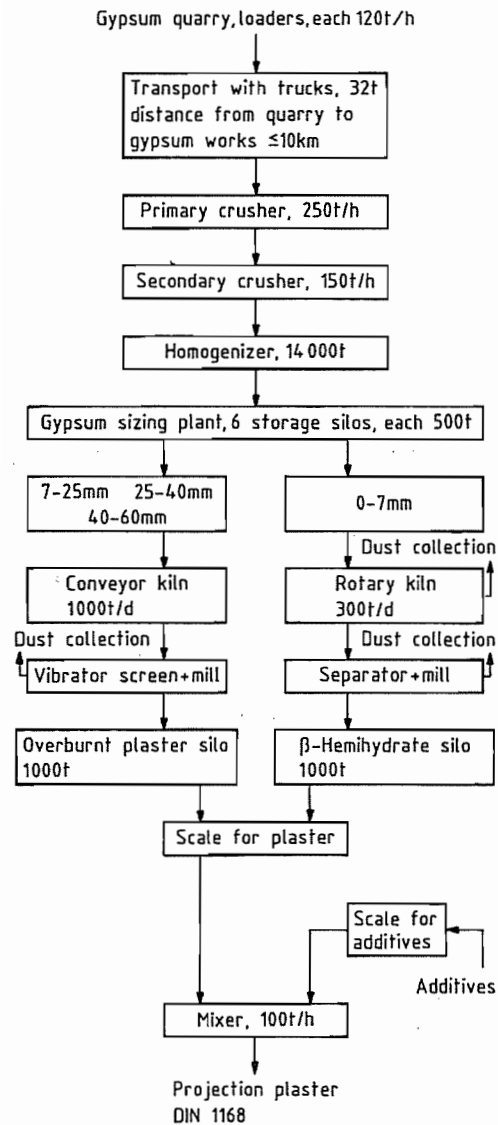

Figure 56.22: Flow diagram for production of projection plaster with a conveyor kiln.

$\alpha$ -Hemihydrate can be produced by wet calcining processes, either under elevated pressure in autoclaves or at atmospheric pressure in acids or aqueous salt solutions between  $\approx 80$  and  $150^\circ\text{C}$ . However, only the autoclave pro-

cesses have so far achieved industrial importance for the small amounts produced.

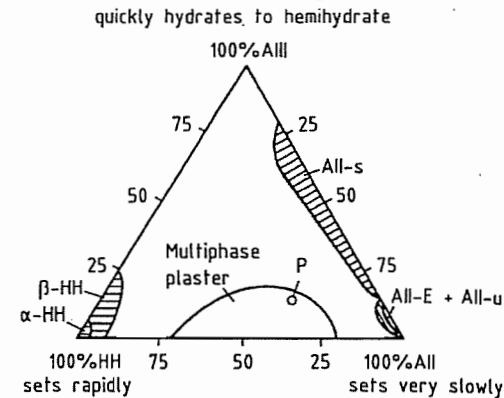

Figure 56.23: Three-phase composition diagram of calcined gypsums [55]. Point P indicates the composition of a multiphase plaster consisting of 26%  $\beta$ -hemihydrate, 14% anhydrite III, and 58% anhydrite II, the composition given in Table 56.19 for multiphase plaster.

$\alpha$ -Hemihydrate from natural gypsum is nearly always batch-processed. For instance, gypsum rock (particle size  $150\text{--}300\text{ mm}$ ,  $> 95\%$   $\text{CaSO}_4 \cdot 2\text{H}_2\text{O}$ , rocklike) is put in wire baskets, and either stacked in upright autoclaves or wheeled into horizontal autoclaves with capacities of  $0.5\text{--}10\text{ m}^3$ . The autoclaves are heated directly or indirectly with steam at  $130\text{--}135^\circ\text{C}$ . The heating is carried out so that after about four hours a pressure of 4–5 bar has built up. The autoclave is then emptied; the  $\alpha$ -hemihydrate formed is immediately transferred in the baskets to a chamber to be dried at  $105^\circ\text{C}$  under atmospheric pressure. It is subsequently ground to the desired particle size and size distribution. Variation in pressure and temperature during dehydration and drying can be used to affect the properties of the products (Table 56.18).

$\alpha$ -Hemihydrate is often mixed with  $\beta$ -hemihydrate. For that reason processes have been developed that produce a mixture of  $\alpha$ - and  $\beta$ -hemihydrates in a single operation [123]. In one such process the  $\alpha$ -hemihydrate is dried in a rotary kiln, which at the same time serves to both calcine the  $\beta$ -hemihydrate and blend the two types of material.

Table 56.20: Examples of characteristic energy data in manufacturing calcined gypsum.

| Parameter                                    | Rotary kiln<br>( $\beta$ -hemihydrate) | Kettle<br>( $\beta$ -hemihydrate) | Conveyor kiln<br>(Putzgips) | Autoclave<br>( $\alpha$ -hemihydrate) |
|--|--|-----------------------------------|-----------------------------|---------------------------------------|
| Calcined gypsum capacity, t/d                | 600                                    | 760                               | 1200                        | 150                                   |
| Theoretical energy requirement, kJ/t         | 598 600                                | 584 000                           | 770 400                     | 560 000                               |
| Practical energy requirement, kJ/t           | 892 000                                | 800 000                           | 1 100 000                   | 1 590 000                             |
| Thermal efficiency, %                        | 67                                     | 73                                | 70                          | 35                                    |
| Moisture content of gypsum rock, %           | 1.5                                    | 1.5                               | 1.6                         | 0.0                                   |
| Crude gypsum purity, %                       | 90.0                                   | 90.0                              | 94.0                        | 95.0                                  |
| Water of crystallization, raw gypsum, %      | 18.8                                   | 18.8                              | 19.7                        | 19.9                                  |
| Water of crystallization, calcined gypsum, % | 3.0                                    | 5.5                               | 1.0                         | 5.8                                   |

**Process Control.** Dry gypsum calcining processes are usually equipped with dry dust collection systems. The amount of dust formed depends on the type of calcining unit. For the most part electrostatic filters are used for dust collection, but recently mechanical filters have also been used (see the B Series). Sieves and grinders, as well as conveying equipment, for calcined gypsum are fitted with flat screen-type filters for internal dust collection. The dust collected is added to the calcined gypsum.

The water liberated in the process is discharged as vapor through outlet stacks into the atmosphere. There are no wastes or by-products. No environmental problems are encountered, provided the processing of the gypsum plaster proceeds normally.

The energy consumption of a gypsum plant is the sum of the fuel used in the calcination of the gypsum and the electric power needed to operate the machinery. Table 56.20 shows the energy consumption of various types of processes based on experience. Mainly oil and gas have been used as the fuel. However, coal is being used increasingly, chiefly in grate firing, pulverized coal firing, and fluidized firing systems [124]. To improve the energy consumption of these units, the design is optimized and the waste heat is utilized. At the same time large modern gypsum plants are increasingly using automatic process control.

### 56.6.3.2 FGD Gypsum to Calcined Products

FGD gypsum is used directly as a major raw material by the gypsum and the cement industries.

### $\beta$ -Hemihydrate and Multiphase Plasters

FGD gypsum is a finely divided powder with less than 10% surface moisture. It therefore differs considerably in its state of aggregation from natural gypsum and requires treatment not needed for natural gypsum.

To produce  $\beta$ -hemihydrate for the manufacture of gypsum plasterboards and other gypsum building components, FGD gypsum must be dried before calcination. This can be carried out in cocurrent drying units in which the hot gases come into direct contact with the moist gypsum (e.g., flash dryers), or in tube dryers heated indirectly with steam. After drying the gypsum is calcined to  $\beta$ -hemihydrate in kettles [125, 126].

FGD gypsum used for the production of multiphase plaster and gypsum building plaster must be treated further. Its particle structure, which ranges from cubic (bulk density  $1200\text{ kg/m}^3$  narrow particle size distribution ( $40\text{--}60\text{ }\mu\text{m}$ )) are unsuitable for the production of multiphase plaster [127]. It is this particle structure that is the cause of its thixotropy if it is used as multiphase plaster. As plaster it also lacks smoothness, and its volume yield is too variable.

Agglomeration processes have been developed to modify the particle structure of flue-gas gypsum and convert it into a lump product. Of all the agglomeration processes—briquetting with a compacting press, granulating with extrusion presses, pelletizing—briquetting has proved the most effective and is the most widely accepted. In this process the flue-gas gypsum is compacted in the dry state without addition of bonding agents or additives to

produce briquettes 2 cm thick and 6 cm long, in their mechanical properties comparable to natural gypsum [128].

Their point strength exceeds 500 N, and their apparent density is  $\approx 2.15 \text{ g/cm}^3$ . These briquettes are exceptionally abrasion resistant. They can be stored in the open and are unaffected even by frost or rain. In this form all types of flue-gas gypsum have bulk density of  $\approx 1.1 \text{ t/m}^3$  and can be used alone or mixed with natural gypsum.

Figure 56.24 shows a flow diagram for a plant processing FGD gypsum by drying and briquetting. Several of these plants operate in Germany.

The flue-gas gypsum briquettes can be processed to multiphase gypsum plaster in the calcining units used for natural gypsum.

The extra energy input per tonne of dry  $\text{CaSO}_4 \cdot 2\text{H}_2\text{O}$  consists of (a) 550 000 kJ of thermal energy and 12 kWh of electrical energy for drying to 10% moisture and (b) 10 kWh of electrical energy for agglomeration into briquettes.

The value of FGD gypsum can be established from a cost comparison between pro-

cessing FGD gypsum and natural gypsum. A second major factor is the transport of the FGD gypsum from power station to gypsum plant. In comparison with the transport of natural gypsum from the quarry to the gypsum plant, the transport of FGD gypsum is associated with additional costs, e.g., for intermediate storage due to seasonal differences in production of the power station and consumption of the gypsum plant.

For a gypsum plant the long-term security of supply of FGD gypsum is vital. In times of FGD gypsum shortages it must therefore be possible to fall back on natural gypsum. The surplus quantities of FGD gypsum that will be available in the future in parts of Europe should be placed in intermediate storage locally in artificial deposits as a future raw material reserve. An environmental compatibility study is at present being prepared. With such a gypsum reserve it would be possible to fulfill the requirement of the gypsum industry for an assured long-term supply of raw material over the life-time of the power station [101, 129].

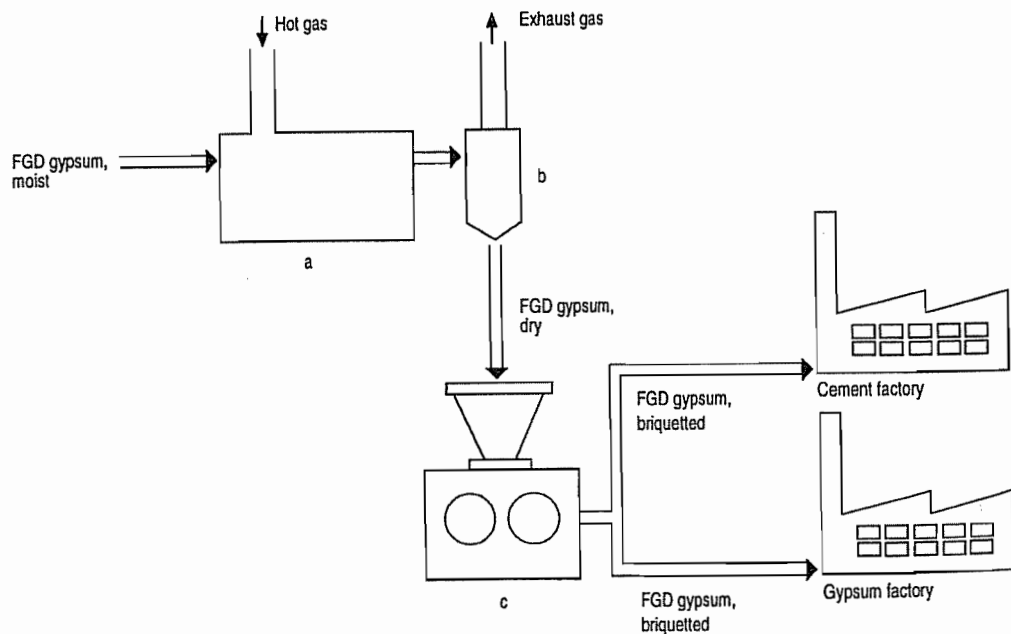

Figure 56.24: Flowsheet of a FGD gypsum drying and briquetting plant: a) Dryer; b) Cyclone; c) Press.

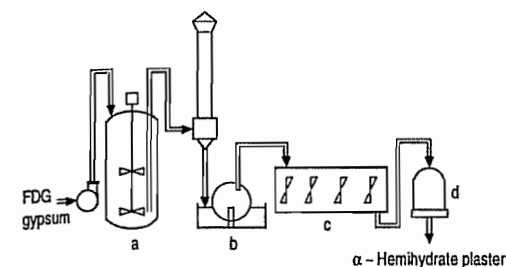

Figure 56.25: Production of  $\alpha$ -hemihydrate plaster by the continuous autoclave process (Nitto Gypsum-Knauf): a) Autoclave; b) Expander; c) Vacuum filter; d) Dryer; e) Pulverizer.

### $\alpha$ -Hemihydrate Plaster from FGD Gypsum

FGD gypsum is an ideal raw material for manufacturing  $\alpha$ -hemihydrate plaster by the continuous autoclave process (Nitto Gypsum-Knauf). The gypsum is used in its original moist, finely divided state without predrying. In the continuous autoclave process, shown schematically in Figure 56.25, FGD gypsum having a free water content of 10% is slurried with water (one part gypsum, two parts water) and pumped continuously into the autoclave where it is dehydrated to  $\alpha$ -hemihydrate under controlled conditions ( $135^\circ\text{C}$ , 2 h). Additives in the suspension change the crystal habit of the  $\alpha$ -plaster and yield a product of defined, consistent properties. The  $\alpha$ -hemihydrate produced is withdrawn as an aqueous suspension and dewatered in a vacuum filter. The product that has a free water content of  $\approx 10$ –15% is immediately dried at  $\approx 150^\circ\text{C}$  in an indirectly heated dryer and ground. This dry  $\alpha$ -hemihydrate can then be used for all types of  $\alpha$ -hemihydrate plasters and products.

Today the continuous autoclave process is also used industrially for the processing of finely divided natural gypsum and synthetic gypsum.

Another  $\alpha$ -hemihydrate plaster process was recently developed especially for utilizing lignite FGD gypsum (ProMineral-SICOWA). The moist, finely divided FGD gypsum is mixed with auxiliaries, pressed into stable stackable blocks and converted into  $\alpha$ -hemi-

hydrate plaster in large hot pressure autoclaves. The resulting blocks of  $\alpha$ -gypsum are dried and ground. Important applications for this type of  $\alpha$ -gypsum are the manufacture of self-levelling floor plaster, floor slabs and mining mortar.

Other continuous autoclave processes have ceased operations within a few years (Giulini), never got beyond the pilot stage (ICI), or remained dormant in patents.

Processes in which  $\alpha$ -hemihydrate is produced without pressure in sulfuric acid, nitric acid, or salt solutions are found in the literature, but they never came into operation.

All efforts to produce an  $\alpha$ -hemihydrate plaster similar in its properties to  $\beta$ -hemihydrate plaster have so far been unsuccessful.

### 56.6.3.3 Phosphogypsum to Calcined Products

Moist, finely divided phosphogypsum is a waste from the production of wet phosphoric acid [67]. It is available as filter cake with free water content of 20–30%. The content of impurities is high and the impurities must be removed or rendered harmless by operations such as washing, flotation, and recrystallization before phosphogypsum can be used by the gypsum industry.

All phosphogypsums contain inorganic impurities such as phosphates, nitricfluorides, and sodium salts. They affect the properties of the gypsum.

Organic impurities and small amounts of radiation ( $^{226}\text{Ra}$ ) are present in sedimentary phosphate rocks (Morocco), part of which appears in the gypsum. Magmatic phosphate rocks (Kola) contain no organic impurities and no radioactive matter.

The unsuitable crystal shape of all phosphogypsums must be modified by fine grinding or by recrystallization.

The one- and two-stage phosphoric acid processes that have been developed for the manufacture of wet phosphoric acid produce different qualities of phosphogypsum. In the

one-stage processes, phosphogypsum is obtained as dihydrate (dihydrate process, e.g., that of Prayon, altogether representing 84% of all phosphogypsum produced) or hemihydrate (hemihydrate process, e.g., that of VEBA [130] or Fisons [131], but representing less than 1%).

In the two-stage phosphoric acid processes, either gypsum or hemihydrate is produced in the first stage. In the second stage it is converted to another state of hydration before being removed by filtration. These processes include the hemihydrate-dihydrate process (e.g., Nissan [132]; 15% of all phosphogypsum produced) and the dihydrate-hemihydrate process (e.g., Central Prayon [133], less than 1%). Generally, gypsum obtained from the two-stage processes is of better quality in regard to inorganic impurities such as phosphate, fluorine, and sodium.

The gypsum industry is faced with the need for recovery operations if it attempts to use phosphogypsum [134, 135]. Removal of organic impurities, which discolor the gypsum, and of water-soluble inorganic contaminants, which cause efflorescence, involves first remashing the phosphogypsum with water, then subjecting it to flotation, classification (hydrocyclone), thorough washing, and filtering. Up to 5 t of water per tonne of phosphogypsum is consumed. Gypsum purified in this way is obtained as filter cake with a free water content of 20–30%.

For production of  $\beta$ -hemihydrate intended for gypsum building components the filter cake is dried (e.g., rapid dryer from Hazemag, or the contact dryer from Serapic) and then calcined to  $\beta$ -hemihydrate in the same way as finely ground natural gypsum. Today this method is still the principal one used by the gypsum industry in Japan, where this method was developed in 1940 by Yoshino.

For use in gypsum building plaster and multiphase plaster, phosphogypsum is made unsuitable by its particle shape, fineness, and isomorphous acid phosphate impurities. Its particle shape and fineness seriously impair the workability of the multiphase plaster, i.e., the plaster is thixotropic. The cocrystallized

acid phosphates cause calcined products to develop lime sensitivity, which interferes with setting and development of the strength [136].

In order to overcome these deficiencies the phosphogypsum is dried, calcined, and after addition of aqueous calcium hydroxide suspension simultaneously agglomerated and recrystallized in a pelletizer. Such alkaline-recrystallized pellets are used as starting material for gypsum building plaster and multiphase plaster.

In one process *phosphohemihydrate* gypsum is the starting material. If the process is carried out with adequate care, the phosphohemihydrate is sufficiently pure that the gypsum recovery phase can be dispensed with. The fine phosphohemihydrate, having a residual water content of  $\approx 20$ –25%, is mixed immediately with a calcium hydroxide suspension or calcium hydroxide powder so that the calcium sulfate crystallizes into coarse-grained dihydrate. Part of the moisture and all of the acid phosphate are bound chemically, and the particle size and structure are satisfactory.

The phosphogypsum pellets or lumps thus produced can then be calcined and further processed in rotary kilns or, after grinding, in kettles to produce a  $\beta$ -hemihydrate plaster similar in composition to plaster of Paris. They can be converted on a conveyor grate into overburnt plaster, which consists of coarse particles and is comparable to multiphase plaster. These plasters can be processed into all kinds of machine-applied and premixed plasters.

Such processing methods were developed and put into operation by Knauf in 1962 and 1970. Most other processes designed to use phosphogypsum (e.g., those of Rhône-Progil, Charbonnages de France, Chimie-Air Industrie, Imperial Chemical Industry, Buell) have not resulted in viable commercial operation.

The recovery operations required by phosphogypsum involve additional capital expenditure and operating costs, jeopardizing its competitiveness with natural gypsum and generally rendering phosphogypsum uneconomical for commercial use. The repercussions felt after the first energy crisis, in 1973, because

the extra treatment is energy intensive, were an additional set-back.

Phosphoric acid producers do not pay for the extra treatment required by the gypsum manufacturer. In summary, the conclusion must be drawn that the chance of phosphogypsum ever being utilized on a large scale worldwide is extremely remote, even though disposal of phosphogypsum is becoming more of a problem [104].

Only Japan has so far managed to continuously use phosphogypsum, an accomplishment favored by its total lack of natural gypsum resources. South Korea also uses phosphogypsum as a source of gypsum.

### 56.6.3.4 Anhydrite Plaster

Anhydrite plaster is produced by grinding anhydrite rock in tube mills or impact pulverizers to a particle size below 0.2 mm. Activators to promote setting are added together with the gauging water. However, the very fine grinding is expensive.

The activators are mixtures of alkali-metal or heavy-metal salts and calcium hydroxide, up to  $\approx 2\%$  of the anhydrite. Acid activators, e.g., potassium hydrogensulfate or iron(II) sulfate, can also be used [138].

Fluoroanhydrite, a dry fine powder, is neutralized with calcium hydroxide and ground very finely for use as an anhydrite plaster. Sulfates, e.g., potassium sulfate and zinc sulfate, and calcium hydroxide or Portland cement are activators [139], which are usually added and mixed with the anhydrite powder in the factory.

Natural anhydrite and fluoroanhydrite differ from each other in crystal structures. Fluoroanhydrite consists of very small primary crystals that have been agglomerated to secondary particles with a high specific surface area and high reactivity, whereas natural anhydrite consists of large primary particles, which are rendered reactive by fine grinding.

Recently, a process has been developed for the manufacture of thermal anhydrite from FGD gypsum using the suspension gas calcining process (POLCAL<sup>®</sup> process). The appara-

tus consists of one or more preheating cyclones, a reactor with integrated separating cyclone, and a cyclone coder. The conversion temperature is above 700 °C, and the residence time of the small gypsum particles in the reactor is a few seconds.

Thermal anhydrite from FGD gypsum is used as a binder component in self-levelling floor plasters [101].

## 56.6.4 Use and Properties of Gypsum Plasters and Products and Anhydrite Plasters

### 56.6.4.1 Hydration, Setting, Hardening

Calcium sulfate hemihydrate, anhydrite III, and anhydrite II undergo hydration under ambient conditions, converting into calcium sulfate dihydrate. If hydration is carried out with just enough water to produce a homogeneous, fluid, stable, nonsedimenting slurry, then this mixture sets and hardens because the calcium sulfate dihydrate forms needles that intergrow and interlock.

Much research has gone into the mechanism of hydration. Around 1900, LE CHATELIER [140, 141] established the theory of crystallization, which gained universal acceptance [142, 143]. According to this theory the calcium sulfate hemihydrate in water first forms a saturated solution, about 8 g/L at 20 °C. However, this solution is actually supersaturated, because at 20 °C calcium sulfate dihydrate has a solubility of only 2 g/L, and  $\text{CaSO}_4 \cdot 2\text{H}_2\text{O}$  precipitates.

CAVAZZI [145], and later BAYKOFF [146], put forward a colloid theory, which states that the hydration proceeds via a colloidal intermediate involving formation of a type of gel or an adsorption complex between the calcium sulfate hemihydrate and water. However, this gel has not yet been demonstrated experimentally.

In recent years the Le Chatelier theory of crystallization has been supplemented by the detection of topochemical reactions taking place during hydration [147]. The two mecha-

nisms are not mutually exclusive, because transformation into dihydrate in both cases takes place via the solution phase. The topochemical hydration is an internal hydration of the hemihydrate particles taking place over very short distances.

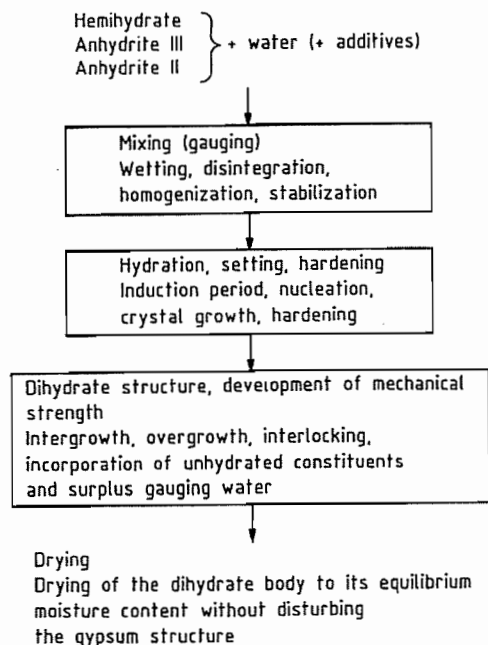

Figure 56.26: Stages of hydration, setting, and hardening of calcium sulfates.

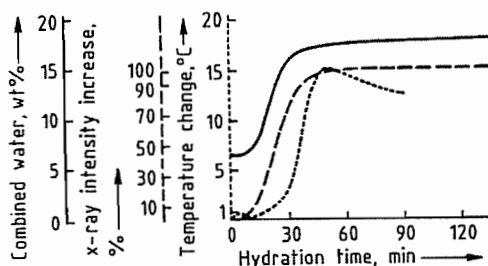

Figure 56.27: Rate of hydration of  $\beta$ -hemihydrate demonstrated by combined water content (—), intensity of x-ray diffraction (---), and temperature increase from heat of hydration (···) [150].

Formation of dihydrate crystals conforms to the laws of nuclei formation and crystal growth (Figure 56.26). Mixing and wetting of the hemihydrate powder, which causes disintegration of the hemihydrate particles, is fol-

lowed by a short induction period, after which nuclei begin to form from the supersaturated solution. The accumulation of very small dihydrate crystals with much excess water has been described by KRÖNERT et al. as clustering [148]. Subsequently, after this nucleation, crystal growth begins, which at least initially is accompanied by continuous recrystallization [144]. The rate of nuclei formation is proportional to the relative supersaturation (von Weimarn's theory), and the rate of crystal growth is proportional to the absolute supersaturation (Nernst–Noyes equation). Hemihydrate is converted directly into dihydrate; there are no intermediate stages. Anhydrite III is converted via the hemihydrate, and anhydrite II is converted directly into dihydrate, without anhydrite III or hemihydrate intermediates. If the proportion of water is correct for setting and hardening, the slurry hardens by forming a dihydrate structure, a final crystallization, which according to LUDWIG et al. [149] consists of intergrown, overgrown, and interlocking dihydrate crystals and inclusions of unhydrated components. Excess water can be removed by drying.

The rate of hydration of  $\beta$ -hemihydrate as shown in Figure 56.27 is demonstrated by combined water content, intensity of the X-ray diffraction, and rise in temperature due to the heat of hydration [148].

There are many ways in which these processes of hydration, setting, and hardening can be applied in practice. Parameters for characterizing these processes are the water-to-plaster ratio on mixing, the consistency of the mixture, the initial and final set, the rate of strength development, and the strength and density of the final dry gypsum product.

The method of manufacture of the plaster influences the gypsum technology to a very large extent. For instance,  $\beta$ -hemihydrate from a rotary kiln requires more water to produce a fluid slurry of uniform consistency than does plaster from a kettle. The latter, in turn, requires more water than multiphase plaster, which, in turn, requires more than autoclave plaster. This water-to-plaster ratio (water capacity of the gypsum plaster), an inverse of the

quantity of gypsum plaster in grams per 100 g of water, is related to the strength and density of the set and hardened gypsum product.

$\alpha$ -Plasters, which are workable with little water, can be simply turned into gypsum products of high strength and high density. However, these products are avoided in the building industry on account of their brittleness.

$\beta$ -Plaster and multiphase plaster require more water than  $\alpha$ -plaster to obtain a fluid consistency. They produce products of average strength, higher elasticity, and lower densities, and are used universally in the construction industry.

The particle shape, particle-size distribution, and specific surface area also determine the quantity of water required to give a specific consistency. Generally, very fine plaster requires more water than coarse-grained plaster. Rod-shaped particles also increase the amount of water needed.  $\beta$ -Hemihydrate particles may disintegrate on first contact with water, breaking up into a multitude of very fine loose particles, thus changing their particle size distribution [151]. The particle size distribution of multiphase plasters determines their workability to a great extent.

When stored, calcined gypsums are subject to changes in their properties, called *aging*. This aging is caused to some extent by the uptake of water vapor from the air. The degree of aging affects the water needed for given consistency; more water is needed for fresh calcined gypsum than for aged. If a considerable amount of water vapor is adsorbed, dihydrate nuclei may form, accelerating the hydration process. However, the reactions taking place on aging have not yet been entirely elucidated [150, 152]. Natural aging of calcined gypsum produces gradual changes in the properties of the plaster over a period of months. To avoid this, methods have been developed to bring about aging artificially, so that the plaster undergoes no significant changes during storage. One process is called aridization: calcium chloride or similar salts are added in quantities up to about 0.2% to the raw gypsum before calcination [153]. Aging of calcined gypsum

is also achieved by injecting small quantities of water containing a wetting agent to prevent the formation of a dihydrate [154, 155].

The mixing and gauging of calcined gypsum with water to form a slurry of specific consistency can be affected by various wetting agents. Most of these, called *plasticizers* or water-reducing agents, lower the water demand. They include alkylarylsulfonates, lignosulfonates, or melamine resins [156]. It is also possible to increase the water requirement by adding flocculating agents, e.g., polyethylene oxide [157]. Chemicals that thicken, e.g., cellulose and starch ethers, can be added to stabilize the water plaster slurry or prevent sedimentation and segregation; however, these have little effect on water demand [158].

Setting and hardening can be accelerated or retarded by numerous additives [159, 160]. Many inorganic acids and their salts are useful as *accelerators*, especially sulfuric acid and its salts. Calcium sulfate dihydrate is regarded as a special additive in this respect. Finely divided, it acts as a strong accelerator and therefore must be completely removed when raw gypsum is calcined. The accelerating effect of these substances is due to an increase in solubility and the rate of dissolution of the calcined gypsum and to an increase in the rate of nuclei formation.

Retarders are usually organic acids [161] and their salts and organic colloids that are the decomposition and hydrolysis product of biopolymers such as proteins as well as salts of phosphoric acid or boric acid. The mechanism of retardation varies: high molecular mass colloids prolong the induction period because they are nuclei poisons. Other retarders slow down the rate of dissolution of the hemihydrate or the growth of the dihydrate crystals. The hydration of anhydrite II usually does not have to be retarded since it is slow enough and almost always requires acceleration.

In every case, temperature affects the rate of hydration of plaster, the rate increasing up to  $\approx 30^\circ\text{C}$ , after which it decreases [162].

The *strength* of set dried gypsum is directly proportional to its density, therefore dependent only on its porosity or, less directly, on

the water-to-plaster ratio and the size and structure of the pores [163, 164]. The strength is affected by moisture or additives without a change in density. The strength of gypsum products with a moisture content exceeding 5% is only about one half that of air-dried gypsum products. When a gypsum product dries, the strength begins to increase below 5% moisture content, becomes evident around 1% moisture content, and reaches its final value in the region of its equilibrium moisture content [65].

Persistently moist conditions reduce strength, because crystalline and textural changes, especially recrystallization, take place as a result of the solubility of gypsum in water [165]. The deformation or creep of moist gypsum products under mechanical stress is likewise the result of structural change. Additives induce a change in structure by changing the crystal habit of the dihydrate so that without a change in density strength is changed even in the dry state.

An extreme example of reducing strength is the effect of citric acid, commonly used as a retarder. Used sparingly, less than 0.1%, it does have a retarding effect and lessens the strength only slightly. More, say, above 0.2%, changes the crystal habit of the dihydrate to such an extent that hardening of the gypsum is no longer possible because the crystals no longer interlock and intergrow [166].

MURAT [167] has studied the morphology of natural and synthetic calcium sulfate dihydrates with up-to-date techniques and the effects of additives upon the crystal habit of the dihydrate.

#### 56.6.4.2 Prefabricated Gypsum Building Components

Prefabricated gypsum building components are manufactured in large quantities: plasterboards, partition panels, ceiling tiles, and fiber-reinforced boards. These are light, porous, dry, and nonbrittle products possessing excellent workability.  $\beta$ -Hemihydrate is the starting material for all these because it sets quickly and easily meets the building industry's de-

mand for certain properties for the finished product.

The plants for the manufacture of gypsum building components are usually built adjacent to gypsum works.

Gypsum *plasterboards* are large thin gypsum panels covered with cardboard; they have a density of 750–950 kg/m<sup>3</sup>. They are manufactured by feeding  $\beta$ -hemihydrate plaster into a continuous mixer from controlled feeding devices, mixing it continuously with water and additives, e.g., adhesives, to form a homogeneous and rapidly setting slurry. This slurry is spread on a continuous sheet of cardboard about 0.5 mm thick (200–300 g/m<sup>2</sup>). The slurry is then covered with a second sheet of cardboard and passed over a molding platform to be shaped into a completely encased strip, 1.20–1.25 m wide and 9.25, 12.5, 15.0, 18.0, or 25.0 mm thick. This strip of gypsum plasterboard, initially soft, hardens within minutes and is cut into separate panels. These panels, with approximately one third of their weight being free water, are dried immediately in a continuous tunnel dryer heated either indirectly with steam or directly with gas or oil. The finished gypsum plasterboard, consisting of a gypsum core tightly encased and bonded to cardboard, is considered to be a laminated building material.

Many different types of gypsum plasterboards are manufactured, depending on their intended use. Distinctive features are size, edge configuration, weight, water resistance, structural behavior, and strength. Gypsum plasterboards with specific fire-resistant properties incorporate fiberglass. The noncombustible gypsum lightweight board is a recent development, making use of a laminate of glass fiber mat with a lined-on glass silk scrim to replace the cardboard [168]. Modern plants for the manufacture of plasterboards have a capacity of about (20–40)  $\times 10^6$  m<sup>2</sup> per year and an annual consumption of 150 000–300 000 t of hemihydrate plaster.

Plasterboard is used in interior finishing, e.g., for wall and ceiling panelling. It is screwed to wooden or metal frames or pasted on masonry or concrete with special building

plaster (adhesive plaster, the German *Ansetzgips*). The joints are covered and finished with special paper and joint filler to form a smooth surface. Plasterboard can also be used for the construction of dismantable partitions and lightweight dividing walls having various characteristics (weight, sound proofing, fire resistance) in concrete or steel-framed buildings as well as in prefabricated dwellings. Plasterboard undergoes further processing in factories into special-sized panels, coffers, or lightweight laminated panels with intermediate layers of polystyrene or polyurethane, the last called insulating board. Multilayered plasterboards are used for dry floorings and for the construction of lift shafts. Factory-made tiles with decorative surface finishes such as plastic sheet or special coats of paint or else an aluminum foil to prevent water vapor transmission are available.

Gypsum *partition panels* consist of set gypsum plaster. To produce them  $\beta$ -hemihydrate plaster is mixed with water (water-to-plaster ratio 0.9–1.0) and the slurry, which sets quickly, is poured into molds. After 5–8 min the panels are taken out of the molds and dried [169].

The standard size of gypsum partition panels is 500  $\times$  666 mm, with a thickness of 60, 70, 80, or 100 mm and a density of 700–900 kg/m<sup>3</sup>. They are used in interiors as lightweight dividing walls, the tongue and groove joints being bonded with joint plaster. The partition walls can be single or multilayered. Characteristic features are low weight, average to good sound insulation, and excellent fire resistance.

Gypsum *ceiling tiles* are produced by mixing  $\beta$ -hemihydrate, water, and small amounts of glass fiber and pouring the slurry into rubber molds. The molds allow for designs of individual choice.

Ceiling tiles are used as decorative tiles, ventilation tiles, heating tiles, or sound-proofing tiles with mineral wool bonded on the back. They are screwed to a base frame and fitted into the framework. They are normally 625  $\times$  625 mm in size and weigh between 10 and 20 kg/m<sup>2</sup>.

Gypsum *fiber board* and fiber-reinforced gypsum elements are another group of gypsum building components manufactured from hemihydrate plaster and paper fibers, glass fibers, or another type of fiber material [170–174]. Glass fiber, as mat or web, can be incorporated [175]. The proportion of fiber in these components, evenly distributed in the plaster, ranges up to 15%. These fiber boards have an apparent density between 800 and 1200 kg/m<sup>3</sup>.

Factories for the manufacture of gypsum partition panels and ceiling tiles have capacities up to 1 000 000 m<sup>2</sup>/a, consuming about 50 000 t/a of hemihydrate plaster, or else gypsum fiber boards up to 10  $\times 10^6$  m<sup>2</sup>/a, consuming the same amount of hemihydrate.

#### 56.6.4.3 Gypsum Plaster

Calcined gypsum is used for plastering. Best is multiphase plaster (Table 56.19) because its phase composition results in quick initial setting and gradual final setting; smoothness, plasticity, and high coverage; single-coat application without additives or aggregates; rapid drying of the finished plasterwork; and suitable density and high strength.

$\beta$ -Hemihydrate plaster without additives is not suitable for plastering because the initial setting occurs too late and the final setting too early. Also its particle size distribution is not suitable for plaster. However, additives permit  $\beta$ -hemihydrate to be made into certain types of plastering material, known as retarded hemihydrate gypsum plaster and premixed lightweight gypsum plaster. Because of inadequate setting properties, lack of smoothness, and insufficient coverage,  $\alpha$ -plasters are not used in construction [65, 176].

Over the past twenty years considerable progress has been made in Germany towards development of a factory-made machine-applied gypsum plaster. Ordinary multiphase plaster is used as the starting material. Mixed with additives it is processed into a material that can be used for continuous machine application in single coats. The rate of setting and

the hardening process have been adjusted to suit the longer working cycle for material applied over a large surface area. Too rapid water uptake is controlled by adding water-retaining hydrophilic colloids, e.g., methyl cellulose. In this way the soft plaster slurry remains plastic until the work has been completed, resulting in better bonding to the base. The uniformity of the properties and the homogeneity of these plasters are particularly good when they are manufactured in large plants.

Such plants are equipped with high-capacity mixing and handling devices (Figure 56.22) and can produce up to 400 000 t/a. At the construction site the dry plaster is fed continuously into the plastering machine (e.g., Gipsomat) where it is mixed with water at a metered rate to form a slurry applied in a single coat to the base by means of a screw pump and hose. A smooth and even surface is obtained with an electrically powered felting tool (e.g., Power Float, Gipsoglätt).

**Table 56.21:** Application properties of projection plaster, bonding plaster, and premixed plaster [64]. Tests conform to German (DIN) standard 1168 [111].

| Property   | Projection plaster | Bonding plaster | Lightweight plaster |
|--|--------------------|-----------------|---------------------|
| Water:plaster ratio                                    | 0.45–0.65          | 0.60–0.80       | 0.55–0.75           |
| Initial setting, min                                   | 60–120             | 40–90           | 40–90               |
| Final setting, min                                     | 120–240            | 60–120          | 60–120              |
| Strength of set and hardened gypsum, N/mm <sup>2</sup> |                    |                 |                     |
| Flexural strength                                      | 1–2                | 1–2             | 1–2                 |
| Compressive strength                                   | 2.5–5              | 2.5–4           | 2.5–4               |
| Apparent density of dry gypsum, kg/m <sup>3</sup>      | 1000–1200          | 850–1000        | 900–1100            |
| Coverage, m <sup>2</sup> per 100 kg of plaster         | > 60               | > 120           | > 110               |

In some countries, especially in Great Britain, the two- or three-coat method of plastering is still employed. The undercoat is browning plaster, a factory-processed hemihydrate plaster containing a retarder, which is mixed with sand or expanded perlite either in the factory or on the building site. It takes several hours to set, i.e., far longer than premixed plaster. The next day a smooth finishing coat of plaster of Paris and hydrated white lime is applied.

In France, Spain, some countries in North Africa and the Near East, and to some extent in southwest Germany, especially in the Saarland, pure multiphase plaster containing no additives (Paris construction plaster, southern

Plastering machines operated inside buildings are supplied with plaster directly from bins or containers installed just outside the building by pneumatic conveyor pumps through flexible hoses. Such a plastering machine can be operated by one person.

Premixed gypsum plasters (bonding plaster, lightweight plaster), factory-processed from  $\beta$ -hemihydrate plaster (or multiphase plaster) containing additives and aggregates, e.g., expanded perlite or vermiculite, are worked batchwise on site. The plasters are mixed with water and applied in one coat on all types of concrete and masonry. Premixed plasters already contain the necessary additives to ensure good workability. Only water need be added by the plasterer, who can then apply the plaster, independent of the weather, without fear of making a mistake. The application properties of these plasters are listed in Table 56.21.

German *Doppelbrandgips*, Saarland multiphase plaster) is used for single-coat and multicoat plasterwork. In countries with a dry climate, e.g., Iran, multiphase plaster is also used as mortar for brickwork and for external claddings.

#### 56.6.4.4 Other Uses

Anhydrite capable of setting and  $\alpha$ -hemihydrate plaster are extensively used as a binder for mining mortar and as a flooring plaster, uses where its brittleness is not a handicap [177].

Substantial amounts of natural anhydrite are consumed by the mining industry for the construction of roof supports for galleries and

ventilating air structures in coal mines. Dry mining anhydrite having a specified particle size distribution, e.g., 0–6 mm, and containing an accelerator is used in underground coal mines worked by the long-wall method. With the aid of large blowers the anhydrite is conveyed pneumatically through hoses and wetted at the site of use before being sprayed in layers to form a barrier. The anhydrite barriers rapidly develop a high initial compressive strength of about 15 N/mm<sup>2</sup>, their strength exceeding 40 N/mm<sup>2</sup> after 28 d. They serve to support the gallery and roofs in the roadways [178].  $\alpha$ -Hemihydrate plaster is also used as a binder for mining mortars [179].

Finely ground natural anhydrite, processed fluoroanhydrite and  $\alpha$ -hemihydrate plaster, all capable of setting, are used as binders for self-levelling floor plasters. When used for laying floor screeds, the cementitious material is first mixed with sand in the proportions of 2:5 and then batch-mixed with water in a pan mixer until it attains a stiff consistency. Piston pumps and hoses pump the mix to the different floors and rooms, where it is spread on the floors. More recently  $\alpha$ -hemihydrate plaster, with or without additives, mixed with water to form a fluid slurry, has been used as machine-applied floor plaster (self-levelling floor plaster). Since calcium sulfate floor screeds do not shrink, they can be laid free of joints and, when properly done, free of cracks over a large surface area.

Substantial quantities of natural gypsum, FGD gypsum, and anhydrite rock are used as a retarder for Portland and blast-furnace cements. In compliance with German (DIN) standards, the maximum permissible calcium sulfate content of cement is 3% SO<sub>3</sub> for Portland cement and 4% SO<sub>3</sub> for blast-furnace cement [180]. Gypsum rock or FGD gypsum (briquettes) or anhydrite rock, or a mixture with a particle size range 5–50 mm, is directly added to the cement clinker before grinding. It is then present in the cement in a finely divided reactive form [181]. More than 50% of the entire gypsum and anhydrite rock production is consumed by the cement industry.

In Russia a *gypsum cement* mortar is manufactured by calcination of raw gypsum in combination with certain types of cement and active silica. Because of its water-resistant properties, this mortar is used for the production of prefabricated washrooms, occasionally also for exterior wall elements of prefabricated cottages. However, pure gypsum building components have not found widespread use externally because of the solubility of gypsum in water [66, 182, 183].

$\alpha$ -Hemihydrate is used as a high-strength molding material for roofing tile, cast metal, and dental materials [69]. Mixed with  $\beta$ -hemihydrate,  $\alpha$ -hemihydrate is the favored molding plaster — especially for ceramics — because its expansion on setting and the strength and absorbency of the final mold can be varied by varying the  $\alpha$ : $\beta$  hemihydrate ratio [184]. Addition of high molecular mass compounds perhaps improves the stability of gypsum molds without adversely affecting the plaster. Molding plaster is used to make surgical casts and orthopedic bandages.

Calcium sulfate dihydrate is used as a soil stabilizer and to displace sodium in soils too high in sodium salts, e.g., those soils flooded by seawater. It also serves as a fertilizer in soils deficient in sulfur, especially in North America [185].

The classical Müller-Kühne process (gypsum-sulfuric acid-cement process) has once again become of interest for treating secondary materials such as unrefined calcium sulfite and calcium sulfate from FGD or SAP spray absorption residues (OECD Amber List AB 150) [106], gypsum wallboard or plasterboard from demolished buildings (OECD Green List GG 20) [106], or fly ash. Today in Wolfen, Germany, 100 000 t/a of cement is produced by the Müller-Kühne process [186].

Unrefined calcium sulfite and calcium sulfate from FGD or SAP spray absorption residues, together with fly ash and activating additives, can be converted to a stabilized back-filling material for landfills and mining cavers [187].

The Merseburg process for the manufacture of ammonium sulfate from natural gypsum or

phosphogypsum has never been important because the demand for ammonium sulfate has always been met from the large quantities arising as by-product in the chemical industry [188].

Anhydrite III is an effective drying agent (Drierite) in laboratories and in industry.

Fillers made from FGD gypsum have been investigated thoroughly and their application in adhesives, paints and plastics gave good results. In principle, it is possible to produce calcium sulfate fillers from FGD gypsum, but the economic situation compared to competitive fillers is unsatisfactory [189].

Also coating pigments produced from FGD gypsum for the paper industry have been developed, showing new fields of application of FGD gypsum outside the construction industry [190].

Natural gypsum and anhydrite are insufficiently pure and therefore not suitable for producing fillers and coating pigments.

In the beverage industry, especially breweries, pure natural gypsum is used to obtain and standardize the desired water hardness.

**Table 56.22:** Gypsum building materials and their properties.

|   | Plasterboard,<br>9.5 mm thick | Finished gypsum<br>projection plaster |
|---|-------------------------------|---------------------------------------|
| <i>Apparent density and porosity</i>  |                               |                                       |
| Density, kg/m <sup>3</sup>  | 900                           | 800–1200                              |
| Pore volume, %  | 60 <sup>a</sup>               | 50–65                                 |
| Pore radius, μm   | ≈ 99% > 0.05                  | ≈ 99% > 0.05                          |
| <i>Climatic properties</i>  |                               |                                       |
| Heat conductivity λ, W m <sup>-1</sup> K <sup>-1</sup> (DIN 4108)   | 0.21                          | 0.35                                  |
| Heat penetration coefficient <i>b</i> (equivalent)<br><sup>1</sup> / <sub>2</sub> h test, J s <sup>-1/2</sup> m <sup>-2</sup> K <sup>-1</sup> | 412                           | 1200                                  |
| 2-h test  | 489                           | 1400                                  |
| Resistance to transmission of water vapor μ (DIN 4108)  | 8                             | 10                                    |
| Water vapor absorption coefficient <i>a</i> , m/h   |                               |                                       |
| untreated surface   | 2.29                          |                                       |
| rough fiber coated  | 2.98                          | 2.5                                   |
| wallpapered   | 2.66                          |                                       |
| <i>Heat expansion and equilibrium moisture content</i>  |                               |                                       |
| Linear coefficient of thermal expansion α, K <sup>-1</sup>  | (13–20) × 10 <sup>-6</sup>    | 20 × 10 <sup>-6</sup>                 |
| Equilibrium moisture content at 20 °C and 65% relative humidity, %  | 0.6–1.0                       | 0.3                                   |
| Modulus of elasticity, N/mm <sup>2</sup>  | 2000–2500                     | 2800                                  |

<sup>a</sup>Core.

Processes for the manufacture of calcium sulfate whiskers, developed in the United States and Japan, have not yet become established [191].

Pure finely ground anhydrite has found a ready market in the glass industry as a substitute for sodium sulfate because of its low price.

#### 56.6.4.5 Properties of Gypsum Building Products Installed in Situ

Gypsum building materials are suitable for the construction of non-load-bearing interior finishes in dry locations. Gypsum building components and prefabricated units are dried at the factory. Gypsum plasters dry after application, with ventilation within a few days. These plasters adhere to the base well [192, 193]. Once gypsum building materials are sufficiently dry, i.e., moisture content < 2%, they can be decorated immediately with interior coatings, wallpaper, ceramic tiles, and other facings. The surfaces of gypsum building materials are inert [194].



**Figure 56.28:** Structure of set and hardened gypsum (scanning electron micrograph). The structure shown in the photograph of set hemihydrate plaster is typical of re-hydrated gypsum: the characteristic features are determined by needle-like particles that interlock and intergrow and by the high degree of porosity (2000 ×).

Table 56.22 summarizes some of the most important properties of gypsum building products installed in situ [64, 195]. Set and hardened gypsum has low density and high pore volume and thus has a low thermal conductivity. The large pore size allows rapid absorption and desorption of water vapor, resulting in high breathing capacity. Gypsum walls and ceilings in living and working rooms feel warm to the touch; they do not sweat. Figure 56.28 shows a scanning electron micrograph of the structure of set and hardened gypsum.

Gypsum building materials have volume stability, only slight changes in size resulting from changes in temperature or moisture content. Their equilibrium moisture content is below 1%; however, permanent wetting and continuous exposure to temperatures above 60 °C change the crystal structure, and should be avoided.

Gypsum building materials promote fire protection because of the combined water of the dihydrate, which, in case of fire, evaporates, not allowing the other surface of the gypsum to reach much above 100 °C. Plasterboard and fiber-reinforced gypsum boards retain their structural integrity during exposure

to fire because of the fibers in the material [63, 196].

### 56.6.5 Material Testing and Chemical Analysis

#### 56.6.5.1 Standards

Today there are international standards for gypsum products (ISO — International Standards Organisation), European standards (CEN — Comité européen de coordination des normes), and national standards (e.g., DIN, Germany; AFNOR, France; B.S., United Kingdom; ASTM, United States; GOST, Russia; J.I.S., Japan).

Eurogypsum, the Association of European Gypsum Industries, through its scientific and technical committee, constantly exchanges information with the International Standards Organisation [197] and RILEM, the International Union of Testing and Research Laboratories for Materials and Structures. The German standards for gypsum comprise material standards [111, 198–201] and application standards [202–215].

European standards (EN) for gypsum building materials are in preparation. Quality assurance systems and standards, in accordance with ISO 9000, are being introduced into the gypsum industry.

#### 56.6.5.2 Testing

The German (DIN) standard methods of testing for gypsum building plasters comprise tests on particle size by sieving, initial set with a water:plaster ratio defined by the water capacity of the plaster or the spread in a flow table test, flexural strength, compressive strength, and hardness. A test for bond strength, e.g., for bonding plaster to concrete, is also recommended. Gypsum partition panels and gypsum ceiling tiles are characterized by apparent density, dimensions, weight, and breaking load. Plasterboards are characterized by dimensions, weight, breaking load, and permanent deflection after specified loading and unloading.



A method for determining the Blaine specific surface area is used for comparative testing [216]. A simple and inexpensive device for the determination of impact strength can be used for comparative and routine testing, especially for building components [217, 218].

The ceramic industry, which itself has not yet established any guidelines for the testing of molding plaster, determines additional properties, such as setting and final expansion and water absorption coefficient. A standardized vacuum mixer is used to gauge the gypsum slurry and to remove air bubbles from the mixture [219].

Classification of gypsum building materials with regard to their behavior during fires is set out in DIN 4102. Gypsum building materials come within Class A, rated as noncombustible building materials. Materials with no combustible components (such as plaster, partition panels, and ceiling tiles) are classified as Class A1. Gypsum plasterboard is classed as Class A2. For materials classified under Class A2 there are limits for smoke density and toxicity.

Gypsum building materials and components that comply with DIN 4102 are ideal for structures ranging from fire-retardant to highly fire-resistant walls, partitions, ceilings, steel columns, and supporting beams. Test certificates issued for built-in components are based on compliance with Classes F30, F60, F90, F120, and F180 — fire retardant to highly fire resistant. The figures 30–180 denote the fire resistance rating (period of time in minutes) of the components for a given temperature–time curve.

### 56.6.5.3 Chemical Analysis

Conventional chemical analysis [57] is used in arbitrational analysis. Free water content in raw gypsum, calcined gypsum, and set and hardened gypsum is determined by drying at 45 °C. Combined water content is determined by drying at 360 °C.

Calcium sulfate in solution is qualitatively determined by precipitation of syngenite,  $\text{CaSO}_4 \cdot \text{K}_2\text{SO}_4 \cdot \text{H}_2\text{O}$ .

Today the following methods of analysis are used for routine quantitative testing in the laboratories of the gypsum industry: complexometric titration of calcium and magnesium; flame photometry for sodium and potassium; and atomic absorption for sodium, potassium, magnesium, calcium, strontium, iron, aluminum, and sulfate, the last indirectly, via barium [220]. The phosphates contained in phosphogypsums are determined spectrophotometrically or gravimetrically with ammonium molybdate. Water-soluble, citrate-soluble, and total phosphates are distinguished. Fluorine can be determined titrimetrically. Organic substances can be determined by oxidation with potassium permanganate. Acidity is determined by titration with alkali using methyl orange or bromophenol blue. Calcium sulfite is determined via  $\text{SO}_2$ ; chlorine, by the Volhard method or with a chloride electrode.

### 56.6.5.4 Phase Analysis

Phase analysis differentiates between dihydrate, hemihydrate, anhydrite III, and anhydrite II, including its three reaction stages AII-s, AII-u, and AII-E. This differentiation of calcined gypsum according to phases is not possible by chemical analysis.

Phase analysis can be carried out by x-ray diffraction, infrared spectroscopy, microscopy, and calorimetry. However, it takes considerable experience to reach  $\pm 5\%$  accuracy [221]. The conventional method in any industrial laboratory is the gravimetric determination utilizing the differing rates of hydration [55, 57, 222, 223].

The determination of dihydrate is not especially accurate, particularly when small quantities ( $\leq 5\%$ ) are involved. In such cases, however, an exact determination is possible by differential thermal analysis [224, 225].

The determination of anhydrite II by exposure to moisture is a matter of definition. Thus the anhydrite hydrating within three days is designated as AII-s, anhydrite hydrated in seven days as AII-u, and anhydrite that after seven days remains nonhydrated is assigned to

the nonhydrated constituents and can be determined by an additional measurement. (By the addition of a 1% aqueous potassium sulfate solution in place of distilled water the seven-day period can be reduced to a few hours [55].) The stages AII-s and AII-E can be distinguished from each other by measurements of the pH value, which for AII-E is above 9, but is otherwise 6–7.

Distinction between  $\alpha$ - and  $\beta$ -hemihydrates is not possible by hydration methods. Today  $\alpha$ -hemihydrate and  $\beta$ -hemihydrate are usually determined by microscopy, the quantitative proportions are simply estimated.

### 56.6.6 Economic Aspects

The estimated world consumption of natural gypsum and natural anhydrite in the gypsum and cement industries was ca.  $95 \times 10^6$  t/a in 1995.

The cement industry, as the largest consumer of raw gypsum and raw anhydrite, used ca.  $55 \times 10^6$  t/a for a world cement production of  $1400 \times 10^6$  t in 1995.

The gypsum industry uses ca.  $40 \times 10^6$  t/a natural gypsum and anhydrite and ca.  $5 \times 10^6$  t/a FGD gypsum. Less than  $2 \times 10^6$  t/a of phosphogypsum is used, mainly in Japan, Korea, and Europe. Titanogypsum and fluoroanhydrite consumption is less than 1 Mio t/a worldwide.

The most important gypsum building materials are gypsum plasterboards with a per capita consumption of  $8 \text{ m}^2/\text{a}$  in the United States;  $6 \text{ m}^2/\text{a}$  in Japan; and  $2 \text{ m}^2/\text{a}$  in the EU, with the highest consumption in France and Great Britain (ca.  $3 \text{ m}^2/\text{a}$ ), and the lowest in Spain and Portugal ( $0.35 \text{ m}^2/\text{a}$ ). Machine-applied plaster is important in Central Europe, and multiphase plaster in Spain, Italy, North Africa, and the Near East.

Since 1985 the demand for calcium sulfate has increased at an average annual rate of 5% in Asia, 3% in Western Europe, and 1% in North America [226].

The gypsum and cement industries will remain the prime consumers. In only a few

countries, perhaps China and the countries in Eastern Europe, the states around the Persian Gulf, and some rapidly developing areas in the Far East, is gypsum consumption expected to rise in response to increased building activities.

## 56.7 Calcium Chloride

Calcium chloride is found in small quantities, along with other salts, in seawater and in many mineral springs. It is found in higher concentrations in natural brines in California and Michigan (USA), in the mineral antarctite,  $\text{CaCl}_2 \cdot 6\text{H}_2\text{O}$ ; in the yellow colored mineral tachhydrite (from the Greek word meaning easily soluble),  $2\text{MgCl}_2 \cdot \text{CaCl}_2 \cdot 12\text{H}_2\text{O}$ ; and in the mineral chlorocalcite,  $\text{KCaCl}_3$ . Calcium chloride is reportedly also contained in small amounts in the mineral carnallite,  $\text{KMgCl}_3$  [227–230].

Calcium chloride appears to have been discovered as early as the 15th century but apparently received little attention or study until the latter part of the 18th century. All of the work was done with laboratory prepared samples because it was not commercially produced until after the development of the Solvay ammonia–soda process in the mid-1800s. This process was originally designed to produce soda ash (crude sodium carbonate). Calcium chloride was considered a waste product until uses for it were developed some years later. Its importance has grown continuously to the extent that it is now invaluable for various uses, including ice and dust control, oil well drilling, refrigeration, coal thawing, and food processing. Natural brines now account for as much as 70–75% of United States calcium chloride production [231, 232].

### 56.7.1 Physical Properties

Calcium chloride,  $\text{CaCl}_2$ , is a white, odorless, extremely water soluble salt that forms hydrates with properties as indicated in Table 56.23.

**Table 56.23:** Properties of pure calcium chloride, anhydrous and hydrates (Courtesy Allied Corp.).

| Property   | CaCl <sub>2</sub> | CaCl <sub>2</sub> ·H <sub>2</sub> O | CaCl <sub>2</sub> ·2H <sub>2</sub> O | CaCl <sub>2</sub> ·4H <sub>2</sub> O | CaCl <sub>2</sub> ·6H <sub>2</sub> O |
|--|-------------------|-------------------------------------|--------------------------------------|--------------------------------------|--------------------------------------|
| CaCl <sub>2</sub> , %                                      | 100.00            | 86.03                               | 75.49                                | 60.63                                | 50.66                                |
| mp, °C   | 772               | 260                                 | 176                                  | 45                                   | 30                                   |
| bp, °C   | 1670              | —                                   | —                                    | —                                    | —                                    |
| ρ (25 °C), g/cm <sup>3</sup>                               | 2.22              | 2.24                                | 1.85                                 | 1.83                                 | 1.72                                 |
| Heat of formation (18 °C), kJ/kg                           | -7190             | -8160                               | -9490                                | -10 980                              | -11 911                              |
| Heat of fusion, kJ/kg                                      | 256 (772 °C)      | —                                   | —                                    | —                                    | 170 (30 °C)                          |
| Heat of hydration (anhydrous salt), kJ/kg                  | —                 | -240                                | -295                                 | -600                                 | -840                                 |
| Heat of solution <sup>a</sup> (hydrate, 291 °C), kJ/kg     | -680              | -380                                | -290                                 | -50                                  | +80                                  |
| Specific heat (hydrate), JK <sup>-1</sup> kg <sup>-1</sup> | 670               | 840                                 | 1170                                 | 1340                                 | 1420                                 |

<sup>a</sup>One mol solute in 400 mol of water, except monohydrate, which is in 300 mol.

**Table 56.24:** Data for Figure 56.29 (Courtesy Allied Corp.).

| Area | Saturation curve for                 | % CaCl <sub>2</sub>   |      | Temperature, °C |       | Liquid phase contains % CaCl <sub>2</sub> |      | Solid phases   | Solid phase transition at |                     |
|------|--------------------------------------|-----------------------|------|-----------------|-------|---|------|--|---------------------------|---------------------|
|      |                                      | from                  | to   | at and below    | from  | to  | from |  | to                        | % CaCl <sub>2</sub> |
| A    | ice                                  | 0                     | 29.8 | 0               | -55   | 0   | 29.8 | ice  |                           |                     |
| B    |                                      | 0                     | 50.7 | -55             |       |   |      | ice  | 29.8                      | -55                 |
| C    | CaCl <sub>2</sub> ·6H <sub>2</sub> O | 29.8                  | 50.7 | -55             | +29.8 | 29.8                                      | 50.3 | CaCl <sub>2</sub> ·6H <sub>2</sub> O   |                           |                     |
| D    |                                      | 50.7                  | 60.6 | +29.8           |       |   |      | CaCl <sub>2</sub> ·6H <sub>2</sub> O<br>CaCl <sub>2</sub> ·4H <sub>2</sub> O |                           |                     |
| E    | CaCl <sub>2</sub> ·4H <sub>2</sub> O | 50.3                  | 60.6 | +29.8           | 45.3  | 50.3                                      | 56.6 | CaCl <sub>2</sub> ·4H <sub>2</sub> O   |                           |                     |
| F    |                                      | 60.6                  | 75.5 | 45.3            |       |   |      | CaCl <sub>2</sub> ·4H <sub>2</sub> O<br>CaCl <sub>2</sub> ·2H <sub>2</sub> O | 56.6                      | 45.3                |
| G    | CaCl <sub>2</sub> ·2H <sub>2</sub> O | 56.6                  | 75.5 | 45.3            | 175.5 | 56.6                                      | 74.9 | CaCl <sub>2</sub> ·2H <sub>2</sub> O   |                           |                     |
| H    |                                      | 75.5                  | 86.0 | 175.5           |       |   |      | CaCl <sub>2</sub> ·2H <sub>2</sub> O<br>CaCl <sub>2</sub> ·H <sub>2</sub> O  | 74.9                      | 175.5               |
| I    | CaCl <sub>2</sub> ·H <sub>2</sub> O  | 74.9                  | 86.0 | 175.5           | 260.0 | 74.9                                      | 86.0 | CaCl <sub>2</sub> ·H <sub>2</sub> O  |                           |                     |
| J    | Area above saturation curve          | unsaturated solutions |      |                 |       |   |      | none   |                           |                     |

Calcium chloride is highly soluble in water over a wide temperature range, with maximum solubility of approximately 75% at temperatures above 175 °C. Although calcium chloride dissolves readily in water to form highly concentrated solutions, due account must be taken of the temperature at which solid hydrates precipitate from these solutions. A detailed diagram of the solid and liquid phases, showing temperatures and concentrations of calcium chloride and water, is given in Figure 56.29. The solubility data in this diagram were obtained with pure calcium chloride. The saturation curve and the freezing points of solutions of commercial calcium chloride up to a concentration of 29.8% CaCl<sub>2</sub> are practically the same as for pure solutions; above 29.8% CaCl<sub>2</sub>, the curve follows the

same general pattern (and direction) but falls slightly to the left of the curve for pure calcium chloride. The difference in the curves is small between 29.8% and 50% CaCl<sub>2</sub> but increases somewhat at higher concentrations.

The effect of a small percentage of sodium chloride and other minor impurities is to raise the saturation temperature slightly for any given concentration of calcium chloride. Thus, a 40% CaCl<sub>2</sub> solution becomes saturated when cooled to ca. 13 °C, whereas a pure 40% CaCl<sub>2</sub> solution is saturated at ca. 12 °C.

Calcium chloride forms solutions with high densities. This property is commonly used to determine the strength of calcium chloride brines. Density data for commercial calcium chloride solutions are presented in Table 56.25.

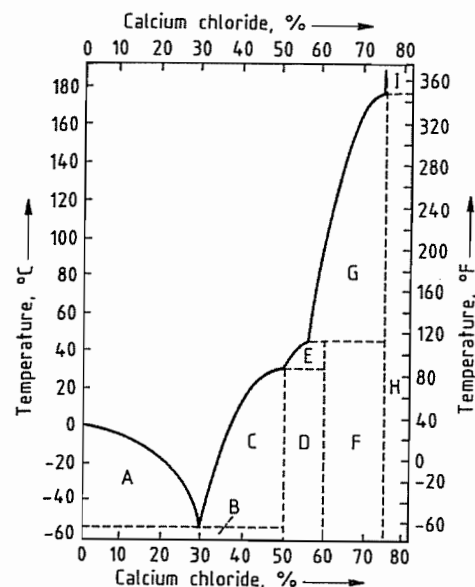
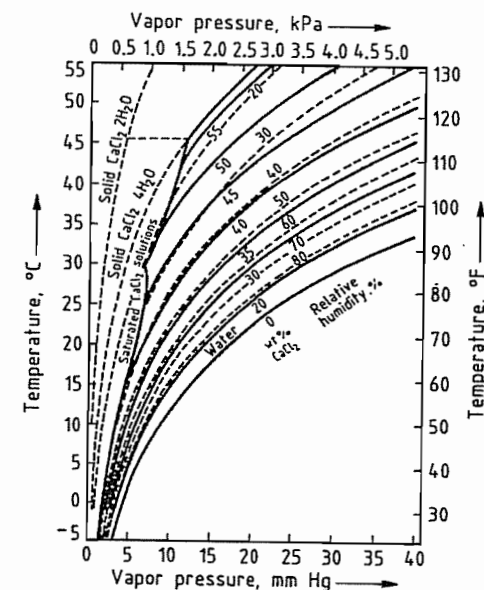

**Figure 56.29:** Solubility of pure calcium chloride in water-freezing point diagram (Courtesy Allied Corp.). Data for areas A-J given in Table 56.24.

**Table 56.25:** Densities and crystallizing temperatures of commercial calcium chloride solutions (Courtesy Allied Corp.).

| c <sub>CaCl<sub>2</sub></sub> , % | ρ (15.5 °C), g/cm <sup>3</sup> | Crystallizing temperature, °C |
|-----------------------------------|--------------------------------|-------------------------------|
| 0                                 | 0.999                          | 0                             |
| 2                                 | 1.017                          | -0.9                          |
| 4                                 | 1.033                          | -1.9                          |
| 6                                 | 1.051                          | -2.9                          |
| 8                                 | 1.068                          | -4.1                          |
| 10                                | 1.086                          | -5.4                          |
| 12                                | 1.104                          | -7.1                          |
| 14                                | 1.124                          | -9.2                          |
| 16                                | 1.144                          | -11.6                         |
| 18                                | 1.164                          | -14.5                         |
| 20                                | 1.185                          | -18.0                         |
| 25                                | 1.238                          | -29.4                         |
| 30                                | 1.294                          | -46.0                         |
| 35                                | 1.349                          | -9.8                          |
| 40                                | 1.409                          | +13.3                         |

Calcium chloride is extremely hygroscopic and deliquescent when the vapor pressure of the air equals or exceeds that of the saturated solution at the prevailing temperature. Data on calcium chloride solutions in equilibrium with air at various temperatures and relative humidities are presented in Figure 56.30.



**Figure 56.30:** Vapor pressure of calcium chloride solutions (Courtesy Allied Corp.).

Freshly prepared solutions of commercial calcium chloride are somewhat alkaline due to the presence of a small amount of lime (CaO). Although these solutions may exhibit a relatively high pH (pH ≤ 10.3), they have little acid-neutralizing value because of the small percentage of lime present.

Calcium chloride solutions exposed to air gradually absorb carbon dioxide to form calcium carbonate from the lime, thus reducing the pH of freshly prepared solutions [231, 233].

## 56.7.2 Chemical Properties

Calcium chloride is a source of soluble inorganic calcium and reacts with carbonates, fluorides, and sulfates to form insoluble or moderately soluble salts. Calcium chloride forms water soluble compounds with ammonia, e.g., CaCl<sub>2</sub>·8NH<sub>3</sub>, and with alcohol, e.g., CaCl<sub>2</sub>·C<sub>2</sub>H<sub>5</sub>OH. Calcium chloride reacts with sodium tungstate, Na<sub>2</sub>WO<sub>4</sub>, to form calcium tungstate, CaWO<sub>4</sub>, also known as synthetic scheelite [233-237].

Table 56.26: Calcium chloride standards.

|  | ASTM <sup>a</sup> D 98-80 |     |     | AASHTO <sup>b</sup> M 144-78 |     | Food Chemicals Codex <sup>c</sup> |       |
|--|---------------------------|-----|-----|------------------------------|-----|-----------------------------------|-------|
|  | 77%                       | 90% | 94% | 77%                          | 94% | 77%                               | 94%   |
| Calcium chloride, % min.                 | 77                        | 90  | 94  | 77                           | 94  | 74.7 to 80.8                      | 93    |
| Total alkali chlorides, % max. as NaCl   | 6.8                       | 8   | 8   | 2                            | 5   | —                                 | —     |
| Magnesium, % max. as MgCl <sub>2</sub>   | 0.43                      | 0.5 | 0.5 | 0.5                          | 0.5 | —                                 | —     |
| Magnesium and alkali salts, % max.       | —                         | —   | —   | —                            | —   | 4                                 | 5     |
| Other impurities excluding water, % max. | 0.85                      | 1   | 1   | 1                            | 1   | —                                 | —     |
| Arsenic, ppm max. as As                  | —                         | —   | —   | —                            | —   | 3                                 | 3     |
| Fluoride, % max. as F                    | —                         | —   | —   | —                            | —   | 0.004                             | 0.004 |
| Heavy metals, % max. as Pb               | —                         | —   | —   | —                            | —   | 0.02                              | 0.02  |
| Lead, ppm max. as Pb                     | —                         | —   | —   | —                            | —   | 10                                | 10    |

<sup>a</sup>American Society of Testing Materials specification is based on 90.5% calcium chloride; for comparison, the values shown have been adjusted and are on an "as received" basis.

<sup>b</sup>American Association of State Highway & Transportation Officials.

<sup>c</sup>Food Chemicals Codex actually specifies a range of 99–107% for calcium chloride dihydrate assay; for comparison, this range has been converted to actual calcium chloride content.

### 56.7.3 Production

Calcium chloride is produced in commercial quantities by several processes: (1) refining of natural brines, (2) the reaction of calcium hydroxide with ammonium chloride in Solvay (synthetic) soda ash production, and (3) the reaction of hydrochloric acid with calcium carbonate. The refining of natural brines and calcium chloride recovered from synthetic soda ash production together account for over 90% of calcium chloride production [232].

*Natural brines* in California and Michigan contain a mixture of chloride salts of calcium, magnesium, and sodium. Magnesium is removed by precipitating magnesium hydroxide, Mg(OH)<sub>2</sub>, with lime. The solution remaining after filtration is concentrated. Sodium chloride precipitates because it is only slightly soluble in calcium chloride solutions.

In the *ammonia-soda* (Solvay) process, ammonia serves as a catalyst for the reaction of sodium chloride with calcium carbonate. Although this process is actually quite complicated, it can be summarized as follows:

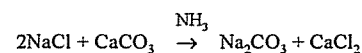

The calcium chloride solutions produced by the purification of natural brines and by the Solvay process are relatively dilute. Part of the solution is concentrated by evaporation to 30–45% calcium chloride and marketed as such.

An additional part is concentrated to ca. 75% solids, corresponding to calcium chloride dihydrate, CaCl<sub>2</sub>·2H<sub>2</sub>O. This material is flaked and dried to the commercial calcium chloride dihydrate (77–82% CaCl<sub>2</sub>) and anhydrous (94–97% CaCl<sub>2</sub>) products [238–240]. Anhydrous pellets can be produced by substituting an agglomeration procedure in place of the flaker [241, 242].

### 56.7.4 Environmental Protection

Calcium chloride is not generally considered harmful to the environment. However, as with any chemical, calcium chloride spills should be promptly contained and disposed of in accordance with local ordinances.

The taste threshold of calcium chloride in potable water is reported as 150–350 ppm. However, depending on the calcium hardness of the water, even concentrations as low as 50 ppm can be objectionable [243].

In high concentrations (> 1000 ppm), calcium chloride retards plant growth and can damage foliage. Because calcium is a nutrient for plants, these effects are most likely caused by accumulation of the chloride ion in the plant tissue. High chloride concentrations are seldom found in U.S. water supplies, even in areas of high salt usage for dust and ice control [243–245].

Calcium chloride concentrations of 10 000 to 20 000 ppm in water have been shown to be

hazardous to animals and fish because of differences in osmotic pressure. The effects vary from reduced growth rate and impaired reproduction to death. Such high concentrations are readily detected by the presence of an unpleasant saline taste. In general, the environmental effects of calcium chloride are quite similar to those of rock salt (sodium chloride) [243, 246].

### 56.7.5 Quality Specifications

The major uses of calcium chloride (ice and dust control) do not require high chemical purity. However, the calcium chloride must be free of materials that are harmful to the environment. Commercial calcium chloride from the three main processes contains low levels of heavy metals and organic compounds and is relatively innocuous.

The current standards established by various organizations are perhaps the best indication of calcium chloride quality (Table 56.26) [247–249].

Total alkali chlorides are generally the impurities of concern to calcium chloride producers. These impurities, essentially sodium chloride with smaller amounts of potassium chloride, are known to be harmful when included in cement. Because calcium chloride is utilized in cement, its total alkali chlorides content must be kept at a reasonable level.

In general, commercial calcium chloride meets the requirements of the Food Chemicals Codex. However, food-grade calcium chloride is not currently available from the major producers and is marketed regionally by companies that generally refine the commercial material. Because of the high quality of commercial calcium chloride, the FDA has granted variances covering some commercial grades of calcium chloride for use in vegetable brining and apple dipping. However, direct addition of commercial grades of calcium chloride to foods, such as cheese, continues to require food-grade material.

### 56.7.6 Chemical Analysis

Routine analytical tests performed on calcium chloride include: assay, total alkali chlorides, percent sodium chloride, percent potassium chloride, and various granulation tests [250–253].

The concentration of calcium chloride is most easily determined by an ethylenediaminetetraacetic acid (EDTA) titration. This procedure determines total calcium, which is expressed as calcium chloride. In the determination of total alkali chlorides, sodium chloride, and potassium chloride, atomic absorption spectroscopy is most widely used. Sodium and potassium are determined individually, and these results are combined and expressed as total alkali chlorides.

### 56.7.7 Storage and Transportation

Calcium chloride is not classified as a hazardous material by the DOT and is, therefore, not subject to specific handling regulations [254]. The various modes of transportation include: bulk rail cars (30–90 t), bulk trucks (up to 20 t), box rail cars, and van and flat-bed trailers. Depending on whether the shipments are in liquid or dry form, there are several variations to the above general classifications.

Dry bulk calcium chloride can be stored in bins fabricated from most construction-grade steel materials. Care should be taken to minimize moisture. Venting should be limited to times of filling and discharging calcium chloride from the storage bin. Liquid calcium chloride can be stored in either horizontal or vertical cylindrical tanks constructed of steel. Fiberglass and plastic may also be used within limits of strength and temperature.

Because calcium chloride is hygroscopic, the common safety precautions involved in the handling of chemicals should be observed: wearing gloves, boots, long-sleeve shirts, and safety glasses, and if dry products are being handled, dust protection must be insured.

### 56.7.8 Uses

Calcium chloride's versatility is related to its unique combination of physical properties: moisture attraction and retention, high solubility, high heat of solution, and freezing point depression of solutions. Calcium chloride is most widely known for its deicing and dust-controlling abilities.

The largest market for calcium chloride (30% of total production) is for *deicing* of roads, sidewalks, and parking lots (Table 56.27). Calcium chloride melts ice at temperatures as low as  $-51\text{ }^{\circ}\text{C}$  ( $-60\text{ }^{\circ}\text{F}$ ). Because it liberates heat when exposed to moisture, ice is melted quickly, usually within 15–30 min of application. Calcium chloride is also used in conjunction with rock salt (sodium chloride) to enhance and sustain the effectiveness of the rock salt.

**Table 56.27:** Calcium chloride end uses in the United States.

|  | %  |
|--|----|
| Deicing                                      | 30 |
| Dust control, road stabilization             | 25 |
| Industrial (refrigerant, coal thawing, etc.) | 15 |
| Oil and gas drilling fluids                  | 10 |
| Concrete                                     | 5  |
| Tire ballast                                 | 4  |
| Miscellaneous                                | 11 |

*Dust control* accounts for ca. 25% of calcium chloride production. Its hygroscopic and deliquescent properties make it ideal for this use. Calcium chloride absorbs moisture from the air and forms a solution that acts to coat dust particles and bind them together, greatly reducing dusting. Calcium chloride solutions are slow to evaporate because of their low vapor pressure and are, therefore, useful in the compaction of road surfaces.

Calcium chloride is used in the *cement* and *concrete* industries. Addition of 1–2% calcium chloride accelerates the setting time of concrete, resulting in earlier strength development. Calcium chloride should not be considered as an antifreeze in concreting; however, the addition of calcium chloride to concrete mixes poured at temperatures below  $21\text{ }^{\circ}\text{C}$

( $70\text{ }^{\circ}\text{F}$ ) largely offsets the retarding effects of the lower temperatures [255].

Calcium chloride solutions, because of their low freezing points, are used extensively as heat-transfer media in *food processing*. Calcium chloride brine greatly increases the heat-transfer rate compared to chilled air or to a sodium chloride brine. Contact time between the brine and the various food molds is decreased, resulting in higher production rates [256].

Calcium chloride is also used in the food industry to increase the firmness of fruits and vegetables and to prevent spoilage during processing.

In the *petroleum* and *petrochemical industries* calcium chloride is used as a desiccant for hydrocarbons. It is also used in drilling fluids, packer fluids, completion fluids, and workover fluids in oil well drilling.

*Other uses* for calcium chloride include:

|   |   |
|---|---|
| Adhesives                               | humectant<br>lowers gel temperature   |
| Animal feed supplement                  | source of calcium   |
| Tractor tire weight                     | lowers freezing temperature of water<br>improves traction by increasing tire weight |
| Highway shoulder and base stabilization | retains moisture which improves compaction of soils                                 |
| Freezeproofing of coal                  | lowers freezing point of residual water   |
| Paper manufacture                       | increases web strength of corrugated media  |
| Rubber manufacture                      | coagulates latex emulsions  |
| Steel and pig iron manufacture          | eliminates alkalis that attack furnace refractory                                   |
| Wastewater treatment                    | precipitates fluorides<br>breaks oil emulsions<br>densifies floc                    |

**Table 56.28:** World calcium chloride production from the Solvay process (1979).

| Continent     | Production (100% basis), $10^3\text{ t}$ |
|---------------|--|
| Europe*       | 15 480                                   |
| Asia          | 3 390                                    |
| North America | 1 460                                    |
| Australia     | 290                                      |
| South America | 210                                      |
| Africa        | 10                                       |
| Total         | 20 840                                   |

\*Includes the USSR.

**Table 56.29:** United States calcium chloride producers (1983).

| Producer          | Capacity (100% basis), $10^3\text{ t}$ |
|-------------------|--|
| Allied            | 263                                    |
| Dow               | 900                                    |
| Hill Brothers     | 4                                      |
| Leslie Salt       | 27                                     |
| National Chloride | 13                                     |
| Occidental        | 6                                      |
| Reichhold         | 6                                      |
| Texas United      | 32                                     |
| Wilkinson Salt    | 15                                     |
| Total             | 1266                                   |

### 56.7.9 Economic Aspects

The majority of the world's calcium chloride is a by-product from synthetic (Solvay) soda ash production. About 1 t of calcium chloride (anhydrous basis) is produced with each ton of synthetic soda ash. Synthetic soda ash production worldwide was ca.  $20.8 \times 10^6\text{ t}$  (1979), and a similar quantity of calcium chloride was also produced. However, most of this material is produced as a 5–10% waste solution and is simply discarded. World production of calcium chloride (waste and refined) from the Solvay process is shown by continent in Table 56.28 [257].

In the United States, synthetic soda ash has been largely replaced by natural material from Sweetwater County, Wyoming. As a result, natural brines now account for ca. 70% of the U.S. calcium chloride production. The major calcium chloride producers and their capacities are shown in Table 56.29.

Because of the widespread use of calcium chloride in deicing and dust control, demand for this chemical is erratic (demand, 100% basis, 1000 t):

| Year   | 1975 | 1979 | 1980 | 1981 | 1982 |
|--------|------|------|------|------|------|
| Demand | 550  | 690  | 550  | 670  | 590  |

Demand is expected to grow at a rate of 3% per year through 1986 [232, 258].

### 56.7.10 Toxicology and Occupational Health

Calcium chloride is not generally considered toxic; however, prolonged exposure may

be detrimental to health. Contact with skin may cause irritation. Calcium chloride can irritate or burn eyes. Inhalation of product dust may irritate nose, throat, or lungs. Ingestion could irritate the mouth, esophagus, or stomach. In rats calcium chloride has an acute oral  $\text{LD}_{50}$  of 1 g/kg. No TLV or MAK has been established for calcium chloride in air [259].

## 56.8 Calcium Cyanamide

Calcium cyanamide was probably first obtained in the laboratory in 1877 by heating calcium carbamate to red heat [268]. In 1889 it was prepared in larger quantities by heating thoroughly mixed, finely pulverized urea and calcium oxide [269]. A commercial process for the nitrogenation of calcium carbide, the Frank-Caro process, was patented in Germany in 1895 [270]. A calcium cyanamide plant using a batch oven furnace was erected at Piano d'Orta, Italy, in 1905. At about the same time, the Polzeniusz-Krauss channel furnace was put into service. By 1910, plants were established in Germany (Bayerische Kalkstickstoffwerke; AG für Stickstoffdünger), France, Japan, Sweden, Switzerland, and the United States (Amer. Cyanamid).

Calcium cyanamide,  $\text{CaNC}\equiv\text{N}$ , is the neutral salt of cyanamide,  $\text{NH}_2\text{CN}$ ; it is also known as lime nitrogen, nitrolime, and kalkstickstoff.

Industrial-grade calcium cyanamide contains, in addition to  $\text{CaCN}_2$ , ca. 20%  $\text{CaO}$  and 10–12% free carbon, which gives the product its gray-black color. It also contains a small amount of nitrides formed from silica and alumina. The total nitrogen content varies from 22 to 25%, depending on the raw materials used. Of the total nitrogen, 92–95% is present as cyanamide and 0.1–0.4% as dicyandiamide; the remainder is present as nitrides.

### 56.8.1 Physical Properties [270]

Pure calcium cyanamide is a colorless hygroscopic salt, which forms rhombohedral crystals. In a nitrogen atmosphere, it melts

with decomposition at 1300 °C. Other physical properties are given below.

|   |   |
|---|---|
| Density at 25 °C                          | 2.36 g/cm <sup>3</sup>                  |
| Heat of fusion                            | 54 kJ/kg                                |
| Specific heat, 20–100 °C                  | 909 J/kg                                |
| Enthalpy of formation $\Delta H_{298}$    | -348 kJ/mol                             |
| Free energy of formation $\Delta F_{298}$ | -303 kJ/mol                             |
| Normal entropy $S$                        | 87.1 Jmol <sup>-1</sup> K <sup>-1</sup> |

## 56.8.2 Chemical Properties [271]

Calcium cyanamide decomposes above 1000 °C in a way that depends on the temperature, the partial pressure of nitrogen, and impurities present. The principal decomposition products formed by heating under vacuum or in an inert gas are calcium carbide, calcium metal, and nitrogen:



Decomposition at higher nitrogen pressure gives primarily cyanide products. Calcium nitride and carbon are always formed.

Calcium cyanamide reacts with oxygen and carbon dioxide, starting at ca. 475 °C, with formation of nitrogen and calcium carbonate, calcium oxide forms above 850–900 °C. Carbon present as an impurity cannot be removed by oxidation, which attacks calcium cyanamide preferentially.

Carbon monoxide and calcium cyanamide react above 1000 °C to form CaO and calcium carbide.

The reactions of calcium cyanamide in aqueous solution are determined primarily by temperature and pH [272]. At room temperature, monocalcium cyanamide, Ca(HCN<sub>2</sub>)<sub>2</sub> forms; when heated at pH 9–10, this is converted to calcium hydroxide and dicyandiamide, (NH<sub>2</sub>)<sub>2</sub>CNCN. Below 40 °C, cyanamide is obtained at pH 6–8; lime is precipitated with carbon dioxide.

Urea forms in the presence of acid and catalysts, thiourea in the presence of sulfides.

At 200 °C under pressure, calcium cyanamide is hydrolyzed to ammonia and calcium carbonate in an alkaline medium. The reaction was employed to produce ammonia early in this century.

## 56.8.3 Production

### 56.8.3.1 Overall Process

Calcium cyanamide is manufactured in three steps. First, lime is made by heating high-grade limestone:

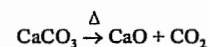

Second, calcium carbide is synthesized from lime and coke or coal in an electric furnace:

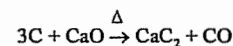

A smothered electric arc is used to melt the lime and effect the reaction with the coke.

Third, calcium cyanamide is synthesized from calcium carbide and nitrogen. This reaction is exothermic but requires heating of a portion of the reaction mixture to the initiation temperature of 900–1000 °C:

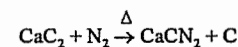

The heat source is then removed [272]. The reaction continues by controlled addition of nitrogen; it produces 286.6 kJ/mol at 1100 °C and 295 kJ/mol at 0 °C.

**Mechanism.** It is believed that calcium cyanamide is formed through a number of intermediates, such as Ca(CN)<sub>2</sub>, CaC<sub>2</sub>N<sub>2</sub>, CaC, and Ca<sub>2</sub>N<sub>2</sub> [273–275]. However, in the nitrogenation of calcium carbide, the main products are calcium cyanamide and carbon. Above 1000 °C, cyanide also forms and is in equilibrium with cyanamide and carbon:

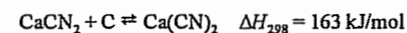

This reaction is endothermic, whereas the nitrogenation is exothermic.

Above 1160 °C, the system CaCN<sub>2</sub>/C/Ca(CN)<sub>2</sub> melts, with over 60% cyanamide present at equilibrium.

Small amounts of cyanide present at the usual reaction temperatures of 1000–1100 °C are rapidly converted to calcium cyanamide by slow cooling; the cooled product is practically free of cyanide.

When the cyanide-containing melt is cooled in the presence of alkali-metal compounds, complete conversion to cyanamide does not take place. This is the basis of the fusion cyanide process, which is still used at the present time. Commercially, cyanide (ca. 50% NaCN equivalent) is prepared by melting and cooling a mixture of calcium cyanamide and sodium chloride [276]; the product is used mainly for precious metal extraction.

**Nitrogenation By-products.** Technical-grade calcium carbide contains impurities that, during nitrogenation, lower the yield of desired product. This is due to the fact that silica and alumina, which are only partially reduced in the carbide furnace, are present in the carbide raw materials. In the nitrogenation, Al<sub>2</sub>O<sub>3</sub> and SiO<sub>2</sub> react with CaCN<sub>2</sub> to form nitrides.

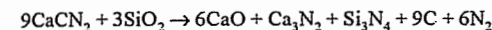
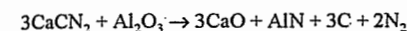

Industrial-grade calcium carbide also contains calcium hydroxide, Ca(OH)<sub>2</sub>, and calcium carbonate, CaCO<sub>3</sub>. On heating, water and carbon dioxide are liberated; reaction with carbide gives acetylene. As a result, hydrogen, formed by decomposition of acetylene, is always found in the exhaust gas of the nitrogenation furnaces.

These side reactions and the inadvertent introduction of some oxygen during the nitrogenation reduce the overall yield by ca. 10%. The purest possible raw materials give the most favorable results economically.

**Catalysts.** Various catalysts that act as fluxes are used to accelerate the reaction or lower the required temperature. The most commonly used are calcium chloride and calcium fluoride. Their function is not completely clear, but they may provide a liquid phase in which the reaction can occur. The product is in the form of a well-sintered pig, indicating the presence of a liquid phase at some stage of the reaction.

Rate studies have shown that calcium fluoride reduces the temperature of optimum reac-

tivity and increases the reaction rate 4.5 times at 1000 °C [277].

**Reaction Kinetics.** The conversion rate depends on temperature, partial nitrogen pressure, carbide purity, and additives present. The crystallite size also plays a part. High-grade carbide with a coarse crystal structure reacts more slowly than fine material of a lower grade. As indicated above, metal halides accelerate the reaction.

In the nitrogenation of calcium carbide, the reaction proceeds inward from the grain surface. The rate of nitrogen transport through the porous layer is a determining factor at lower temperature, whereas the chemical reaction at the boundary layer governs at higher temperature and in the presence of additives. The dependence of the rate constants on temperature, additives, and nitrogen pressure has been reported [278]. Figure 56.31 shows the effect of nitrogen pressure.

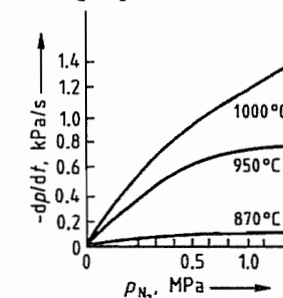

Figure 56.31: Rate of calcium carbide nitrogenation as a function of nitrogen pressure [278]. Powdered CaC<sub>2</sub> (67%) containing 1.2% CaF<sub>2</sub> used.

### 56.8.3.2 Manufacture

Both batch and continuous processes have been used to prepare calcium cyanamide [287]. The more important processes include the Frank-Caro batch furnace process, the Polzeniusz-Krauss channel furnace process, the Trostberg rotary furnace process, and the Fujiyama shaft furnace process. Other processes have been explored, but have not achieved comparable importance.

In these processes, the exothermal reaction between carbide and nitrogen takes place between 1000 and 1150 °C. In the continuous ro-

tary furnace process, the reactants, except at the beginning, are heated exclusively by the heat of reaction, whereas the batch furnace process requires ignition for each batch.

All processes use finely ground high-grade calcium carbide and control of the reaction temperature by the addition of lime nitrogen (crude calcium cyanamide). This dilution of the carbide prevents a temperature rise that would decompose the cyanamide and promotes homogeneity and nitrogen diffusion. This type of temperature control is of particular importance in the Trostberg rotary furnace process to prevent caking on the furnace wall.

**Frank-Caro Batch Oven Process** [277]. The batch oven process is widely used in North America. It employs a batch reactor filled with ground calcium carbide. After an initial ignition, the reaction proceeds spontaneously. Large stationary furnaces with and without basket inserts have been used in several variations. A basket insert with a capacity up to 10 t is filled with ground carbide and inserted into a steel furnace equipped with nitrogen inlets and a current supply. Graphite heating rods (up to 3.5 m long) are inserted into the carbide, and contact is established with the cover and grounded furnace shell. Before application of the electrical charge, nitrogen is introduced through inlets in the lower part of the furnace shell. When the walls of the channels glow after being heated for 3–4 h, the current is turned off and the reaction is allowed to go to completion. After being initiated, the exothermic reaction is self-sustaining.

During the reaction, the contents sinter to a block or pig. In an 8–10-t furnace, the reaction is completed and the mixture partially cooled in ca. 70 h. Although calcium cyanamide is white, the pig is black because of graphite formed during the reaction. It contains ca. 70% calcium cyanamide, 10% free lime, 12% graphite, and 0.5% unreacted carbide. The pig is broken into pieces and milled.

**Furnaces and Electrodes.** The batch oven furnaces used in North America by Amer. Cyanamid are cylindrical, firebrick-lined steel shells (Figure 56.32). The firebrick floor of

the furnace (20 cm is adequate) is covered with carbon blocks cemented with pitch. This refractory material withstands the high temperature and alkalinity of the molten lime. The sides of the furnaces are not subjected to vigorous conditions because they are insulated by a mass of charge and product. The external dimensions of a typical large furnace are 12.5 × 13.8 m at the top, 8.8 × 3.3 m at the bottom, and a height of 5.5 m [277].

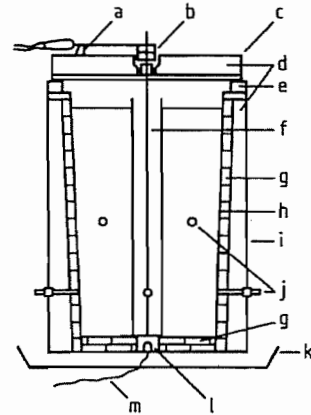

Figure 56.32: Self-heating nitrogenation oven: a) Insulator; b) Graphite contact; c) Steel cover; d) Diatomaceous earth; e) Sand seal; f) Graphite rod; g) Firebrick; h) Paper lining; i) Steel shell; j) Nitrogen inlets and outlets; k) Sand tray; l) Graphite ground contact; m) Ground lead.

A number of electrode systems have been used in batch furnaces. In one system the electrodes are equipped with one to three composite rectangular rods made of electrolytic-grade carbon held in a line to give a composite cross-section of 510 × 280 cm when all are used. Another system uses sliding contacts, permitting the addition of electrode components without removing the assembly from the furnace. Component electrodes have also been replaced with continuous electrodes of the Söderberg type, where a paste of carbonized anthracite, coke fines, and tar is packed into the top of a 12.2-m thin steel tube. The tube serves as an electrode and is fed into the furnace as it burns away from the bottom. As the paste moves closer to the surface of the charge, it is slowly baked, conferring great mechanical strength when it reaches the 2-m

section below the sliding electrical contacts [277].

**Polzeniusz-Krauss Channel Furnace Process.** In the channel furnace process, the carbide mixture is diluted with lime nitrogen (ca. 67% carbide solids) and 2–3% calcium chloride or fluorspar. This mixture is loaded into iron boxes of ca. 1800 kg capacity and rolled into the channel furnace by a rail assembly. The furnace is 50–80 m long and can be closed by gastight doors made of brickwork in the reaction zone and of sheet metal muffles in the cooling zone (Figure 56.33). A significant advantage of the channel furnace is its flexibility of operation, which can be modified, depending on the quality of the carbide, the duration of the reaction, and the temperature of the cooling zone. To accelerate ignition at 750 °C, a small amount of calcium nitrate is added.

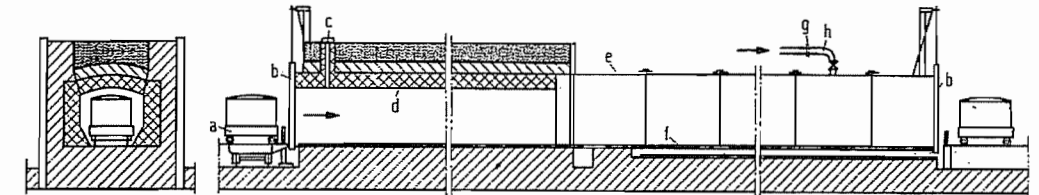

Figure 56.33: Channel furnace: a) Cast steel carriage; b) Doors; c) Temperature measuring connection; d) Refractory walls; e) Sheet metal muffler; f) Rails; g) Orifice gauge; h) Nitrogen inlet tube.

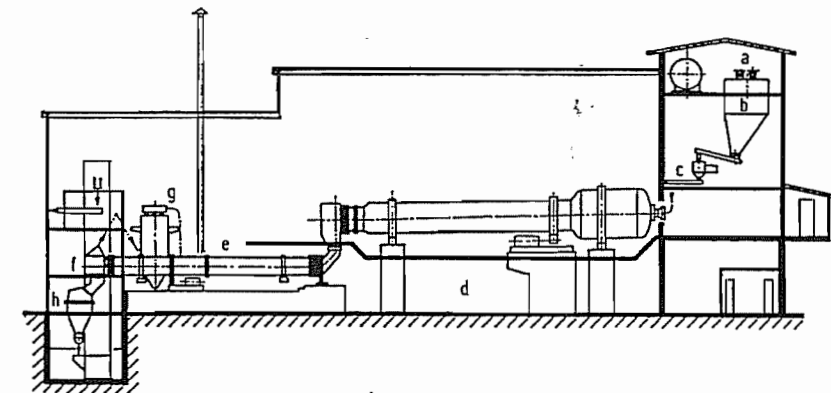

Figure 56.34: Trostberg rotary furnace: a) Feed; b) Silo for ground material; c) Metering; d) Reaction section; e) Cooling unit; f) Discharge; g) Filter; h) Hammer mill.

Ground carbide with a  $\text{CaC}_2$  content of 55–60% is continuously mixed with calcium fluoride and ground lime nitrogen and is blown into the furnace with nitrogen. The average residence time of the solid is between 5 and 6 h. The resultant reaction product is a granular or powdered lime nitrogen, which is transferred from the rotary furnace to a cooling drum. The heat released by the reaction is sufficient to bring the starting materials to the desired temperature of 1000–1100 °C. After the furnace has been started, it remains in operation without external heating for many months. The capacity of a unit is about 25 t/d of fixed nitrogen. For the manufacture of calcium cyanamide, crude calcium carbide (ca.  $3.36 \times 1.68$  mm or  $6 \times 12$  mesh) can be used; for cyanamide and dicyandiamide a 74- $\mu\text{m}$  (200-mesh) anhydrous carbide is used.

**Knapsack Rotary Furnace Process** [280]. The Knapsack rotary kiln process was developed 20 years before the Trostberg process, but has not been in operation at Knapsack since 1971. It is the only industrial process that does not use finely ground calcium carbide and that operates without dilution with lime nitrogen. Granular carbide, up to 2 mm in diameter, is nitrogenated in the presence of 1–2% of calcium chloride in a cylindrical rotary drum, giving a product of the same grain size as the starting carbide. A typical kiln can produce 12–13 t/d of fixed nitrogen; the product can be sold without further processing.

**Fujiyama Process.** This Japanese process employs a shaft furnace equipped with a continuous charging unit for ground carbide and a scraping device at the lower end of the furnace where the calcium cyanamide is formed.

**Carlson Process.** This fluidized-bed process, operated in a furnace with stirrers, was used for a few years in Sweden. It failed because of the tendency of the reaction material to agglomerate [281]. A combination of this approach with a rotary furnace was explored, but was not adapted commercially [282].

**Other Processes.** Because large amounts of energy are consumed, particularly in the prep-

aration of calcium carbide, less energy intensive methods for manufacturing calcium cyanamide have been examined. Between 600 and ca. 1000 °C many reactions of lime with nitrogen compounds containing hydrogen or carbon lead to calcium cyanamide. Compounds such as hydrocyanic acid, dicyanogen, urea, and dicyandiamide form calcium cyanamide with lime. Another example is the reaction of limestone with ammonia [283]:

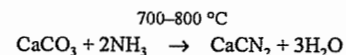

Lime and urea form calcium cyanate [284, 285], which on heating is converted to calcium cyanurate and finally to calcium cyanamide:

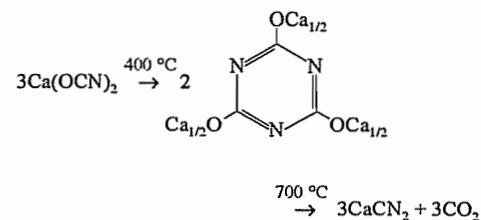
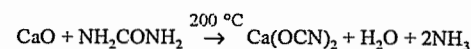

Lime reacts with hydrogen cyanide [286]:

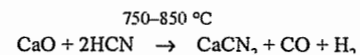

An ammonia–carbon monoxide mixture produces 99% calcium cyanamide:

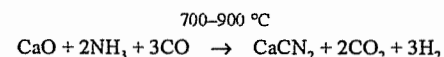

The above processes give white calcium cyanamide, whereas the product obtained from limestone and coal always contains carbonaceous impurities. None of these processes have yet been commercialized because of cost or poor yield [287].

### 56.8.3.3 Processing of Technical Calcium Cyanamide

Crude calcium cyanamide is reduced in size and ground in tube mills to allow passage through a 0.2-mm screen. If calcium cyana-

mid is sold in granular form, grinding is omitted and the desired grain size is separated by screening.

When the carbide content is above 0.1%, as in the Frank–Caro process, calcium cyanamide is degassed by treatment with water to convert the carbide to acetylene and calcium hydroxide. For safety reasons, the acetylene is dispersed with an inert gas [277].

**Granulation.** Because of the dust problems associated with finely ground calcium cyanamide in fertilizer applications, the product is oiled. Attempts have also been made to convert it to a more compact form by granulation or compression. A stable, abrasion-resistant granular material is produced by a two-stage process, in which ground calcium cyanamide is initially treated with a small amount of water or an aqueous solution to hydrate any free calcium oxide. In the second stage, the material is moistened, granulated, and dried or pressed [288].

**Beads.** Granulation with calcium nitrate solutions gives a fine, finished calcium cyanamide bead. This form affords a nitrate nitrogen system that can be used directly in the plant as starter nitrogen. In addition, it affords a slowly acting cyanamide nitrogen source [289]. This product has an almost unlimited storage life, because the free calcium oxide is completely hydrated and no expansion can occur. In Europe, the Trostberg plant of Süddeutsche Kalkstickstoff-Werke is the main producer of beaded calcium cyanamide.

**Encapsulation of Granular Calcium Cyanamide.** Various coating methods have been used to protect crushed granular calcium cyanamide against decomposition. Waxes and resins have been investigated, but only sulfur is used in practice [289]. It functions by limiting the diffusion of water into the material, and it permits fertilizing action in use.

### 56.8.4 Quality Specifications

Commercial-grade calcium cyanamide has approximately the following composition:

|                |        |
|----------------|--------|
| Total nitrogen | 19–20% |
|----------------|--------|

|                          |          |
|--------------------------|----------|
| Cyanamide nitrogen       | ca. 15%  |
| Nitrate nitrogen         | ca. 2%   |
| Dicyandiamide nitrogen   | 0.4–0.7% |
| Other nitrogen           | 2.0–2.5% |
| Total calcium oxide      | 53–55%   |
| Water (chemically bound) | 7–8%     |

Total nitrogen is determined by the Kjeldahl or Dumas method.

### 56.8.5 Storage and Transportation

Calcium cyanamide is stored in warehouses or silos, but storage life with free calcium oxide is limited because the latter is expanded by moisture.

Production-grade ground calcium cyanamide, with a nitrogen content of 22–24%, is adjusted to the usual commercial nitrogen content of 19–20% by adding a diluent such as ground limestone. Oiling may be used to prevent dusting.

Valve bags are used almost exclusively for packaging. Bags used for ground and granular calcium cyanamide must be moisture-tight to prevent grain breakdown and expansion. Polyethylene valve bags in combination with multilayer paper bags are excellent for granular calcium cyanamide. Paper and plastic bags are used for the less sensitive, beaded product. Loose beaded calcium cyanamide may be transported in special containers in Germany. For agricultural applications, 50-kg bags are used; smaller packages of finely beaded product are sold for horticultural applications.

### 56.8.6 Uses

In Europe, cyanamide and calcium cyanamide are used as fertilizers, weed killers, and defoliants. In North America these applications have been practically discontinued. In fertilizer applications, calcium cyanamide is broken down by soil moisture into highly reactive lime and free cyanamide; the latter is converted by soil microbes to urea and then ultimately to ammonia. Nitrifying bacteria convert ammonia to nitrate [290]. Calcium cyanamide is particularly valuable for acid soils in need of lime. It can also be used in mixed fertilizers, although if it is used in excess, the resultant high alkalinity reduces solu-

ble phosphate. Calcium cyanamide is used on asparagus and onions as a weed killer. Heavy applications approximately 1 month before planting control soil-borne plant disease and weed seed.

Calcium cyanamide has been used to control animal pests. On grasslands it is used to kill the dwarf water snail, the intermediate host of the liver fluke. It also kills gastric and intestinal parasites in domestic animals and destroys salmonellæ in liquid sewage.

Nitrogen oxides are removed from waste gases with over 99% efficiency by scrubbing with calcium cyanamide [291]. In portland cement, cyanamide and calcium cyanamide improve set characteristics, increase compression strength, and reduce freeze-thaw damage [292].

Pharmaceutical-grade calcium cyanamide is used to treat alcoholism. A small pill, taken once a day, subjects the alcohol user to an unpleasant cyanamide flush (see Section 56.8.5), which discourages drinking [293]. Calcium cyanamide is used for steel nitridation [294] and, to some extent, for desulfurization [295]. It has various uses in the production of cyanamide, dicyandiamide, melamine and other substituted triazines, thiourea, and guanidines.

## 56.9 References

1. *Metals Handbook*, 9th ed., vol. 1. American Society for Metals, Metals Park, OH, 1978.
2. J. W. Robison: "Ladle and Mold Treatments with Steel-Clad Metallic Calcium Wire", *Scaninject III*, MEFOS, Lulea, Sweden, 1983, pp. 35.1-35.23.
3. D. C. Brown: "High Quality Strand Cast Steel", *33 Metal Producing 1982* (Sept.) 62-66.
4. R. D. Prengaman: *Advanced Lead Alloys for Maintenance-Free Batteries*, Lead Development Assoc., London, England, 1980.
5. S. E. Hluchan: *Calcium Alloys for Battery Grid Production*, Lead Development Assoc., London, England, 1983.
6. R. S. Boynton: *Chemistry and Technology of Lime and Limestone*, John Wiley, New York 1980.
7. ASTM C-207 Specification for Hydrated Lime for Masonry Purposes, American Society for Sampling and Testing.
8. J. Murray: "Specific Heat Data for Evaluation of Lime Kiln Performance", *Rock Prod.*, Aug. 1947, 148.
9. H. Bäckström, *J. Am. Chem. Soc.* 47 (1925) 2432, 2443.
10. Cem. Bureau, World Statistical View, 1988.
11. Schumacker, *J. Am. Chem. Soc.* 48 (1926) 396.
12. BS 6463: Quicklime, Hydrated Lime and Natural Calcium Carbonate.
13. DIN 1060: Building Limes, 1982.
14. ASTM C 110: Methods of Physical Testing of Quicklime, Hydrated Lime and Limestone.
15. N. E. Rogers, *Cem. Lime Gravel*, June 1970, 149-153.
16. A. B. Searle: *Limestone and Its Products*, E. Benn, London 1935.
17. M. O'Driscoll, *Ind. Miner.*, May 1988, 23-51.
18. A. Jackson: *Oxygen Steelmaking for Steelmakers*, Butterworths, London 1969.
19. ASTM C911: Specification for Quicklime, Hydrated Lime and Limestone for Chemical Uses.
20. Specification for Highway Works, Part 2, Aug. 1986, HMSO.
21. International Critical Tables, 5, McGraw Hill, New York 1929, pp. 98-99.
22. R. Haslam et al., *J. Am. Chem. Soc.* 46 (1924) 308.
23. A. Seidell: *Solubilities of Inorganic and Metal Organic Compounds*, Van Nostrand, Princeton 1965, pp. 309-310.
24. N. Knibbs, *Lime and Magnesia*, E. Benn, London 1924, p. 71.
25. AWWA Standard B 202-83 American National Standards Institute.
26. D. H. Stowe, Lime for F. G. D., 6th International Lime Congress, 1986, International Lime Association.
27. BS 890 (1972): Specification for Building Limes.
28. Notes on Best Practicable Means Requirements for Mineral Works, BPM 13, Health and Safety Executive, Department of Environment, London.
29. Notes of Best Practicable Means Requirements for Lime Works, BPM 2/78, Health and Safety Executive, Department of Environment, London.
30. ASTM D 75: Methods for Sampling Aggregates.
31. ASTM C 50: Sampling, Inspection, Packing and Marketing of Lime and Limestone Products.
32. BS 812 (1975): Testing Aggregate, Parts 1, 2 & 3.
33. BS 1017 (1977): Methods for Sampling of Coal and Coke, Part 1.
34. BS 822 (1983): Specification for Aggregates from Natural Sources for Concrete.
35. BS 63 (1987): Road Aggregates.
36. P. G. Roe, D. C. Webster, Road Research Laboratory, Scientific Report, 829, HMSO, London 1984.
37. BS 4987 (1988): Coated Macadam for Roads and Other Paved Areas.
38. ASTM C-25: Method for Chemical Analysis of Limestone, Quicklime and Hydrated Lime.
39. *Quicklime—Delivery, Storage and Handling*, TS/E/37/3, ICI Chemicals and Polymers Ltd., Buxton 1986.
40. Hydrated Lime—Delivery, Storage and Handling, TS/E/34/3, ICI Chemicals and Polymers Ltd., Buxton 1987.
41. Minerals Yearbook, 1987, U.S. Bureau of Mines, Washington.
42. U. K. Business Monitor, PA 1007, 1986, HMSO.
43. Occupational Exposure Limits, Health and Safety Executive, Guidance Note EH 40/96, HSE Books.
44. Health and Safety Commission and Health and Safety Executive Reports from 1985/6 and 1986/7 and IISF, "Quarries" Report for 1984/5, HMSO.
45. "Safety in Quarries" (Part 1), J. M. Hobbs, 1988, Private Publication.
46. Health and Safety Executive Report "Mines" 1985/6, HMSO.
47. N. G. Grice, personal communication, Jan. 1990.
48. DD ENV 459-1, 1995, *Building Lime*.
49. EN 998 TC 164 (in preparation), *Test Methods for Calcium Carbonate, High-Calcium Lime, and Half-burnt Dolomite used for Treatment of Water for Human Consumption*.
50. BS 6463, Part 102 (in preparation), *Methods for Chemical Analysis of Quicklime, Hydrated Lime, and Natural Calcium Carbonate*.
51. *Statistical Year Book*, 1995, British Aggregate Construction Mineral Industries.
52. *International Lime Association—Statistics*, 1994.
53. *European Minerals Yearbook*, 1994.
54. EN 998, *Specification for Mortars for Masonry*.
55. H. E. Schwiete, A. N. Knauf: *Gips—Alte und neue Erkenntnisse in der Herstellung und Anwendung der Gipse*, Merziger Druckerei u. Verlags-GmbH, Merzig 1969.
56. *Winnacker-Kitchler*, 4th ed., vol. 3, pp. 262-277.
57. A. Voellmy, W. Albrecht: "Die Prüfung der Gipse und Gipsmörtel", in O. Graf (ed.): *Handbuch der Werkstoffprüfung*, 2nd ed., vol. 3, Springer Verlag, Berlin 1957, pp. 520-576.
58. *Gmelin*, system no. 28, Calcium, Main B3 (1961), pp. 675-785.
59. A. W. Groves: *Gypsum and Anhydrite, Overseas Geological Surveys*, Her Majesty's Stationery Office, London 1958.
60. F. Lotze: *Steinsalz und Kalisalze, Geologie. Die wichtigsten Lagerstätten der „Nichterze“*, 2nd ed., 1st part, Verlag Gebr. Bornträger, Berlin 1957.
61. A. V. Slack: *Phosphoric Acid*, Marcel Dekker, New York 1968, parts I, II.
62. M. Sekiya: *Gypsum*, K. K. Gihodo, Tokyo 1964.
63. K. Volkart: *Bauen mit Gips*, Bundesverband der Gips- u. Gipsbauplatten-Industrie, Darmstadt 1981.
64. Gips-Datenbuch, Bundesverband der Gips- und Gipsbauplattenindustrie, 1995.
65. W. Albrecht: *Stuckgips und Putzgips, Fortschritte und Forschungen im Bauwesen*, no. 15, Franckh'sche Verlagshandlung, Stuttgart 1953.
66. A. V. Volzenskij, A. V. Ferronskaja: *Gips, Bindemittel und Erzeugnisse (Technologie, Eigenschaften, Anwendung)*, Strojizdat, Moscow 1974.
67. S. D. Ewjentschik, A. A. Novikow, *Phosphogips und seine Anwendung*, Moskow "Chimija" 1990.
68. *Die Strahlenexposition von außen in der Bundesrepublik Deutschland durch natürliche radioaktive Stoffe im Freien und in Wohnungen unter Berücksichtigung des Einflusses von Baustoffen*, Der Bundesminister des Innern, Bonn 1978.
69. G. Franz: *Dentalgipse*, Hanser Verlag, München-Wien 1981.
70. H. Hanusch: *Gipskartonplatten Trockenbau-Montagebau-Ausbau*, Verlagsgesellschaft Rudolf Müller, Köln-Braunsfeld 1978.
71. G. Beard: *Stuck—Die Entwicklung plastischer Dekoration*, Schuler Verlagsgesellschaft, Herrsching 1983.
72. M. Murat, M. Foucault: "Sulfates de calcium et matériaux dérivés," *Colloques internationaux de la RILEM*, Paris 1977.
73. R. M. Gruver, *J. Am. Ceram. Soc.* 34 (1951) 353-357.
74. E. Eipeltauer, *Zem. Kalk Gips* 11 (1958) 264-272, 304-316.
75. W. C. Riddell, *Rock Prod.* 53 (1950) 68-71, 102.
76. H. Lehmann, K. Rieke, *Tonind. Ztg. Keram. Rundsch.* 97 (1973) 157-159.
77. S. M. Mehta: *Dissertation*, Techn. Universität, Clausthal 1974.
78. K. Reisdorf, W. Abriel, *Neues Jahrbuch Miner. Abh.* 157 (1987) 35-46.
79. W. Abriel, K. Reisdorf, J. Parmetier, *J. Solid State Chem.* 85 (1990) 23-30.
80. C. Bezou, A. Nonat, J.-C. Mutin, A. Nørlund Christensen, M. S. Lehmann, *J. Solid State Chem.* 117 (1995) 165-176.
81. B. F. Pedersen, D. Semmingsen, *Acta Crystallogr.* B38 (1982) 1074-1077.
82. A. Kirfel, G. Will, *Acta Crystallogr.* B36, (1980) 2881-2890.
83. G. C. H. Cheng, J. Zussman, *Acta Crystallogr.* 16 (1963) 767-769.
84. F. Wirsching, R. Hüller, B. Kimmer, *Zem. Kalk Gips* 47 (1994) 278-286.
85. K. K. Kelley, J. C. Southard, C. T. Anderson: *U. S. Bur. Mines Tech. Paper* 625 (1941).
86. A. Krus, H. Späth, *Tonind. Ztg. Keram. Rundsch.* 75 (1951) 341-351, 395-399.
87. H. J. Kuzel, M. Hauner, *Zem. Kalk Gips* 40 (1987) 628-632.
88. Nippon Kokan Kabushiki, GB 1016007, 1962 (K. Araki).
89. H. J. Förster, *Chem. Ing. Tech.* 44 (1972) 969-972.
90. D. Kitchen, W. J. Skinner, *J. Appl. Chem. Biotechnol.* 21 (1971) 53-55, 56-60, 65-67.
91. E. Eipeltauer, *Tonind. Ztg. Keram. Rundsch.* 97 (1973) 4-8.
92. U. Ludwig, *Zem. Kalk Gips* 21 (1968) 81-90, 109-119, 175-180.
93. S. Sprung, *Zem. Kalk Gips* 27 (1974) 259-267.
94. G. Leifeld, W. Münchberg, W. Stegmaier, *Zem. Kalk Gips* 23 (1970) 174-177.
95. D. Hass, E. Kemnitz, B. Grunze, R. Sebowski, H. Worzala, *Z. anorg. allg. Chem.* 525 (1985) 173-178.
96. H. Borchert, E. Baier, *Neues Jahrb. Mineral. Abh.* 86 (1953) 103-154.
97. E. Posnjak, *Am. J. Sci.* 238 (1940) 559-568.
98. A. Herrmann, *Silik. J.* 3 (1964) 443-466.
99. D. Ostwald, *Tonind. Ztg. Keram. Rundsch.* 78 (1954) 137-142, 173-177.
100. F. Wirsching, R. Hüller, D. Olejnik, *Zem. Kalk Gips* 47 (1994) 65-69, 683-688.
101. H. Hamm, *Zem. Kalk Gips* 47 (1994) 443-451.
102. J. Beckert, H. J. Einbrodt, M. Fischer, Bericht und gutachterliche Stellungnahme zu FGD gypsum and natural gypsum, VGB-Forschungsförderung, Bundesverband der Gips- und Gipsbauplattenindustrie Darmstadt (1990).



103. Proceedings from the 4th International Conference on FGD and Synthetic Gypsum, Ortech Corporation, Mississauga, Ontario, Canada.
104. W. Kumpf, K. Maas, H. Straub: *Handbuch Müll- und Abfallbeseitigung: Rückstände aus der Phosphorsäureproduktion*, vol. 5, E. Schmidt Verlag, Berlin 1964, no. 8581 (1982).
105. Official Journal of the European Communities L5/22, Vol. 37, 7 January 1994.
106. Official Journal of the European Communities L288/36-46, Vol. 37, 9 November 1994.
107. E. Eipeltauer, S. Stojadinovic, *Ber. Dtsch. Keram Ges.* 37 (1960) 442-447.
108. J. R. Gunn, *Gypsum J.* 49 (1968) 14-18.
109. W. Kreuter, *Zem. Kalk Gips* 27 (1974) 222-225.
110. P. Joest, *Ind. Steine Erden* 71 (1961) 23-29; *Glückauf* 92 (1956) 504-506.
111. DIN 1168, Gypsum building plasters (1975).
112. BPB Ind., DE 1258321, 1962 (R. C. Blair).
113. A. J. T. Ward, *Zem. Kalk Gips Ed. B* 33 (1980) 594-600.
114. W. Lahl, H. E. Schwiete, *Zem. Kalk Gips* 12 (1959) 345-351, 582.
115. J. Steinkuhl, O. Wiechmann, K. Moldan, *Zem. Kalk Gips* 25 (1972) 383-386.
116. E. Eipeltauer, Ch. Stein, *Zem. Kalk Gips* 52 (1963) 45-53.
117. P. Sörgel, J. Bergmann, G. Fietsch, *Silikattechnik* 22 (1971) 225-230.
118. National Gypsum Co., US 2788960, 1954 (S. D. Skinner).
119. Gebrüder Knauf, DE 1143430, 1961 (A. N. Knauf).
120. H. Hamm, F. Wirsching, *Zem. Kalk Gips* 27 (1974) 226-229.
121. P. Landrieu, J. Gibaru, C. Collomb, *Zem. Kalk Gips* 17 (1964) 455-460.
122. D. Roddewig: "Erfahrungen beim Brennen von Gips im Kompaktrohren", *15th Eurogypsum Congress*, Venice, Sept. 1982.
123. Roddewig & Co., CH 445359, 1964 (H. Roddewig, sen.).
124. D. Böcker, H. Kreusing, *Zem. Kalk Gips Ed. B* 34 (1981) 221-226.
125. H. Remmen, M. Grünwald, G. Hilsdar, *Zem. Kalk Gips* 42 (1989) 217-222.
126. H. Jurkowitzsch, R. Hüller, *Zem. Kalk Gips* 43 (1990) 583-588.
127. H. Scholze, M. Hurbanic, Conradt, *Zem. Kalk Gips* 42 (1989) 248-251.
128. F. Wirsching, *Umwelt* 13, 435-438.
129. H. Hamm, *Zem. Kalk Gips* 44 (1991) 593-604.
130. A. Kurandt, *ISMA Tech. Conf.* 1974.
131. Fisons, GB 1135951, 1966 (N. Robinson).
132. Nissan Kakasu KKK, US 3653826, 1968 (T. Ishihara).
133. Société de Prayon, DE 1567821, 1966 (E. Pavonet).
134. "Getting Rid of Phosphogypsum I-IV", *Phosphorus Potassium* 87 (1977) 37; 89 (1977) 36; 94 (1978) 24; 96 (1978) 30.
135. *International Symposium on Phosphogypsum*, 5-7 Nov. 1980, Florida Institute of Phosphate Research (47 Papers).
136. J. Beretka, T. Brown, *J. Chem. Technol. Biotechnol.* 32 (1982) 607-613, 33A (1983) 299-308.
137. "Supply-Demand Trend of Gypsum, Lime and Cement in 1994", *Inorganic Materials* 2 (1995) no. 258, 426-438.
138. D. Israel, *ZKG International* 49 (1996) 228-234.
139. K. Schaupp, K. Metz, *Zentralbl. Industriebau* 4 (1965) 180-184.
140. M. H. Le Chatelier, *C. R. Hebd. Séances Acad. Sci.* 96 (1883) 1668-1671.
141. J. H. Van't Hoff, E. F. Armstrong, W. Hinrichsen, F. Weigert, G. Just, *Z. Phys. Chem. Stoechiom. Verwandtschaftsl.* 45 (1903) 257-306.
142. J. R. Clifton, *Report NBS-TN 755* (1973) 1-28.
143. M. J. Ridge, J. Beretka, *Rev. Pure Appl. Chem.* 19 (1969) 17-44.
144. W. Krönert, P. Haubert, *Zem. Kalk Gips* 25 (1972) 553-558.
145. A. Cavazzi, *Z. Chem. Ind. Kolloide* 12 (1913) 196-201.
146. M. Baykoff, *C. R. Hebd. Séances Acad. Sci.* 182 (1926) 128-129.
147. K.W. Fischer, *Wiss. Z. Hochsch. Arch. Bauwes. Weimar* 10 (1963) 351-371.
148. W. Krönert, P. Haubert, unpublished results, RWTH Aachen.
149. U. Ludwig, J. Kuhlmann, *Tonind. Ztg. Keram. Rundsch.* 98 (1974) 1-4.
150. H. Lehmann, H. Mathiak, P. Kurpiers, *Ber. Deutsch. Keram. Ges.* 50 (1973) 201-204.
151. M. K. Lane, *Rock Prod.* 71 (1968) no. 3, 60-63, 108; no. 4, 73-75, 116, 117.
152. R. A. Kuntze, *Mater. Res. Stand.* 7 (1967) 350-353.
153. Certain-Teed Products Corp., US 2067762, 1934 (G. A. Hoggatt).
154. B. Lelong, *Zem. Kalk Gips Ed. B* 37 (1984) 205-218.
155. Gebrüder Knauf, DE-AS 2023853, 1970 (A.N. Knauf).
156. A. Aignesberger, H. Krieger, *Zem.* 21 (1968) 415-419.
157. Imperial Chem. Ind., GB 1049184, 1963 (K. G. Cunningham).
158. Imperial Chem. Ind., DE 1126792, 1959 (K. G. Cunningham).
159. G. Benz, *Stuckgewerbe* 1969, no. 12, 533-544.
160. A. N. Knauf, W. Krönert, P. Haubert, *Zem. Kalk Gips* 25 (1972) 546-552.
161. T. Kosłowski, U. Ludwig: *Zitronensäure*, Institut für Gesteinshüttenkunde der RWTH, Aachen (1983).
162. K. Aichinger, B. Wandser, *Zem. Kalk Gips* 1 (1948) 33-37, 50-51.
163. H. Engelke, *Zem. Kalk Gips* 32 (1979) 560-568.
164. M. Rößler, *Dissertation*, Techn. Universität, Clausthal 1983.
165. B. Wandser, *Zem. Kalk Gips* 15 (1962) 437-438.
166. M. J. Ridge, H. Surkevicius, *J. Appl. Chem.* 11 (1961) 420-434.
167. M. Murat, *Tonind. Ztg. Keram. Rundsch.* 97 (1973) 160-164; 98 (1974) 33-37, 73-78.
168. G. Neuhauser, *Bundesbaublatt* 31 (1982) 566-569.
169. E. Aeppli, *Eurogypsum*, Stockholm 1972.
170. N. W. Knauf, DE 1104419, 1957 (A. N. Knauf).
171. FERMA Gesellschaft für Rationelle Fertigbaumethoden und Maschinenanlagen mbH & Co., CH 505674, 1969 (K. Schäfer).

172. M. A. Ali, F. J. Grimer, *J. Mater. Sci.* 4 (1969) 389-395.
173. J. Kazimir, *Tonind. Ztg. Keram. Rundsch.* 91 (1967) 22-25.
174. G. Kossatz, K. Lempfer, *Holz Roh. Werkst.* 40 (1982) 333-337.
175. G. Kossatz, *Baustoffindustrie* 9 (1966) 1-5.
176. A. N. Knauf, *Stuckgewerbe* 1961, no. 3, 1-4.
177. Forschungsgemeinschaft Bauen und Wohnen: *Estriche im Hochbau*, no. 80, Verlagsgesellschaft R. Müller, Köln-Braunsfeld 1966.
178. F. Henrich, *Glückauf* 107 (1971) 1-13; *Neue Bergbautech.* 9 (1979) 409.
179. P. Thien, *Glückauf* 128 (1992) 750-757.
180. DIN 1164, Portland-, Eisenportland-, Hochofen und Träszement (1978).
181. H. E. Schwiete, U. Ludwig, P. Jäger, *Zem. Kalk Gips* 17 (1964) 229-236.
182. T. Matyszewski, G. Ambrozewicz, *Baustoffindustrie, Ausg. A* 16 (1973) no. 5, 18-20.
183. Stroitelnykh i Njerudnykh Materialow, DE 1241330, 1963 (P. W. Lapschin).
184. W. Reingen, *Zem. Kalk Gips* 27 (1974) 252-258.
185. J. C. Rinehart, G. R. Blake, J. C. F. Tedrow, F. E. Bear, *Bull. N.J. Agric. Exp. Stn.* 772 (1953).
186. "The WSZ Schwefelsäure und Zement GmbH - Unique or a Model for the Future?" *ZKG International* 49 (1996) A33-A34.
187. F. Wirsching, E. Weißflag, *VGB Kraftwerkstechnik* 68 (1988) 1131-1141; 1269-1278.
188. E. Sacher, *ISMA Tech. Conf.* 1968.
189. F. Wirsching, R. Hüller, H. Hamm, H. Hoffmann, A. Pützer, *ZKG International* 48 (1995) 241-256.
190. H. Hamm, K. Kraft, J. Trummer, F. Wirsching, *Wochenblatt für Papierfabrikation* 123 (1995) 88-94.
191. Franklin Key, Inc., US 3822340, 1974 (J. J. Eberl).
192. H. Scholze, M. Hurbanic, H. Engelke, *Zem. Kalk Gips Ed. B* 34 (1981) 318-338.
193. H. Scholze, *Tonind. Fachber.* 108 (1984) 170-172.
194. H. Haagen, *Farbe Lack* 87 (1981) 543-550.
195. F. Wirsching, *ZKG International* 44 (1991) 248-252.
196. D. Schumann, *Bauwirtschaft* 26 (1972) 88-97.
197. Ch. Collomb, *Zem. Kalk Gips* 17 (1964) 451-454.
198. DIN 4208, Anhydrite binder (1984).
199. DIN 18163, Gypsum partition panels (1978).
200. DIN 18169, Gypsum ceiling panels (Draft 1979).
201. DIN 18180, Gypsum plasterboards (1978).
202. DIN 4102, Behaviour of building materials and components in fire (Parts 1 + 4, 1981; Parts 2 + 3, 1977; Parts 5-7, 1977; Part 8, Draft 1977).
203. DIN 4103, Non-loadbearing partitions (Part 1, Draft 1982; Part 2, Draft 1983).
204. DIN 4108, Thermal insulation in buildings (1981).
205. DIN 4109, Noise-control in buildings (1962).
206. DIN 18168, Light ceiling linings and underceilings (Part 1, 1981; Part 2, Draft 1982).
207. DIN 18181, Gypsum plasterboards for building construction (1969).
208. DIN 18182, Accessories for the use of gypsum plasterboards (Part 1, Draft 1983; Parts 2-4 in preparation).
209. DIN 18183, Lightweight partitions of gypsum plasterboards (Draft 1975).
210. DIN 18184, Gypsum plaster sandwich boards (1981).
211. DIN 18350, Plaster and stucco works (1979).
212. DIN 18550, Plaster and rendering (Parts 1 + 2, Draft 1979).
213. DIN 18555, Testing of mortars with mineral binders (Parts 1-3, 1982; Part 4, Draft 1983; Part 5 in preparation).
214. DIN 18560, Floor screeds in building construction (Parts 1-5, Draft 1983).
215. DIN 13911, Dental materials; gypsum; requirements, testing (1976).
216. L. Chassevart, *Zem. Kalk Gips* 15 (1962) 509-512.
217. F. Wihwing, W. Poch, *Zem. Kalk Gips* 27 (1974) 240-244.
218. Wissenschaftlich-Technische Kommission von Eurogypsum, *Tonind. Ztg. Keram. Rundsch.* 97 (1973) 145-157.
219. K. Litzow: *Handbuch der Keramik, Gruppe VA*, 7, Verlag Schmid, Freiburg i. Brg. 1969.
220. G. Neuhauser, *Zem. Kalk Gips* 27 (1974) 240-244.
221. H. Lehmann, *Tonind. Ztg. Keram. Rundsch.* 91 (1967) 8-14.
222. *Ullmann*, 4th ed., vol. 12, p. 312.
223. Phasenanalyse von Gips, Forschungsvereinigung der Gipsindustrie e.V., Darmstadt (1988).
224. R. A. Kuntze, *Mater. Res. Stand.* 2 (1962) 640-642.
225. V. Schlichenmaier, *Tonind. Ztg. Keram. Rundsch.* 98 (1974) 223.
226. A. Mielsds, *Intern. Cem. Review* Nov 1992, 20-29; Nov. 1995, 31-32.
227. J. C. Bailar, H. J. Emeleus, R. Nyholm, A. F. Trotman Dickenson (ed.): *Comprehensive Inorganic Chemistry*, 1st ed., vol. 1, Pergamon Press, Oxford 1973, pp. 630-633.
228. C. Palache, H. Berman, C. Frondel: *The System of Mineralogy*, 7th ed., vol. 2, J. Wiley & Sons, New York 1951, pp. 91-96.
229. G. E. Dunning, J. F. Cooper, Jr., *Am. Mineral.* 54 (1969) 1018-1025.
230. J. F. Thorpe, M. A. Whiteley: *Thorpe's Dictionary of Applied Chemistry*, 4th ed., vol. 2, Longmans, Green & Co., New York 1938, pp. 212-214.
231. "Calcium Chloride", *Technical and Engineering Service Bulletin* No. 16, Allied Corp., Morristown, NJ, 1978.
232. "Calcium Chloride", *Chemical Products Synopsis*, Mansville Chemical Products, Mansville, NY, June, 1983.
233. National Research Council: *International Critical Tables*, McGraw-Hill, New York 1928.
234. G. F. Hüttig, *Z. Anorg. Allg. Chem.* 123 (1922) 31-42; *Chem. Abstr.* 16 (1922) 4153.
235. W. H. Nebergall, F. C. Schmidt, H. F. Holtzclaw, Jr.: *College Chemistry with Qualitative Analysis*, 2nd ed., D. C. Heath & Co., Boston 1963, pp. 654-655.
236. H. Stephen, T. Stephen (ed.): *Solubilities of Inorganic and Organic Compounds*, vol. 1, Macmillan Publ. Co., New York 1963, Part 1, pp. 243-261.
237. D. J. Treskon: "Tungsten", *Chemical Economics Handbook*, Stanford Research Institute, Menlo Park, CA, 1977, Section 789.1000-789.1001 M.
238. T.-P. Hou: *Manufacture of Soda With Special Reference to the Ammonia Process*, 2nd ed., Reinhold Publ. Co., New York 1942, pp. 252-253.

239. Solvay Process Co., CA 314878, 1927 (C. Sundstrom).
240. Dow Chemical Co., US 1660053, 1928 (A. K. Smith).
241. Dow Chemical Co., US 2646343, 1953 (W. R. Bennett, L. N. Carmouche).
242. Dow Chemical Co., US 4076776, 1978 (W. G. Moore).
243. J. E. McKee, H. W. Wolf (eds.): *Water Quality Criteria*, 2nd ed., The Resources Agency of California State Water Quality Control Board, Publication No. 3-A, pp. 152-153.
244. F. W. Holmes, J. H. Baker: "Salt Injury to Trees", II. Sodium and Chloride in Roadside Sugar Maples in Massachusetts", *Phytopathology* 56 (June, 1966) no. 6, 633-636 (reprint).
245. F. E. Hutchinson: *The Influence of Salts Applied to Highways on the Levels of Sodium and Chloride Ions Present in Water and Soil Samples*, U.S. Department of the Interior, Project No. A-007-ME, U.S. Gov't. Printing Office, Washington, DC, June, 1969.
246. "Primary Skin Irritation Test-Rabbits", Hazelton Laboratories, Inc., March 1963, unpublished paper.
247. R. P. Lukens, J. L. Cornillot, R. A. Prieman, D. J. Felty et al.: *Annual Book of ASTM Standards*, ASTM, Philadelphia 1981, Part 14, pp. 183-186.
248. American Association of State Highway and Transportation Officials, *Standard Specification for Calcium Chloride: M144-78*, AASHTO, Washington, DC, 1978.
249. National Research Council: *Food Chemicals Codex*, 3rd ed., National Academy Press, Washington, DC, 1981, pp. 47-49.
250. Allied Corp., Assay of Calcium Chloride, CA 4-12A, revised June, 1983.
251. Allied Corp., Determination of Sodium and Potassium in Calcium Chloride, CA 4-56, June, 1983.
252. Reference [247], Part 30, pp. 1041-1046.
253. Reference [247], Part 35, pp. 644-647.
254. General Services Administration: "Transportation", Title 49 Code of Federal Regulations, U.S. Gov't. Printing Office, Washington, DC, 1982, Part 172.
255. National Ready Mixed Concrete Association: *Cold Weather Ready Mixed Concrete*, Silver Spring, MD, 1968, pp. 11-12.
256. ASHRAE *Handbook 1981 Fundamentals*, American Society of Heating, Refrigerating, and Air Conditioning Engineers, Inc., Atlanta, GA, 1981, pp. 18.2-18.5.
257. *The Economics of Soda Ash*, 1st ed., Roskill Information Services Ltd., London 1981, pp. 20-26.
258. "Calcium Chloride", *Chemical Profiles*, Schnell Publishing Co., New York, April, 1982.
259. N. I. Sax: *Dangerous Properties of Industrial Materials*, 5th ed., Van Nostrand Reinhold Co., New York 1979, pp. 460-461.
260. M. Wildhagen: *Handbook of Industrial Electrochemistry*, vol. 5, Akademie-Verlag, Leipzig 1953, Part 1.
261. A. Brauer, J. D'Ans: *Progress in Industrial Chemistry*, Springer, Berlin 1937.
262. "SKW-Cyanamide Products", Südd. Kalkstickstoff-Werke, Trostberg, Germany, 1973, 82 pp.
263. "Cyanamide", Amer. Cyanamid, Wayne, NJ, 1966, 49 pp.
264. *Beil.* 3, 91; 3(2), 42; 3(2), 75; 3(3), 167.
265. "Dicyandiamide", Südd. Kalkstickstoff-Werke, Germany, 1973.
266. "Aero Dicyandiamide", Amer. Cyanamid, Wayne NJ, 1970, 20 pp.
267. E. Drechsel, *J. Prakt. Chem.* 16 (1877) 180-200.
268. F. Emich, *Monatsh. Chem.* 10 (1889) 321-352.
269. N. Caro, A. Frank, DE 88363, 1895.
270. *Gmelin*, system no. 28, Calcium, Parts B1-2 (1956) pp. 179-195.
271. *Gmelin*, system no. 14, Carbon, Part D1 (1971) pp. 258-297.
272. *Gmelin*, system no. 28, Calcium, Part B3 (1961) pp. 962-971.
273. T. Aono, *Bull. Chem. Soc. Jpn.* 16 (1941) 92-98.
274. V. Ehrlich, *Z. Elektrochem.* 32 (1926) 187-188.
275. F. E. Polzeniusz, *Chem. Ztg.* 31 (1907) 958.
276. H. H. Frank, H. Heimann, *Z. Elektrochem.* 33 (1927) 469-475.
277. M. L. Kastens, W. G. McBurney, *Ind. Eng. Chem.* 43 (1951) 1020-1033.
278. H. Rock, *Chem. Ztg. Chem. Appar.* 88 (1964) 191-271.
279. Südd. Kalkstickstoff-Werke, DE 917543, 1952 (F. Kaess et al.).
280. Südd. Kalkstickstoff-Werke, US 2838379, 1958 (F. Kaess et al.).
281. BASF, DE 965992, 1950 (G. Hamprecht, H. Gettert).
282. Südd. Kalkstickstoff-Werke, DE 972048, 1953 (T. Fischer et al.).
283. A. A. Pimenova et al., *Tr. Tashk. Politekh. Inst.* 107 (1973) 49.
284. Amer. Cyanamid, unpublished results.
285. V. G. Golov et al., *Tr. N.-I i Proekt. In-Ta Azot. Prom.-Sti i Produktov Organ. Sinteza* 28 (1974) 49-52; *Chem. Abstr.* 84 (1975) 159006n.
286. "Cyanamide by Cyanamid", Amer. Cyanamid, Wayne, NJ, 1961.  
O. I. Polyanshikov et al., *Vopr. Khim. Tekhnol.* 39 (1975) 136.
287. *Gmelin*, system no. 28, Calcium, Part B1-2 1956-1957, pp. 179-196.
288. Ferto Chemical Sales Co., DE 623600, 1932.
289. Südd. Kalkstickstoff-Werke, DE 1097457, 1961 (T. Fischer et al.).
290. K. Rathsack, *Landwirtsch. Forsch.* 6 (Special ed.) (1954) 116-132.
291. Nukem, DE 2926107, 1981 (H. Qui Umann).
292. Amer. Cyanamid, US 3503766, 1970 (F. De Maria).  
R. E. Dwyer, US 4049465, 1977.
293. K. Arikawa, K. Inanaga, *Folia Psychiat. Neurol. Jpn.* 27 (1973) no. 1, 9.
294. Goerig Co., DE 1771827, 1973 (P. Birk, K. Wohlge-muth).  
K. Deutzmann, DE 2136450, 1973 (W. Blank O. Vorbach).
295. Südd. Kalkstickstoff Werke, DE 2252795, DE 2252796, 1974 (W. Meichsner).

## 57 Strontium

PAUL MACMILLAN (§§ 57.1, 57.2, 57.7); ROLF GERSTENBERG, KARL KÖHLER, JAI WON PARK, HEINZ WAGNER, PETER WALL-BRECHT (§§ 57.3-57.6, 57.8)

|                            |      |                           |      |
|----------------------------|------|---------------------------|------|
| 57.1 Introduction          | 2329 | 57.6.2 Strontium Nitrate  | 2332 |
| 57.2 Properties            | 2329 | 57.6.3 Strontium Chloride | 2333 |
| 57.3 Occurrence            | 2330 | 57.6.4 Strontium Chromate | 2333 |
| 57.4 Mining and Processing | 2330 | 57.7 Strontium Metal      | 2333 |
| 57.5 Digestion of Ores     | 2331 | 57.8 Toxicology           | 2335 |
| 57.6 Inorganic Compounds   | 2331 | 57.9 References           | 2335 |
| 57.6.1 Strontium Carbonate | 2331 |                           |      |

### 57.1 Introduction

Strontium belongs to group 2 of the periodic table and is one of the alkaline earth metals. Strontium, with atomic number 38, lies between calcium and barium in this group. Strontium was first discovered by A. CRAWFORD in 1790. The discovery of strontium carbonate, which was originally thought to be barium carbonate, is associated with a lead mine located in Strontian, Scotland, hence the name strontium. In 1791 T. C. HOPE confirmed CRAWFORD's discovery, distinguishing strontium carbonate from calcium and barium carbonates.

In 1808 H. DAVY [8] produced strontium metal from strontium carbonate originating from the Strontian deposit. DAVY produced an oxide from the carbonate, and electrolyzed a mixture thereof with mercuric oxide to produce a strontium amalgam.

### 57.2 Properties

Strontium metal is silvery white and lustrous, but it readily forms a white surface coating when exposed to air and water. Strontium is allotropic and displays three crystal structures; at temperatures below 215 °C it is face-centered cubic. The crystal system properties are summarized in Table 57.1. Some other properties are listed below:

Atomic number 38

|                               |        |
|-------------------------------|--------|
| Atomic mass                   | 87.62  |
| Stable isotopes               |        |
| <sup>84</sup> Sr              | 0.56%  |
| <sup>86</sup> Sr              | 9.96%  |
| <sup>87</sup> Sr              | 7.02%  |
| <sup>88</sup> Sr              | 82.56% |
| Density, g/cm <sup>3</sup>    | 2.63   |
| Melting point, °C             | 768    |
| Boiling point, °C             | 1381   |
| Heat of fusion, kJ/kg         | 104.7  |
| Electrical resistivity, μΩ/cm | 22.76  |

Table 57.1: Strontium crystal structures.

| Temperature, °C | Structure | Atomic radius, pm | Lattice constants, pm |     |
|-----------------|-----------|-------------------|-----------------------|-----|
|                 |           |                   | a                     | c   |
| < 215           | fcc       | 213               | 607                   |     |
| 215-605         | hcp       | 202               | 431                   | 705 |
| > 605           | bcc       | 195               | 484                   |     |

Strontium is generally more reactive than magnesium and calcium and less reactive than barium. Strontium reacts with H<sub>2</sub>O, O<sub>2</sub>, N<sub>2</sub>, F<sub>2</sub>, and S producing compounds which correspond to its valence of two.

Common practice for the analysis of strontium is based on the use of spectral emissions. Strontium and strontium compounds impart a bright crimson color to a flame. Some of the lines useful in the quantitative analysis of strontium are listed below (wavelength in nm):

|                   |              |
|-------------------|--------------|
| Arc spectra       | 460.7, 421.6 |
| Spark spectra     | 407.8, 421.6 |
| Flame photometry  | 460.7, 407.8 |
| Atomic absorption | 460.7, 407.8 |

Strontium, while less reactive than the alkali metals, is a strong reducing agent and requires appropriate handling. Strontium reacts

vigorously with water to form SrOH, liberating H<sub>2</sub> in the process.

### 57.3 Occurrence

Strontium is present in the earth's crust at an average concentration of 0.04%, and is therefore 15th in abundance. In seawater it is the 10th most abundant element, having a concentration of 0.0008% [9].

Of the naturally occurring strontium compounds, only the minerals strontianite (strontium carbonate, SrCO<sub>3</sub>) and celestite (strontium sulfate, SrSO<sub>4</sub>) are of economic importance.

Celestite can be formed as a direct precipitate in a series of marine salt deposits. Hydrothermal formation is also possible [10]. In addition, it seems possible that strontium sulfate could be formed by modification of primary strontium-bearing minerals (aragonite, calcite, anhydrite), whereby part of the strontium included in the crystal lattice is liberated and then precipitated as celestite by sulfate-containing solutions [11]. Strontianite can be formed both as a primary mineral from the hydrothermal phase and as a secondary mineral from, e.g., celestite [12].

Celestite occurs principally as nodules, lenses, beds and materials filling crevices in sedimentary rocks such as carbonates, gypsums, clays, and evaporites. The economic importance of celestite is considerably greater than that of strontianite.

Very large, exploited deposits occur in Spain, Mexico, Turkey, China, and Iran. There are much less important deposits in Algeria, Cyprus, Argentina, and Morocco. Mining in the United Kingdom, the traditional producer, ended in 1992. Little is yet known of the deposits and their extraction in the former eastern bloc [13, 14].

### 57.4 Mining and Processing

Celestite ores are obtained by both open-cast and underground mining. In most cases, only coarsely intergrown rich ores are worked,

which can be further enriched by hand picking to give a material containing > 90% SrSO<sub>4</sub>. Demands for increasing purity in chemically produced strontium salts together with the growth of mechanized mining techniques necessitate a continually increasing amount of processing.

Finely divided impurities are removed by desliming. By means of density separation, celestite ( $\rho = 3.8\text{--}3.9 \text{ g/cm}^3$ ) is separated from limestone, quartz, gypsum, and dolomite, which have densities of < 3 g/cm<sup>3</sup>, giving end products containing > 95% SrSO<sub>4</sub>. In Spain, a flotation plant for separating finely intergrown celestite ores has been in operation since 1990. The introduction of this technology has markedly increased the number of deposits worldwide that can be profitably worked.

Many important deposits cannot be mined because of unacceptably high levels of barium and deposit-specific trace elements that cannot be removed by available processing technologies.

**Economic Aspects.** Whereas strontianite was the principal starting material used in the production of strontium compounds between 1870 and 1920, it has now been almost completely replaced by celestite for this purpose.

Practically the only use for celestite is the production of other strontium compounds. It is used only to a small extent as a white filler in competition with ground barite (barium sulfate).

World production of celestite in the early 1990s was estimated at ca. 250 000–300 000 t/a. The most important producing countries, with their production figures, are listed in Table 57.2.

Table 57.2: Estimated production of celestite (10<sup>3</sup> t).

| Country        | 1988 | 1991 |
|----------------|------|------|
| Spain          | 45   | 70   |
| Turkey         | 55   | 65   |
| United Kingdom | 20   | 2    |
| China          | 20   | 25   |
| Mexico         | 40   | 90   |
| Iran           | 10   | 20   |
| Morocco        | 2    | 4    |

### 57.5 Digestion of Ores

**Reduction with Carbon.** Celestite, floated or ground to 0.1–1 mm, is chemically reduced according to the equation

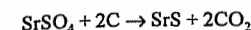

The reduction is carried out at 1100–1200 °C with coal in a rotary kiln, heated by fuel oil, natural gas, or coal dust in countercurrent flow. The conditions used depend in particular on the type of celestite and its impurities.

The light gray to grayish-black crude strontium sulfide (75–80% SrS) produced is extracted with hot water. The insoluble solids are removed in a series of thickeners. The solution obtained is generally used to produce strontium carbonate.

**Reaction with Sodium Carbonate.** Ground celestite (SrSO<sub>4</sub>) is converted to strontium carbonate by adding it to hot sodium carbonate solution. Numerous variations of this process have been proposed. Typically, an excess of Na<sub>2</sub>CO<sub>3</sub> solution is used. The crude product so obtained is not usually acceptable without further treatment. A product sufficiently pure for most applications is obtained by dissolving the crude material in hydrochloric acid, neutralizing with sodium carbonate solution to precipitate iron and aluminum, filtering, and reprecipitating with caustic soda. This process also produces impure sodium sulfate solution as a by-product which must be further treated or disposed of. The high consumption of sodium carbonate is a further drawback.

**Other Processes.** Celestite can be reacted with ammonium carbonate in a continuous countercurrent reactor to form strontium carbonate and ammonium sulfate [15]. The ammonium sulfate is treated with calcium oxide or calcium carbonate to form calcium sulfate, ammonia, and carbon dioxide, which are re-used for producing ammonium carbonate.

In the Odda process for producing orthophosphoric acid, phosphate rock is reacted with nitric acid. The strontium present in many types of phosphate rock is converted to strontium nitrate, which remains in the insoluble

residues if the concentrations of HNO<sub>3</sub> and Ca(NO<sub>3</sub>)<sub>2</sub> are kept within certain limits. It can then be recovered by extraction with water.

### 57.6 Inorganic Compounds

Like the compounds of the other alkaline earth metals, the strontium compounds are white or colorless. The sulfate and the carbonate are of low solubility, being intermediate between the corresponding compounds of calcium and barium in this respect.

Strontium compounds give a striking carmine red color to a flame. This property is used both for the rapid detection of strontium compounds and in pyrotechnics. Quantitative analysis of the industrial strontium compounds is usually carried out by means of titrimetry, X-ray fluorescence spectroscopy, and atomic absorption spectroscopy.

#### 57.6.1 Strontium Carbonate

Strontium carbonate, SrCO<sub>3</sub>,  $\rho 3.70 \text{ g/cm}^3$ , *mp* 1497 °C (6.99 MPa) forms rhombic crystals (aragonite type) below 924 °C, and hexagonal crystals (calcite type) above this temperature. Its solubility at 25 °C is 10<sup>-3</sup> g/100 mL. Strontium carbonate is produced from strontium sulfide, SrS.

**Precipitation by Carbon Dioxide.** Strontium carbonate is precipitated from the clarified solution of strontium sulfide with carbon dioxide. Strontium carbonate and hydrogen sulfide are formed.

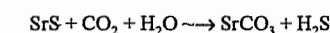

The carbon dioxide is obtained from natural wells or from industrial processes. The reaction is carried out in gas-tight reactors, and is so controlled that the hydrogen sulfide produced has a low CO<sub>2</sub> content. The hydrogen sulfide is converted to sulfur in a Claus plant.

**Precipitation with Sodium Carbonate.** Sodium carbonate can be used instead of carbon dioxide in the above reaction.

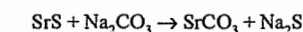

In addition to strontium carbonate, a dilute solution of sodium sulfide is formed, which is

concentrated to give a 60% solution; the solidified product is marketable.

The choice of production method depends on the comparative availabilities of carbon dioxide and sodium carbonate, and the opportunities for exploiting the by-products sulfur and sodium sulfide.

The two processes lead to products with different properties. The impurities in the strontium carbonate depend partly on the raw materials used. Also, the concentrations, temperatures, and reaction times lead to different values of bulk density, particle size distribution, and concentrations of sulfur and heavy metals.

The strontium carbonate powder is often converted into granules in a further process.

**Quality Specifications.** Typical specifications for strontium carbonate from the two precipitation processes are as follows:

|                                |             |
|--------------------------------|-------------|
| SrCO <sub>3</sub>              | 98.0–98.5%  |
| BaCO <sub>3</sub>              | 1.0–2.5%    |
| Sulfur (as SO <sub>3</sub> )   | 0.3–0.5%    |
| HCl insolubles                 | 0.1–0.6%    |
| Fe <sub>2</sub> O <sub>3</sub> | 0.005–0.01% |

*For powder:*

|                              |                           |
|------------------------------|---------------------------|
| Bulk density                 | 0.4–1.2 g/cm <sup>3</sup> |
| Fraction of particles < 3 μm | 95–100%                   |

*For granules:*

|                     |                           |
|---------------------|---------------------------|
| Bulk density        | 1.2–1.8 g/cm <sup>3</sup> |
| Grain size > 850 μm | 0–5%                      |
| < 150 μm            | 5–15%                     |

**Transport.** Strontium carbonate is stored in silos, and transported in 25 or 50 kg multi-ply paper sacks, 1 t big bags, or silo wagons. Strontium carbonate is not listed as a dangerous material in current regulations.

**Uses.** Strontium carbonate is by far the most important industrial compound of strontium. Its main use is in the manufacture of X-ray-absorbing glass for cathode ray tubes. Strontium carbonate is also used in the manufacture of ceramic permanent magnets (strontium ferrite), for removing lead from solutions of zinc sulfate in the electrolytic zinc process, and for the production of strontium metal, electrocer-

amics, and oxide superconductors [14, 16]. Strontium carbonate is also the starting material for the production of other strontium compounds. For example, heating strontium carbonate with carbon in an electric furnace gives strontium oxide, which is used for production of strontium metal.

Between 1980 and 1990, world consumption of strontium carbonate increased from ca. 80 000 t/a to > 150 000 t/a. Percentage consumption of strontium carbonate in 1990 was [14]:

|                              |    |
|------------------------------|----|
| Glass for cathode ray tubes  | 74 |
| Electroceramics              | 12 |
| Pyrotechnics                 | 5  |
| Electrolytic zinc extraction | 2  |
| Other uses                   | 7  |

### 57.6.2 Strontium Nitrate

Strontium nitrate, Sr(NO<sub>3</sub>)<sub>2</sub>, ρ 2.986 g/cm<sup>3</sup>, mp 570 °C, forms face-centered cubic crystals. Below 29.3 °C, the solid phase in equilibrium with an aqueous solution on strontium nitrate is strontium nitrate tetrahydrate, Sr(NO<sub>3</sub>)<sub>2</sub>·4H<sub>2</sub>O. The solubility of strontium nitrate (in grams per 100 g solution) at various temperatures is as follows:

|                 |      |      |      |      |
|-----------------|------|------|------|------|
| Temperature, °C | 20   | 29.3 | 60   | 105  |
| Solubility      | 40.7 | 47.0 | 48.3 | 51.2 |

**Production.** Strontium nitrate is obtained by dissolving strontium carbonate in 60% nitric acid.

If the solution is maintained above ca. 30 °C during the evaporation, colorless crystals of the anhydrous compound are formed. After the carbonate, the nitrate is the strontium compound produced commercially in the largest quantities.

**Uses.** Strontium nitrate has long been used in pyrotechnics and as a component of signalling devices. Related devices are used in the United States and Japan as alternatives to portable electric lamps in motor trucks [14].

**Packaging and Storage.** Strontium nitrate is packed in 50 kg polyethylene bags. The following transport regulations apply:

|            |                        |
|------------|------------------------|
| RID/ADR:   | Class 5.1, 22 C        |
| IMDG Code: | Class 5.1, UN no. 1507 |

### 57.6.3 Strontium Chloride

Strontium chloride, SrCl<sub>2</sub>, ρ 3.052 g/cm<sup>3</sup>, mp 875 °C, forms cubic crystals. Its solubility at 20 °C is 34.5%.

**Production.** Strontium chloride is obtained by dissolving strontium carbonate in concentrated hydrochloric acid. The hexahydrate, SrCl<sub>2</sub>·6H<sub>2</sub>O, is formed on crystallizing below 61 °C. On dehydration, the hexahydrate dissolves in its water of crystallization at 61 °C. After passing through the di- and monohydrate stages, strontium chloride becomes fully dehydrated at 320 °C.

**Uses.** Strontium chloride is mainly used as an intermediate in the production of other strontium compounds. Compared with the sulfide, it has the advantage of not reacting with oxygen and carbon dioxide, which facilitates industrial handling.

Strontium chloride hexahydrate is used in toothpastes for sensitive teeth [17].

Strontium chloride is not classified as a dangerous material in transport regulations.

### 57.6.4 Strontium Chromate

Strontium chromate, SrCrO<sub>4</sub>, ρ 3.895 g/cm<sup>3</sup>, forms monoclinic crystals. Strontium chromate is included in dangerous materials regulations [18] (symbol: T).

**Production.** Strontium chromate is produced by precipitating a solution of chromate ions with a strontium salt, or by reacting strontium hydroxide solution with chromic acid.

**Uses.** Strontium chromate (strontium yellow) is used as an anti-corrosion primer for aluminum and its alloys in aircraft and ship construction [19].

### 57.7 Strontium Metal

**Production.** Commercial strontium production relies on a variant of the Pidgeon process, exploiting the reaction proposed by GUNTZ [20]:

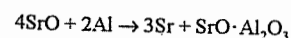

Produced under vacuum, the strontium evolves as a gas and is transported through the production retort to a cooler end where precipitation occurs. The strontium precipitates as a solid and when the production cycle is complete the vacuum is broken and the product removed. Strontium is produced by Timminco Limited in Canada, Pechiney Électrometallurgie in France, and Cal-Stron Corporation in the United States. In addition, production may well occur in the CIS and China but the extent of production, if any, is unknown.

Strontium metal is commercially available as pure metal, and as an alloy with aluminum or aluminum and magnesium.

A typical percentage chemical analysis of commercial strontium is as follows:

|    |           |
|----|-----------|
| Sr | 99.0 min. |
| Mg | 0.20      |
| Ca | 0.10      |
| Ba | 0.50      |
| Na | 0.07      |
| N  | 0.03      |
| Al | 0.01      |
| Fe | 0.015     |

**Transportation, Storage, and Safety.** Due to its reactive nature strontium must be handled with care. The pure metal and the commercial eutectic alloy, 90% Sr–10% Al, are classified as alkaline earth metals n.o.s. (not otherwise specified), UN no. 1393, for the purposes of transportation [21]. This classification is indicative of materials requiring special approved packaging for transport. These two forms of commercial strontium are packed under an inert atmosphere to prevent formation of an oxide coating. Strontium is a strong reducing agent and forms explosive hydrogen gas when in contact with water. Strontium is therefore classified as a flammable solid. Hence strontium is a Class 4.3 material, i.e., one that emits a flammable gas on contact with water. Strontium should therefore be stored in a well ventilated dry place, avoiding all contact with water. It is recommended that protective gloves and glasses should be worn when handling pure strontium. However, commercial alloys of strontium, such as the Sr–Mg–Al master alloy or the family of aluminum-strontium master alloys which contain up to 10 per-

cent strontium do not require these special precautions.

**Uses.** Metallic strontium and master alloys containing strontium have experienced significant expansion in application in modern foundry practice. In aluminum foundries strontium is used as an additive to Al-Si alloys to enhance their mechanical properties and improve the machining performance. Strontium improves the mechanical properties of Al-Si castings by changing the morphology of the eutectic silicon phase. In an unmodified Al-Si alloy this eutectic silicon phase precipitates as coarse acicular plates, which causes the casting to exhibit poor mechanical properties. Modification causes the silicon to assume a fine, interconnected fibrous morphology, resulting in higher tensile strength and greatly improved ductility. Impact resistance and machining characteristics are also enhanced through modification.

The optimum strontium level to achieve the best possible mechanical properties in hypoeutectic Al-Si alloys is 0.005–0.015 percent strontium [22]. The impact of strontium is also influenced by the solidification rate, with faster rates producing better properties.

Early foundry practice utilized sodium as a modification agent. In 1920, PACZ outlined a process by which the solidification structure of Al-Si alloys was modified by the addition of sodium to the melt. The sodium addition produced a fibrous eutectic structure which showed improved mechanical properties, especially elongation.

The principal drawback with sodium is that the effect of the sodium rapidly dissipates as sodium is lost by evaporation and/or oxidation during the holding of the molten alloy.

Strontium has the advantage of imparting a semi-permanent modifying effect, as it is less prone to the fading observed with sodium. This allows the production of so called pre-modified aluminum ingots which can be sold to end users. Nevertheless, many foundries for economic and logistical reasons chose to modify in house.

Recent developments in aluminum metallurgy now suggest that strontium also acts to improve the properties and processing of wrought aluminum alloys.

Strontium appears to act on both the mechanical and forming properties of 6xxx series wrought alloys. These improvements are reported to occur when, in the presence of strontium, the complex intermetallic compounds found in these alloys are precipitated in more favorable crystal structures [23]. Under normal or nonstrontium treated conditions the formation of  $\beta$ -AlFeSi intermetallic is favored. The presence of this compound can contribute to surface defects upon extrusion of 6xxx series alloys. The controlled addition of strontium promotes the less detrimental  $\alpha$ -AlFeSi leading to better surface quality in the extrusion and faster extrusion speeds.

In the 7xxx series of wrought alloys it has been reported that strontium, at levels of at least 0.005 percent, refines the intermetallic phases, including  $Mg_2Si$ , Al-Cu-Mg, and Al-Cu-Fe. When these phases are refined the alloy has enhanced toughness, finer grain size, and can be processed more quickly due to shortened homogenizing times compared to strontium-free alloys [24].

In an aluminum alloy sheet which requires high formability the presence of strontium is reported to reduce the number of intermetallic precipitates. This improves the alloy's formability and reduces the incidence of edge cracking [25].

In ferrous metallurgy strontium finds application as a component in certain foundry grades of ferrosilicon, used as inoculants in gray iron casting. The addition of 0.65–1.05% strontium controls the carbon structure in an iron casting and inhibits the chill. The chill, which is in some cases a desired phenomena, is a rapidly solidified zone in a casting where the formation of mottled iron (cementite and graphite) is favored over a pearlite structure with graphite. By controlling the chill the foundry may be able to decrease the minimum section size in a casting keeping it free from the brittle carbides which would most likely form without inoculation. In addition stron-

tium-bearing inoculants are particularly effective in helping to control internal shrinkage in these castings and thereby enhancing the pressure tightness of the casting [26].

## 57.8 Toxicology

Strontium carbonate is not considered to have any dangerous properties. There are no known occupational diseases associated with handling strontium carbonate, the most important industrial strontium compound.

The strontium ion is slightly toxic. The toxic action of strontium compounds is thus closely associated with the anion of the compound concerned. Strontium behaves similarly to calcium both chemically and biologically. The biological effects of strontium and its compounds have been described in detail [27].

Strontium is deposited preferentially in the bones and teeth of the human body. Strontium salts are not readily absorbed via the intestinal tract.

Symptoms of acute toxicity are excessive salivation, vomiting, colic and diarrhea, and possibly respiratory failure.

The LD<sub>50</sub> values (oral) of various strontium salts (nitrate, hydroxide, chloride, fluoride) are > 2000 mg/kg body weight [28].

Strontium nitrate was administered orally in the food of rats at a concentration of 50 mg/kg (1030 ppm daily for 8 weeks) without harmful effects. Strontium lactate at a level of 16 000 ppm, after more than one year, caused temporary cessation of growth and reduction of bone mineralization [14].

The inhalation of ca. 50 mg/m<sup>3</sup> strontium nitrate (4 h daily for one month, particle size mainly < 5  $\mu$ m) was less well tolerated by male rats. As well as local effects on the respiratory tract, functional and histological systemic changes took place, especially in the liver and kidneys [29].

Strontium oxide and strontium hydroxide have a strongly irritant effect on the skin and mucous membranes, especially the eyes.

No special hygienic measures are taken in the industrialized countries, except in the case of strontium chromate. The TLV/MAK value for strontium nitrate is 1 mg/m<sup>3</sup>, and for strontium sulfate and strontium carbonate, 6mg/m<sup>3</sup> [30]. However, these values are still the subject of debate.

Strontium chromate is included in the list of MAK values for carcinogenic industrial materials in Group 111, A2 [31]. The TRK of strontium chromate (SrCrO<sub>4</sub>) is 0.1 mg/m<sup>2</sup>, calculated as CrO<sub>3</sub>.

## 57.9 References

1. Kirk-Othmer, 2nd ed., 19, 48–49.
2. *Metals Handbook*, 9th ed., vol. 2, American Society of Metals, Metals Park, OH, 1979.
3. C. L. Mantell: "Strontium" in C. A. Hampel (ed.): *Rare Metals Handbook*, 2nd ed., Reinhold Publ. Co., London 1961, pp. 27–31.
4. J. E. Gruzleski, B. M. Closset: *The Treatment of Liquid Aluminum-Silicon Alloys*, American Foundrymen's Society, Des Plaines, IL, 1990, pp. 25–105.
5. *CRC Handbook of Chemistry and Physics*, 67th ed., CRC Press, Boca Raton, FL, 1986.
6. R. D. Goodenough, V. A. Stenger: "Magnesium, Calcium, Strontium, Barium and Radium" in J. C. Bailar (ed.): *Comprehensive Inorganic Chemistry*, vol. 1, Pergamon Press, Oxford 1973, pp. 591–664.
7. *The Economics of Strontium 1992*, 6th ed., Roskill Information Services, London 1992.
8. H. Davy: "Elements of Chemical Philosophy" in J. Davy (ed.): *The Collected Works of Sir Humphrey Davy*, vol. 4, Smith Elder and Company, Cornhill 1840, p. 253.
9. B. Mason, C. B. Moore: *Grundzüge der Geochemie*, Enke Verlag, Stuttgart 1985.
10. H. Gundlach, *Geol. Jahrb.* 76 (1959) 637–712.
11. E. Usdowski, *Contrib. Mineral. Petrol.* 38 (1973) 177–195.
12. H. Harder, *Beitr. Mineral. Petrogr.* 10 (1964) 198–215.
13. J. Griffiths, *Ind Miner. (London)* 293 (1992) 21–33.
14. Roskill: *The Economics of Strontium 1992*, 6th ed., Roskill Information Service Ltd., London 1992.
15. Proinsur, WO 9201630 A1, 1992 (A. Piedrafita Palacios).
16. H. Maeda, Y. Tanaka, M. Fikutomi, T. Asano, *Jpn. J. Appl. Phys.* 27 (1988) 209.
17. M. L. Schole et al., US 3699221, 1972.
18. EC Guideline 91/325, March 1, 1991, EC Number: 024-009-00-4.
19. US Department of the Interior, Bureau of Mines: *Strontium - Uses, Supply, and Technology*, IC 9213, Washington 1989.
20. A. Guntz, F. Benoit, *Bull. Soc. Chim. Fr.* 35 (1924) no. 4, p. 712.

21. International Maritime Organization (IMO): *International Maritime Dangerous Goods Code*, vol. 3, London 1990, p. 4325.
22. B. Closset, J. Gruzleski, *Metall. Trans. A* **13A** (1982) 945-951.
23. Alcan Research and Development, US 3926690, 1975 (L. R. Morris, F. B. Miners).
24. Aluminum Company of America, US 4711762, 1987 (W. D. Vernam, B. W. Lifka).
25. Kobe Steel Inc, JP 62-207 849, 1987 (N. Shinano).
26. *Metals Handbook*, 9th ed., vol. 1, American Society of Metals, Metals Park, OH, 1979, p. 21.
27. G. Thiedemann, *Wiss. Umwelt* **1** (1979) 48-51.
28. US Department of Health and Human Services: Registry of Toxic Effects Chemicals Substances, NIOSH-RTECS-File, Washington 1992.
29. *Patty*, 3rd ed., **2A**, 1894.
30. N. Ju. Tarasenko, Ju. V. Zjuzjukin, *Gig. Sanit.* **5** (1976) 28.
31. Deutsche Forschungsgemeinschaft (ed.): MAK- und BAT-Werte-Liste, Mitteilung 28, VCH Verlagsgesellschaft, Weinheim 1992.

## 58 Barium

ULRICH BAUDIS (§ 58.1); PAUL JÄGER, H. HERMANN RIECHERS, HARTMUT SIMOLEIT †, HEINZ WAGNER, LUDWIG WALTER (§ 58.2); HANS UWE WOLF (§ 58.3)

|   |      |   |      |
|---|------|---|------|
| 58.1 Introduction .....                   | 2337 | 58.2.1.3 <i>Blanc Fixe</i> .....          | 2344 |
| 58.1.1 Physical Properties .....          | 2337 | 58.2.2 Barium Sulfide and Polysulfides .. | 2345 |
| 58.1.2 Chemical Properties .....          | 2337 | 58.2.3 Barium Carbonate .....             | 2346 |
| 58.1.3 Production .....                   | 2338 | 58.2.4 Barium Chlorate .....              | 2348 |
| 58.1.4 Analysis .....                     | 2339 | 58.2.5 Barium Chloride .....              | 2348 |
| 58.1.5 Transportation, Storage, Safety .. | 2339 | 58.2.6 Barium Ferrite .....               | 2349 |
| 58.1.6 Uses .....                         | 2339 | 58.2.7 Barium Oxide .....                 | 2349 |
| 58.1.7 Economic Aspects .....             | 2340 | 58.2.8 Barium Hydroxide .....             | 2350 |
| 58.2 Inorganic Compounds .....            | 2340 | 58.2.9 Barium Nitrate .....               | 2351 |
| 58.2.1 Barium Sulfate .....               | 2342 | 58.2.10 Barium Titanate .....             | 2352 |
| 58.2.1.1 <i>Properties</i> .....          | 2342 | 58.3 Toxicology .....                     | 2352 |
| 58.2.1.2 <i>Barite</i> .....              | 2342 | 58.4 References .....                     | 2352 |

### 58.1 Introduction

Barium is 19th in atomic abundance. Its average content in the earth's crust is estimated to be 250 g/t [10].

The metal is very reactive and does not occur free in nature. However, its compounds are widely distributed. Its major minerals are barium sulfate (barite, heavy spar) and barium carbonate (witherite). Barium sulfate occurs in large deposits throughout the world, and it is the most important raw material for all other barium chemicals.

DAVY first prepared barium metal by electrolyzing mixtures of barium oxide and mercuric oxide and subsequently evaporating the mercury [11]. He proposed the name barium (βαρύς heavy). The principles of the reduction of the oxides of alkaline-earth metals with aluminum were described by MALLETT [12] as early as 1878, but GUNTZ [13] is considered to be the first who obtained a considerable amount of barium of good purity by aluminothermic reduction of the oxide.

#### 58.1.1 Physical Properties

Barium has a body-centered cubic crystal structure at standard temperature and pressure. It is a soft silvery-white metal of medium spe-

cific weight and good electrical conductivity (see Table 58.1). Ultrahigh-purity barium is described as slightly golden yellow [14]. The color changes into silvery white as soon as the surface is contaminated. It is not easy to obtain samples of ultrahigh purity, and therefore accurate measurements of some physical properties of barium metal are difficult to carry out. In fact, the values for some physical properties are still the subject of controversy.

#### 58.1.2 Chemical Properties

Barium is clearly metallic and is strongly electropositive. In all of its compounds it has an oxidation state of 2+. Barium is very reactive, and its compounds have high energies of formation. Barium forms stable salts with nearly all oxoacids. Table 58.2 summarizes the physicochemical properties that are associated with the chemical properties of the element.

Generally speaking, barium is more reactive than magnesium, calcium, or strontium. On heating, it readily combines with the halogens in strongly exothermic reactions. It also reacts with the chalcogens to form BaO, BaS, BaSe, and BaTe [15]. These compounds are also formed by reduction of the carbonate, sulfate, selenate, or tellurate [16]. Barium com-

biner with oxygen even at room temperature. Therefore, the metal must be protected from oxidation by storage under paraffin oil or an inert gas. A series of phosphides can be isolated [17]. Reaction of barium with nitrogen starts at about 250 °C. The compound Ba<sub>3</sub>N<sub>2</sub> is formed [16, 18].

Silicon reacts with barium at 1150 °C to form the silicides BaSi, BaSi<sub>2</sub>, and Ba<sub>3</sub>Si<sub>4</sub> [19]. Barium combines with carbon to form the carbide BaC<sub>2</sub> [20]. At moderately elevated temperatures barium reacts with hydrogen to form the hydride BaH<sub>2</sub> [16]. Barium reacts vigorously with water, liberating hydrogen, to form the strong base barium hydroxide. The metal reacts similarly with alcohols to form the alkoxides and hydrogen. Barium dissolves readily in liquid ammonia. The blue or black solutions contain ammine complexes such as Ba(NH<sub>3</sub>)<sub>6</sub>. Evaporation of the solvent leaves residues of barium amide, Ba(NH<sub>2</sub>)<sub>2</sub>, imide, Ba(NH), and nitride, Ba<sub>3</sub>N<sub>2</sub> [21, 22].

Little is known about organobarium compounds. Alkyl- and arylbarium halogenides, RBaX, as well as dialkyl- and diarylbarium, R<sub>2</sub>Ba, have been synthesized [23, 24].

Barium forms many alloys, and many binary phases have been described [25]. Nevertheless, only the system barium–aluminum has commercial importance.

### 58.1.3 Production

On an industrial scale barium metal is produced in a vacuum by reduction of its oxide with aluminum:

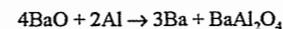

The two-stage process is similar to that for calcium. The raw material is barium oxide.

The barium oxide is mixed with aluminum granules, and the mixture briquetted and charged into long tubular retorts of heat-resistant steel. These are evacuated and heated to ≈ 1100 °C at the end containing the charge, while the other end is kept cool. Molten aluminum and aluminum vapor react with the solid barium oxide, releasing barium vapor, which condenses in the cooler part of the apparatus

[26], where it is collected and cast into chill molds under argon.

Table 58.1: Physical properties of barium.

| Property  | Value  |
|---|--|
| Atomic number <i>Z</i>  | 56   |
| Relative atomic mass <i>A<sub>r</sub></i>                                   | 137.34   |
| Mass number (natural abundance, %) of stable isotopes                       | 130 (0.101), 132 (0.097), 134 (2.42), 135 (6.59), 136 (7.81), 137 (11.3), 138 (71.7) |
| Density ρ at 20 °C  | 3.74 g/cm <sup>3</sup>   |
| Melting point <i>m<sub>p</sub></i>  | 726.2 °C   |
| Boiling point <i>b<sub>p</sub></i> at 101.3 kPa                             | 1637 °C  |
| Hardness (Mohs scale)   | 1.25   |
| Crystal structure   | body-centered cubic  |
| Lattice constant <i>a<sub>0</sub></i> at 20 °C                              | 0.5025 nm  |
| Coefficient of thermal expansion <i>α<sub>t</sub></i> (mean, 0–100 °C)      | 1.8 × 10 <sup>-5</sup> K <sup>-1</sup>   |
| Modulus of elasticity <i>E</i>  | 1.265 × 10 <sup>10</sup> N/m <sup>2</sup>  |
| Heat of fusion <i>ΔH<sub>m</sub></i>  | 7.98 kJ/mol  |
| Heat of vaporization <i>ΔH<sub>v</sub></i>                                  | 140.3 kJ/mol   |
| Specific heat capacity <i>c</i> at 20 °C                                    | 192 J kg <sup>-1</sup> K <sup>-1</sup>   |
| at 900 °C   | 230  |
| Vapor pressure <i>P</i> at 630 °C   | 1.33 Pa  |
| 730   | 1.33 × 10 <sup>1</sup>   |
| 860   | 1.33 × 10 <sup>2</sup>   |
| 1050  | 1.33 × 10 <sup>3</sup>   |
| 1300  | 1.33 × 10 <sup>4</sup>   |
| 1520  | 5.33 × 10 <sup>4</sup>   |
| 1637  | 1.013 × 10 <sup>5</sup>  |
| Electrical resistivity ρ  |  |
| Commercial purity   | 40 × 10 <sup>-6</sup> Ωcm  |
| Extra high purity   | 30 × 10 <sup>-6</sup>  |
| Liquid barium at <i>m<sub>p</sub></i>                                       | 314 × 10 <sup>-6</sup>   |
| Thermal coefficient of electrical resistivity <i>dp/dT</i> (mean, 0–100 °C) | 6.5 × 10 <sup>-3</sup> K <sup>-1</sup>   |

Table 58.2: Physicochemical properties of barium.

| Property                                  | Value                                  |
|---|--|
| Work function <i>Φ</i>                    | 3.38 × 10 <sup>-19</sup> J or 2.11 eV  |
| Ionization potential                      |  |
| First                                     | 8.33 × 10 <sup>-19</sup> J or 5.212 eV |
| Second                                    | 1.60 × 10 <sup>-18</sup> J or 10.00 eV |
| Standard electrode potential              |  |
| Ba <sup>2+</sup> + 2e <sup>-</sup> → Ba   | -2.91 V                                |
| Electronegativity (Pauling)               | 1.02                                   |
| Ionic radius (Ba <sup>2+</sup> , Pauling) | 0.135 nm                               |
| Atomic radius                             | 0.217 nm                               |
| Enthalpy of hydration (Ba <sup>2+</sup> ) | 1290 kJ/mol                            |
| Standard heats of formation (25 °C)       |  |
| BaO                                       | -558 kJ/mol                            |
| BaCl <sub>2</sub>                         | -858                                   |
| BaH <sub>2</sub>                          | -191                                   |
| Ba <sub>3</sub> N <sub>2</sub>            | -377                                   |

BaAl<sub>4</sub> is an intermediate [27], and the net reaction is actually the sum of three reactions:

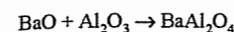
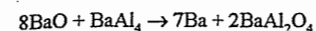
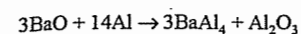

In the laboratory the aluminothermic reduction of barium oxide is also the most useful method of preparation [7, 21, 28–31]. It is also the method of choice for preparing of high-purity samples [32].

Silicon powder can be used to reduce barium oxide, but somewhat higher temperatures are required, 1200 °C in a vacuum [33]:

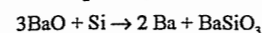

Either no reduction or only partial reduction combined with alloying occurs when barium oxide is treated with magnesium, calcium, sodium, or potassium. Barium can be isolated by reaction of barium iodide with sodium, whereas the chloride does not react. Electrolytic methods are not useful for industrial production and are only rarely useful for laboratory synthesis because of the solubility of barium in its molten halides [34]. It is unlikely that barium has ever been isolated in sufficient purity by electrolysis, even though this method has been mentioned numerous times [2].

### 58.1.4 Analysis

Volatile barium compounds impart a pale green color to flames, and this is an effective, simple qualitative test for barium (455.4, 493.4, 553.6, and 611.1 nm).

Barium is separated from magnesium, strontium, and calcium by precipitation from a dilute solution in nitric or hydrochloric acid with a solution of potassium dichromate in aqueous acetic acid. Barium is determined gravimetrically by precipitation of the sulfate [35]; small quantities are determined spectrometrically [36].

The metallic impurities in commercial barium (Table 58.3) are determined by atomic absorption and flame emission spectroscopy. Trace impurities are best determined by inductively coupled emission spectroscopy (ICP) [38]. The carbon content in barium is determined by combustion; nitrogen, by the

Kjeldahl method; and hydrogen, by vacuum hot extraction. Vacuum hot extraction is not useful for analysis of oxygen. Neutron activation analysis based on the reaction

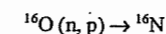

is the recommended method for determination of oxygen in alkaline-earth metals [39].

Table 58.3: Chemical analysis of commercial barium [37].

| Element   | Percentage |
|-----------|------------|
| Ba        | 99.3 ± 0.3 |
| Sr        | 0.8        |
| Ca        | 0.25       |
| Al        | 0.05       |
| Mg        | 0.02       |
| N         | 0.02       |
| Fe        | 0.01       |
| Cl        | 0.01       |
| C         | 0.01       |
| Li, Na, K | 0.01       |

### 58.1.5 Transportation, Storage, Safety

Barium metal is commercially available in bars of 5–20 kg or in rods 22 mm in diameter and 400 mm in length. The rods can be cut into small pieces or extruded into wires.

Barium is packaged in air-tight steel drums containing up to 100 kg of the metal under argon or paraffin oil. Smaller amounts (1–10 kg) are packaged in tin cans, and even smaller samples are packaged in hermetically sealed glass bottles [40, 41].

Barium is a flammable solid and cannot be mailed. If it comes into contact with water, there is always the danger of explosion on account of the liberated hydrogen. Therefore barium should always be stored in a dry, well ventilated place and every contact with moisture and air avoided. Protective glasses and safety gloves should be worn while handling barium. Burning barium can be extinguished with sand, aluminum oxide, etc.

### 58.1.6 Uses

The main use of barium and barium–aluminum alloys is as *getter* to remove the last traces of unwanted gases from television pic-

ture tubes, transmitter valves, and other vacuum tubes [42–48]. Barium and its aluminum alloys also are used in incandescent lamps [49, 50]. Barium is particularly well suited as a getter because it has a low vapor pressure at the working temperatures of the tubes and is very reactive toward undesired gases, such as oxygen, nitrogen, hydrogen, carbon dioxide, water vapor, even removing residues of inert gases by inclusion.

Many other uses of barium have been described in the literature, but they are minor. For example, barium has been used in bearing alloys [51]; in lead–tin soldering alloys, where it increases creep resistance [52]; in nickel alloys for spark plugs [53]; in alloys with calcium, silicon, aluminum, and manganese that are used as deoxidizers for high-grade steel [19, 54]; and as an inoculant for steel and cast iron [55, 56]. Barium has also been used as a modifying agent for silumin, instead of strontium or sodium, because barium also refines the structure of the eutectic aluminum–silicon alloy [57]. Barium is also a good reducing agent; however, it is not normally used for this purpose because of its high atomic mass and its relatively high price, one kilogram of the metal costing about DM 100 (\$260) in 1983.

### 58.1.7 Economic Aspects

The leading producer is Degussa AG, Germany. Production is about 30 t/a of pure metal and 10 t/a of barium–aluminum alloy [58], essentially covering the demand in the West. Some barium metal, perhaps about 6 t/a, is produced by Union Carbide Corp. in the United States. There may also be production facilities at Pfizer Inc. (United States) and Chromasco Corp. (Canada), but no metal is produced there at present [59]. Nothing is known about production in the former USSR, although facilities doubtlessly exist.

It is difficult to predict the future demand for barium. However, the replacement of television picture tubes by liquid crystal displays, or similar systems, is likely to decrease demand and production over the long term.

## 58.2 Inorganic Compounds

**History.** The first mention of barium compounds dates from the year 1602 when V. CASCIOROLUS, in Bologna, realized that barite heated in the presence of organic substances, phosphoresces in the dark. Much later, after 1774, C. W. SCHEELE discovered barium oxide and described its properties. He noted that a precipitate formed when sulfuric acid was added to barium oxide dissolved in water.

J. G. GAHN recognized that this was a reaction of the oxide to form barite, i.e., that the oxides were a new class of compounds. At that time the oxide was given the name baryta ( $\beta\alpha\rho\upsilon\varsigma$  = heavy), which in some countries is still the name for technical grades: caustic baryta for the oxide, hydrate of baryta for the hydroxide. Today, however, the mineral heavy spar,  $\text{BaSO}_4$ , is meant by baryta or barite. Barium carbonate also occurs in nature. Native barium carbonate was named witherite, for W. WITHERING discovered the mineral in Cumberland, Great Britain, in 1783.

**Raw Materials and Processing.** The most important barium mineral is barite (barytes, heavy spar, barium sulfate,  $\text{BaSO}_4$ ), today almost exclusively used as the raw material for the production of barium compounds. Barite occurs all over the earth in hydrothermal vein and sedimentary deposits. The main deposits of the mineral witherite ( $\text{BaCO}_3$ ) are situated in England, Romania, and the former USSR, but witherite is no longer of economic importance. No other mineral containing barium is used as a raw material for barium or its compounds at present.

The maximum world output of barite was  $\approx 8.3 \times 10^6$  t (1981); however, only 7–8% of this was used for the production of other barium compounds. Figure 58.1 shows how dressed barite is converted into other barium compounds. The barite is first reduced with carbon to give water-soluble barium sulfide, which is used mainly as an intermediate for the production of all other barium compounds and lithopone [60–64].

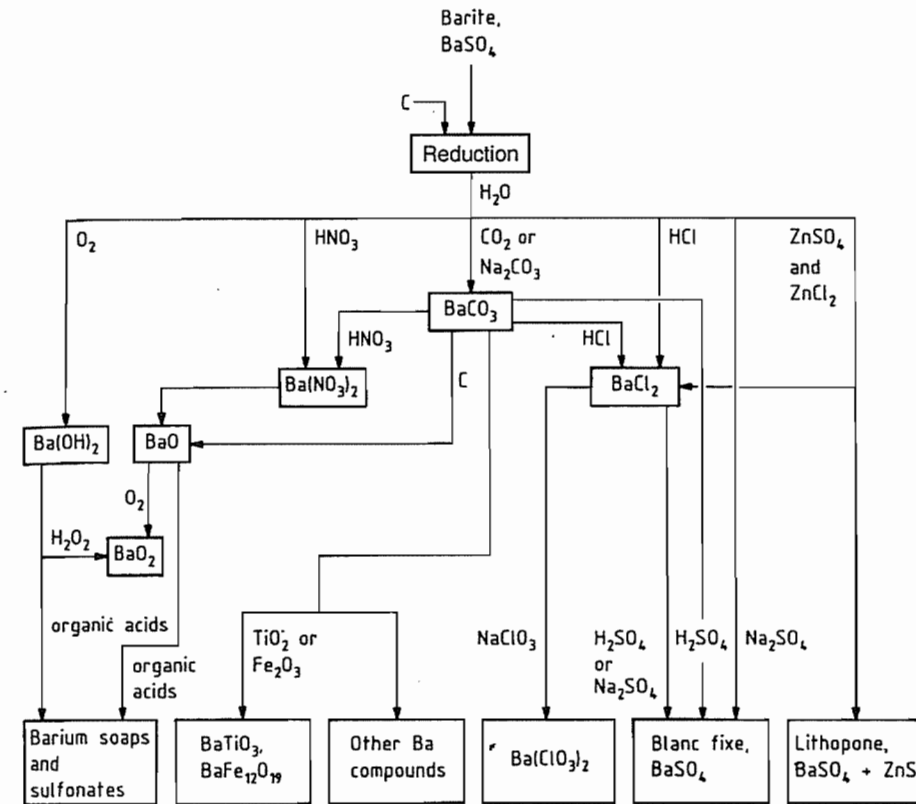

Figure 58.1: Production pathways to various barium compounds starting from barite.

**Chemical Analysis.** All barium compounds may be identified by the green color imparted to flames. For quantitative analysis, atomic absorption spectroscopy, flame emission spectroscopy, X-ray spectroscopy, complexometry, and gravimetry are suitable.

**Economic Aspects.** Production data is available only for barium sulfate, the most important barium compound and the starting material for the production of most other barium compounds. The reason for this is the small number of producers of barium compounds worldwide, and these release only a limited amount of production information. The worldwide production of barite ( $\text{BaSO}_4$ ) has increased from 3900 kt in 1970 to 8300 kt in 1981. This dramatic increase in production was the result of increased exploration and drilling for oil and gas, itself a result of the oil

crisis of the early 1970s. Coupled with a reduction in exploration and drilling in 1982, the production of  $\text{BaSO}_4$  fell in 1982 to about 7300 kt, a trend that has continued. At this rate of production the known and probable reserves, estimated at 400 Mt worldwide, will last at least 60 years. The production by country is shown in Table 58.4.

Table 58.4: Estimated production of barium sulfate,  $\times 10^3$  t.

| Country             | 1980 | 1981 | 1982 |
|---------------------|------|------|------|
| United States       | 2030 | 2590 | 1800 |
| Canada              | 86   | 82   | 77   |
| Mexico              | 270  | 318  | 254  |
| South America       | 845  | 820  | 800  |
| Western Europe      | 1200 | 1100 | 1030 |
| Comecon             | 800  | 810  | 820  |
| Africa              | 480  | 600  | 580  |
| Middle and Far East | 1810 | 1960 | 1890 |
| World production    | 7520 | 8280 | 7250 |



Around 88–90% of the world production of barite is used to increase the density of drilling muds. About 7–8% is used to produce barium compounds. Over one half of this amount is used to produce barium carbonate. Other important compounds are the chloride, the hydroxide, and blanc fixe. Only about 3–5% of the world production is used as a filler — both bleached and unbleached — in paints, rubbers, etc.

## 58.2.1 Barium Sulfate

Barium sulfate is the most important barium compound, and the mineral barite,  $\text{BaSO}_4$ , also called heavy spar or baryte, is by far the most important barium mineral.

### 58.2.1.1 Properties

Barium sulfate,  $\text{BaSO}_4$ . The industrially precipitated product is called blanc fixe. Pure  $\text{BaSO}_4$  forms colorless rhombic crystals of refractive index  $\approx 1.64$ , hardness 3–3.5 (Mohs scale), and density  $\rho$  4.48  $\text{g/cm}^3$ . Heating  $\text{BaSO}_4$  decomposes it, the rate increasing with temperature over the range 1100–1500 °C. The main products are  $\text{BaO}$ ,  $\text{SO}_2$ , and  $\text{O}_2$ . For this reason melting points given in the older literature 1345 °C or 1580 °C differ. Barium sulfate is almost insoluble in water, the solubility being  $2.5 \times 10^{-4}\%$  at 20 °C and  $3.9 \times 10^{-4}\%$  at 100 °C. Barium sulfate is more soluble in hot concentrated sulfuric acid and in melts of alkali-metal salts. The most important reaction of barite is its reduction with carbon to produce barium sulfide.

### 58.2.1.2 Barite

In nature barite rarely occurs as a pure white mineral; generally, its color is yellowish, pink, reddish brown, dark gray, or black. The main impurities are quartz, calcium carbonate, iron and manganese oxides, fluorite, strontium sulfate, pyrite, lead glance, zinc blende, and sometimes bituminous substances, the impurities and their amounts depending on the particular deposit. To remove these impurities before the barium sulfate is

used industrially, in most cases barite is given a preliminary treatment to increase the  $\text{BaSO}_4$  content to 90–97%.

**Deposits.** Barite deposits are found in all regions of the world. The most important in Europe are found in Ireland, France, Italy, Germany, and Greece, but barite is also mined in Spain, Turkey, and Yugoslavia. Another important producer of barite is the former USSR.

The most significant deposits in the Americas are found in the United States, but other large deposits are mined in Canada, Mexico, Peru, and Argentina.

Morocco is the most important producing country in Africa. Smaller quantities are mined in Algeria, Tunisia, and Egypt. Large deposits are situated in China, India, Thailand, and Iran.

**Mining and Dressing of the Ore.** Barite is usually mined in open cuts, only sometimes in open pits or underground galleries. The ore is washed in trommels to remove adherent argillaceous impurities, then crushed in breakers, and classified. The various grain sizes are liberated from the mostly quartz gangue in jigs, thus enriching the barium sulfate. This wet mechanical dressing is adequate for many uses. If there is a high degree of intergrowth of quartz and barite and if the ore contains much iron, lead, or zinc, flotation is required. This produces 98%  $\text{BaSO}_4$  [65]. Sometimes barite is a by-product of the flotation of pyritiferous ores. The flotation agents and the pH depend, among other things, on the impurities present in the crude ore [66]. Generally the barite is wet ground to a grain size of 0.1 mm before flotation. Sodium oleate, tall oil, oleic acid, and most recently alkyl sulfonates and sulfates have been used as collectors. Water glass is the preferred depressant, especially for quartz and iron oxides. Flotation processes to depress the  $\text{BaSO}_4$  and float the impurities are confined to a few special cases, e.g., ore rich in fluorite [67].

Another method applicable only to special barite types is based on the tendency of these barites to decrepitate. The broken ore is heated to 700 °C in rotary kilns, the barite crystals

bursting while the gangue is unaffected. The decrepitated fines rich in barite are screened off from the gangue. The yield depends above all else on the suitability of the barite for this treatment.

Barite grades with special properties are produced for the various industrial uses.

**Drilling Muds.** About 88–90% of the world output of barite is ground and used to increase the density of drilling muds, especially for drilling oil and gas wells. The muds consist of an aqueous clay suspension and additives. The large amount of barite that can be added to this suspension allows adjustment of the density to a high value without the viscosity being affected significantly. The increased density allows faster discharge of cuttings and prevents blowouts. The standards for drilling-mud-grade barite vary from country to country; for instance, they are described in the OCMA or API standards [68]. However, in every case the barite must be free from water-soluble salts because these cause clay suspension to flocculate [69].

For the production of barite for drilling muds, generally it is sufficient to jig the ore to increase the density by removing the quartz. In most cases the other impurities do not cause trouble. On the other hand, barite that has been floated must be heated or treated in some other way to destroy its hydrophobic character.

**Raw Material for Barium Chemicals.** The 7–8% of the total barite production to be used as a raw material for other barium compounds is always reduced to barium sulfide as the first stage. The  $\text{BaSO}_4$  content must be  $> 95\%$ , and the  $\text{BaSO}_4$  should contain as little silica and iron as possible, as these impurities reduce the yield of water-soluble barium sulfide. Fluorspar (fluorite) and lead glance interfere with the reduction. Such barite is generally shipped in bulk as coarsely broken material, either granular (jigged) or ground (floated).

**White Ground Barite Filler.** Ground barite is used as a filler owing to its resistance to chemicals and weathering, its wettability and dis-

persibility, and its low adsorption of binders. The properties of barite flour vary, depending on the commercial grade:

|   |                          |
|---|--------------------------|
| Grain size                                  | 0.1–40 $\mu\text{m}$     |
| Brightness (reference, $\text{MgO} = 100$ ) | 85–95                    |
| Refractive index $n_D$                      | $\approx 1.64$           |
| Oil requirement                             | 10–12 g of oil/100 g     |
| Bulk density, tamped                        | 1.4–2.2 $\text{g/cm}^3$  |
| Density                                     | 4.0–4.25 $\text{g/cm}^3$ |

Some white barite grades may be ground directly without further treatment. More usual, however, is to subject the spar to coarse crushing and gravity dressing. Then the granular material is treated in bleaching vats with hot dilute acid, preferably sulfuric or hydrochloric acid, to remove the colored iron or manganese oxides, washed, and dried. The bleached spar is dry-milled in edge or ball mills to obtain the desired grain size, then air classified.

There is a more economical procedure: the coarsely crushed, gravity dressed barite is ground to the desired grain size by continuous wet milling in lined ceramic tubes. The screened suspension of ground material is bleached in agitator vessels, with dilute sulfuric or hydrochloric acid along with reducing agents (e.g., sodium sulfite) or oxidizing agents (e.g., nitric acid), depending on the kind of impurities, then washed, decanted, and dried. If floated barite is used in this process, then the barite must be floated again after bleaching to remove the decomposed organic material [70].

A third bleaching procedure lacks economic importance: here the barite is heated in a rotary kiln by adding alkali-metal salts, e.g., sodium chloride or sodium hydrogensulfate. This procedure is confined to special cases due to its high cost.

The specifications for ground barite are given in DIN 55911 for Germany and ISO 3262 internationally. The requirements of the buyers differ in regard to grain size and whiteness. Some products, such as EWO-Albaryt grades of the Deutsche Baryt-Industrie, Bad Lauterberg/Harz, are equivalent to synthetic blanc fixe in many respects. White ground barite is generally shipped in 50-kg paper bags.

Barite flours are mainly used as fillers and extenders in paints, varnishes, plastics, rubber, linoleum, sealing compounds, stoppers, plaster, and adhesives (3–4% of the total barite production). High-quality grades can be used as an X-ray-opaque medium in medicine, insofar as the grades meet the requirements of the individual countries as given in USP, EP, JP, DAB, etc.

### 58.2.1.3 Blanc Fixe

Precipitated barium sulfate is usually called blanc fixe. It is mainly used as a filler and extender, in some fields also as a white pigment. The most important properties for the consumer are its insolubility in water and organic binders, its high degree of whiteness, and its homogeneous granulation:

|                                   |                           |
|-----------------------------------|---------------------------|
| Grain size                        | 0.1–20 μm                 |
| Average grain size                | 0.2–2 μm                  |
| Brightness (reference, MgO = 100) | 95–99                     |
| Refractive index $n_D$            | ≈ 1.65                    |
| Oil requirement                   | 12–22 g of oil/100 g      |
| Bulk density, tamped              | 0.9–2.2 g/cm <sup>3</sup> |
| Density                           | 4.0–4.4 g/cm <sup>3</sup> |

**Production.** Blanc fixe is usually precipitated in stirred tanks from solutions of barium chloride or barium sulfide by adding dilute sulfuric acid or sodium sulfate solutions. The sulfuric acid or the sodium sulfate solution must be free from heavy metals that can impart color to the product.

The method of manufacture and the reaction conditions depend on the ultimate use of the blanc fixe, especially the desired grain size. For example, fine-grained blanc fixe is produced by rapid precipitation from highly concentrated solutions at high pH and low temperatures. Coarse blanc fixe is produced from dilute solutions at high temperatures, say 80–100 °C. The use of seed crystals and prolonged residence time, e.g., by stirring for an extended period at low pH, produces a larger average grain size in the finished product. The precipitated blanc fixe is filtered or centrifuged and washed. It is drawn off and packed as paste, slurry, or powder, the last involving an additional process step of drying and perhaps one of regrinding.

A special problem in preparing blanc fixe from barium sulfide and sodium sulfate solutions is washing out the sodium sulfide. However, this problem can be overcome by enlarging the particle size of the extremely fine material by sintering (at 300–1000 °C) with fluxes like sodium sulfate and extracting the clinker [71].

Another procedure for the manufacture of blanc fixe is based on the conversion of an aqueous suspension of barium carbonate with dilute sulfuric acid, sometimes in the presence of small amounts of hydrochloric acid. The resulting product is characterized by its whiteness [72].

Formerly blanc fixe was obtained as a by-product of hydrogen peroxide production by reaction of barium peroxide and sulfuric acid—but today hydrogen peroxide is prepared by other procedures.

**Quality Specifications.** In Germany, the standards for blanc fixe, the methods of analysis, and tests are defined in DIN 55911. The various grades differ mainly in grain size. The smaller the grain diameter the higher the luster. In fact, grades are still sometimes characterized as mat, semimat, or lustrous.

The standards for blanc fixe to be used as X-ray-opaque medium in medicine are described and defined for the various countries in USP, EP, JP, DAB, etc. The standards deviate slightly from one to another.

**Shipping and Packing.** Blanc fixe is shipped as powder (25- or 50-kg paper bags, 1000-kg bags, or in silo trucks); slurry (30–40% water in 460-kg plastic barrels or in tank trucks); and agglomerate-free paste (25–35% water in 50-kg polyethylene-lined iron barrels). Because blanc fixe is nontoxic, it is not classified as a dangerous good.

**Uses.** About 70% of the blanc fixe consumed in Western Europe is used in paint and varnish as well as in printing ink as a filler. It is used as a coating pigment to upgrade the surface of paper and is sometimes used as a pulp filler. Photographic paper requires grades free from sulfur and heavy metals, but recently this mar-

ket has lost significance. Blanc fixe is also used as a filler in plastics, rubber, and adhesives and as an additive in the negative plates of lead storage batteries. Special grades are used as a medium opaque to X rays for medical purposes (stomach X rays).

### 58.2.2 Barium Sulfide and Polysulfides

The principal intermediate between barium sulfate and other barium compounds is barium sulfide.

**Properties.** Pure barium sulfide, BaS,  $\rho$  4.3 g/cm<sup>3</sup>, forms colorless cubic crystals. It melts above 1200 °C. Its heat capacity  $c_p$  is 287 Jkg<sup>-1</sup>K<sup>-1</sup>. At room temperature barium sulfide is unaffected by dry air, but over the range 500–1000 °C it is oxidized to barium sulfate, at an ever-increasing rate. In humid air containing carbon dioxide, some barium carbonate forms, and the odor of hydrogen sulfide is noticeable. The solubility of barium sulfide in water depends strongly on the temperature, the maximum being near 90 °C:

| °C    | 0   | 20  | 40   | 60   | 80   | 90   | 100  |
|-------|-----|-----|------|------|------|------|------|
| % BaS | 2.8 | 7.3 | 13.0 | 21.7 | 33.3 | 40.2 | 37.6 |

Owing to complete hydrolysis a solution of sulfide is actually an equimolar solution of barium hydroxide, Ba(OH)<sub>2</sub>, and barium hydrosulfide, Ba(SH)<sub>2</sub>. Accordingly, barium sulfide does not precipitate when the solution is cooled; instead, a double salt of composition Ba(OH)<sub>2</sub>·Ba(SH)<sub>2</sub>·10H<sub>2</sub>O precipitates. Excess hydrogen sulfide converts the barium hydroxide in solution quantitatively to barium hydrosulfide, which can be precipitated as Ba(SH)<sub>2</sub>·4H<sub>2</sub>O by addition of ethyl alcohol.

Aqueous barium sulfide reacts with carbon dioxide to form barium carbonate, BaCO<sub>3</sub>, and the solution is also susceptible to atmospheric oxygen, which easily oxidizes the hydrosulfide to polysulfide, thiosulfate, and sulfite.

**Production.** Barium sulfide is produced by reducing barite (BaSO<sub>4</sub>) with carbon. The net reaction is

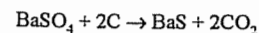

However, the thermodynamic data suggests that the actual reducing agent is carbon monoxide [73]:

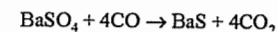

Barium sulfite, BaSO<sub>3</sub>, is an intermediate [74]. The CO forms in the reaction between carbon and CO<sub>2</sub>, the Boudouard equilibrium:

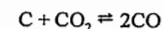

The barite should have a BaSO<sub>4</sub> content ≥ 95%. Large amounts of impurities, especially silica and iron oxide, reduce the yield of water-soluble barium sulfide by forming the insoluble barium silicates and ferrates. The spar is ground to 0.1–2 mm and mixed with low-ash reducing carbon or coke, one part of carbon to 4–6 parts of barite.

Today the reduction is usually carried out in a continuous process centered around rotary kilns up to 50 m long. A burner at the outlet of the kiln fired with fuel oil, natural gas, or coal dust provides countercurrent heating. Reduction takes place at 1000–1200 °C; average residence time is 90–120 min. The operating conditions must be carefully controlled to prevent secondary reactions with the gangue and to impede caking. The barium sulfide melt should be obtained in a fine-grained condition. The sulfide melt leaves the kiln continuously through a cooling drum. Generally further grinding is not necessary.

The older batch method, using rotary kilns, is still in use, especially in smaller companies. Essentially the operating conditions correspond to those of the continuous process. However, batch operation is characterized by lower output and higher unit operating cost.

Recently, various processes using a fluidized-bed kiln have been reported. Here, the pulverized spar, e.g., from flotation, is granulated together with carbon and reacted in a fluidized bed, a part of the carbon being used for heat generation and a part for reduction [74, 75]. Other processes use a reducing gas, e.g., carbon monoxide or methane, instead of carbon. The gas serves three functions: it provides heat upon combustion, it supports the fluidization, and it is the reducing agent. The

advantages are a reduction temperature below 1000 °C, a residence time less than 1 h, and a more favorable energy balance [76, 77]. However, large-scale plants of this kind have not been reported.

Crude barium sulfide (black ash) is leached countercurrently with 50–70 °C water to dissolve the barium sulfide. This leaching is carried out batchwise in batteries of Shank leaching vats or continuously in closed agitated vessels followed by several thickeners. The suspended matter is filtered off, and the lye, containing 13–18% BaS, is immediately treated further to prevent oxidation or crystallization. At this point the barium sulfide solution is very pure.

The residue still contains 50% barium, in the form of compounds insoluble in water, such as silicates and ferrates of barium and unreacted barite. The silicates and ferrates can be dissolved with hydrochloric acid to form barium chloride; however, this process is often uneconomical because of the cost of purifying the barium chloride solution. To avoid these problems a recent method proposed that the leaching residue be resuspended in water and, by adding hydrogen sulfide, the portion of barium compounds that are insoluble in water be converted into readily soluble barium hydrosulfide that can be led back into the sulfide lye [78].

**Quality Specifications.** Barium sulfide is available only as a technical-grade, granular, dark gray crude product called black ash. It contains 75–85% water-soluble BaS, barium compounds soluble in hydrochloric acid (8–10% as BaO), 2–4% SiO<sub>2</sub>, 2–3% Fe<sub>2</sub>O<sub>3</sub> and Al<sub>2</sub>O<sub>3</sub>, 2–4% BaSO<sub>4</sub>, and 1–2% carbon. The economic value depends directly on the content of water-soluble BaS, which is determined analytically by acidimetry and iodometry.

**Packing and Shipping.** Barium sulfide is packed in multilayered paper bags with an inner polyethylene bag or in 50-kg polyethylene bags. Shipment is governed by TMDG Class 6.1, UN 1564, and RID/ADR Class 6.1, 71.

**Uses.** Barium sulfide is mainly used for the production of other barium compounds, especially lithopone. Some BaS is used for the production of hydrogen sulfide; in this case, barium chloride is the by-product. Other uses (depilatories, purification of mineral acids) are far less important.

**Barium Polysulfides.** The polysulfides have the general composition BaS<sub>x</sub> (x = 2–5). They include barium disulfide, BaS<sub>2</sub>; barium trisulfide, BaS<sub>3</sub>; barium tetrasulfide, BaS<sub>4</sub>; barium tetrasulfide monohydrate, BaS<sub>4</sub>·H<sub>2</sub>O; barium tetrasulfide dihydrate, BaS<sub>4</sub>·2H<sub>2</sub>O; and barium pentasulfide, BaS<sub>5</sub>. Polysulfides form when barium sulfide solutions are oxidized by air, when sulfur is dissolved in barium sulfide solutions, when barium sulfide is fused with sulfur in a vacuum, etc.

The isolation of individual polysulfides from solution is difficult because of their tendency to decompose. Technical barium polysulfide is produced by grinding barium sulfide with sulfur (Ba:S = 1:4–5). It is marketed as a grayish-yellow powder. The formation of polysulfide does not take place until the powder is dissolved.

A new process, however, produces a mixture of true barium polysulfides, BaS<sub>4–5</sub>, by sudden evaporation of a solution in a spray dryer [79]. The resulting light yellow powder is stable and dissolves in water without leaving a residue.

As a 1–3% solution barium polysulfide is a fungicidal and acaricidal agent used in fruit and grape growing.

Shipment of barium polysulfides is governed by the IMDG Class 6.1, UN 1564, or RID/ADR Class 6.1, 71.

### 58.2.3 Barium Carbonate

Barium carbonate is the most important manufactured barium compound. It occurs in nature as witherite, which has little economic significance due to rareness, inevitable impurities, and almost fully depleted deposits.

**Properties.** Barium carbonate, BaCO<sub>3</sub>, mp 1360 °C accompanied by loss of CO<sub>2</sub>. Pure

barium carbonate is a white fine crystalline powder having several modifications:

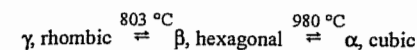

The rhombic modification is isomorphous with the carbonates of calcium (aragonite), strontium (strontianite), and lead (cerussite).

Barium carbonate has a density of 4.29 g/cm<sup>3</sup>. Its solubility in water at 20 °C is only 2 × 10<sup>-3</sup>%, although it is a little more soluble in water containing CO<sub>2</sub>. Its refractive index is ≈ 1.6. Its heat capacity c<sub>p</sub> at room temperature is 433 J kg<sup>-1</sup>K<sup>-1</sup>.

When barium carbonate is heated, it loses carbon dioxide and forms barium oxide. The dissociation is promoted by traces of water. Barium carbonate and its decomposition product barium oxide are partially soluble in each other at elevated temperatures, at 1000 °C ≈ 10 mol% oxide in the carbonate and 5 mol% of carbonate in the oxide — this partial solubility was not adequately appreciated in the older literature. Moreover, there is a eutectic at 1060 °C with 34 mol% barium oxide. The equilibrium CO<sub>2</sub> pressure above barium carbonate saturated with oxide increases rapidly above 1000 °C [80, 81]:

| °C   | 900 | 1000 | 1100 | 1200 | 1250 | 1300 | 1360  |
|------|-----|------|------|------|------|------|-------|
| kPa  | 0   | 0.21 | 1.6  | 10.1 | 21.6 | 46.4 | 101.3 |
| Torr | 0   | 1.6  | 12   | 76   | 162  | 348  | 760   |

**Production.** Barium carbonate is produced almost exclusively by precipitation from barium sulfide solutions. There are two processes:

- precipitation with carbon dioxide
- precipitation with soda

The first is based on the reactions

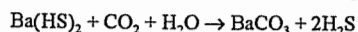
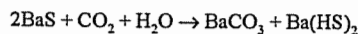

The carbon dioxide is usually available from combustion gases or native carbonic acid. The precipitation is carried out batchwise in gastight vessels, several of which may be arranged in series to absorb the carbon dioxide that breaks through with the hydrogen sulfide in fresh lye; a utilizable hydrogen sulfide poor in carbon dioxide is produced in this

way. Also there are continuous processes, e.g., using precipitation columns [82, 83].

The second process is based on the reaction

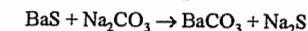

The barium sulfide lye containing 15–18% BaS is run into 30% soda solution in agitator vessels.

The decision to favor one or the other of the two processes does not depend only on the availability and relative cost of carbon dioxide or soda. Above all else the value or sales prospects of the by-products, H<sub>2</sub>S or Na<sub>2</sub>S, is decisive. The hydrogen sulfide must be worked up to sulfur, sulfuric acid, sodium hydrosulfide, or sodium sulfide. The dilute sodium sulfide solution produced in the soda process in most cases is upgraded to crystalline sodium sulfide hydrate (60% Na<sub>2</sub>S).

The main impurity in BaCO<sub>3</sub>, sulfur as sulfide, elementary sulfur, or sulfate, is the major problem. Patents offer a number of solutions: adding aluminum powder to the barium sulfide lye to reduce the polysulfide sulfur [84], continuously maintaining a residual barium sulfide content in the solution of 0.5% during the precipitation with carbon dioxide to keep the sulfur dissolved [85]; or a careful step-by-step precipitation, perhaps first to BaCO<sub>3</sub> and Ba(HS)<sub>2</sub> and then to BaCO<sub>3</sub> and H<sub>2</sub>S [82, 83].

**Quality Specifications.** Purity, bulk density, and grain-size distribution depend on the particular use. Usually, low sulfur and heavy-metal content is demanded. The manufacturers of electroceramics require low strontium content. The numbers below refer to products of various origin, quality, and process and should only be regarded as reference values:

|                                    |                                 |
|------------------------------------|---------------------------------|
| Barium carbonate                   | ≥ 98.5%                         |
| Sulfur                             | 0.08 (0.02)%                    |
| Strontium                          | 0.5–1.4 (0.3)%                  |
| Iron                               | 6–20 × 10 <sup>-4</sup> %       |
| Insoluble in HCl <sub>(soln)</sub> | 0.1–0.6%                        |
| Density                            | 4.29 g/cm <sup>3</sup>          |
| Bulk density, tamped               | 0.4–1.8 (202) g/cm <sup>3</sup> |
| Grain size, < 5 μm                 | 80–95%                          |

An important standard for barium carbonate as a sulfate-binding agent is its reactivity. This is determined by conversion of barium carbonate with known quantities of sulfate, as gypsum water or sodium sulfate solution.

**Packing and Shipping.** Barium carbonate is stored in silos and shipped in 50-kg multilayer paper bags,  $\approx$  1000-kg bags, or silo wagons. Shipment is governed by the IMDG Class 6.1, UN 1564, or RID/ADR Class 6.1, 71.

**Uses.** Barium carbonate is used to remove the detrimental sulfate ion from the input solutions of the alkali-metal chloride electrolysis, e.g., the mercury process, as well as from industrial waters of various kinds. In brick production barium carbonate is a binder for the soluble sulfates in the raw mixture. The formation of insoluble barium sulfate prevents discoloration (efflorescence) during production. Moreover, barium carbonate reduces the tendency of baked bodies to effloresce on exposure to moisture. Barium carbonate is used to incorporate barium oxide into special fine glassware, apparatus glass, and many optical glasses. The barium oxide increases the workability of the glass melt, improves the mechanical and chemical resistance, and increases the refractive index of the glass. Barium in television screens prevents the leakage of X rays.

Barium carbonate is also used in enamels, the electroceramic barium titanate and the magnetoceramic barium ferrites. These last two uses require high-purity  $\text{BaCO}_3$ .

### 58.2.4 Barium Chlorate

Barium chlorate monohydrate,  $\text{Ba}(\text{ClO}_3)_2 \cdot \text{H}_2\text{O}$ , forms monoclinic short prismatic crystals of density  $3.18 \text{ g/cm}^3$ . Its solubility in water is 21.2% at  $10^\circ\text{C}$  and 51.3% at  $100^\circ\text{C}$ . Near  $120^\circ\text{C}$  barium chlorate begins to lose its water of crystallization, and above  $250^\circ\text{C}$  oxygen is lost. The anhydrous salt melts at  $415^\circ\text{C}$ ; however, explosions can occur on fusion or if a mixture with sulfur or organic substances is heated even at  $110^\circ\text{C}$ . Barium chlorate is a good oxidant.

Barium chlorate is produced on an industrial scale by mixing concentrated barium chloride solution into hot concentrated sodium chlorate solution. On cooling, barium chlorate monohydrate crystallizes. Although it crystallizes in a rather pure form, barium chlorate can be purified even further by recrystallization.

This double conversion is more economical than electrolysis of a barium chloride solution, a process that is no longer used.

Barium chlorate is almost exclusively used in pyrotechnics, where it produces a green color. In addition, it has been used as an oxidizing agent, e.g., in textile printing. Shipment is governed by IMDG Class 5.1, UN 1445, or RID/ADR, Class 5.1, 4a.

### 58.2.5 Barium Chloride

Anhydrous barium chloride  $\text{BaCl}_2$ , *mp*  $962^\circ\text{C}$ ,  $\rho_{20}$   $3.91 \text{ g/cm}^3$ , crystallizes in two modifications:  $\alpha$ - $\text{BaCl}_2$  (rhombic, mostly lamelliform) and  $\beta$ - $\text{BaCl}_2$  (cubic). The conversion temperature is  $925^\circ\text{C}$ . Barium chloride is soluble in water:

| $^\circ\text{C}$  | 0    | 20   | 40   | 60   | 80   | 100  |
|-------------------|------|------|------|------|------|------|
| % $\text{BaCl}_2$ | 23.6 | 26.3 | 29.0 | 31.6 | 35.0 | 36.6 |

The enthalpy of fusion is  $193 \text{ kJ/kg}$ , and the entropy of fusion is  $87.7 \text{ Jkg}^{-1}\text{K}^{-1}$ . The heat capacity  $c_p$  is  $361.8 \text{ Jkg}^{-1}\text{K}^{-1}$  near room temperature.

Barium chloride crystallizes from aqueous solutions as the dihydrate in monoclinic colorless plates,  $\rho$   $3.097 \text{ g/cm}^3$ . Water of crystallization is not lost much before  $110^\circ\text{C}$ , this process being finished around  $160^\circ\text{C}$ .

**Production.** Today the production of barium chloride on an industrial scale is carried out by the reaction of 15–18% barium sulfide solution with 31–32% hydrochloric acid. In addition, the reaction of barium sulfide solution with chlorine is of commercial interest.

In both methods reaction is continued until the solution becomes acid to assure complete conversion of the barium sulfide and to remove from solution the hydrogen sulfide formed. The reaction with hydrochloric acid is often followed by oxidation with air or chlorine to convert any dissolved sulfur compounds into barium sulfate, which removes the sulfur from the solution. In both methods the solution is neutralized afterwards with barium carbonate or sodium hydroxide to precipitate heavy metals.

The solubility of  $\text{BaCl}_2$  in water does not depend strongly on temperature. If the barium chloride is to be crystallized, this is carried out by evaporative crystallization. In most cases vacuum evaporation is used, the salt crystallizing as the dihydrate. Normally it is only dried but it can be dehydrated further if necessary. The mother lye, which still contains barium chloride, can be processed to produce insoluble blanc fixe ( $\text{BaSO}_4$ ) or barium carbonate. The by-product hydrogen sulfide from the hydrochloric acid process is usually converted into sodium sulfide or sodium bisulfide.

In the chlorine process the by-product is sulfur, usually containing barium carbonate and heavy metals.

By-product barium chloride is obtained in the production of lithopone grades containing more than 30% zinc sulfide, for in these cases barium sulfide is reacted with zinc sulfate and zinc chloride. Another source of barium chloride is the black ash leaching residues. These are reacted with hydrochloric acid by some manufacturers. However, the resulting barium chloride solutions contain such a concentration of impurities that they must be purified extensively before further use.

The literature reports various procedures to convert barite directly into barium chloride. These procedures, e.g., the reaction of barite with carbon and calcium chloride or the chloridizing reduction of barite, no longer have significance in Western Europe or America, for they are now uneconomical. Direct conversion still seems to be of interest in Eastern Europe, where numerous scientific papers and patents on direct conversion are issued, e.g., [86]. The industrial production of barium chloride from barium sulfate, carbon, and calcium chloride is reported only from China.

**Quality Specifications, Packing, Shipping.** Both the dihydrate and anhydrous barium chloride are marketed as technical grades of 99–99.5%, the dihydrate also being available as a high-purity grade ( $\approx$  100%). They are packed in 50-kg multilayer paper bags with polyethylene covers or liners to make the bags

moistureproof. Shipment is governed by IMDG Class 6.1, UN 1564 (harmful, keep separate from foodstuffs), or RID/ADR Class 6.1, 71.

**Uses.** Along with other chlorides barium chloride is used as a component of melt quenching baths for steel. It is used as a starting material for the production of blanc fixe and, instead of barium carbonate, to remove sulfate from solutions. Finally, it has a limited importance as a stabilizer for plastics.

### 58.2.6 Barium Ferrite

Barium hexaferrite,  $\text{BaFe}_{12}\text{O}_{19}$ , forms hexagonal needle-shaped ferrimagnetic crystals. It is usually manufactured in a two-stage solid-state reaction, first stage at  $650$ – $750^\circ\text{C}$ , second stage  $> 850^\circ\text{C}$ . An intermediate is barium monoferrite,  $\text{BaFe}_2\text{O}_4$ .

### 58.2.7 Barium Oxide

Barium oxide, caustic baryta (an older term),  $\text{BaO}$ , *mp*  $\approx 1920^\circ\text{C}$ , sublimes  $\approx 2000^\circ\text{C}$ . Pure commercial barium oxide is a white fine crystalline powder, whereas technical grades are often gray due to carbon impurities. Barium oxide forms face-centered cubic crystals. The densities reported in the literature vary considerably, perhaps depending on preparation. The most likely value is  $\approx 5.7 \text{ g/cm}^3$ .

Usually barium oxide is very reactive. However, its reactivity depends on the preparative conditions, the reaction temperature, and the coreactant. In the absence of water  $\text{BaO}$  often reacts very slowly with carbon dioxide. In the presence of small amounts of water, however, it is converted by carbon dioxide into barium carbonate in a very exothermic reaction. The conversion of barium oxide by water into barium hydroxide is also very exothermic. Self-ignition may occur on contact with wet organic substances. Barium oxide is soluble in methanol: 20% dissolves at  $15^\circ\text{C}$ , and therefore barium oxide can be purified by recrystallization before it is used as a starting material for organic barium com-

pounds or for incorporation, as a methylate, into organic systems.

**Production.** Barium oxide is mainly produced by decomposition of barium carbonate in the presence of carbonaceous material at high temperature. The use of carbon significantly lowers the temperature at which the barium carbonate decomposes, which to a large extent avoids unwanted corrosion of the reactor when barium carbonate is decomposed by heat alone at 1400 °C. Also important is the decomposition of barium carbonate mixed with channel black (6.21% C) in retorts of silicon carbide–corundum externally heated to  $\approx$  1250 °C.

The modern procedures tend to use continuous fluidized beds. Barium carbonate-soot pellets are used [87, 88], or the carbon is added to the fluidized bed as methane [89]. The advantages are, among others, that the low reaction temperatures give less-sintered products, i.e., more reactive BaO.

There are also procedures using electrical arcs in a core zone [90]. In such processes a steep temperature drop is maintained between the hot core zone and the reactor shell, to provide a protective layer for the shell material. Addition of carbon is not absolutely necessary.

The crude barium oxide can be reacted [88, 89] in a second stage with carbon for more complete conversion.

The latest literature reports preparation of barium oxide by direct decomposition of barium sulfate or barium carbonate on a plasma torch, although production using this method has not been reported.

**Quality Specifications.** Barium oxide is marketed in grades of a purity of 97–99%. The main impurities are 1–3% barium carbonate,  $\leq$  1% barium peroxide, and a few tenths of a percent of nonconverted carbon.

**Storage and Shipping.** Barium oxide is shipped mainly in iron drums or, for smaller quantities, in tin cans. Shipment is governed by the regulations on the transport of harmful

goods of the IMDG Class 6.1, UN 1884, or RID/ADR Class 6.1, 71.

**Uses.** Barium oxide, like barium hydroxide, is mainly used for the preparation of additives for oils and greases; however, this is losing significance. In addition, barium oxide is used as a starting material for organic barium salts used in plastics. Barium oxide is frequently incorporated into fluorescent material, recently also into polyphenylene sulfide sealing pastes.

### 58.2.8 Barium Hydroxide

The anhydrous hydroxide has only a secondary industrial importance; the monohydrate and octahydrate are used in industry on a far larger scale.

**Properties.** Barium hydroxide octahydrate, hydrate of baryta, caustic baryta,  $\text{Ba}(\text{OH})_2 \cdot 8\text{H}_2\text{O}$ , forms monoclinic pseudotetragonal crystals, often plates when rapidly crystallized. It melts at 78 °C in its own water of crystallization, releasing the water when heated above 108 °C to yield the monohydrate. The density is  $\approx$  2.18 g/cm<sup>3</sup>. The specific heat capacity  $c_p$  of the solid is 1250 Jkg<sup>-1</sup>K<sup>-1</sup>, of the melt 1675 Jkg<sup>-1</sup>K<sup>-1</sup> at 80 °C.

The solubility in water depends on the temperature dramatically:

| °C   | 0   | 20   | 40   | 60   | 78    |
|--|-----|------|------|------|-------|
| % $\text{Ba}(\text{OH})_2 \cdot 8\text{H}_2\text{O}$ | 3.0 | 6.9  | 14.1 | 32.6 | 100.0 |
| g BaO/100 g H <sub>2</sub> O                         | 1.5 | 3.48 | 7.35 | 18.8 | 94.7  |

The solutions are strongly alkaline and tend to supersaturate.

Like all soluble hydroxides, barium hydroxide, especially in aqueous solution, reacts readily with acidic gases. The most important example in practice is carbon dioxide, to form barium carbonate.

Barium hydroxide monohydrate,  $\text{Ba}(\text{OH})_2 \cdot \text{H}_2\text{O}$ , crystallizes as often radially intergrown needles. Its density  $\rho_{20}$  is  $\approx$  3.74 g/cm<sup>3</sup>. The monohydrate does not react with dry carbon dioxide.

Anhydrous barium hydroxide,  $\text{Ba}(\text{OH})_2$ ,  $mp \approx$  407 °C. The course of the dehydration, i.e., the temperatures and times, from mono-

hydrate to anhydrous  $\text{Ba}(\text{OH})_2$  depends on the reactivity of the monohydrate. Molten anhydrous hydroxide is so corrosive, attacking steel and most ceramics, that the conversion of barium hydroxide into barium oxide, which takes place at 800 to 850 °C, is not carried out on an industrial scale.

**Production.** Barium hydroxide octahydrate is produced by hydration of barium oxide. The barium oxide is suspended in recycled mother lye and heated for several hours to destroy peroxides. The insolubles, e.g.,  $\text{BaCO}_3$ , are separated, and the hydroxide is precipitated by crystallization at low temperatures in stainless steel vessels. The crystals are removed from the mother lye by centrifugation.

Another industrial method is based on the oxidation of a barium sulfide solution [91–93]. Air is passed into the stirred solution containing barium hydroxide and barium hydrosulfide, the hydrolysis products of barium sulfide, until the hydrosulfide is oxidized to form polysulfide. Then the barium hydroxide octahydrate is crystallized at low temperatures and separated with a centrifuge. The polysulfidic mother lye is partly recycled, the rest usually processed for other barium compounds.

The monohydrate is generally produced on a commercial scale by dehydration of the octahydrate in heated vacuum driers. A monohydrate of especially high reactivity is obtained with drum driers [94]. This highly reactive monohydrate is particularly suitable for the production of oil additives.

**Storage, Packing, Shipping.** Both the monohydrate and the octahydrate are packed and stored in 50-kg polyethylene-lined multilayer paper bags. Shipping is governed by IMDG Class 6.1, UN 1564, or RID/ADR Class 6.1, 71.

**Uses.** Barium hydroxide, especially the monohydrate, is used to produce organic barium compounds such as additives for oil and stabilizers for plastics. In addition, barium hydroxide is used for dehydration and deacidification, especially for removing sulfu-

ric acid from fats, oils, waxes, and glycerol. In some applications, e.g., removal of sulfate from water and as starting material for other barium compounds, barium hydroxide to some extent replaces barium carbonate. The earlier use of the hydroxide in some countries for extracting the residual sucrose from molasses is no longer of much significance. The recent patent literature describes a procedure in which barium hydroxide is reacted with hydrogen peroxide to produce barium peroxide monohydrate [95].

### 58.2.9 Barium Nitrate

Barium nitrate,  $\text{Ba}(\text{NO}_3)_2$ ,  $mp$  593 °C, colorless cubic crystals, often octahedra,  $\rho_{20}$  3.24 g/cm<sup>3</sup>. The solubility of barium nitrate in water increases with temperature:

| °C                           | 0   | 10  | 20  | 50   | 100  |
|------------------------------|-----|-----|-----|------|------|
| % $\text{Ba}(\text{NO}_3)_2$ | 4.8 | 6.5 | 8.4 | 14.6 | 25.4 |

On heating, barium nitrate decomposes into barium oxide, barium peroxide, nitric oxide, nitrogen, and oxygen. The gaseous products formed and their proportions depend largely on the temperature and rate of heating [96]. The presence of sulfur or organic substances may cause an explosion.

For the production of barium nitrate various procedures are possible, starting from  $\text{BaCO}_3$ ,  $\text{Ba}(\text{OH})_2 \cdot 8\text{H}_2\text{O}$ , BaS, or  $\text{BaCl}_2$ . However, for industrial production there are two main procedures. In the first, barium carbonate is suspended in recycled mother lye and reacted with nitric acid. If necessary, heavy metals are precipitated, and the solution is filtered hot. The nitrate is then crystallized, if necessary with vacuum evaporation. The second procedure consists of reacting a barium sulfide solution, directly or after the removal of barium hydroxide, with nitric acid. After carefully removing any sulfur formed and the heavy metals, the barium nitrate is crystallized at low temperatures.

The preparation of  $\text{Ba}(\text{NO}_3)_2$  by double conversion of barium chloride and sodium nitrate or calcium nitrate is described in the Eastern European patent literature.

Barium nitrate is packed and stored in 50-kg polyethylene-lined multilayer paper bags. Shipping is governed by IMDG Class 5.1, UN 1446, or RID/ADR Class 5.1, 7c.

One of the main uses, a component in pyrotechnics to produce a green color, requires very pure barium nitrate, 99.5–99.8%. The content of other flame colorants — sodium, strontium, calcium — must be extremely low. Barium nitrate is used as a plaining agent in the manufacture of special glasses and optical glasses in place of the combination alkali-metal nitrate-arsenic. In addition it is used to incorporate barium oxide into catalysts, in luminescent cathode-ray screens, and as a component of metallurgical hardening agents.

### 58.2.10 Barium Titanate

Barium titanate,  $\text{BaTiO}_3$ ,  $m_p$  1625 °C,  $\epsilon_{20}$  6.02  $\text{g/cm}^3$ , has phase transitions and both ferroelectric and piezoelectric properties.

## 58.3 Toxicology

Water-soluble barium compounds are toxic, as is shown in Table 58.5. Most barium poisonings are caused by mistaking soluble barium compounds, such as barium carbonate, for the insoluble — and therefore nontoxic — barium sulfate, which is used as a contrast agent in X-ray diagnosis.

Table 58.5: Acute lethal doses of soluble barium compounds.

| Compound         | Toxicity  | Ref.  |
|------------------|---|-------|
| Barium carbonate | TDLo 29 mg/kg (human, oral)                     | [97]  |
| Barium nitrate   | LD <sub>50</sub> 8.5 mg/kg (mouse, i.v.)        | [98]  |
|                  | LD <sub>50</sub> 355 mg/kg (rat, oral)          | [99]  |
| Barium chloride  | LDLo 11.4 mg/kg (human, oral)                   | [100] |
| Barium oxide     | LD <sub>50</sub> 50 mg/kg (mouse, subcutaneous) | [101] |
| Barium fluoride  | LD <sub>50</sub> 250 mg/kg (rat, oral)          | [102] |

The symptoms of poisoning are convulsions of both striated and smooth muscles, including the heart, followed by paralysis of the peripheral nerve system. These effects on the nerve system are accompanied by severe inflammation of the gastrointestinal tract.

Barium carbonate is often used in the ceramics industry. Detailed examination of workers exposed to  $\text{BaCO}_3$  dust for 7–27 years did not reveal any specific chronic poisoning [103]. Damage to the lungs is often caused by contaminants in the barium compounds, such as quartz [104] or zinc sulfide [105]. However, it is possible that  $\text{BaSO}_4$  causes benign pneumoconiosis (barytosis) because, unlike  $\text{BaCO}_3$ ,  $\text{BaSO}_4$  is not absorbed by the organism [106, 107].

For soluble barium compounds an exposure limit of 0.5  $\text{mg/m}^3$  (as Ba) has been established by both TLV and MAK commissions (1983). According to the MAK, short-term exposure limits may be as high as 10  $\text{mg/m}^3$  (average over 30 min, four times within 8 h).

## 58.4 References

- Ullmann, 4th ed., vol. 8, p. 301.
- Gmelin, Barium (system no. 30), main volume, 1932; supplement volume, 1960.
- R. Fromageau, *Monogr. Mét. Haute Pureté* 1977, no. 2, 153–183.
- Kirk-Othmer, 3rd ed., vol. 3, pp. 457–463.
- R. D. Goodenough, V. A. Stenger: "Magnesium, Calcium, Strontium, Barium and Radium", in J. C. Bailar (ed.): *Comprehensive Inorganic Chemistry*, vol. 1, Pergamon Press, Oxford 1973, pp. 591–664.
- J. Alexander, M. Steffel: "Calcium, Strontium and Barium", in F. Korte (ed.): *Methodicum Chimicum*, vol. 7, Georg Thieme Verlag, Stuttgart 1976, pp. 97–106.
- Winnacker-Küchler, vol. 6: Metallurgie, pp. 81–107.
- C. L. Mantell: "Barium", in C. A. Hampel (ed.): *Rare Metals Handbook*, 2nd ed., Reinhold Publ. Co., London 1961, pp. 25–31.
- Römpps *Chemie-Lexikon*, 8th ed., vol. 1, Franckh'sche Verlagshandlung, Stuttgart 1979, p. 365.
- B. Mason: *Principles of Geochemistry*, J. Wiley & Sons, New York 1952, p. 41.
- H. Davy, *Nicholson's J.* 21 (Suppl. 1808) 366; 22 (1809) 54.
- J. W. Mallet, *Justus Liebigs Ann. Chem.* 190 (1878) 62.
- A. Guntz, *C.R. Hebd. Séances Acad. Sci.* 143 (1906) 339; *Ann. Chim. Phys.* 10 (1907) 441.
- J. Evers, A. Weiss, *J. Less Common Met.* 30 (1973) 83.
- E. Miller et al., *Trans. Metall. Soc. AIME* 218 (1960) 978.
- P. Ehrlich, H. J. Seifert in G. Brauer (ed.): *Handbuch der Präparativen Anorg. Chemie*, vol. 2, Enke Verlag, Stuttgart 1978, pp. 917–934.
- K. E. Maas, *Z. Anorg. Allg. Chem.* 374 (1970) 1.

- R. Schmid: "Nitride der Hauptgruppenmetalle", in F. Korte (ed.): *Methodicum Chimicum*, vol. 7, Georg Thieme Verlag, Stuttgart 1976, pp. 59–62.
- I. Obinata et al., *Metall (Berlin)* 19 (1965) 21; also see [6] and the literature cited there.
- J. J. Alexander: "Carbide der Elemente der 1.–4. Hauptgruppe", in F. Korte (ed.): *Methodicum Chimicum*, vol. 7, Georg Thieme Verlag, Stuttgart 1976, p. 67.
- W. Biltz, G. Hüttig, *Z. Anorg. Allg. Chem.* 114 (1920) 241.
- R. Juza, H. Schuhmacher, *Z. Anorg. Allg. Chem.* 324 (1963) 278.
- Houben-Weyl, 13 (2a), 542–543.
- W. Lindsell in G. Wilkinson (ed.): *Comprehensive Organometallic Chemistry*, vol. 1, Pergamon Press, Oxford 1982, pp. 223–252.
- M. Hansen: *Constitution of Binary Alloys*, McGraw-Hill, New York 1958; 1st Supplement, R. P. Elliott (ed.), New York 1965; 2nd Supplement, F. A. Shunk (ed.), New York 1969.
- H. Seliger, *Freiberg. Forschungsh.* B 34 (1959) 80.
- J. Krüger in O. Winkler, R. Bakish (eds.): *Vacuum Metallurgy*, Elsevier, Amsterdam 1971, pp. 207–212.
- I. S. Bystrova et al., *Proizvod. Ferrosplavov* 1977, no. 5, 31–37; *Chem. Abstr.* 87 (1977) 120951.
- O. Orman, E. Zembala, *Pr. Inst. Hutn.* 4 (1952) 437.
- E. Fujita, H. Yokomizo, *Tokyo Kogyo Shikensho Hokoku* 47 (1952) 291.
- P. S. Danner, *J. Am. Chem. Soc.* 46 (1924) 2382.
- J. Evers, G. Oehlinger, A. Weiss, *J. Less Common Met.* 81 (1981) 15.
- C. Matignon, *C.R. Hebd. Séances Acad. Sci.* 156 (1913) 1378.
- W. Sundermeyer, *Angew. Chem.* 77 (1965) 245.
- Ges. Deutscher Metallhütten- und Bergleute: *Analyse der Metalle*, 2nd ed., vol. II/1, Springer Verlag, Berlin 1961, pp. 139–145.
- L. Edelbeck, P. W. West, *Anal. Chim. Acta* 52 (1970) 447.
- Degussa, Geschäftsbereich Technische Metallzeugnisse, Lieferprogramm Sondermetalle, Hanau, Germany.
- G. Tölg, *Fresenius Z. Anal. Chem.* 294 (1979) 1; also see [27], pp. 22–23.
- L. Melnick, L. Lewis, B. Holt (eds.): "Determination of Gaseous Elements in Metals", *Monographs on Analytical Chemistry*, vol. 40, J. Wiley & Sons, New York 1974.
- IMDG, Class 4.3, p. 4147; UN 1400; 4.3/IA RID, ADR, GGVS, GGVE.
- I. Sax (ed.): *Dangerous Properties of Industrial Materials*, 4th ed., Van Nostrand Reinhold Co., New York 1975, p. 430.
- S. Wagener, *Z. Angew. Phys.* 6 (1954) 433.
- J. Maley, J. Moscony, *J. Vac. Sci. Technol.* 6 (1969) 51.
- K. Marquard, *Residual Gases Electron Tubes Proc. Int. Conf. 4th 1971*, 315–334; *Chem. Abstr.* 77 (1972) 106–735.
- M. Malev, *Vacuum* 23 (1973) 359.
- J. Turnbull, *J. Vac. Sci. Technol.* 14 (1977) 636.
- U.S.-Philips Corp., US 4077899, 1978; *Chem. Abstr.* 88 (1978) 181336.
- A. Misumi et al., *Shinku* 23 (1980) 183; *Chem. Abstr.* 93 (1980) 178254.
- Phillips Electronic, GB 1182883, 1970; *Chem. Abstr.* 72 (1970) 115999.
- P. Ward, *J. Illum. Eng. Soc.* 9 (1980) 194; *Chem. Abstr.* 93 (1980) 190370.
- W. Cowan et al., *Trans. Am. Electrochem. Soc.* 40 (1921) 27.
- P. Paschen et al., *Metall (Berlin)* 23 (1969) 786.
- D. Randolph, *Trans. Electrochem. Soc.* 66 (1934) 85.
- Union Carbide Corp., US 3734714, 1973.
- V. Nikolaev, V. Vasilev, *Liteinoe Proizvod.* 1980, no. 4, 6; *Chem. Abstr.* 93 (1980) 135988.
- V. D. Povolotskii et al., *Izv. Vyssh. Uchebn. Zaved. Chern. Metall.* 10 (1982) 69; *Met. Abstr.* 16 (1983) 45-0527.
- Z. Zhou et al., *Gießerei Prax.* 1983, no. 4, 49–52.
- K. Adam, *Metall (Berlin)* 37 (1983) 733.
- P. Münster, G. Kirchner: *Taschenbuch des Metallhandels*, 7th ed., Metall-Verlag GmbH, Berlin 1982, pp. 148–149.
- E. Sibbing: "Schwerspat: Rohstoffbasis für Fullstoffe und Bariumchemikalien", part 1, *Kunstst. J.* 8 (1974) no. 10, 30–36.
- E. Sibbing: "Schwerspat: Rohstoffbasis für Fullstoffe und Bariumchemikalien", part 2, *Kunstst. J.* 8 (1974) no. 11, 26–31.
- Barytes — Its Uses Outside Drilling Muds, *Ind. Miner. (London)* 1978, no. 133, 33–43.
- J. Massonne: "Technology and Uses of Barium and Strontium Compounds", *Ind. Miner. (London)* 1982, no. 177, 65–69.
- D. Rohe: "Nicht nur Masse, sondern auch Qualität durch mineralische Fullstoffe, part III: Sulfate", *Chem. Ind. (Düsseldorf)* 35 (1983) 369–373.
- Gmelin, Barium (system no. 30), main volume, 1932; supplement volume, 1960.
- M. Clement, H. Surmatz, H. Hüttenhain, *Z. Erzbergbau Metallhüttenwes.* 20 (1967) 512–522.
- Klöckner Humboldt-Deutz, DE-OS 1783014, 1968.
- Oil Companies Material Association (OCMA): Specification No. DFCP 3, Cecil Chambers, London 1973.
- American Petroleum Institute (API): *API RP 13B*, 6th ed., Washington, DC, 1976.
- K.-H. Grodde: *Bohrspülungen und Zementschlämme in der Tiefbohrtechnik*, Verlag O. Vieth, Hamburg 1963.
- Sachtleben, DE-OS 1955881, 1969.
- Sachtleben, DE 567348, 1930.
- Titan Co., GB 427220, 1933.
- R. Maiwald, Dissertation 1977, Bergakademie Freiberg.
- A. A. Rawdel, N. A. Nowikowa, *Zh. Prikl. Khim. (Leningrad)* 36 (1963) 1433–1442.
- Forschungsinstitut für NE-Metalle, DE-OS 1567512, 1965.
- G. Salvi, A. Fiumara, *Riv. Combust.* 12 (1958) 525–561.
- N. S. Safiullin, S. F. Gawrilowa, *Khim. Promst. (Kiev)* 1965, no. 3, 32–35.
- Kali-Chemie, DE-OS 2034065, 1970.
- Kali-Chemie, DE 1800866, 1968.
- E. H. Baker, *J. Chem. Soc.* 1964, 699–704.

81. M. M. Evstigneeva, A. A. Bundel, B. V. Kondakov, *Tr. Mosk. Khim. Tekhnol. Inst. im. D. I. Mendeleeva* 62 (1969) 291-294; *Zh. Fiz. Khim.* 43 (1969) 2613-2614; 44 (1970) 2607-2609.
82. A. Schulze, DD 58501, 1966.
83. Kali-Chemie, DE 1907440, 1969.
84. A. Schulze, DD 45070, 1964.
85. PPG Industries, US 3467494, 1966.
86. A. F. Lozhkin, SU 245047, 1967.
87. Columbia Southern Chem., US 2772948, 1952.
88. Columbia Southern Chem., US 2772949, 1952.
89. Columbia Southern Chem., US 2915366, 1956.
90. FMC, US 3031266, 1959.
91. IG Farbenind., DE 519891, 1929.
92. IG Farbenind., DE 526796, 1930.
93. Kali-Chemie, DE 1792505, 1968.
94. FMC, DE 1186841, 1962.
95. Peroxid-Chemie, DE-OS 203063, 1983.
96. F. Lazarini, B. S. Brčić, *Monatsh. Chem.* 97 (1966) 1318.
97. *Israel J. Med. Sci.* 3 (1967) 565.
98. *Toxicol. Appl. Pharmacol.* 22 (1982) 150.
99. J. V. Marhold: *Sbornik Výsledků Toxikologického Výšetření Latek a Přípravků*, Institut Pro Vychovu Veducin Pracovníku Chemického Průmyslu, Praha 1972, p. 10.
100. T. Sollmann (ed.): *Manual of Pharmacology and its Applications to Therapeutics and Toxicology*, 7th ed., Saunders, Philadelphia 1942, p. 478.
101. *Zh. Vses. Khim. Ova.* 19 (1974) 186.
102. *Vestn. Akad. Med. Nauk SSSR* 32 (1977) 28.
103. H.-G. Essing, G. Bühlmeyer, G. Kemmerer, R. Procharka, *Arbeitsmed. Sozialmed. Präventivmed.* 11 (1976) no. 12, 299-302.
104. E. Browning: *Toxicity of Industrial Metals*, 2nd ed., Butterworths, London 1965.
105. E. Wende, *Arch. Gewerbepathol. Gewerbehyg.* 15 (1956) 171.
106. Z. Maretič, *Med. Klin. (München)* 52 (1957) 1950-1953.
107. E. P. Pendergrass, R. R. Gruning, *Arch. Ind. Hyg. Occup. Med.* 7 (1959) 44-48.

## Authors

### Jörg Adel

● §§ 15.12.1-15.12.4  
BASF Aktiengesellschaft  
EPM/EE, H 201  
67056 Ludwigshafen  
Germany

### Gerhard Adrian (retired)

● § 27.7.4.1  
● §§ 46.10.2.1-46.10.2.4  
Dr. Hans Heubach GmbH & Co. KG  
Postfach 1160  
38679 Langelsheim  
Germany

### Fritz Aldinger

● Chapter 19  
Leybold-Heraeus GmbH  
Wilhelm-Rohn-Straße 25  
63450 Hanau  
Germany

### Peter Ambatiello

● § 51.13.3.2  
Südsalz GmbH  
Salzbergwerk Berchtesgaden  
Bergwerkstraße 83  
83471 Berchtesgaden  
Germany

### Klaus Andersson

● Chapter 29  
H.C. Starck GmbH & Co. KG  
Werk Goslar  
Postfach 2540  
38615 Goslar  
Germany

### Knut Andreassen

● §§ 20.1-20.10  
Norsk Hydro a.s  
P.O. Box 2594, Solli  
N-0203 Oslo 2  
Norway

### Gerd Anger †

● § 46.4  
Bayer AG

GB-SP-Chrom, Geb. T18  
51368 Leverkusen  
Germany

### Terje Kr. Aune

● §§ 20.1-20.10  
Norsk Hydro a.s  
P.O. Box 2594, Solli  
N-0203 Oslo 2  
Norway

### Ulrich Baudis

● § 49.1 except 49.1.1  
● § 58.1  
Durferrit GmbH  
Degussa ZN Wolfgang  
Rodenbacher Chaussee 4  
63457 Hanau  
Germany

### Günter Bauer (retired)

● § 7.12  
● Chapter 32  
● §§ 52.4.1-52.4.2.2  
Kali und Salz AG  
Friedrich-Ebert-Str. 160  
34119 Kassel  
Germany

### Richard Bauer

● Chapter 50  
Anemonenstraße 10  
83346 Bergen  
Germany

### T. Bauer

● § 51.13.1  
Solvay Alkali GmbH  
Postfach 10 13 61  
47493 Rheinberg  
Germany

### Leopold Benda

● § 48.7.3  
Niedersächs. Landesamt f. Bodenf.  
Postfach 51 01 53  
30631 Hannover  
Germany

**Gerhard Berger**

● § 16.12  
 BASF Lacke + Farben AG  
 Pigmente und Hilfsmittel  
 Postfach 1163  
 74354 Besigheim  
 Germany

**Horacio E. Bergna**

● § 48.7.4  
 The Du Pont Company  
 Du Pont Experimental Station  
 P.O. Box 80262  
 Wilmington, DE 19880-0262  
 USA

**Udo Bertmann**

● § 5.22.7  
 DMT-Gesellschaft für Forschung und Prüfung mbH  
 Franz-Fischer-Weg 61  
 45307 Essen  
 Germany

**Robert Besold**

● § 8.12  
 ● § 10.9.8  
 ● § 21.11.3  
 Carl Schlenk AG  
 Postfach 4548  
 90024 Nürnberg  
 Germany

**Manfred Bick**

● Chapter 54  
 Chemetall GmbH  
 Reuterweg 14  
 60323 Frankfurt  
 Germany

**Christian Boidart**

● § 51.13.3.4  
 CIE Salins du Midi et Salines de l'Est  
 68, Cours Gambetta  
 F-34063 Montpellier Cedex 4  
 France

**Bernhard Bonn**

● § 5.22.7  
 DMT-Gesellschaft für Forschung und Prüfung mbH  
 Franz-Fischer-Weg 61  
 45307 Essen  
 Germany

**Thomas B. Bonney**

● § 21.8  
 Aluminum Company of America  
 Alcoa Technical Center  
 Alcoa Center, PA 15069  
 USA

**Karl Brandt**

● § 27.7.4.1  
 ● §§ 46.10.2.1–46.10.2.4  
 Dr. Hans Heubach GmbH & Co. KG  
 Postfach 1160  
 38679 Langelsheim  
 Germany

**Robert J. Brotherton**

● §§ 49.2–49.3  
 U.S. Borax Research Corp.  
 Chemical Research  
 412 Crescent Way  
 Anaheim, CA 92801  
 USA

**Volker Brückmann**

● § 6.8  
 Wirtschaftsvereinigung Stahl  
 Postfach 10 54 64  
 40045 Düsseldorf  
 Germany

**Jörg Brüning**

● § 52.1–52.2, 52.5–52.10  
 Callery Chemical Company  
 P.O. Box 429  
 Pittsburgh, PA 15230  
 USA

**Heinz-Lothar Bünningel**

● § 5.13  
 ● § 6.8  
 Wirtschaftsvereinigung Stahl  
 Postfach 10 54 64  
 40045 Düsseldorf  
 Germany

**Andreas Buhr**

● § 5.7  
 Krupp Hoesch Stahl AG  
 Abt. 20 GWT-STP Feuerfeste Stoffe  
 44120 Dortmund  
 Germany

**Elizabeth R. Burkhardt**

● §§ 52.1–52.2, 52.5–52.10  
 Callery Chemical Company  
 P.O. Box 429  
 Pittsburgh, PA 15230  
 USA

**Alfred Richard Burkin**

● §§ 27.2–27.3, 27.8  
 Dept. of Mineral Resources Eng.  
 Imperial College  
 Prince Consort Rd.  
 London, SW7 2AZ  
 England

**Gunter Buxbaum**

● § 5.21.1  
 Bayer AG  
 Werk Uerdingen, R & G  
 Postfach 166  
 47812 Krefeld  
 Germany

**Dodd S. Carr**

● § 9.13  
 Int. Lead Zinc Res. Organization  
 P.O. Box 12036  
 Research Triangle Park, NC 27709-2036  
 USA

**Douglas A. Church**

● § 27.9  
 Climax Metals Co.  
 Amax Center  
 Greenwich, CT 06836-1700  
 USA

**Bernard Clercx**

● § 51.13.3.3  
 Salzgewinnungsgesellschaft Westfalen mbH  
 Graeser Brook 9  
 48683 Ahaus  
 Germany

**Joseph A. Corella**

● §§ 49.4–49.5  
 Callery Chemical Co.  
 P.O. Box 429  
 Pittsburgh, PA 15230  
 USA

**William Brian Cork**

● § 21.11.1

155 Newland Park  
 Hull  
 North Humberside HU5 2DX  
 England

**Peter M. Craven**

● § 7.4  
 ● §§ 47.1–47.9  
 Samancor House  
 88 Marshall St.  
 Johannesburg 2001  
 Republic of South Africa

**John C. Crelling**

● §§ 5.22.1–5.22.4, 5.22.9–5.22.11  
 Department of Geology  
 Southern Illinois University  
 Carbondale, IL 62901  
 USA

**Winfried Dahl**

● § 6.6.3  
 RWTH Aachen  
 Institut für Eisenhüttenkunde  
 Intzestraße 1  
 52072 Aachen  
 Germany

**Max Danner**

● §§ 21.10.5.2–21.10.5.3, 21.10.6  
 Hoechst Aktiengesellschaft  
 Werk Gersthofen  
 -Chemikalien-  
 86368 Gersthofen  
 Germany

**Max Dauderer**

● § 17.14  
 Kreuzeckstraße 9  
 82049 Pullach  
 Germany

**Robert K. Dawless**

● § 21.5  
 Aluminum Company of America  
 Alcoa Technical Center  
 Alcoa Center, PA 15069  
 USA

**Paul D. Deeley**

● § 46.8  
 Paul Deeley & Associates  
 27 Lonesome Pine Trail



Yalaha, FL 34797-3060  
USA

### Herbert Diskowski

● § 7.7  
Fasanenaue 4  
50374 Erfstadt  
Germany

### John Dallas Donaldson

● §§ 18.1–18.11  
Brunel University  
Dept. of Chemistry  
Uxbridge, Middx UB8 3PH  
England

### Robert R. Dorfler

● §§ 27.4.1–27.4.4  
Cyprus Minerals Company  
Green Valley, AZ 85622  
USA

### James H. Downing

● §§ 46.1–46.7  
Elkem Metals Company  
P.O. Box 1344  
Niagara Falls, NY 14302  
USA

### Franz Ludwig Ebenhöch (retired)

● § 5.17.6  
Philipp-Stempel-Straße 9  
67069 Ludwigshafen  
Germany

### Joachim Eckert

● § 7.10  
● Chapter 28  
H. C. Starck GmbH & Co. KG  
Postfach 2540  
38615 Goslar  
Germany

### Ralf Emmert

● § 5.21.5  
● § 9.14.5  
● § 15.12.5  
● § 22.7.11  
Rona  
Bayonne, NJ 07002  
USA

### Hartmut Endriß

● § 16.12  
BASF Aktiengesellschaft  
–EPM/TP, J 550-  
67056 Ludwigshafen  
Germany

### Bernard Epron

● § 51.13.3.4  
Compagnie des Salins du Midi et des Salines de l'Est  
Dép. Coopération technique  
53, Rue des Mathurins  
F-75008 Paris  
France

### Semih Eser

● § 5.22.13  
404 Academic Activities Bldg.  
The Pennsylvania State Univ.  
University Park, PA 16802  
USA

### Manfred Ettlinger

● § 48.7.6  
Degussa AG  
-AC-KS-AT/AE-  
Postfach 1345  
63403 Hanau  
Germany

### Günter Etzrodt

● § 5.21.4  
● §§ 9.14.1–9.14.4  
● §§ 10.9.2.8, 10.9.3–10.9.7  
● § 21.11.2  
● § 27.7.4.2  
● §§ 46.10.2.5, 46.10.4  
● § 49.14  
BASF Aktiengesellschaft  
–EPM/KK - J 550-  
67056 Ludwigshafen  
Germany

### Harald Fabian †

● §§ 8.1–8.10  
Buchholzer Weg 1a  
21079 Hamburg  
Germany

### Noël Felix

● Chapter 36  
Metallurgie Hoboken-Overpelt  
R + D Department

A. Greinerstraat 14  
B-2710 Hoboken  
Belgium

### Horst Ferch

● § 5.21.2  
Justus-Liebig-Straße 13  
63486 Bruchköbel  
Germany

### Rudolf Fichte

● §§ 7.1, 7.5, 7.9  
Karl-Giermann-Straße 14  
90473 Nürnberg  
Germany

### Wilhelm Flick

● § 20.11.3.5  
An der Wielermaar 16  
51143 Köln  
Germany

### Jürgen Flickenschild

● § 5.11  
Deutsche Voest-Alpine  
Industrieanlagen GmbH  
Postfach 26 01 52  
40094 Düsseldorf  
Germany

### Otto W. Flörke

● §§ 48.7.1–48.7.2  
Wagenfeldstraße 11  
58456 Witten  
Germany

### Peter Forgione

● § 56.8  
120 Little Hill Dr.  
Stamford, CT 06905  
USA

### Lothar Formanek

● § 5.10 except 5.10.1  
Lurgi Metallurgie GmbH  
Lurgiallee 5  
60295 Frankfurt/Main  
Germany

### William B. Frank

● §§ 21.1–21.9  
Aluminum Company of America

Alcoa Technical Center  
Alcoa Center, PA 15069  
USA

### Klaus-Dieter Franz

● § 5.21.5  
● § 9.14.5  
● § 15.12.5  
● § 22.7.11  
E. Merck KGaA  
Abt. PK FO PE  
Frankfurter Straße 250  
64271 Darmstadt  
Germany

### Gabriele Friedrich

● § 5.17.6  
BASF Aktiengesellschaft  
ZAA-A, M300  
67056 Ludwigshafen  
Germany

### Harald Gaedcke

● §§ 5.21.6–5.21.7  
● § 10.9.2.9  
● § 18.12  
● § 22.7.12  
BASF Aktiengesellschaft  
Lacke und Farben AG  
Gustav-Siegle Straße 19  
74354 Besigheim  
Germany

### Wolfgang Gatzka

● § 5.22.12  
Bredeneyer Straße 141  
45133 Essen  
Germany

### Rolf Gerstenberg

● §§ 57.3–57.6, 57.8  
Solvay Barium Strontium GmbH  
Postfach 220  
30002 Hannover  
Germany

### Helmut Geyer

● § 51.13.3.3  
Schelverweg 13  
48599 Gronau-Epe  
Germany

**Hermann Gies**

- § 48.7.8
- Ruhr-Universität Bochum  
Institut für Mineralogie  
Postfach 10 21 48  
44780 Bochum  
Germany

**James C. Gilliland (retired)**

- §§ 27.10–27.11
- Amax Mineral Resources Co.  
1626 Cole Boulevard  
Golden, CO 80401-3293  
USA

**Hans-Jürgen Grabke**

- § 6.6.2
- Max-Planck-Institut für Eisenforschung GmbH  
Abt. Physikalische Chemie  
Postfach 14 04 44  
40074 Düsseldorf  
Germany

**Günter G. Graf**

- §§ 10.1–10.6
  - Chapter 11
- Schulweg 17b  
09599 Freiberg/Sachsen  
Germany

**Douglas A. Granger**

- § 21.6
- Aluminum Company of America  
Alcoa Technical Center  
Alcoa Center, PA 15069  
USA

**Jörg Friedrich Greber**

- §§ 35.1–35.9
- Am Weingarten 16  
38154 Königslutter  
Germany

**Jürgen Griebel**

- § 40.5
- Forschungsz. f. Umwelt u. Gesund  
(GSF) Inst. f. Strahlenbiologie  
Ingolstädter Landstraße 1  
91465 Ergersheim  
Germany

**Wolf-Dieter Griebler**

- § 10.9.1

Sachtleben Chemie GmbH  
Dr.-Rudolf-Sachtleben-Straße 4  
47198 Duisberg  
Germany

**Horst Großman**

- §§ 13.1–13.9
- Rosa-Luxemburg-Straße 14  
44534 Lünen  
Germany

**Clarence Guibert**

- §§ 49.4–49.5
- Callery Chemical Co.  
P.O. Box 429  
Pittsburgh, PA 15230  
USA

**Volker Güther**

- §§ 7.11–7.12
  - Chapter 32
- Gesellschaft für Elektrometallurgie  
Postfach 2844  
90013 Nürnberg  
Germany

**Fathi Habashi**

- Chapters 1–4
  - §§ 5.1, 5.2, 5.4–5.6 except 5.5.6–5.5.11, 5.8–5.9, 5.14–5.16, 5.17.1, 5.18–5.19
  - § 7.2 (introductory paragraph)
  - § 8.11.3.4
  - § 22.13
  - § 34.12
  - § 35.10
- Laval University  
Department of Mining and Metallurgy  
Sainte-Foy, Québec  
G1K 7P4  
Canada

**Fritz Hagedorn**

- §§ 52.11.3, 52.11.7
- Kali und Salz AG  
Friedrich-Ebert-Str. 160  
34119 Kassel  
Germany

**Fred W. Hall**

- § 7.2 (except introductory paragraph)
- 537 Fulwood Road  
Sheffield S10 3QG  
South Yorkshire

England

**Jost Halstenberg**

- §§ 46.9.1–46.9.6 except 46.9.2.2; 46.9.10
- Bayer AG  
-GB-SP-Chrom, Geb. T18-  
51368 Leverkusen  
Germany

**Rudolf Hammer †**

- §§ 6.3.5.1–6.3.5.3
- Im Kirchbruch 23  
46535 Dinslaken  
Germany

**Kunibert Hanusch**

- §§ 13.1–13.9
  - §§ 14.1–14.10, 14.12–14.13
- Hüttenwerke Kayser AG  
Kupferstraße 23  
44532 Lünen  
Germany

**Gabriele Hartmann**

- §§ 51.1–51.12
- Degussa AG  
Werk Wesseling  
Postfach 1164  
50375 Wesseling  
Germany

**Hartmut Härtner**

- § 5.21.5
  - § 9.14.5
  - § 15.12.5
  - § 22.7.11
- E. Merck  
-Pigment-Sparte-  
Frankfurter Straße 250  
64271 Darmstadt  
Germany

**Turid Haugerød**

- §§ 20.1–20.10
- Norsk Hydro a.s  
P.O. Box 2594, Solli  
N-0203 Oslo 2  
Norway

**Rolf Hauk**

- § 5.11
- Deutsche Voest-Alpine  
Industrieanlagen GmbH

Postfach 26 01 52  
40094 Düsseldorf  
Germany

**Warren E. Haupin**

- §§ 21.1–21.9
- Aluminum Company of America  
Alcoa Technical Center  
Alcoa Center, PA 15069  
USA

**Otto Helmboldt**

- §§ 21.10.2–21.10.3
- Giulini Chemie GmbH & Co. OHG  
Postfach 15 04 80  
67029 Ludwigshafen  
Germany

**Robert Hentrich**

- § 6.3.5.4
- Thymianweg 10  
57078 Siegen  
Germany

**Karl-Albert Herbst**

- §§ 13.1–13.9
  - §§ 14.1–14.10, 14.12–14.13
- Rosa-Luxemburg-Straße 14  
44534 Lünen  
Germany

**Wolfgang Herde**

- § 51.13.2
- Husarenweg 11  
38272 Burgdorf  
Germany

**Hans Hess**

- § 7.12
  - Chapter 32
- Gesellschaft für Elektrometallurgie mbH  
Postfach 2844  
90013 Nürnberg  
Germany

**Stephen Hluchan**

- §§ 56.1–56.4
- Speciality Minerals Inc.  
The Chrysler Building  
405 Lexington Avenue  
New York, NY 10174-1901  
USA

**Klaus Hochgeschwender**

● §§ 46.9.7–46.9.9  
Bayer AG  
AI-S/öK + Si, Geb. 01  
51368 Leverkusen  
Germany

**Hans-Georg Hoff**

● § 5.13  
Wirtschaftsvereinigung Stahl  
Postfach 10 54 64  
40045 Düsseldorf  
Germany

**Hans Hougardy**

● § 6.6.1  
Max-Planck-Institut für Eisenforschung GmbH  
Postfach 14 04 44  
40074 Düsseldorf  
Germany

**Nils Ove Høy-Petersen †**

● §§ 20.1–20.10  
Norsk Hydro a.s.  
P.O. Box 2594, Solli  
N-0203 Oslo 2  
Norway

**L. Keith Hudson (retired)**

● §§ 21.10.1, 21.10.3.1  
Aluminum Company of America  
Corporate Research & Development  
Alcoa Technical Center  
Alcoa Center, PA 15069  
USA

**Hatto Jacobi**

● §§ 6.3.5.1–6.3.5.3  
Mannesmannröhrenwerke AG  
Mannesmann Forschungsinstitut  
Postfach 25 11 67  
47251 Duisburg  
Germany

**Paul Jäger**

● § 58.2  
Kali-Chemie AG  
Hauptverwaltung, C-AF  
Postfach 220  
30002 Hannover  
Germany

**Helmut Jakusch**

● § 5.21.3.4  
● § 46.10.3  
BASF Aktiengesellschaft  
-EPR/P, J653-  
67056 Ludwigshafen  
Germany

**Robert James**

● § 21.9  
Aluminum Company of America  
Alcoa Technical Center  
Alcoa Center, PA 15069  
USA

**Dieter Janke**

● § 6.3.2  
TU Bergakademie Freiberg  
Institut für Eisen- und Stahltechnologie  
09596 Freiberg  
Germany

**José Jiménez**

● § 55.9  
Geisenheimer Straße 90  
60529 Frankfurt  
Germany

**Heinrich J. Johnen †**

● § 10.7  
Bruchweg 38  
41564 Kaarst  
Germany

**Mark W. Johns**

● § 23.4.3  
MINTEK  
Privat Box X3015  
Randburg 2125 TVL  
Republic of South Africa

**Peter Jönk (retired)**

● § 17.11  
Rosenstraße 4  
63480 Roßdorf  
Germany

**Sigurd Jönsson**

● Chapter 19  
Leybold-Heraeus GmbH  
Wilhelm-Rohn-Straße 25  
63450 Hanau  
Germany

**Hendrik Kathrein**

● §§ 5.21.3.1–5.21.3.3  
Bayer Corp.  
Industrial Chemicals Division  
100 Bayer Road  
Pittsburgh, PA 15205-9741  
USA

**Suzanne E. Keegan**

● § 56.7  
Allied Corporation  
P.O. Box 6  
Solvay, NY 13209  
USA

**Cornelius Keller †**

● § 40.4  
Kernforschungszentrum Karlsruhe  
Schule für Kerntechnik  
Postfach 3640  
76021 Karlsruhe  
Germany

**Albrecht M. Kellerer**

● § 40.5  
Forschungsz. f. Umwelt u. Gesund  
(GSF) Inst. f. Strahlenbiologie  
Ingolstädter Landstraße 1  
85758 Oberschleißheim  
Germany

**Robert Kemp**

● § 56.7  
Allied Corporation  
P.O. Box 6  
Solvay, NY 13209  
USA

**Robert C. Kerby**

● §§ 9.6.2, 9.11  
General Manager R + D  
Cominco Ltd.  
Trail  
British Columbia VIR 4L8  
Canada

**Derek G. E. Kerfoot**

● § 7.6  
● §§ 12.1–12.15  
Sherritt International Corporation  
P.O. Box 3388  
Fort Saskatchewan, Alberta T8L 2P2  
Canada

**Dieter Kerner**

● § 48.7.7  
Degussa Corp.  
65 Challenger Road  
Ridgefield Park, NJ 07660  
USA

**M. Rashid Khan**

● § 5.22.13  
U.S. Dept. of Energy  
Morgantown Energy Tech. Center  
Morgantown, WV 26505  
USA

**Peter Kleinschmit**

● § 48.7.7  
Degussa AG  
Kieselsäuren und Chemiekatal.  
Forschung u. Anwendungstechnik  
Postfach 1345  
63403 Hanau  
Germany

**Alfred Klemm**

● §§ 51.1–51.12  
Max Planck Institut für Chemie  
Otto Hahn Institut  
Beuthener Straße 25  
55131 Mainz  
Germany

**Guy Knockaert**

● Chapter 39  
UM-Ge & Special Metals  
A.Greinerstraat 14  
B-2660 Hoboken  
Belgium

**Herbert Knopf**

● §§ 46.9.1–46.9.5 except 46.9.2.2; 46.9.10  
Bertha-von-Suttner-Straße  
51373 Leverkusen  
Germany

**Lothar Koch**

● Chapter 43  
Institute for Transuranium Elements  
Nuclear Chemistry  
P.O. Box 2340  
76125 Karlsruhe  
Germany

**Karl Köhler**

- §§ 57.3–57.6, 57.8
- Solvay Barium Strontium GmbH  
Postfach 220  
30002 Hannover  
Germany

**Manfred Koltermann**

- § 5.7
- Krupp Hoesch Stahl AG  
Abt. 20 GWT-STP Feuerfeste Stoffe  
44120 Dortmund  
Germany

**Morgan Kommer**

- § 21.7
- Aluminum Company of America  
Alcoa Technical Center  
Alcoa Center, PA 15069  
USA

**Ulrich Korallus (retired)**

- § 46.9.11
- Walter-Flex-Straße 25  
51373 Leverkusen  
Germany

**Ulrich Kowalski**

- § 51.13.5
- Südsalz-Vertriebs GmbH  
Postfach 1254  
74174 Bad Friedrichshall  
Germany

**Gerhard Kristen**

- § 51.13.1
- Solvay Alkali GmbH  
Postfach 10 13 61  
47493 Rheinberg  
Germany

**Joachim Krüger**

- §§ 15.1–15.10
- RWTH Aachen  
Institut für Metallhüttenwesen und Elektrometallurgie  
52056 Aachen  
Germany

**Lothar Kucharcik**

- § 6.3.5.5
- Am Kothen 7  
40822 Mettmann  
Germany

**Brigitte Kühborth**

- § 5.17.6 (Toxicology and Occupational Health)
- BASF Aktiengesellschaft  
Toxikologie ZST, Geb. 470  
67056 Ludwigshafen  
Germany

**John M. Laferty (retired)**

- §§ 27.4.1–27.4.4
- Climax Molybdenum Company  
Wheatridge, CO 80033  
USA

**Ludwig Lange**

- §§ 51.1–51.12
  - §§ 55.1–55.8
- Degussa AG  
Abt. USAN  
Postfach 11 05 33  
60287 Frankfurt  
Germany

**Bernd E. Langner**

- Chapter 38
- Norddeutsche Affinerie AG  
Forschung und Entwicklung  
Hoverstraße 50  
20539 Hamburg  
Germany

**Keith Lascelles**

- §§ 12.17 except 12.17.2 and 12.17.5
- INCO Europe Ltd.  
Clydach, Swansea SA6 5QR  
Wales  
Great Britain

**Erik Lassner**

- §§ 26.1, 26.2.2, 26.3–26.11
- Grazerstraße 34 C  
A-8045 Graz  
Austria

**Gerhard Leichtfried**

- §§ 27.4.5–27.4.8, 27.5
- Plansee AG  
A-6600 Reutte  
Austria

**Dieter Leininger †**

- § 5.22.6
- Bergbauforschung GmbH  
Franz-Fischer-Weg 61

45307 Essen  
Germany

**Lutz Leitner**

- §§ 5.21.3.1–5.21.3.3
- Bayer AG  
-GB A1-  
51368 Leverkusen  
Germany

**Winfried Lenk**

- Chapter 53
- Chemetall GmbH  
Reuterweg 14  
60323 Frankfurt  
Germany

**Marcel de Liedekerke**

- §§ 10.9.2.1–10.9.2.7
- Graaf de Gelooslaan 8  
NL-6245 AS Eysden  
Netherlands

**Alfred Lipp**

- §§ 49.6
- Bürgermeister-Singer-Str. 15  
86825 Bad Wörishofen  
Germany

**John L. Little**

- §§ 49.4–49.5
- Callery Chemical Co.  
Research & Development  
Boron Labs.  
Callery, PA 16024  
USA

**Manfred Lück**

- §§ 15.1–15.10
- RWTH Aachen  
Institut für Metallhüttenwesen und Elektrometallurgie  
52056 Aachen  
Germany

**Eberhard Lüderitz**

- § 7.8
  - §§ 15.1–15.10
- World Resources Company (WRC) GmbH  
Büro Wurzen  
Lüptitzer Straße 24c  
04808 Wurzen  
Germany

**Heribert Luig**

- § 40.1–40.3
- Universität Göttingen  
Institut für Nuklearmedizin  
Robert-Koch-Straße 40  
37075 Göttingen  
Germany

**J. Paul Lyle**

- § 21.10
- Aluminum Company of America  
Alcoa Laboratories  
Alcoa Center, PA 15069  
USA

**Paul MacMillan**

- §§ 57.1, 57.2, 57.7
- 493 Fortington St.  
Renfrew, Ontario K7V 1E3  
Canada

**Takao Maki**

- § 21.10.7
  - § 51.17
  - § 52.16
- Mitsubishi Chemical Industries Ltd.  
Research Center  
1000 Kamoshida-cho  
Midori-ku, Yokohama  
Kanagawa 227  
Japan

**Manfred Mansmann**

- § 22.7.10
  - § 46.10.1
- Bayer AG  
Geschäftsbereich PK, Geb. R20  
51368 Leverkusen  
Germany

**Brigitte Martin**

- §§ 48.7.1–48.7.2
- Ruhr-Universität Bochum  
Fak. f. Geowiss., Inst. f. Mineralog.  
Postfach 10 21 48  
44780 Bochum  
Germany

**Wilfried Mayer**

- § 5.21.2
- Degussa AG  
Abt. US-IT  
Postfach 1345

63403 Hanau  
Germany

### Gernot Mayer-Schwinning

● § 5.12  
Lurgi Umwelt GmbH  
Forschung und Entwicklung  
Gwinnerstraße 27-33  
60388 Frankfurt  
Germany

### Ian McGill

● Chapter 44  
4 Sheepwalk  
Surley Row  
Caversham  
Reading RG4 8NE  
England

### Albert Melin

● §§ 9.1-9.6  
Cockerillstraße 69-73  
52222 Stolberg  
Germany

### Heinrich Meiler

● § 5.3  
Bornstraße 65  
65719 Hofheim  
Germany

### Adolf Metzger

● § 55.10  
Matterhornstraße 3  
65199 Wiesbaden  
Germany

### Jürgen Meyer

● § 48.7.7  
Degussa AG  
GB Anorg. Chemieprodukte F + E  
Postfach 1345  
63403 Hanau  
Germany

### Hartmut Meyer-Grünow

● § 7.13  
SKW Metals + Alloys Inc.  
3801 Highland Avenue  
Niagara Falls, NY 14305  
USA

### Heinrich Micke

● §§ 37.1-37.10  
Am Domacker 77  
47447 Moers  
Germany

### Edward F. Milner

● §§ 9.1-9.9  
Cominco Ltd.  
Research and Development  
Trail, British Columbia  
Canada VIR 4L8

### Franz-Rudolf Minz

● § 51.14  
Hans-Sachs-Straße 14  
41542 Dormagen  
Germany

### Chanakya Misra

● §§ 21.10.1, 21.10.3.1  
Aluminum Company of America  
Corporate Research & Development  
Alcoa Technical Center  
Alcoa Center, PA 15069  
USA

### Philip C. H. Mitchell

● § 27.6  
The University  
Dept. of Chemistry  
Whiteknights 5  
Reading RG6 2AD  
England

### Lindsay G. Morgan

● § 12.17.5  
Glynteg  
Park Road  
Ynystawe, Swansea SA6 5AP  
Great Britain

### Hans-Georg Nadler

● Chapter 33  
H. C. Starck GmbH & Co. KG  
Werk Goslar  
Postfach 2540  
38615 Goslar  
Germany

### Bernd Neuer

● § 7.3  
● § 48.6

SKW Trostberg AG  
Postfach 1140  
83302 Trostberg  
Germany

### David Nicholls

● § 12.17.2  
University of Liverpool  
Department of Chemistry  
Liverpool L69 3BX  
England

### Ralph H. Nielsen

● Chapter 30  
● Chapter 31  
3424 SW Takena St. SW  
Albany, OR 97321-3603  
USA

### Katsuhisa Nitta

● § 5.21.5  
● § 9.14.5  
● § 15.12.5  
● § 22.7.11  
Merck Japan  
970/04 Onahama  
Japan

### Tony Oates

● § 56.5  
Limetec Quality Services  
19 Macclesfield Road  
Buxton, Derbyshire SK17 9AH  
England

### Manfred Ohlinger

● § 5.21.3.4  
● §§ 46.9.2.2, 46.9.11, 46.10.3  
BASF Aktiengesellschaft  
EPR/P, J 653  
67056 Ludwigshafen  
Germany

### Andreas Otto

● § 7.12  
● Chapter 32  
Gesellschaft für Elektrometallurgie mbH  
Postfach 2844  
90013 Nürnberg  
Germany

### Walter Otto (retired)

● §§ 20.11.2, 20.11.4

Pappelweg 2  
34292 Ahnatal-Weimar  
Germany

### Dag Øymo

● §§ 20.1-20.10  
Norsk Hydro a.s  
P.O. Box 2594, Solli  
N-0203 Oslo 2  
Norway

### Roger Pankert

● §§ 6.4-6.5  
Nöretherstraat 144  
B-4700 Eupen  
Belgium

### Jai Won Park

● §§ 57.3-57.6, 57.8  
Solvay Barium Strontium GmbH  
Postfach 220  
30002 Hannover  
Germany

### Siegfried Paschen (retired)

● § 48.7.3  
Innsbrucker Str. 63  
28215 Bremen  
Germany

### Martin Peehs

● Chapter 41  
Siemens AG  
Power Generation (KWU) — BP  
P. O. Box 3220  
91050 Erlangen  
Germany

### Günter Petzow

● Chapter 19  
Max-Planck-Inst. f. Metallforschung  
Seestraße 92  
70174 Stuttgart  
Germany

### Gerhard Pfaff

● § 5.21.5  
● § 9.14.5  
● § 15.12.5  
● § 22.7.11  
E. Merck KGaA  
Abt. PK FO PE  
Frankfurter Straße 250

64271 Darmstadt  
Germany

### Magnus Piscator

● § 16.11  
The Karolinska Institute  
Dept. of Environmental Hygiene  
P.O. Box 60400  
S-104 01 Stockholm  
Sweden

### Helmold von Plessen

● § 51.16  
Hoechst Aktiengesellschaft  
Verfahrenstechnik  
Postfach 800302  
65926 Frankfurt  
Germany

### David Prengaman

● § 9.12  
RSR Corporation, Res. & Develop.  
Tenth Floor  
1111 West Mockingbird Lane  
Dallas, TX 75247  
USA

### Otto P. Preuss

● § 19.16  
Brush Wellman Inc.  
1200 Hanna Building  
Cleveland, OH 44115  
USA

### Helmut Printzen

● § 5.21.1  
Bayer AG  
Werk Ürdingen, R 86  
Postfach 166  
47812 Krefeld  
Germany

### Horst Prinz

● Chapter 53  
● Chapter 54  
Chemetall GmbH  
Reuterweg 14  
D-60271 Frankfurt am Main  
Germany

### Dieter Råde

● § 22.7.10  
● § 46.10.1

Bayer AG  
GB Pigmente + Keramik  
Rheinuferstraße 7-9  
47812 Krefeld  
Germany

### Ljubisa R. Radovic

● § 5.22.13  
The Pennsylvania State Univ.  
404 Academic Activities Bldg.  
University Park, PA 16802  
USA

### Gerhard Rau

● § 7.3  
● § 48.6  
SKW Trostberg AG  
Forschung und Entwicklung  
Postfach 1140  
83302 Trostberg  
Germany

### Karlheinz Reichert

● Chapter 29  
H.C. Starck GmbH & Co. KG  
Werk Goslar  
Postfach 2540  
38615 Goslar  
Germany

### Arno H. Reidies

● § 47.10  
Carus Chemical Company  
Research Library  
P.O. Box 1500  
La Salle, IL 61301-3500  
USA

### Rainer Reimert

● § 5.22.8  
Universität Karlsruhe  
Engler-Bunte-Institut  
Postfach 6980  
76128 Karlsruhe  
Germany

### Klaus Reinhardt

● Chapter 45  
Th. Goldschmidt AG  
Bosselberg 14  
45134 Essen  
Germany

### Hermann Renner

● Chapter 23 except § 23.4.3  
● Chapter 24  
● Chapter 25  
Zoznegger Str. 5  
78333 Stockach  
Germany

### Hugh Wayne Richardson

● § 8.11 except 8.11.3.4  
Phibro-Tech. Inc.  
P.O. Box 1979  
Sumter, SC 29150  
USA

### H. Hermann Riechers

● § 58.2  
Solvay Barium Strontium GmbH  
Am Güterbahnhof  
53557 Bad Hönningen  
Germany

### Gary G. van Riper

● § 27.10  
Amax Mineral Resources Co.  
1626 Cole Boulevard  
Golden, CO 80401-3293  
USA

### Rafael Rituper

● § 5.20  
Keramchemie GmbH  
Postfach 1163  
56425 Siershahn  
Germany

### William O. Roberts

● § 48.7.4  
Du Pont Chemicals  
Du Pont Experim. Station 262/328  
P.O. Box 80262  
Wilmington, DE 19980-0262  
USA

### Dieter M. M. Rohe

● §§ 10.8.1-10.8.5  
Grillo-Werke AG  
Weseler Str. 1  
47169 Duisburg  
Germany

### Oskar Roidl

● §§ 7.11-7.12

● Chapter 32  
Gesellschaft für Elektrometallurgie  
Postfach 2844  
90013 Nürnberg  
Germany

### Heinz Roller

● § 7.12  
● Chapter 32  
Gesellschaft für Elektrometallurgie  
Postfach 2844  
90013 Nürnberg  
Germany

### Fritz Rose

● § 5.10 except 5.10.1  
Lurgi Metallurgie GmbH  
Lurgiallee 5  
60295 Frankfurt/Main  
Germany

### Gerhard Rose

● §§ 13.1-13.9  
● §§ 14.1-14.10, 14.12-14.13  
Rosa-Luxemburg-Straße 14  
44534 Lünen  
Germany

### Siegfried Sattelberger

● § 7.12  
● Chapter 32  
Gesellschaft für Elektrometallurgie mbH  
Postfach 2844  
90013 Nürnberg

### Dieter Sauter

● §§ 5.22.5, 5.22.8  
Am Jungfernborn 25  
61130 Nidderau  
Germany

### Alan Scaroni

● § 5.22.13  
C211 Coal Utilization Lab.  
The Pennsylvania State Univ.  
University Park, PA 16802  
USA

### Erich Schachl (retired)

● §§ 52.4.1-52.4.2.2  
Kali und Salz AG  
Friedrich-Ebert-Str. 160  
34119 Kassel

Germany

**Klaus Schäfer**

● §§ 6.3.3–6.3.4  
Am Pavillon 6  
49124 Georgsmarienhütte  
Germany

**Dieter Schauwinhold**

● §§ 6.1, 6.7.1  
Scheibenstraße 21  
40479 Düsseldorf  
Germany

**Dietmar Schiffmann**

● § 48.7.9  
Universität Rostock  
Fachbereich Biologie  
Institut für Zoologie, Tierphysiologie und Genetik  
Universitätsplatz 2  
18051 Rostock  
Germany

**Peter Schmidt**

● §§ 46.9.1–46.9.5 except 46.9.2.2; 46.9.10  
Bayer AG  
GB-SP-Chrom, Geb. T18  
51368 Leverkusen  
Germany

**Peter Schmittinger**

● §§ 52.13–52.15  
Germanenstraße 42  
53859 Niederkassel  
Germany

**Klaus Schneider**

● § 5.2.1.2  
Degussa AG  
Abt. AC-GKP  
60287 Frankfurt  
Germany

**Wolf-Dieter Schubert**

● §§ 26.1, 26.2.2, 26.3–26.11  
Grazer Straße 34C  
A-8045 Graz  
Austria

**Karl-Heinz Schulte-Schrepping**

● §§ 16.1–16.10  
Eichenbachstraße 8

53639 Königswinter  
Germany

**Heinz Schultz (retired)**

● §§ 52.3, 52.4 (introduction), 52.4.2.3, 52.4.3–52.4.5,  
52.11 except 52.11.3 and 52.11.7, 52.12, 52.17, 52.18  
Gehrenweg 11  
34292 Ahnatal  
Germany

**Ekkehard Schwab**

● § 5.21.3.4  
● § 46.10.3  
BASF Aktiengesellschaft  
AG-EPR/P, J 653  
67056 Ludwigshafen  
Germany

**Stefanie Schwarz**

● § 16.12  
BASF Aktiengesellschaft  
EPM/TP, J 550  
67056 Ludwigshafen  
Germany

**Karl A. Schwetz**

● §§ 49.6  
Elektroschmelzwerk Kempten GmbH  
Postfach 1526  
87405 Kempten  
Germany

**Jean Scoyer**

● §§ 34.1–34.11  
Union Minière Research  
Kasteelstraat 7  
B-2250 Olen  
Belgium

**Roger F. Sebenik**

● §§ 27.1, 27.4.1–27.4.4  
P.O. Box 3299  
Englewood, CO 80155  
USA

**Karl Seebode**

● § 51.13.4  
Akzo Nobel Salz GmbH  
Postfach 1729  
21657 Stade  
Germany

**Margarete Seeger**

● §§ 20.11 (introduction), 20.11.1, 20.11.3.1–20.11.3.4  
Vesouler-Straße 35  
70839 Gerlingen  
Germany

**Heinz Sibum**

● §§ 22.1–22.6, 22.8–22.12  
Deutsche Titan GmbH  
Altendorfer Straße 103  
45143 Essen  
Germany

**Jack Silver**

● § 5.17.7  
School of Chemical and Life Sciences  
University of Greenwich  
Woolwich Campus, Wellington Street  
London SE18 6PF  
England

**Walter Simmler**

● § 48.5  
Schlinghofenerstraße 10  
51519 Odenthal-Glöbusch  
Germany

**Hartmut Simoleit †**

● § 58.2  
Kali-Chemie AG  
Postfach 220  
30002 Hannover  
Germany

**Matthias Simon**

● §§ 17.1–17.10, 17.13–17.14  
Rheinzink GmbH  
Bahnhofstraße 90  
45711 Datteln  
Germany

**Ole Skåne**

● §§ 20.1–20.10  
Norsk Hydro a.s  
P.O. Box 2594, Solli  
N-0203 Oslo 2  
Norway

**Reiner Skroch**

● § 5.12  
Lurgi GmbH  
Lurgiallee 5  
60295 Frankfurt

Germany

**Robert A. Smith**

● §§ 49.1.1, 49.7–49.13  
U.S. Borax Research Corp.  
412 Crescent Way  
Anaheim, CA 92801  
USA

**Hans Stark**

● §§ 5.17.4–5.17.5  
● §§ 21.10.5.1, 21.10.6  
BASF Aktiengesellschaft  
RCA/N-B516  
67056 Ludwigshafen  
Germany

**Rolf Steffen**

● § 6.3.1  
VDEh  
Sohnstraße 65  
40237 Düsseldorf  
Germany

**Wolfgang Stoll**

● Chapter 42  
Ameliastraße 25  
63452 Hanau  
Germany

**F. Werner Strassburg**

● § 12.16  
Comeniusstraße 5  
47906 Kempen  
Germany

**Charles A. Sutherland**

● §§ 9.1–9.9  
Cominco Ltd.  
Research and Development  
Trail, British Columbia VIR 4L8  
Canada

**Herbert Teindl**

● § 9.10  
Cominco Ltd.  
Research and Development  
Trail, British Columbia VIR 4L8  
Canada

**Stanley A. Thielke**

● § 27.11

Climax Metals Co.  
Amax Center  
Greenwich, CT 06836-1700  
USA

### Christian Thieme

● § 51.15  
Schwanenstraße 124  
42697 Solingen  
Germany

### Manfred Toncourt

● § 6.2  
VDEh  
Informationszentrum Stahl und Bücherei  
Sohnstraße 65  
40237 Düsseldorf  
Germany

### Gerhard Trenczek

● § 46.10.1  
Bayer AG  
Rheinuferstraße 7-9  
47812 Krefeld  
Germany

### Wolfgang Triebel

● §§ 51.1-51.12  
● §§ 55.1-55.8  
Degussa AG  
Werk Wesseling  
Postfach 1164  
50375 Wesseling  
Germany

### Georg Uecker (retired)

● §§ 46.9.7-46.9.9  
Emil-Nolde-Str. 78  
51375 Leverkusen  
Germany

### Ronald J. Veitch

● § 5.21.3.4  
● § 46.10.3  
BASF Akriegesellschaft  
EPR/PM  
67056 Ludwigshafen  
Germany

### Tore Vrålstad

● §§ 20.1-20.10  
Norsk Hydro a.s.  
P.O. Box 2594, Solli

N-0203 Oslo 2  
Norway

### Mark S. Vukasovich (retired)

● § 27.7 except §§ 27.7.4.1-27.7.4.2  
1457 Woodland Drive  
Ann Arbor, MI 48103  
USA

### Heinz Wagner

● §§ 57.3-57.6, 57.8  
● § 58.2  
Solvay Barium Strontium GmbH  
Postfach 220  
30002 Hannover  
Germany

### Peter Wallbrecht

● §§ 57.3-57.6, 57.8  
Solvay Bario e Derivati S.p.A.  
Via Oliveti, 84  
54100 Massa  
Italy

### Ludwig Walter

● § 58.2  
Kali-Chemie AG  
Hauptverwaltung, C-AF  
Postfach 220  
30002 Hannover  
Germany

### Sabine Walter

● Chapter 41  
Universität Hannover  
Institut für Werkstoffkunde  
30167 Hannover  
Germany

### Thomas Walter

● Chapter 41  
PreußenElektra Aktiengesellschaft  
Tresckowstr. 5  
30457 Hannover  
Germany

### John W. Waudby

● § 7.4  
● §§ 47.1-47.9  
Samancor House  
88 Marshall St.  
Johannesburg 2001  
Republic of South Africa

### C. Joseph Weber

● §§ 49.2-49.3  
U.S. Borax Research Corp.  
Chemical Research  
412 Crescent Way  
Anaheim, CA 92801  
USA

### Karl Wefers

● §§ 21.10.1, 21.10.3.1  
Aluminum Company of America  
Corporate Research & Development  
Alcoa Technical Center  
Alcoa Center, PA 15069  
USA

### Wilhelm Wegener †

● § 51.13.3.1  
Hegelmaierstraße 26  
74076 Heilbronn  
Germany

### Maurice W. Wei

● § 21.7  
Aluminum Company of America  
Corporate Research & Development  
Alcoa Technical Center  
Alcoa Center, PA 15069  
USA

### David Bruce Wellbeloved

● § 7.4  
● §§ 47.1-47.9  
Samancor Ltd.  
P.O. Box 8186  
Johannesburg 2000  
Republic of South Africa

### William A. Welsh

● § 48.7.5  
W. R. Grace & Co. — Conn  
7500 Grace Drive  
Columbia, MD 21044-4098  
USA

### Klaus Wessiepe

● § 5.10.1  
Schliepersberg 33A  
45257 Essen  
Germany

### Axel Westerhaus

● §§ 22.7.1-22.7.9

Bayer AG  
Rheinuferstraße 7-9  
Postfach 166  
47812 Krefeld  
Germany

### Gisbert Westphal

● § 51.13 (introduction)  
Damaschkestraße 7  
42655 Solingen  
Germany

### Henning Wienand

● §§ 15.12.1-15.12.4  
BASF Aktiengesellschaft  
-EPM/DA, J 550-  
67056 Ludwigshafen  
Germany

### Ulrich Wietelmann

● Chapter 50  
Chemetall GmbH  
Reuterweg 14  
60271 Frankfurt  
Germany

### Egon Wildermuth

● §§ 5.17.2-5.17.3  
Rückertstraße 1  
51373 Leverkusen  
Germany

### Volker Wilhelm

● § 22.7.10  
● § 46.10.1  
Bayer AG  
PK-P-BZ, Geb. R 32  
51368 Leverkusen  
Germany

### Heinrich Winkeler

● § 5.21.2  
Degussa AG  
Postfach 13 45  
63403 Hanau  
Germany

### Reinhard Winkelgrund

● § 6.7.2  
Stahl-Informations-Zentrum  
Breite Straße 69  
40213 Düsseldorf  
Germany



**Herwig Winkler**

● Chapter 45  
Neckheimgasse 42  
A-9020 Klagenfurt  
Austria

**Peter Winkler**

● §§ 15.1–15.10  
RWTH Aachen  
Institut für Metallhüttenwesen und Elektrometallurgie  
52056 Aachen  
Germany

**Franz Wirsching**

● § 56.6  
Gebrüder Knauf Westdeutsche Gipswerke  
Postfach 10  
97343 Iphofen  
Germany

**Peter Woditsch**

● §§ 22.7.1–22.7.9  
Bayer AG  
AI-Geschäftsfeldleitung IP, Geb. 54  
47829 Krefeld  
Germany

**Hans Uwe Wolf**

● § 10.8.6  
● § 13.10  
● § 14.14  
● § 15.11  
● § 22.14  
● § 26.12  
● § 34.13  
● § 37.11  
● § 58.3  
Universität Ulm  
Pharmakologie und Toxikologie  
Oberer Eselsberg N26  
89069 Ulm  
Germany

**Manfred R. Wolf**

● § 55.11  
BASF Aktiengesellschaft  
Abt. RCA/S, D 404  
67056 Ludwigshafen  
Germany

**Rüdiger Wolf**

● Chapter 29  
H.C. Starck GmbH & Co. KG  
Werk Goslar  
Postfach 2540  
38615 Goslar  
Germany

**Gabriele Wühl-Couturier**

● § 17.12  
Thor-Chemie GmbH  
Landwehrstrasse 1  
67346 Speyer  
Germany

**Jun-Ichiro Yagi**

● §§ 5.5.6–5.5.11  
Inst. for Advanced Materials Processing  
Tohoku University  
1-1, Katahira, 2-chome Aobaku  
Sendai 980-77  
Japan

**Werner Zulehner**

● §§ 48.1–48.4  
Wacker-Siltron AG  
Abteilung FE  
Postfach 1140  
84479 Burghausen  
Germany

**Authorless Sections**

● § 14.11 (Antimony, § 10)  
● § 26.2.1 (Tungsten, § 2.1) (provient de Ullmann 4, Hugo M. Ortner)

**Name Index****A**

Achard, F. C. 1270  
Africanus, Constantinus 824  
Agricola, Georgius 492, 642, 824, 845, 891  
Anderson, C. D. 1586  
Arfvedson, August 2029  
Aristotle 795, 2199  
Ashcroft 2066

**B**

Barrer, R. M. 1967  
Bayer, Karl Josef 1044, 1072  
Bazlen 2240  
Becker, E. W. 1630  
Beckett, F. M. 439  
Becquerel, Henri 1585, 1600  
Bedson, George 278, 282  
Bémont, G. 1593  
Berg 1491  
Bergman, Torbern Olof 716, 924, 1330  
Berthelot, M. 154, 1269, 2239  
Berthier, P. 1044, 1068  
Berzelius 1040, 1431, 1557, 1649, 1697, 1743, 2029  
Bessemer, Henry 278, 280  
Black, Joseph 2253  
Böhm 1062  
Bohr, Niels 1586  
Bonnier 1685  
Boyd 1711  
Brandé 2029  
Brandt, G. 924  
Brown, H. C. 1999  
Bunsen 1040, 2029, 2211  
Burg, A. 1999  
Bussy 955, 981  
Buttman 1813

**C**

Casciorolus, V. 2340  
Castner 2054, 2059  
Cato 2253  
Chadwick, James 1587  
Champion 642  
Chaptal 1106  
Chirkov, N. A. 468  
Claus, C. 1270  
Cleve 1697  
Cockroft, J. D. 1587

Compton, A. H. 1586  
Coolidge, W. D. 1330  
Cort, Henry 277, 279  
Coryell, C. D. 1588  
Courtois 673  
Cowan 1685  
Cramer 673  
Crawford, A. 2329  
Creusot 278  
Cronstedt, Axel F. 716, 1330  
Crookes 1543  
Curie, Irène 1587  
Curie, Marie 1585, 1593, 1600  
Curie, Pierre 1585, 1593, 1600

**D**

D'Ans, J. 2160  
Daelen, Rainer 278, 282  
Dalton 1040  
Darby, Abraham 31, 277, 278  
Davy, Humphry 981, 1040, 1986, 2029, 2054, 2059, 2155, 2329, 2337  
de Andrada, José 2029  
de Boer 1164, 1431  
de Elhuyar, F. 1330  
de Elhuyar, J. J. 1330  
de Maignac 1697  
de Ramecourt 2253  
de Ulloa, A. 1270  
Debierne, A. 1593  
Delafontaine 1697  
Demarcay 1697  
Des Coudres 1585  
Dewey 1062  
Dickinson, J. 966  
Diesbach 179  
Dioscorides, Pedanios 795, 823, 2253  
Dirac, P. A. M. 1586  
Doebereiner, J. W. 1270  
Dony 643  
Downs 2054  
du Faur, Faber 278  
du Monceau, H. I. 1330  
Dwight 586

**E**

Economon 1685  
Einstein, Albert 1587  
Ekeberg 1417

Elkington, J. B. 493, 531  
 Elster 1585  
 Elyutin 483  
 Ercker, Lazarus 824, 1329

**F**

Fajans, K. 1594  
 Faraday 981  
 Fast 1431  
 Fermi, Enrico 1587  
 Firth, W. P. 1476  
 Fischer 1714  
 Fleur 277  
 Ford, Henry 1471  
 Forest 1190  
 Frank, Adolph 2143  
 Frank, K. D. 467  
 Fremy, E. 438  
 Fricke 1062  
 Fritz, John 282

**G**

Gadolin 1697  
 Gahn, J. G. 1813, 2340  
 Garnier, Pierre 716, 1685  
 Gay-Lussac 1261, 1262, 1986  
 Geiger, H. 1586  
 Geiss 643  
 Geitel 1585  
 Giesel, F. O. 1593  
 Gilchrist, Percy C. 278, 280  
 Glauber, J. R. 2121  
 Glendenin, L. E. 1588  
 Gmelin, Christian 1116  
 Göhring, O. 1594  
 Goldschmidt, H. 406, 465, 966, 1761  
 Goodwin, W. L. 1476  
 Gregor 1129  
 Greville 1062  
 Groth, W. 1629  
 Guimet, J. B. 1116  
 Guntz 2337  
 Gusarov, V. N. 463

**H**

Hahn, Otto 1586, 1601  
 Hall 1040  
 Hall, Charles Martin 1044  
 Hamburger 1431  
 Hanamann 1330  
 Hanbury, John 277  
 Hannibal, Paulus 278  
 Harteck, P. 1629

Hatchett 1403  
 Haüy 1062  
 Haynes, E. 924  
 Heberlein 586  
 Heisenberg 1586  
 Heitler, W. 1586  
 Herodotus 1062, 1183  
 Hérault, Paul L. T. 278, 281, 1040, 1044  
 Herschel 1600  
 Hisinger 1697  
 Hoffmann 1685  
 Hofman, W. 1935  
 Hope, T. C. 2329  
 Humboldt, Alexander von 1270  
 Hunter 1130  
 Huntington 586  
 Huntsman, Benjamin 277, 279

**I**

Ilgner 282

**J**

James 1697  
 Jean, G. 439  
 Joliot, F. 1587  
 Just 1330

**K**

Kennedy 1685  
 Khodorovsky, Y. 465  
 Kisselbach, Clemens 282  
 Klaproth, Martin Heinrich 1130, 1431, 1600, 1697  
 Kreutzer, H. W. 285  
 Kroll 1162  
 Kroll, W. J. 1130, 1431  
 Kühne 1862  
 Kunkel 642

**L**

Lamy 1543  
 Langer, Carl 746  
 Lavoisier 1040, 2199, 2253, 2282  
 Lawrence, E. 1586  
 Le Châtelier 1072, 2301  
 Lebeau 955  
 Leblanc 2104  
 Leclaire 673  
 Lecoq de Boisbaudran 1523, 1697  
 Lely 1431  
 Lemery, N. 824  
 Leonardo da Vinci 924  
 Lewis, W. 1270  
 Libavius, Andreas 642, 824

Lipscomb, W. 1999  
 Lloyd 586  
 Löhneys 642  
 London, F. 1586

**M**

Magnus, Albertus 796, 845  
 Mallet 2337  
 Manhès 493, 519  
 Mannesmann, Max 278, 282  
 Mannesmann, Reinhard 278, 282  
 Manuel del Rio 1471  
 Marden 1471  
 Marggraf 642, 1062  
 Marinsky, J. A. 1588, 1700  
 Marsden, E. 1586  
 Martin, Pierre-Émile 278, 281  
 Matthiessen 2029  
 Matuschka, A. 466  
 McArthur 1190  
 McMillan 1685  
 Meitner, L. 1586  
 Mendeleev 1505, 1523  
 Merensky, Hans 1276  
 Miller 1185  
 Milori 179  
 Moissan, Henri 439, 465, 1330, 1600, 1986, 1989  
 Mond, Ludwig 154, 746  
 Morgan, Charles 278, 282  
 Mosander 1697  
 Müller von Reichenstein 1571  
 Mushet 1814

**N**

Nasmyth, James 278  
 Neilson, Jean Beaumont 278  
 Niclassen 1062  
 Nilson 1697  
 Noddack 1491

**O**

Olympiodorus 795  
 Ørsted, Hans Christian 1040, 1111  
 Østerheld 955  
 Ostwald 1309  
 Oxland, R. 1330

**P**

Paracelsus 796, 824, 845, 1105  
 Pattinson 1226  
 Pauli, W. 1586  
 Paynet, John 277  
 Péligot, E. M. 1600

Peppard 1685  
 Perey, M. 1592  
 Perrier, G. 1587, 1589  
 Pidgeon, L. M. 981  
 Plattner 1185  
 Pliny the Elder 823, 1062, 1813, 2086, 2253  
 Polhems, Christoph 277  
 Pott 845  
 Pourcel 1814  
 Powell 1711

**Q**

Quincke, L. 154

**R**

Ramazzini 623  
 Ramsey 1585  
 Rchiladze, V. G. 805  
 Regener, E. 1585  
 Reich, F. 1531  
 Rich 1471  
 Richter, Jeremias 716  
 Richter, T. H. 1531  
 Riss, M. 465  
 Roscoe 1471  
 Rose 1403  
 Ruberg 642  
 Rutherford 1586

**S**

Sack, H. 282  
 Sainte-Claire Deville, H. 1040, 1862, 2054  
 Scaliger, J. C. 1270  
 Scheele, C. W. 796, 1330, 1361, 1813, 2340  
 Scheid 1862  
 Schinkel 643  
 Schlesinger, H. I. 1999  
 von Schlippenbach 586  
 Schönbein 2239  
 Schröder 796  
 Schützenberger 2240  
 Seaborg 1685  
 Seaman, I. J. 282  
 Searles Lake 2154  
 Segré, E. 1587, 1589  
 Shemtchushny 480  
 Siemens, Friedrich 278, 281  
 Siemens, Wilhelm 278, 281, 2054  
 Soddy 1585  
 Solvay, Ernest 2104  
 Spackman 192  
 Spedding 1711, 1712  
 Stahl 642, 2239

Steenbeck, F. 1586  
 Stock, A. 966  
 Stopes 192  
 Strassmann, F. 1587, 1601  
 Strohmeyer 869

**T**

Tacke 1491  
 Tennant, S. 1270  
 Theophrast 795  
 Thomas, Sidney G. 278, 280  
 Torney 1062

**U**

Urbain 1697  
 Urey, H. C. 1587

**V**

Valentinus, Basilius 824, 845  
 van Arkel 1130, 1164, 1431  
 van Nordstrand 1062, 1064  
 van't Hoff 2160  
 Vauquelin 955, 1062, 1106, 1761  
 Villard, P. 1585  
 Vivian, A. C. 966  
 von Hevesy 1437  
 von Leonhard, K. C. 1330  
 von Liebig, Justus 2143  
 von Nägeli 1264

von Setz, R. 1476  
 von Welsbach, Auer 1678, 1697, 1743, 1751

**W**

Wahl 1685  
 Walton, E. T. S. 1587  
 Wartman 1130  
 Watson, W. 1270  
 Weidenhammer, P. 924  
 Weintraub 1986  
 Westwood, John 277  
 Wetherill, S. 673  
 Widerøe, R. 1586  
 Wilkinson, J. 281, 1310  
 Winkler 214, 1505, 1862  
 Withering, W. 2340  
 Wöhler, Friedrich 1040, 1862  
 Wohlwill, E. 493, 531, 1185  
 Wollaston, W. H. 1270  
 Wood, C. 1270

**X**

Xenophon 2253

**Y**

Yukawa 1587

**Z**

Zadra 1193

**Subject Index****A**

Abrasion-resistant alloy 471  
 Abrasive hydroxide 1096  
 Abrasives 1012, 1921  
 Absorption agents 1931  
 Accumulators 874  
 Acetaldehyde from ethanol 1258  
 Acetylene 215  
 Achrematite 1363  
 Acicular goethite 153  
 Acid digestion 1657  
 Acid pressure leaching 741  
 Acrylate-acrylamide copolymers 1079  
 Actinides 1650  
 Actinium 11, 1593  
 Actinon 10  
 Activated aluminas 1096  
 Activated carbon 210, 215, 905, 1191, 1199, 1259, 2158  
 Activating agent 665  
 Active manganese dioxide 1839  
 Acute effects of lead 625  
 Additive to fodder 149  
 Additives for gasoline 633  
 Adducts 2287  
 Adsorbents 1096, 1953  
 Adsorption  
   of gold by carbon 1191  
   of hydrogen fluoride 1094  
   of water on activated alumina 1098  
 Aerated concrete 2270  
 Affination 1185, 1194, 1197  
 Age-hardenable copper alloys 955  
 Agglomeration 41, 43, 215, 737, 1081  
 Agitation leaching 526  
 Air for blast furnace 54  
 Air pollution control 132, 133  
 Aircraft turbine blades 1499  
 Akmite 1914  
 Albite 1092  
 Alcan cell 991  
 Alcohol dehydration 1099  
 Alcoholates 1110  
 Aldoxime 1296  
 Algicidal action 672  
 Alginite 194  
 Aliphatic carboxylic acids 873  
 Aliphatic polysulfides 2230  
 Aliphatic sulfides 205  
 Aliquat 1370  
 Alkali aluminate 1121  
 Alkali amalgam 909  
 Alkali dichromates 1798  
 Alkali metal billets 2070  
 Alkali metal cyanides 1187  
 Alkali metal peroxides 1187  
 Alkali metal polysulfide 1187  
 Alkali metal silicofluorides 1891  
 Alkali metals 3, 12  
 Alkali polysulfides 2222  
 Alkali sulfur compounds 2221  
 Alkali-metal niobates 1408  
 Alkaline cyanide solutions 1198  
 Alkaline digestion 1660  
 Alkaline-earth metals 3, 13  
 Alkaline-earth soaps 678  
 Alkaline-earth titanates 1172  
 Alkanes 2059  
 Alkoxides 2058, 2067  
 Alkoxyalkyl mercury 919  
 Alkoxysilanes 1897, 1934  
 Alkyl tin halides 712  
 Alkyl tin hydrides 1894  
 Alkyl xanthates 1366  
 Alkylation 2157  
 Alkylmercury compounds 919  
*p*-Alkylphenols 2212  
 Allanite 1655, 1697  
 Allenite 1030  
 Allotropic forms of boron 1987  
 Allotropic forms of cobalt 925  
 Alloy steels 9, 385  
 Alloyed cast iron 342  
 Alloying elements 283, 404  
 Alloys with ceramic veneers 1315  
 Alluvial gold 1185  
 Alluvial placers 687  
 ALNICO 40  
 Alum 962  
 Alum-containing ores 1104  
*Alumen* 1062, 1105  
 Alumina 1062, 1110  
   chemicals 1095  
   desiccant 1098  
   gels 1097  
   in catalytic processes 1099  
   production 1091  
   -supported catalysts 1100  
 Alumina-zirconia abrasives 1446  
 $\beta$ -Aluminas 1068

Aluminates 1068, 1109  
 Aluminosilicate lattice 1116  
 Aluminosilico reactions 409, 414  
 Aluminothermic Mn 406  
 Aluminothermic processes 406, 468, 1768  
 Aluminothermic production of ferroboreon 467  
 Aluminothermic reduction of niobium oxide ores 472  
 Aluminum 7, 18, 1039  
   alloys 1000  
   casting 1055  
   cell emissions 1056  
   chlorination 1112  
   coating 355  
   electrodes 1115  
   in drinking water 1000  
   industry 2120  
   master alloys 469  
   oxidation 1042  
   pigments 1116  
   powder 414  
 Aluminum alkoxides 1110  
 Aluminum Association 19  
 Aluminum borohydride 1113  
 Aluminum carbide 1053  
 Aluminum chloride 1111  
 Aluminum chloride hydroxides 1114  
 Aluminum fluoride 1046, 1054, 1096  
 Aluminum hydrogen phosphate 1121  
 Aluminum hydroxides 1062, 1095  
 Aluminum hydroxychlorides 1114  
 Aluminum *iso*-propoxide 1111  
 Aluminum-lithium alloy 2043  
 Aluminum-magnesium alloys 1000  
 Aluminum-niobium 472  
 Aluminum oxide 1042, 1045, 1062  
 Aluminum oxide chlorination 1112  
 Aluminum oxide hydroxide 1063, 1065, 1097  
 Aluminum oxychloride 1111  
 Aluminum phosphate 1122  
 Aluminum phosphates 1085  
 Aluminum-refining cell 1054  
 Aluminum *sec*-butoxide 1111  
 Aluminum-silicon alloy 1054  
 Aluminum suboxide vapor 1053  
 Aluminum sulfate 1102, 1116  
 Aluminum sulfate neutralization 1097  
 Aluminum zinc phosphate 1121  
 Alums 150, 938, 1105  
 Alumite 1093, 2196  
 Amalgam electrolysis 653  
 Amalgamation 6, 1189, 1217, 1224, 1232  
 Amalgams 709, 908, 1188, 1281, 2101  
 Aman process 1018  
 Amax process 769  
 Amblygonite 2033, 2036  
 Amex process 1662  
 Amidosulfuric acid 613  
 Amine boranes 2002  
 Amine process 2200  
 Amine tungstates 1351  
 Amines 1615, 1718  
 Aminocarboxylic acids 1711  
*o*-Aminomethylphenols 873  
 Ammonia  
   absorption 2111  
   oxidation 1309  
   recovery 2113  
   synthesis 1100  
 Ammonia-soda process 2106, 2110, 2121  
 Ammoniacal leaching 738, 931  
 Ammonium alum 1108  
 Ammonium alum neutralization 1097  
 Ammonium aluminum sulfate 1108  
 Ammonium amalgam 909  
 Ammonium borates 2017  
 Ammonium carnallite 1010  
 Ammonium chloride 1120  
 Ammonium chromate 1790  
 Ammonium chromium(III) sulfate 1785  
 Ammonium dichromate 1790, 1799  
 Ammonium dimolybdate 1369  
 Ammonium diuranate 1620, 1622  
 Ammonium ferric sulfate for tanning 150  
 Ammonium fluoroborate 1996  
 Ammonium-hafnium carbonate 1460  
 Ammonium heptamolybdate 1376, 1382  
 Ammonium hexachloroiridate(IV) 1298, 1300  
 Ammonium hexachloropalladate(IV) 1297, 1303  
 Ammonium hexachloroplatinate 1270  
 Ammonium hexachlororhodate(III) 1294, 1298, 1300  
 Ammonium hexachlororuthenate(III-IV) 1300  
 Ammonium hydrogen sulfide 766  
 Ammonium magnesium arsenate(V) 812  
 Ammonium metavanadate 1483, 1487  
 Ammonium paratungstate 1338, 1340  
 Ammonium pentaborate 2017, 2020  
 Ammonium perhenate 1494, 1496, 1499  
 Ammonium persulfate 164  
 Ammonium polyvanadate 1483  
 Ammonium sulfamate 739  
 Ammonium sulfate 739, 742  
 Ammonium tetraborate 2020  
 Ammonium tetrafluoroberyllate 964  
 Ammonium tetrathiomolybdate 1379, 1381  
 Ammonium thiocyanate 1494  
 Ammonium thiosulfate 2234, 2238  
 Ammonium uranyl carbonate 1620, 1621, 1622  
 Ammonium vanadate 864  
 Ammonium zirconium carbonate 1450

Ammonium zirconium sulfates 1450  
 Amorphous alloys 467  
 Amorphous boron 1987, 1991  
 Amorphous silicon 1882  
 Amphoteric metal 1122  
 Analysis of metallic tin 707  
 Analysis of platinum group metals 1305  
 Anatase 1069, 1134-1137, 1143  
 Andorite 1221  
 Andrussov process 1309  
 Anglesite 584  
 Anhydrite 2145, 2174, 2281  
 Anhydrite plaster 2301  
 Anhydrous aluminum chloride 1116  
 Anhydrous copper sulfate 562  
 Anhydrous iron(III) chloride structure 150  
 Anhydrous magnesium chloride 1004, 1009  
 Anhydrous magnesium nitrate 1003  
 Anhydrous magnesium sulfate 1032  
 Anion-exchange membranes 2129  
 Anion-exchange resins 1199  
 Anionic complexes 1718  
 Anisometric forms of Fe<sub>3</sub>O<sub>4</sub> 186  
 Anisotropic structures in coke 237  
 Annealing 347  
 Anode baking furnaces 1057  
 Anode effect 1050, 1165  
 Anode slimes 533, 615, 704, 832, 1047, 1218, 1228, 1284, 1560, 1573  
   of electrolytic lead refinery 852  
 Anodic dissolution of silver scrap 1236  
 Anodic oxidation of potassium manganate(VI) 1850  
 Anodized aluminum 944  
 Anorthite 1092  
 Anorthosite 1092  
 Antarcticite 2311  
 Anthoinite 1333  
 Anthracite 199, 203, 205, 1045  
 Anthraquinone production 1113  
 Anticaking agents 2092, 2189  
 Anticor 679  
 Anticorrosive pigments 189, 676, 678  
 Anticorrosive zinc oxide 677  
 Antidandruff agent 666  
 Antidotum Thalii 184  
 Antiknock agent 634  
 Antimonates 839  
 Antimonial copper ores 833  
 Antimonial lead 833, 840  
 Antimonic acid 839  
 Antimonite 825, 894  
 Antimony 6, 823, 846  
   black amorphous 823  
   explosive 823  
   native 825  
   red 825  
   scrap 833  
   spots 842  
   yellow 823  
 Antimony bloom 838  
 Antimony(III) chloride oxide 837  
 Antimony hydride 843  
 Antimony-lead alloys 832  
 Antimony oxide 838, 840  
 Antimony(III) oxide 826, 838, 842, 843  
 Antimony(IV) oxide 826, 839  
 Antimony pentachloride 838, 843  
 Antimony pentafluoride 838, 843  
 Antimony pentasulfide 839, 843  
 Antimony pentoxide 839, 843  
 Antimony sulfate 840  
 Antimony sulfides 839, 841  
 Antimony tribromide 838  
 Antimony trichloride 836, 837, 843  
 Antimony trifluoride 838, 843  
 Antimony triiodide 838  
 Antimony trisulfide 839, 842, 843  
 Antiperspirants 1116  
 Antlerite 498  
 Apatite 34, 39, 1085, 1698  
 Aqua regia 1043, 1197, 1285, 1306  
 Aquamarine 961  
 Aqueous chemistry of molybdenum 1377  
 Aqueous electrolysis 1313  
 Aqueous oxidation of iron sulfides 164  
 Aqueous oxidation prior to cyanidation 34  
 Aqueous thiosulfate 1232  
 Aragonite 2253  
 Arbitrator process 529  
 Arenite 1915  
 Argentiferous copper ores 1222  
 Argentiferous lead ores 1222  
 Argentiferous tetrahedrite 830  
 Argentite 1221  
 Argentometry 1262  
 Argentopyrite 1221  
 Argyrodite 1221, 1505, 1507  
 Argyropyrite 1221  
 Armaments 1346  
 Armco process 112  
 Arsenates 799  
 Arsenates(III) 796, 810  
 Arsenates(V) 812  
 Arsenic 6, 653, 795, 820  
   black 795  
   brown 795  
   crystalline 805  
   high-purity 806

native 797  
white 795  
Arsenic acid 165, 811, 812  
Arsenic acid hemihydrate 820  
Arsenic(III) bromide 814  
Arsenic(III) chloride 814–820  
Arsenic(V) chloride 814  
Arsenic(III) fluoride 814, 820  
Arsenic(V) fluoride 814  
Arsenic halides 814  
Arsenic hydride 796, 814  
Arsenic(III) iodide 814  
Arsenic oxides 797, 925  
Arsenic(V) oxychloride 814  
Arsenic pentoxide 796, 811, 820  
Arsenic poisoning therapy 818  
Arsenic precipitation 808  
Arsenic(III) sulfide 817  
Arsenic sulfides 797, 813  
Arsenic trioxide 796, 797, 809, 817, 820  
refined 803  
Arsenical materials roasting 799  
Arsenic war gases 818  
Arsenic-containing by-products 807  
Arsenic-containing copper concentrate 801  
Arsenic-containing gold ores 1185  
Arsenic-containing pyrite concentrates 801  
Arsenides 796, 815  
Arsenites 796  
Arsenolite 809  
Arsenopyrite 33, 164, 165, 797–801, 805, 928  
Arsenous acid 796, 810  
Arsine 814, 815, 819, 820  
Artists' colors 1120  
Arylmercury compounds 919  
ASARCO shaft furnace 535  
Asbestos 32, 1003, 1032  
Asbolite 928  
Ascharite 1987, 2145  
Ascorbic acid production 2127  
Asphaltites 1472  
Assay methods 1306  
Astatine 1588  
Astrakhanite 1030, 2122, 2145, 2161  
Astringent 666  
Atacamite 498, 528  
Atmospheric corrosion 365  
Atomic hydrogen arc welding 1255  
Atomic volume of iron 373  
Atomizing molten aluminum 1122  
Attrition mill 967  
Audio cassettes 186  
Augustin process 1232  
Auranofin 1202  
Aureolin yellow 944  
Austenite 143, 144  
Autoclaves 656, 671, 739, 757, 767–768, 931, 964  
Autoclaves for cultured quartz 1914  
Autogenous smelting 513  
Automobile catalytic converters 1279, 1284, 1310, 1320  
Autooxidation 164  
of disulfide ion 164  
Autunite 1606  
Avicennite 1544  
Awaruaite 32  
Azurite 498

**B**  
*Bacillus subtilis* 843  
Bacterial leaching 526  
Bactericidal effect of silver 1264  
Bactericide 6  
Bacteriostatic compound 1253  
Bad Dürkheim 2211  
Baddeleyite 405, 1434, 1435, 1460  
fusion 1437  
Bahnmittel 2030, 2043  
Bainite 645  
Bai-Yin copper smelting process 512  
Balbach–Thum electrolysis 1242  
Balling 216  
Barite 670, 2342  
Barium 13, 2337  
Barium aluminates 1110  
Barium borates 2020  
Barium carbonate 188, 2346  
Barium chlorate 2348  
Barium chloride 1054, 2348  
Barium chromate 1790  
Barium ferrite 2349  
Barium ferrite pigments 188–189  
Barium fluoride 1054  
Barium hexaferrite 188  
Barium hydroxide 2350  
Barium magnesium tantalate 1424  
Barium nitrate 2351  
Barium oxide 409, 2349  
Barium peroxide 411  
Barium polysulfides 2346  
Barium sulfate 673, 2342  
in lithopone 669  
Barium sulfide 2345  
Barium titanate 2352  
Barium zinc tantalate 1424  
Barringtonite 1003  
*Baryta* 2340  
Basalt 32, 1070  
BASF-Grünkopper 572

Basic aluminum chloride 1114, 1116  
Basic aluminum sulfate 1107  
Basic beryllium acetate 973  
Basic beryllium carbonate 964, 973  
Basic copper(II) acetate 564  
Basic copper(II) sulfates 562, 572  
Basic iron(III) acetate 160  
Basic lead acetate 629  
Basic lead carbonate 629, 636  
Basic nickel carbonate 764, 766, 776  
Basic oxygen furnaces 1022  
Basic potassium aluminum sulfate 1107  
Basic zinc phosphate 678  
Basic zinc potassium chromate 1806  
Bastnæsinite 1685, 1697, 1707, 1708, 1723, 1744  
Batac jig 206  
Batteries 4–6  
Battery types 616  
Battery-grade manganese ores 1817  
Bauxite 10, 25, 1068, 1090, 1104, 1106, 1473, 1524, 2212  
Bauxite residue, see *Red mud* <Default ¶ Font>  
Bayer process 1069, 1072, 1109, 1524  
Bayerite 1062, 1063, 1098  
Baykisol 1947  
Bearing alloys 6  
Bearings 5  
Béchamp reaction 176  
Bedded chert 1912  
Beehive ovens 251  
Behavior of impurities in blast furnace 55  
Belonesite 1363  
Bementite 1815  
Beneficiated feed to blast furnace 61  
Beneficiation  
of iron ore 39  
of nickel sulfide ores 722  
of ores 2120  
Benz[*a*]anthracene 1057  
Benzo[*a*]pyrene 1057  
Benzofluoranthene 1057  
Berlin blue 179, 1104  
Berlin white 179  
Bernic Lake, Canada 2211  
Bertrams process 2099, 2100  
Bertrandite 961, 963  
Beryl 960  
Beryl Picker 961  
Beryllides 971, 973  
Berylliosis 976  
Beryllium 6, 13, 955, 1000  
disease 976, 977  
pebbles 966  
powder 967  
single crystals 968  
Beryllium ammonium phosphate 973  
Beryllium bromide 973  
Beryllium carbide 972  
Beryllium chloride 965, 973  
Beryllium chloride electrolysis 966  
Beryllium chloride reduction 965  
Beryllium–copper 976  
Beryllium fluoride 964, 973  
Beryllium fluoride reduction 965  
Beryllium hydride 972  
Beryllium hydroxide 963, 973  
Beryllium magnesium fluoride slag 965  
Beryllium nitrate 973  
Beryllium nitride 960, 972  
Beryllium orthophosphate 973  
Beryllium oxide 956, 972  
Beryllium oxide chlorination 965  
Beryllium perchlorate 973  
Beryllium-rich alloys 971  
Beryllium sulfate 973  
Berzelianite 1559  
Berzelius' reduction of K<sub>2</sub>TaF<sub>7</sub> by Na 406  
Bessemer converter 493, 519  
Bessemer process 17, 31  
Betafite 1606, 1698  
Betatron 1587  
Betts process 614  
Beverage cans 21  
Bimetallic powders 1313  
Binary compounds of boron 2003  
Bindzil 1947  
Biochemical coalification 195  
Biocidal paints 6  
Biorecovery 1190  
Bipolar membrane process 171  
Birnessite 1830  
Bischofite 983, 1007–1011, 1018, 2145, 2162, 2167  
Bismite 846  
Bismuth 6, 845  
alloys 857  
compounds 859  
dross 613, 851  
from copper and tin concentrates 854  
from lead concentrates 849  
in medicine 859  
pigments 863  
separation from tin concentrates 855  
Bismuth chloride oxide 859, 863  
Bismuth glance 846  
Bismuth molybdate catalysts 1384  
Bismuth nitrate 864  
Bismuth nitrate oxide 863  
Bismuth ochre 847

- Bismuth oxides 860  
 Bismuth oxychloride 863, 865  
 Bismuth pentafluoride 859, 860  
 Bismuth pentoxide 861  
 Bismuth phosphate 861  
 Bismuth telluride 1578  
 Bismuth titanate 863  
 Bismuth tribromide 859, 860  
 Bismuth trichloride 859, 860  
 Bismuth trifluoride 859, 860  
 Bismuth triiodide 859, 860  
 Bismuth trinitrate 860  
 Bismuth trinitrate pentahydrate 859  
 Bismuth trioxide 859, 860  
 Bismuth trisulfide 859, 861  
 Bismuth vanadate 863, 864  
 Bismuth vanadate molybdate 864  
 Bismuth vanadate pigments 865  
 Bismuth-containing drosses 851  
 Bismuth-containing molybdenum ores 848  
 Bismuthine 860  
 Bismuthinite 1364  
 Bismuthyl carbonate 859, 860  
 Bismutite 847  
 Bismutospherite 847  
*Bismutum* 845  
 Bittersalz 1030  
 Bitumen 216  
 Bituminite 194  
 Bituminous coal 199, 203, 205  
 Bixbyite 1815  
 Black amorphous antimony 823  
 Black-and-white photography 1258  
 Black arsenic 795  
 Black copper 529  
 Black Fe<sub>3</sub>O<sub>4</sub> pigments 174  
 Blanc fixe 671, 2344  
 Blancolen 2242  
 Blankit 2242  
 Blast furnace 133, 276  
   as a countercurrent heat exchanger 58  
   flue dust 53  
   gas 55  
   plant 97  
   slag 55, 137  
   sludge 137  
 Blast humidity control 62  
 Blister copper 529  
 Blister steel 279  
 Bloedite 1030  
 Bloomery furnace 31, 275  
 Blooms 31  
 Blue Shield 572  
 Blue ultramarine 1116  
 Blumenfeld method 1142  
 Boehmite 1062–1065, 1068, 1072–1075, 1097  
 Bog iron ore 33  
 Boiler ash 1479  
 Boliden electric furnace 597  
 Boliden Kaldo 597, 599  
 Bolzano process 993, 994  
 Bonding of elements in coal 204  
 Boracite 466, 468, 1987, 2145  
 Boranes 1998  
 Borates 1986  
   glasses 2018  
   in seawater 1017  
   ores 468  
   pigments 2021  
 Borax 1987, 2059  
 Bordeaux mixture 571  
 Boric acid 468, 748, 2007, 2019, 2021, 2126  
 Boric oxide 466, 468, 2006  
 Boride-forming metals 467  
 Borides 467, 1988, 2002  
 Bornite 33, 498  
 Borohydrides 2001  
 Boron 12, 1011  
   allotropic forms 1987  
   binary compounds 2003  
   minerals 466  
   pigments 2021  
 Boron carbide 12  
 Boron halides 1991, 1995  
 Boron nitride 12  
 Boron subhalides 1997  
 Boron sulfide 1998  
 Boron tribromide 1994, 1995  
 Boron trichloride 1886, 1993, 1995  
 Boron trifluoride 1993, 1994  
 Boron triiodide 1994, 1995  
 Boron trioxide reduction 1989  
 Borosilicate pigments 2021  
 Boroxol 2006  
 Boulangerite 584  
 Bourmonite 498  
 Brannerite 1606  
 Brass 4, 641  
 Braunite 1815  
*Braunstein* 1838  
 Brazing 1168, 1343, 1374  
 Breeder reactor 11  
 Breithauptite 719  
 Breunnerite 1014  
 Briarite 1507  
 Bright coal 199  
 Brilliant primrose yellow 863  
 Brine purification 2109

- Briquetting 210  
 Brixlegg process 513  
 Brochantite 498  
 Bromargyrite 1221  
 Bromide in seawater 1017  
 Bromine 987  
 Bromosilicon hydrides 1894  
 Bromyrite 1221  
 Bronze 4  
 Bronze blue 179  
 Brookite 1134, 1136  
 Brown arsenic 795  
 Brown coal 200, 201, 220  
 Brown pigments 174  
 Brucite 983  
 Bukovite 1544  
 Bullion 591  
 Bunsen process 2057  
 Burkeite 1085, 2122, 2154  
 Busbars 18  
 Bustamente furnace 896  
 Bustle pipe 58  
 Butyl rubber production 1113  
 Butyllithium 2042, 2049  
 By-product cobalt 770  
 By-products of copper smelting 673  
**C**  
 Cable sheathing 4, 619  
*Cadmia* 642, 673, 869  
 Cadmium 5, 24, 594, 806, 846, 869, 877  
   alloys 875  
   cementation 871  
   coatings 874  
   distillation 873  
   electrolytic deposition 872  
   emission 878  
   in blood 883  
   in cigarettes 883  
   in soil 879  
   in tobacco 880  
   pigments 873, 884  
   poisoning 881  
   recycling 873  
 Cadmium antimonide 837  
 Cadmium carbonate 870, 876  
 Cadmium chloride 876  
 Cadmium cinnabar 886  
 Cadmium consumption 880  
 Cadmium-containing alloys 871  
 Cadmium-containing waste 873  
 Cadmium cyanide 876  
 Cadmium hydroxide 876  
 Cadmium mercury sulfide 886  
 Cadmium mercury telluride 1579  
 Cadmium nitrate 877  
 Cadmium oxide catalyst 876  
 Cadmium oxides 876, 880  
 Cadmium red 885, 887  
 Cadmium selenide 875, 1565, 1567  
 Cadmium–selenium–indium alloy 875  
 Cadmium sulfate 877  
 Cadmium sulfate in electroplating 877  
 Cadmium sulfide 870, 880, 884, 885, 888  
 Cadmium sulfite 876  
 Cadmium sulfoselenide 880, 885, 1565  
 Cadmium telluride 1578  
 Cadmium–tin alloys 873  
 Cadmium yellow 885, 887  
*Calaeum* 642  
 Calamine 645  
 Calcination of  $\alpha$ -FeOOH 174  
 Calcination of Al(OH)<sub>3</sub> 1086  
 Calcined alumina 1101  
 Calcined dolomite 1003  
 Calciothermic production of titanium alloys 1167  
 Calcite 34, 1014, 2253  
 Calcium 2249  
   content of Al<sub>2</sub>O<sub>3</sub> 1085  
   ferroalloys 2252  
 Calcium aluminate 1092  
 Calcium arsenate 608, 612, 809, 812, 820  
 Calcium borates 2016, 2020  
 Calcium carbide 215, 2059, 2270  
 Calcium carbonate 2087  
 Calcium chloride 699, 1144, 2311  
 Calcium chromate 1790  
 Calcium chromite 409  
 Calcium cyanamide 2317  
 Calcium cyanate 2322  
 Calcium cyanide 1190  
 Calcium cyanurate 2322  
 Calcium dichromate 1790  
 Calcium ferrite 44, 50, 678, 1916  
 Calcium fluoride 1047, 1057  
 Calcium hexacyanoferrate(II) 180, 1104  
 Calcium hydroxide 1016  
 Calcium–manganese–silicon 404  
 Calcium molybdate 1333, 1370  
 Calcium oxide 509  
 Calcium plumbate 635  
 Calcium silicate slags 293  
 Calcium silicon 404, 1900  
 Calcium–silicon–aluminum 404  
 Calcium–silicon–barium 404  
 Calcium–silicon–magnesium 404  
 Calcium–silicon–titanium alloys 475  
 Calcium–silicon–zirconium 404  
 Calcium sodium borates 2016

- Calcium stannate 608, 612  
 Calcium sulfate 2087, 2090, 2281  
 Calcium sulfide 2116  
 Calcium thiosulfate 1218  
 Calcium titanate 1172  
 Calomel 911  
 Calorific value 202, 220  
 Canfeldite 1507  
 Canga 37  
 Cannon process 2192  
 Capacitors 9  
 Carat 8  
 Carbides 996  
 Carbiding of zircon 1437  
 Carbido-carbonyls 939  
 Carbochlorination of zircon 1435, 1462  
 Carbon black 215  
 Carbon bricks 101  
 Carbon regeneration 1194  
 Carbonaceous material 198  
 Carbon-in-leach 1194  
 Carbon-in-pulp 1191, 1192  
 Carbonitrides 1173  
 Carbonization 211  
 Carbonization assay 202  
 Carbonization of coal 211  
 Carbonyl complexes of cobalt 940  
 Carbonyl iron 143, 157, 159  
 Carbonyl iron oxide 158  
 Carbonyl process 752, 933, 1283  
 Carbothermal silicon 1865  
 Carbothermic ferroboration 467  
 Carbothermic production of ferrotitanium 475  
 Carbothermic production of ferrotungsten 464  
 Carbothermic reduction 441, 983  
 Carbothermic reduction of  $\text{MoO}_3$  478  
 Carboxylic acids 1718  
 Carburization 370  
 Carcinogenicity 625, 883  
 Carnallite 983, 987, 1004, 1007–1009, 2143, 2145, 2153, 2154, 2159, 2162, 2166, 2174, 2180, 2212, 2311  
   decomposition 2169  
   dehydration 988  
 Carnegite 1902  
 Carnotite 1472, 1606  
 Caron process 758, 764, 767, 776, 1831  
 Carrollite 928, 930  
 Case hardening of steels 370  
 Case-hardened steels 471  
 Cassiterite 686, 689, 1418, 1656  
 Cassiterite-sulfide deposits 687  
 Cast house dedusting 135  
 Cast iron 1, 146, 341  
   ductile 2  
   grey 2  
   malleable 2  
   white 1  
   with vermicular graphite 342  
 Cast steel 338  
 Casting 318, 1374  
 Casting of anodes 531  
 Casting thin slabs 334  
 Castner process 2057, 2060  
 Catalan forge 31, 275  
 Catalyst in organic syntheses 676  
 Catalyst poisoning 1310  
 Catalyst support 1105  
 Catalyst-forming methods 1099  
 Catalysts 4, 6, 9, 10, 21, 152, 665, 1308, 2213  
 Catalytic aluminas 1096, 1099  
 Catalytic dehydrogenation of methanol 1258  
 Catalytic hydrolysis of benzotrichloride 665  
 Cathode lining 1057  
 Cathode-ray tubes 1539  
 Cathodic protection 661  
 Cathodic sputtering 1255, 1314  
 Cation complexation 873  
 Cattierite 928  
 Caustic magnesia 1020, 1021  
   in agriculture 1024  
   in building industry 1024  
 Causticization 1075, 2274  
 Celestite 2330  
 Cell design 1094  
 Cell gas dry scrubbing 1094  
 Cell heat loss 1051  
 Cement 2253, 2257  
 Cement copper 529  
 Cementation 527, 656  
   of cadmium 871  
   with zinc 657  
 Cementation furnaces 278  
 Cemented carbides 936  
 Cemented tungsten carbide 1357  
 Cementite 145, 146  
 Centre d'information cuivre, laitons et alliages 545  
 Centrifuge 208  
 Ceramic capacitors 1409  
 Ceramic coatings 944  
 Ceramic industries 1374  
 Ceramic method 188  
 Ceramic silicon carbide 1373  
 Ceramic uses of alumina 1101  
 Ceramic-bonded bricks 1023  
 Ceramic-grade niobium pentoxide 1409  
 Ceramics 943, 1921  
 Cerargyrite 1221

- Cerium 12, 1743, 1749  
 Cerium earths 1695, 1698  
 Cerium(IV) oxide 1753  
 Cermets 1771  
 Cerro Matoso ferronickel 457  
 Cerulean blue 944  
 Cerussite 584  
 Cervantite 825  
 Cesium 2215  
 Cestibantite 2216  
 Chain reaction 11  
 Chalcantite 498  
 Chalcedonies 1919  
 Chalcedony 1907, 1908  
 Chalcocite 498, 930, 1363, 1367  
 Chalcopyrite 24, 33, 34, 152, 498, 719, 1277, 1363, 1367  
   chlorination 509  
   leaching 152  
   reduction 509  
 Chalcothallite 1544  
 Chalk 2255  
 Challenger expedition 1828  
 Chamotte 696, 1023  
 Champion WP 572  
 Changing technology 17  
 Char 242, 243, 244  
 Characterization of coals 202  
 Char-forming reactions 244  
 Chemical detinning 706  
 Chemical manganese dioxide 1840  
 Chemical structure of coal 200  
 Chemical vapor deposition 159, 1865, 1866, 1868  
 Chemically bonded bricks 1023  
 Chemically resistant steels 270  
 Chemico process 931  
 Cheralite 1655  
 Chert 1912  
 Chevrel phases, see *Ternary molybdenum chalcogenides*  
 Chiles anodes 527  
 Chillagite 1363  
 Chinese blue 179  
 Chloanthite 797, 815  
 Chlor-alkali electrolysis 2096, 2188  
 Chlorhydrol 1116  
 Chloride distillation 1438  
 Chloride leach processes 743  
 Chloride process 1141, 1143, 1150  
 Chloridization 504, 694, 834  
 Chloridizing roasting of copper ores 1218  
 Chlorinated organic compounds 999  
 Chlorinating agents 1161  
 Chlorination 151, 963, 1406, 1744  
   of aluminum 1112  
   of aluminum oxide 1112  
   of beryllium oxide 965  
   of chalcopyrite 509  
   of ferroalloys 1406  
   of magnesia 984  
   of magnesite 984  
   of pyrite cinder 2126  
   of titanium dioxide 1160  
 Chlorine 2062  
 Chlorine dioxide 2126  
 Chloroantimonic acid 836  
 Chlorobenzenes 999  
 Chlorocalcite 2311  
 Chlorodibenzofurans 999  
 Chlorodibenzo-*p*-dioxins 999  
 Chloromethanes 999  
 Chloropentamminerhodium(III) chloride 1294  
 Chlorosilanes 1878  
 Chloro-*tris*-(triphenylphosphine)rhodium(I) 1304, 1310  
 Chromate pigments 1801, 1805  
 Chrome green 1803  
 Chrome orange 1803  
 Chrome yellow 1801  
 Chrome-magnesia 101  
 Chromia-impregnated alumina catalyst 1100  
 Chromic acid 453  
 Chromic acids 1787  
 Chromite 33, 1762  
 Chromite ores 439, 441  
 Chromium 12, 405, 1761  
   master alloys 448  
   ores 1022, 1763  
   spinel 1764  
 Chromium(III) acetate 1786  
 Chromium alum 1106  
 Chromium(III) aquoxides 1777  
 Chromium(III) chloride 1786  
 Chromium-coated steel 359  
 Chromium(II) compounds 1792  
 Chromium dioxide 1779, 1796, 1806  
 Chromium(III) fluoride 1785  
 Chromium hydroxide 1777  
 Chromium lignosulfonates 1787  
 Chromium-molybdenum master alloys 449  
 Chromium-niobium 472  
 Chromium-niobium master alloys 449  
 Chromium(III) nitrate 1786  
 Chromium nitrides 448  
 Chromium oxide pigments 1797  
 Chromium(III) oxide pigments 1777  
 Chromium oxides 413, 1777, 1797, 1800  
 Chromium phosphate 1807  
 Chromium(III) phosphate 1787  
 Chromium rutile yellow 1156  
 Chromium(III) salts 1782

Chromium(III) sulfate 1783  
 Chromium trioxide 1780  
 Chromyl chloride 1779, 1792  
 Chrysene 1057  
 Chrysoberyl 961  
 Chrysocola 498  
 Cinnabar 893, 895, 911  
 Circofer process 118  
 Circored process 117  
 Cladding 362  
 Classification of coal 199  
 Classification of TiO<sub>2</sub> pigments 1150  
 Clathrasils 1969  
 Claus process 1099  
 Clay activation 1119  
 Clay depressants 1275  
 CLEAR process 529  
 Clinobisvanite 863  
 Coagulant 150  
 Coal 191  
   carbonization 211  
   classification 199  
   coking 210  
   combustion 215  
   conversion 210  
   dewatering 207  
   for smelting-reduction processes 123  
   gasification 210, 213  
   hydrogenation 212  
   liquefaction 210, 212  
   mineral matter content 219  
   organic components 200  
   petrology 191  
   pyrolysis 191, 211, 224  
   thermoplastic properties 224  
 Coal tar 215  
 Coal tar pitch 253  
 Coalification 193-196  
 Coarse quartz 1911  
 Coating of silver sulfide 1220  
 Coating systems 361  
 Cobalt 5, 923, 1370  
   as a catalyst 945  
   corrosion 937  
   electroplating 947  
   electrowinning 743  
   extraction 743  
   from arsenide ores 933  
   from laterite ores 933  
   from nickel ores 770  
   in igneous rocks 928  
   in ZnS lattice 670  
   powders 936  
   separation from other metal ions 933  
 Cobalt acetate 944  
 Cobalt(II) acetate 942

Cobalt alum 1106  
 Cobalt arsenide minerals 930  
 Cobalt blue 944, 950  
 Cobalt boron 469  
 Cobalt(II) carbonate 942  
 Cobalt carbonyl complexes 940  
 Cobalt carbonyls 934, 939  
 Cobalt carboxylates 935  
 Cobalt(II) carboxylates 943  
 Cobalt(II) chloride 942  
 Cobalt(II) complexes 938  
 Cobalt(II) compounds 938  
 Cobalt(III) compounds 938  
 Cobalt Development Institute 19  
 Cobalt(II) dicobalt(III) tetroxide 940  
 Cobalt fluoride 946  
 Cobalt hydroxide 938  
 Cobalt(II) hydroxide 941  
 Cobalt(III) hydroxide 741, 748  
 Cobalt ion reduction 935  
 Cobalt molybdenum-alumina catalysts 1100  
 Cobalt(II) nitrate 942  
 Cobalt(II) oxalate 943  
 Cobalt(II) oxide 935, 938, 940, 948  
 Cobalt(III) oxide 938, 940  
 Cobalt oxides 940  
 Cobalt(III) pentammine complex 931  
 Cobalt(II) phosphate 942  
 Cobalt sulfamate 947  
 Cobalt(II) sulfate 942  
 Cobalt sulfide 937, 945  
 Cobalt tripotassium hexanitrite 943  
 Cobalt violet 944  
 Cobaltamines 938  
 Cobalt-base superalloys 1375  
 Cobalt-chromium-molybdenum 449  
 Cobalt-containing iron oxide pigments 187  
 Cobalt-containing pigments 944  
 Cobalt-containing plating baths 947  
 Cobaltite 797, 928, 930  
 Cobalt-niobium 472  
 Cobalt-tungsten alloys 947  
 Cobre Nordox 572  
 Cobre Sandoz 572  
 Cochranite 1173  
 COED pyrolysis process 255  
 Coesite 1903, 1904, 1905  
 Coffinite 1606  
 COGAS process 254  
 Coil coating 360  
 Coin process 132  
 Coinage 1251, 1307  
 Coinage alloys 1205, 1223  
 Coke 31, 53

consumption 53  
 microstructure 233  
 Coke oven gas 211  
 Coke oven silica bricks 1917  
 Coke ovens 251  
 Coke properties 252  
 Coking 211  
 Coking of coal 210  
 Colcord process 604  
 Cold press welding 1255  
 Colemanite 466, 468, 1987, 2010, 2016  
 Collectors 2175  
 Colloidal gold 1188  
 Colloidal hydrous ferric oxide 148  
 Colloidal silica 1932, 1945, 1946, 1947  
 Colloidal silica surface 1937  
 Colloidal silica-water system 1943  
 Colloidal silver 1250, 1259  
 Colloidal silver sols 1253  
 Colmonoy 471  
 Color photography 1258  
 Colored gold alloys 1205  
 Colored quartz 1914  
 Coloring of silver 1252  
 Columbite 33, 472, 686, 1404, 1418, 1419  
 Combismelt process 126  
 Commercial forms of nickel 771  
 Compact cassettes 186  
 Complex antimony sulfide ores 833  
 Complex compounds of iron 148  
 Complex iron(II) cyanides 179  
 Complex oxides 33  
 Complex silicides 1374  
 Complex tin concentrates 689  
 Complexation of cations 873  
 Composite metals 1256  
 Composite MgO-C anodes 983  
 Composites 1255, 1256  
 Composition  
   of brines 983  
   of dolomites 983  
   of ferrophosphorus 460  
   of ferrotungsten 461  
   of seawater 1017  
 Compressibility of iron 374  
 Computer control of electric furnaces 438  
 Computer tapes 186  
 Concrete reinforcing steel 473  
 Condensation 2157  
 Condensation of mercury 898  
 Conical cathodes 993  
 Conseil intergouvernemental des pays exportateurs de cuivre 545  
 Conseil international pour le développement du cuivre 545

Constructional steel 1  
 Consumable electrode remelting processes 336  
 Consumable electrodes 1167  
 Consumption of cadmium 880  
 Contact breakers 1256  
 Conterfey 642  
 Contimelt process 531  
 Continuous casting 327  
 Continuous casting of copper 536  
 Continuous converting 521  
 Continuous production of potassium 2155  
 Continuous rod casting 537  
 Contop process 524  
 Control grids 1374  
 Control rods 10, 875  
 Controlled cooling 747  
 Controlled oxidation of Fe<sub>3</sub>O<sub>4</sub> 174  
 Conversion of iron(II) sulfate to gypsum 149  
 Converter gas cleaning 380  
 Converter slags 518, 732  
 Converting 518  
 Cooperite 1276  
 Copper 4, 18  
   alloys, age-hardenable 955  
   amine complexes 567  
   and the environment 569  
   anode slimes 855, 1228, 1229, 1283  
   anodes 534  
   cathodes 532  
   converter 519  
   dross 611  
   electrical conductivity 495  
   electrowinning 741, 742  
   from secondary materials 524  
   grades 539  
   hydrometallurgy 525  
   ions 547  
   matte 833  
   mechanical properties 494  
   minerals 497  
   ore deposits 499  
   pigments 571  
   porphyry ores 1365  
   powder 538  
   refining 529  
   thermal properties 495  
 Copper(I) acetate 563  
 Copper(II) acetate monohydrate 563  
 Copper(II) acetoarsenite 564  
 Copper(II) arsenate 564  
 Copper(II) arsenite 564  
 Copper(II) bis-(1,8-dihydroxyquinoline) 568  
 Copper boron 469  
 Copper(I) bromide 564  
 Copper(II) bromide 564  
 Copper(II) carbonate hydroxide 552



Copper chloride 871  
 Copper chloride complexes 567  
 Copper(I) chloride 528, 553  
 Copper(II) chloride 555  
 Copper(II) chromate(III) 565  
 Copper(II) chromate(VI) 564  
 Copper chromates 1791  
 Copper(I) cyanide 565  
 Copper(I) cyanide complexes 568  
 Copper Development Association 545  
 Copper(II) diphosphate hydrate 566  
 Copper(II) formate 565  
 Copper(II) hydroxide 550  
 Copper indium selenide 1567  
 Copper(I) iodide 565  
 Copper metaborate 2020  
 Copper(II) nitrate trihydrate 565  
 Copper(II) oxalate 566  
 Copper(I) oxide 548  
 Copper(II) oxide 549  
 Copper(II) oxychloride 556  
 Copper(II) phosphate trihydrate 566  
 Copper(II) selenide 566  
 Copper(II) soaps 566  
 Copper(I) sulfate 557  
 Copper(II) sulfate monohydrate 562  
 Copper(II) sulfate pentahydrate 557  
 Copper sulfide 10  
 Copper(I) sulfide 566  
 Copper(II) sulfide 567  
 Copper telluride 1573  
 Copper(II) tetrafluoroborate 567  
 Copper(I) thiocyanate 567  
 Copperas 149  
 Copperas process 173  
 Copperas reds 173  
 Copper-chromium master alloys 449  
 Copper-plate amalgamation process 1224  
 Copper-silicon alloy 527  
 Coprecipitation 1100  
 Cordierite 1028  
 Core of the earth 31  
 Corex process 127, 142  
 Corrosion 364  
 of cobalt 937  
 of stainless steels 366  
 of titanium 1133  
 Corrosion protection 661  
 Corsican forges 275  
 Corundum 1063, 1066  
 Corundum concrete 103  
 Corvusite 1472  
 Cosmetic industry 866  
 Countercurrent decantation 1079

Covellite 498, 1365, 1367  
 Cresol 704  
 Cresolsulfonic acid 704  
 Crevice corrosion 366  
 Cristobalite 1902, 1904, 1908, 1916  
 Cristobalite sand 1917  
 Crocoite 584, 1763  
 Crookesite 1544  
 Crucible steel 279  
 Crucibles 1346  
 Crust breaker 1047  
 Cryogels 1933  
 Cryogenic steels 270  
 Cryolite 1045  
 Cryptocrystalline magnesite 1014, 1022  
 Cryptomelane 1815  
 Crystal growth 50, 1869  
 Crystal silver 1250  
 Crystal structure of iron blue 179  
 Crystalline arsenic 805  
 Crystalline boron 1989  
 Crystalline nonmineral silica phases 1909  
 Crystalline quartzite 1912  
 Crystalline silica phases 1905  
 Crystalline silica products 1911  
 Crystalline silicon 1880  
 Crystallization 739, 742  
 of  $K_2NbF_7$  1406  
 of sodium chloride 2087  
 Cubanite 719  
 Cupellation 1203, 1226, 1227, 1230  
 Cupola furnace 343  
 Cuprasol 572  
 Cupravit-Forte 572  
 Cupravit-Spezial 572  
 Cuprion ammoniacal leach process 1831  
 Cuprite 498  
 Cupronickel coin 716  
 Cuprotungstite 1333  
 Curie 1588  
 Curie temperature 372, 374  
 of  $\alpha$ -iron 376  
 Current efficiency 1050  
 Cutinite 194  
 Cyanidation process 1185, 1190, 1218, 1225  
 Cyanide 1058  
 Cyanide-containing melts 1313  
 Cyanide-insoluble silver compounds 1225  
 Cyano complexes 179  
 Cyanogen 55  
 Cyanogen bromide 1187, 1225  
 Cyclone crystallization 167  
 Cyclone smelting 517, 828  
 Cyclones 97

Cylindrite 686  
 Cymet process 529  
 Czochralski silicon crystal 1869

## D

D'Ansire 2122, 2145  
 D2EHPA 748, 964, 1536, 1716  
 Datolite 1987, 2010  
 Davidite 1606  
 Dawsonite 1093  
*De re metallica* 492, 642, 824  
 Deactivation of alumina catalyst 1100  
 Dead Sea 2153  
 Debismuthizing 610  
 Debismuthizing of lead 2252  
 Decaborane 2000, 2002  
 Decarburization 294, 316, 372  
 Decarburization of high-carbon ferrochromium 445  
 Decolorizing agents 1096  
 Decomposition of carnallite 2169  
 Decomposition of diborane 1990  
 Decomposition points of coal 232  
 Decoppering 604  
 Degussa process 1162, 1309  
 Dehydrated carnallite 984  
 Dehydration 1385  
 of alcohols 1100  
 of aluminum hydroxide 1097  
 of aqueous magnesium chloride 986  
 of *n*-butane 1100  
 of carnallite 988  
 of gypsum 2285  
 of magnesium chloride 984  
 of silica gel 1951  
 Dehydrogenation 316, 1385  
 Dehydrogenation of isopropanol 1258  
 Deicing salt 2093  
 Delft china 944  
 Demag electrolysis 1236  
 Demonetization of silver 1218  
 Denitrifying 372  
 DENOX catalysts 1353  
 Dense-media separation 40, 206  
 Densification cycle 757  
 Densities of ferrotitanium alloys 474  
 Density of mercury 892  
 Dental amalgams 1224  
 Dental materials 1208, 1314  
 Dentifrice 1953  
 Deoxidation 297, 313  
 Deoxidation diagram for Al-Si-O 298  
 Deoxidation of killed steel 474  
 Deoxidized copper 540  
 Dephosphorization 102, 295, 314  
 Deposition of silver alloys 1254  
 Descloizite 1472  
 Desiccants 1952  
 Desilication reaction 1091  
 Desilicization 102  
 Desilvering 608  
 Desilvering of silver-plated material 1239  
 Desulfurization 102, 296, 313, 1000, 2258  
 of coal gas 149  
 of flue gases 2126  
 of petroleum 1384  
 Detergents 1120  
 Determination of boron in ferrobore 470  
 Determination of Sn 706  
 Detinning 21  
 Detinning tin slags 701  
 Deuterium exchange 1959  
 Deutsches Kupfer-Institut 545  
 Dewatering 207  
 Dewatering of coal 207  
 Deyerite 863  
 Dezincing 609  
 Di-(2-ethylhexyl) phosphonic acid 934  
 Di-(2-ethylhexyl) phosphoric acid, see *D2EHPA*  
 Diagenesis 195  
 Dialkylphosphoric acid 1010  
 Dialkylselenium carbamates 1566  
 Diammine silver complexes 1247  
*trans*-Diamminedichloropalladium(II) 1297, 1303  
 Diammonium tetraborate 2017  
 Diamond quartzite 1912  
 Diaphragm cells 830, 2097, 2101  
 Diarsenide ion 34, 164  
 Diarylmercury 915  
 Diaspore 171, 1063, 1065, 1074, 1075  
 Diatomite 1912, 1925, 1927  
 Diborane 1998, 1999, 2000  
 Diborane decomposition 1990  
 Dibutyl carbitol 1196  
 Dibutyltin dichloride 712  
 Dicalcium ferrite 1015  
 Dicalcium phosphate 2192  
 Dicalcium silicate 1015  
 Dicalcium silicate slag 995  
 Dichlorodiamminepalladium(II) 1298, 1300  
 Dickite 34  
 Dicyandiamide 2318  
 Dicyanoaurate complex 1188  
 Die casting 4, 662  
 Diehl process 1187  
 Dielectric layer of  $Ta_2O_5$  1422  
 Dielectric materials 1424  
 Diethyldithiocarbamate 707  
 Dietzel electrolysis 1236

- Diffusion deoxidation 297  
 Diffusion process 1628  
 Difluorosilylene 1893  
 Digenite 498  
 Digermane 1516  
 Digestion of ores 2120  
 Digital audio 186  
 Dilithium tetraborate 2017  
 Dimethylglyoxime 657, 1305  
 Dimethylmercury 915  
 Dinitro-diammineplatinum(II) 1302  
 Diodes 6, 1346  
 Dioptase 498  
 Dioxane 1005, 1009  
 Diphenylamine 704  
 Direct reduction 21, 104, 136, 287  
 Direct rolling 334  
 Dirhenium heptoxide 1496  
 Disadvantage of metallothermic reduction 406  
 Disilane 1885  
 Disilver fluoride 1246  
 Disodium arsenate 820  
 Disodium ethylenediaminetetraacetate 1115  
 Disodium octaborate 2015  
 Disodium tetrasulfide 2058  
 Dispersants 1960  
 Dispersion-hardened platinum 1307  
 Disproportionation 1385  
 Dissolution of silver 1220  
 Distillation  
   of ferromanganese 1827  
   of mercury 906  
   of osmium(VIII) oxide 1295  
   of ruthenium(VIII) oxide 1295  
   under reduced pressure 872  
 Distribution coefficient 1714  
 Disulfide ion 34, 164  
 Disulfide ion autooxidation 164  
 Disulfides 33  
 Disulfites 2234  
 Dithiocarbamates 1383  
 Ditanium trioxide 1171  
 Divalent mercury 910  
 DK process 103  
 Dodecacarbonyltetracobalt 939  
 Dolime 2254  
 Dolomite 13, 983, 1004, 2254  
 Dolomite-magnesia 101  
 Domeykite 815  
 Doré bullion 534  
 Doré furnace 1230  
 Doré metal 1283  
 Double bell system 58  
 Double sulfides 33  
 Doubling period 17  
 Dow cell 992  
 Dow Chemical process 986, 988, 1005  
 Down's process 2155  
 Downdraft sintering 586  
 Downs cell 2041, 2060, 2063  
 Driers 941, 944  
 Drilling muds 547, 2343  
 Drinking water from seawater 1258  
 Dross 1232, 1233, 1279, 1283  
 Dressing 604  
 Dry coke quenching 136, 211  
 Dry scrubbers for controlling cell emission 1057  
 Dry stacking 1089  
 Drying agents 1096  
 Ductile cast iron 2  
 Dump leaching 526  
 Dust catchers 96  
 Dust emission 378  
 Dust-recovery system 96  
 Dyes 215  
 Dyna Whirlpool 40  
 Dysprosium 12
- E**  
 EDTA 1254, 1711, 2287  
 Effect of temperature on precipitation 1082  
 Effect of temperature on silanol groups 1938  
 Effects of chlorine in oxidation 370  
 Efficient operation of blast furnace 61  
 El Teniente converter 519, 520  
 Elastic properties of iron 374  
 Electric arc furnace 308, 425, 475, 1022  
 Electric arc melting 1342  
 Electric batteries 1257  
 Electric furnace smelting 512, 728  
 Electric furnaces 425  
 Electric induction furnace 309  
 Electric slag furnaces 514  
 Electric steel dusts 645  
 Electric steel process 306  
 Electrical conductivity of copper 495  
 Electrical industry 1223  
 Electrical insulator 1026  
 Electrical lamps 9  
 Electrical properties of iron 375  
 Electrical resistivity of aluminum 1043  
 Electrical technology 1255, 1312  
 Electrically conducting TiO<sub>2</sub> pigments 1154  
 Electroceramics 1155  
 Electrochemical apparatus 1308  
 Electrochemical decomposition of sodium sulfate 2129  
 Electrochemical deposition 657

- Electrocrystallization 535  
 Electrodes 215  
 Electrodes made of SnO<sub>2</sub> 711  
 Electrodeposition 1945  
 Electroforming 1208, 1314  
 Electrogravimetry 1307  
 Electrolysis  
   of aqueous solutions of iron(II) salts 143  
   of beryllium chloride 966  
   of magnesium chloride 983  
   of magnesium oxide 983  
   of molten borates 1990  
   of molten lithium chloride 2041  
   of pickle solution 168  
   of sodium chloride 2096  
 Electrolysis cell 1748  
 Electrolytic capacitors 1418  
 Electrolytic coating 356  
 Electrolytic copper powder 539  
 Electrolytic deposition of cadmium 872  
 Electrolytic detinning 705  
 Electrolytic galvanizing 662  
 Electrolytic manganese 406  
 Electrolytic manganese dioxide 1843  
 Electrolytic oxidation of nickel(II) hydroxide 741  
 Electrolytic production of zinc 658  
 Electrolytic production of zinc dust 653  
 Electrolytic reduction of silver nitrate solutions 1250  
 Electrolytic refining 1218  
 Electrolytic refining of lead 613  
 Electrolytic route to manganese 1823  
 Electron beam melting 1372, 1412, 1440, 1464  
 Electron beam refining 1461  
 Electron beam remelting 338  
 Electron beam welding 1168  
 Electron beam zone melting 1342  
 Electron emitters 1678  
 Electronic applications of cultured quartz 1915  
 Electronic tubes 1346  
 Electronics industry 1223, 1254, 1312  
 Electroplating 4, 12, 356, 1208, 1772  
 Electroplating industry 1279  
 Electroplating of cobalt 947  
 Electrorefining 24  
   of silver 1227  
   of tin 704  
   of zirconium 1440  
 Electro-slag remelting 338  
 Electrostatic concentration 40  
 Electrostatic precipitators 98  
 Electrostatic separation 2180  
 Electrostatic separation of kieserite 1031  
 Electrothermal process for manganese 1826  
 Electrowinning 527  
   of hafnium 1464  
   of manganese 1824  
   of nickel 750  
   of titanium 1165  
   of zinc 653  
   of zirconium 1440  
*Electrum magicum* 1185  
 Elemental silicon 1886  
 Elemental silver 1224  
 Elemental sulfur 655, 703  
 Elemental sulfur from pyrrhotite 165  
 Elred process 126  
 Eluex process 1615, 1616  
 Elution with organic solvents 1194  
 Embalming 1105  
 Embolite 1221  
 Emeleusite 1914  
 Emerald 961  
 Emergency batteries 1257  
 Emission control 545  
 Emulsion breaker 665  
 Enamel industry 1110  
 Enameling of steel 944  
 Enamels 663, 941, 1923  
 Enargite 498, 797  
 Energy saving 21, 437  
 English cupellation furnace 1228  
 Engraving 149  
 Enrichment of <sup>235</sup>U 1627  
 Enstatite 1028  
 Environmental aspects of nickel smelting 732  
 Environmental aspects of steel production 377  
 Environmental protection 132  
 Environmental protection in ferrochromium production 453  
 Eosite 1363  
 Epitaxy 1877  
 Epsom salt 1019, 1023, 1030, 1031  
   from langbeinite 1032  
   from magnesite 1032  
   from seawater 1032  
 Epsomite 1007, 1030, 2145, 2161, 2193  
 Equilibrium data for iron pentacarbonyl 155  
 Erbium 12  
 Erbium earths 1695  
 Erythrite 928  
 Eschka's gravimetric method 906  
 Esterified silica surface 1938  
 Etchant for aluminum 149  
 Etching 152  
 Etching solutions 568  
 Etherification 1385  
 Ethyl process 1865  
 Ethylene 241  
 Ethylene glycol 1009

Ethylenediaminetetraacetic acid, *see* EDTA  
 Ettringite 2286  
 Euclase 961  
 Euclite 1434  
 Eucryptite 1902, 2033  
 Eudialyte 1434, 1435  
 Eugenite 1221  
 Eukryptite 2033  
 Europium 12  
 Europium oxide separation 1722  
 Euxenite 1405, 1419, 1655, 1698  
 Evaporation  
   of brine 2089  
   of magnesium chloride solutions 1010  
   of seawater 1007, 2086  
 Evaporative cooler 2125  
 Exhaust-gas catalysts 1311  
 Exinite 193  
 Expansion coefficient of iron 373  
 Explosion hazards and alloy formation 1320  
 Explosion hazards of silver compounds 1264  
 Explosive antimony 823  
 Explosive cladding 1169, 1255  
 Explosive silver compounds 1247  
 Extenders 1921, 1922  
 Extenders for sylvite flotation 2175  
 External scrap 21  
 Extraction 18  
   of silver from gold ores 1223, 1232  
   of silver from tin ores 1232  
 Extrusion dies 1374  
 Exudatinitite 194

## F

Faber du Faur furnace 613  
 Factors influencing recycling 385  
 Falcondo ferronickel process 458  
 Faraday's law 989, 1050  
 Fatty alcohol sulfates 1031  
 Fatty amines 1008  
 Fehling's solution 568  
 Feldspar 2202  
 Felsparazit 1912  
 Ferberite 462, 1334  
 Fergusonites 1405, 1419, 1698  
 Ferric alums 148  
 Ferric arsenate precipitates 165  
 Ferric chloride 148, 150  
 Ferric compounds 147  
 Ferric ion hydrolysis 166  
 Ferric molybdate 1384  
 Ferric oxide 50  
 Ferricyanide complex 148  
 Ferrimagnetic  $\gamma$ -Fe<sub>2</sub>O<sub>3</sub> 173

Ferrimagnetic iron oxide 185  
 Ferrimolybdate 1363  
 Ferrite-based permanent magnets 40  
 Ferrites 177  
 Ferritungstite 1333  
 Ferroalloy metals 3, 12  
 Ferroalloys 404  
 Ferroboration 404, 414, 465  
 Ferrochromium 404, 438, 449, 450, 1769  
   by Perrin process 447  
   by Simplex process 447  
   consumption 453  
   dust emissions 454  
 Ferrocolumbium, *see* Ferroniobium  
 Ferrocyanides 148  
 Ferroelectric materials 2048  
 Ferroelectric perovskites 1409  
 Ferroelectric single crystals 1424  
 Ferromanganese 404, 420, 1814, 1835  
   distillation 1827  
   electric arc furnaces 430  
 Ferromolybdenum 404, 412, 414, 477, 1493  
 Ferronickel 32, 404, 454, 758, 760, 762  
   refining 459  
   smelting 770  
 Ferroniobium 404, 414, 472, 1405, 1413  
 Ferroniobiumtantalum 404  
 Ferrophos 189  
 Ferrophosphorus 404, 460  
 Ferroselenium 404  
 Ferrosilicochromium 404, 439, 449, 451  
 Ferrosilicomanganese 404  
 Ferrosilicon 404, 415, 993, 995, 1890  
 Ferrosilicon-aluminum alloy 481  
 Ferrosilicon-titanium alloys 474  
 Ferrosilicozirconium 404  
 Ferrotitanium 404, 414, 473  
 Ferrotitanium-silicon 475  
 Ferrotungsten 404, 412, 414, 460  
   carbothermic production 464  
   composition 461  
   from scheelite 465  
 Ferrous carbonate 164  
 Ferrous chloride 153  
 Ferrous compounds 147  
 Ferrous halides 147  
 Ferrous hydroxide 147  
 Ferrous ion oxidation 165  
 Ferrous metals 1  
 Ferrous oxalate 162  
 Ferrous oxide 162  
 Ferrous sulfate 147  
 Ferrous sulfide 33, 147  
 Ferrovanadium 404, 414, 476, 1477, 1486  
 Ferroxyhite 1830

Ferrozirconium 404  
 Ferrum 31  
 Fertilizers 12, 13, 149, 1024  
   for acidic soil 2203  
   for vines 184  
 Feuerstein 1912  
 Fick's law 300  
 Fillers 1096, 1921, 1922, 1931  
 Film coatings 361  
 Findlingsquarzit 1912  
 Fior process 116  
 Fire assay 1203  
 Fire extinguisher powders 2204  
 Fire refining 529  
 Fire retardants 6, 2203  
 Fireclay 1916  
 Fire-resistant ceramic products 1116  
 Fisan silver powder 1252  
 Fischer-Tropsch synthesis 946  
 Fission 11  
 Fixed carbon 218  
 Flake zinc pigments 679  
 Flame hydrolysis 1954  
 Flame retardants 840, 1025, 1033  
 Flash calciner 1086  
 Flash converting 521  
 Flash evaporation 1088  
 Flash smelting 730  
 Flash smelting furnaces 505  
 Flat set 530  
 Flints 1733, 1912  
 Float-zone crystal growth 1871  
 Flocculant 1079  
 Flocculating agents 152, 153  
 Flotation 24, 40, 207, 1190, 2154, 2174  
   equipment 2177  
   of kieserite 1031  
   of potash ores 2179  
   of potassium chloride 2176  
   of primary tin ores 688  
 Flue dust 55  
 Flue gas desulfurization 2126, 2275  
 Fluid dynamics in Al cell 1052  
 Fluid-bed dry scrubbing 1094  
 Fluidized-bed  
   electrolysis 905  
   processes 115, 646  
   reactors 505, 725  
   regeneration of pickling solution 168  
 Fluoboric acid 613  
 Fluorapatite 13  
 Fluorescent macerals 194  
 Fluorescent materials 871  
 Fluorescent tubes 1346  
 Fluoride in drinking water 1099

Fluoride-crystallization 170  
 Fluorinating agents 941  
 Fluorination catalysts 1424  
 Fluorinite 194  
 Fluoroanhydrite 2290  
 Fluoroborates 1997  
 Fluoroboric acid 1995, 1996, 1997  
 Fluorobromosilicon hydrides 1894  
 Fluorocarbon compounds 1050  
 Fluorosilicate fusion of zircon 1436  
 Fluorotitanates 1172  
 Fluorspar 687  
 Fluosilicic acid 613  
 Flux for welding 663  
 Fluxes 409  
 Fly ashes 1473  
 Foamers 2175  
 Foil 18  
 Forging dies 1374  
 Formation  
   of intermetallic compounds 410  
   of magnetite 518  
   of silicon carbide 418  
   of whiskers 50  
 Formic acid 2126  
 Forsterite 983, 1015, 1027  
 Foundry iron 140  
 Foundry technology 1923  
 Fountain pen nibs 1278  
 Fractional crystallization 1055, 1710  
 Francevillite 1472  
 Francium 12, 1592  
 Franckeite 686  
 Frank-Caro process 2317  
 Franklinite 645  
 Free energy change  
   in oxide formation 407  
   in reduction of oxides by aluminum 408  
   in reduction of oxides by silicon 408  
 Free flow agents 1961  
 Freibergite 1221  
 Freieslebenite 1221  
 Frequency doublers 1409, 1424  
 Frequency filters 1424  
 Friction igniters 1733  
 Friedel-Crafts catalyst 1113  
 Friedel-Crafts syntheses 152, 1111  
 Fuel element cans 1413  
 Fuel injection in blast furnace 62  
 Fulminating gold 1200, 1201  
 Fulminating silver 1248  
 Fungicides 6, 184, 546, 666  
 Fungurani 572  
 Fused alumina 1101

Fused barium sulfide 670  
 Fused magnesia 1026  
 Fused magnesium oxide 1026  
 Fused zircon sand 1028  
 Fused-salt electrolysis 1725, 1745  
 Fusible alloys 845, 858  
 Fusible indium alloys 1538  
 Fusinite 195  
 Fusion of baddeleyite 1437

**G**

Gabbro 1070  
 Gadolinite 1697  
 Gadolinium 12  
 Galena 584  
 Galfan 355  
 Gallium 10, 25, 846, 1069, 1523  
 content of  $Al_2O_3$  1084  
 Gallium alkyls 1530  
 Gallium alum 1106  
 Gallium arsenide 815, 837  
 Gallium bromide 1528  
 Gallium(II) chloride 1529  
 Gallium(III) chloride 1528  
 Gallium fluoride 1528  
 Gallium hydride 1530  
 Gallium hydroxide 1529  
 Gallium iodide 1528  
 Gallium nitrate 1529  
 Gallium nitride 1529  
 Gallium oxide hydrate 1529  
 Gallium(III) oxide 1529  
 Gallium sulfate 1529  
 Gallium(II) sulfide 1529  
 Gallium triethyl 1530  
 Galvalume 355  
 Galvanizing 643, 661, 668  
 Galvanizing baths 666  
 Galvannealed 355  
 Gamma-ray spectroscopy detectors 1515  
 Ganister 1911, 1912  
 Garnet 1656  
 Garnierite 719, 758  
 Gas cleaning 437  
 Gas discharge lamps 1346  
 Gas sensors 1312  
 Gas turbine 5  
 Gas turbine components 473  
 Gaseous products in coal pyrolysis 240  
 Gaseous SiO 418  
 Gasification of coal 210  
 Gasoline additives 4, 620  
 Gaylussite 2106

Gécamines process 932  
 Gelatinous aluminum hydroxide 1097  
 Gemstones 961, 1921  
 Genesis of bauxites 1070  
 Geology of potash deposits 2146  
 German cupel 1228  
 German Salt Museum 2074  
 German silver 4, 5, 1253  
 Germanates 1507, 1517  
 Germane 1518  
 Germanic acid 1517  
 Germanides 1507  
 Germanite 1507, 1524  
 Germanium 10, 654, 846, 1505  
 Germanium(II) bromide 1518  
 Germanium(II) chloride 1518  
 Germanium dioxide 1506, 1517  
 Germanium disulfide 1507, 1517  
 Germanium halides 1507  
 Germanium(IV) halides 1516  
 Germanium hydrides 1515, 1518, 1519  
 Germanium(II) iodide 1518  
 Germanium monoxide 1506  
 Germanium organometallic compounds 1507  
 Germanium(II) oxide 1518  
 Germanium oxychloride 1516  
 Germanium selenides 1518  
 Germanium(IV) sulfate 1517  
 Germanium(II) sulfide 1518  
 Germanium tetrabromide 1517  
 Germanium tetrachloride 1516  
 Germanium tetrafluoride 1516  
 Germanium tetraiodide 1517  
 Gersdorffite 719, 797, 928  
 Geyserite 1912  
 Gibbsite 1062, 1063, 1068, 1072, 1074, 1109  
 Gibbsite bauxite 1075  
 Gilding 1188, 1208  
 Gittinsite 1434  
 Glaserite 2122, 2145, 2154, 2161, 2195  
 Glass crystallization method 189  
 Glass industry 815, 1033, 1308, 2203  
 Glasses 943, 1551, 1923  
 Glass-melting furnaces 1375  
 Glauber's salt 2122, 2145, 2162  
 Glauberite 2122, 2127, 2145  
 Glauco-dot 928  
 Glazes 663, 1923  
 Glue 704  
 Goethite 171, 172, 190, 719, 767, 1069, 1084, 1830  
 Goethite process 655  
 Gold 8, 18, 1183, 1280  
 alloys 1202, 1204  
 amalgam 909

bronze pigments 572  
 coins 1204  
 compounds 1199  
 deposits 1188  
 foil 906  
 in electronics 1207  
 in medicine 1186  
 leaf 1209  
 plating 1207  
 recovery from surface-coated materials 1198  
 recovery from sweeps 1197  
 refining 1194  
 separation from silver 1185  
 solders 1205  
 Gold(I) acetylide 1202  
 Gold aurates 1187  
 Gold(I) chloride 1202  
 Gold(III) chloride 1202  
 Gold(I) complexes of diphosphines 1202  
 Gold(I) cyanide 1202  
 Gold(III) hydroxide 1200-1202  
 Gold malate 1202  
 Gold mercaptides 1202  
 Gold(III) oxide 1202  
 Gold ruby glass 1201  
 Gold(III) selenate 1202  
 Gold sulfides 1202  
 Gold sulforesinates 1202  
 Gold thiosulfate 1202  
 Gold-copper alloys 1197, 1207  
 Gold-copper-nickel alloys 1207  
 Gold-germanium alloys 1207  
 Gold-manganese alloys 1207  
 Gold-nickel alloys 1207  
 Gold-palladium alloys 1207  
 Gold-palladium gauze 1209  
 Gold-platinum alloys 1208  
 Gold-rich alloys 1197  
 Gold-silicon alloys 1207  
 Gold-silver alloys 1197, 1284  
 Gold-silver-copper alloys 1202, 1207  
 Gold-silver-palladium alloy 1208  
 Gold-tin alloys 1207  
 Gossan 36  
 Grades of titanium 1131  
 Granular quartz 1917, 1920  
 Granulated kieserite 1031  
 Granulated potassium chloride 2187  
 Graphex 2031  
 Graphite 101  
 Graphite retorts 675  
 Gravity concentration 1189  
 Gravity separators 40  
 Gray iron 341  
 Gray tin 684

Great Salt Lake 2153  
 Green vitriol 149  
 Greenockite 870  
 Grey cast iron 2, 146  
 Grignard reagents 915, 1003, 1009  
 Grignard syntheses 998, 1000  
 Grinding aluminum powder 1122  
 Grindstones 1012  
 Growth rate 16  
 Guignet's green 1778  
 Gummite 1606  
 Gutzeit arsenic test 814  
 Gypsum 13, 656, 2145, 2281  
 Gypsum dehydration 2285  
 Gypsum plaster 2305

**H**

Hafnium 10, 1000, 1459  
 electrowinning 1464  
 metal powder 1465  
 production 1461  
 Hafnium boride 1467  
 Hafnium carbide 1466, 1467  
 Hafnium dichloride oxide 1467  
 Hafnium hydride 1468  
 Hafnium hydrous oxide 1460  
 Hafnium iodide 1464  
 Hafnium nitride 1468  
 Hafnium oxide 1466, 1468  
 Hafnium tetrabromide 1468, 1469  
 Hafnium tetrachloride 1466, 1467, 1469  
 Hafnium tetrafluoride 1467  
 Hafnium tetrahydroborate 1467  
 Hafnium-free zirconium 1431, 1462  
 Hafnium-zirconium alloys 1466  
 Halite 2145, 2174  
 Halkyn process 603  
 Hall generators 1539  
 Hall-Héroult cell 1046, 1072  
 Haloantimonates 837  
 Halogen lamps 1346  
 Halogenosilanes 1886  
 Halostannates(IV) 710  
 Halox Zinc Phosphate 678  
 Hanksite 2106, 2122  
 Hard coal 220  
 Hard metal alloys 936  
 Hard metals 1345, 1355  
 Hargreaves process 2129, 2192  
 Harike process 559  
 Harris process 604, 607, 832  
 Hastelloys 1301  
 Hatchite 1544  
 Hausmannite 1815

Hazelett casting system 531  
 Hazelwoodite 32, 719  
 Heap leaching 526  
 Heat balance in Al cell 1051  
 Heat economy system 100  
 Heat treatment of beryl 961  
 Heating elements 1346  
 Heats of formation  
 of compound oxides 410  
 of intermetallic compounds 410  
 of oxides 407  
 Heat-storage medium 1023  
 Heat-transfer medium 2069  
 Heavy-media separation 2182  
 Hectorite 2034  
 Hematite 33, 166, 171, 172, 1084  
 Hematite enrichments 37  
 Hematite iron 140  
 Hematite process 656  
 Hematite-quartzite ores 38  
 Hematological effects of lead 625  
 Hemimorphite 644  
 Henry's law 497  
 Heraklith 1024  
 Herbicides 6, 815  
 Hercynite 1764  
 Herzenbergite 686  
 Hessite 1221  
 Heterocyclic sulfur compounds 205  
 Heterogenite 928  
 Heteropolymolybdates 1382, 1383  
 Heteropolytungstates 1351  
 Heucophos 678, 1121  
 Hexacarbonylchromium 1792  
 Hexachlorodisilane 1892  
 Hexachlorodisiloxane 1893  
 Hexachloroiridic(IV) acid 1304  
 Hexachloroplatinates 1299, 1302  
 Hexachloroplatinic(IV) acid 1301, 1314  
 Hexachlororhodic(III) acid 1303  
 Hexachlororuthenate(III) 1295  
 Hexachlororuthenic(III) acid 1314  
 Hexachlorosilane 1885  
 Hexachlorozirconates 1448  
 Hexacyanocobaltates(III) 939  
 Hexagonal ferrites 188  
 Hexahydroxyantimonates 839  
 Hexamethylenetetramine 1005  
 Hexamethylenimine 2202  
 Hexanitritocobaltates(III) 939  
 Hexavalent chromium compounds 1796  
 Heyrowski reaction 364  
 Hieber reaction 154  
 Higgins column 1615

Higgins furnace 1027  
 High-carbon ferrochromium 438, 442  
 High-carbon ferromanganese 423  
 High-intensity dry magnetic separators 40  
 High-purity aluminum 1054  
 High-purity arsenic 806  
 High-purity magnesium 999  
 High-purity quartz 1920  
 High-purity tungsten 1348  
 High-speed steels 461, 1345  
 High-temperature alloys 4, 936  
 High-temperature electrolysis 1313  
 High-temperature steels 369, 1345  
 High-tungsten tin concentrates 695  
 High-vacuum distillation furnace 1672  
 Himsley column 1615  
 Hismelt process 131  
 Hispacil 1947  
 Hispafos 678  
 Hoboken converter 519, 520  
 Hofmann-Sand reaction 915  
 Höganäs process 114  
 Holmium 12  
 Horizontal crystallizer 2172  
 Horizontal retorts 649  
 Horizontal strand casting 333  
 Hornstein 1912  
 Hot blast stoves 102  
 Hot metal 52, 283  
 Hot pressing 968  
 Hot-dip coating 351  
 Hot-metal mixer 52  
 Howlite 1987  
 HSLA steels 471, 473  
 Hübnerite 462, 1334  
 Hulsite 686  
 Humboldt continuous copper refining 531  
 Humic acids 1085  
 Humphreys' spiral 40  
 Hunter process 1162, 2057, 2068  
 Huntite 1004, 1014  
 Hutchinsonite 1544  
 Huttonite 1655  
 Hybinette process 746  
 Hydrargillite 1062, 1063, 1110  
 Hydrate isomerism 1783  
 Hydrated chromium(III) oxide 1778  
 Hydrated iron oxides 33  
 Hydrated manganite 1839  
 Hydrated tantalum oxide 1424  
 Hydrazine 1283  
 Hydroboracite 1987  
 Hydroboration 2000  
 Hydrobromic acid 1287

Hydrocassiterite 686  
 Hydrochloric acid by-product 1019  
 Hydrochloric acid pickling solutions 168  
 Hydrochloric acid-bromine mixtures 1286  
 Hydrochloric acid-chlorine mixtures 1286  
 Hydrochlorination of ethanol 665  
 Hydrocyclones 41  
 Hydrofluoric acid 1423  
 Hydrofluoric acid pickling solutions 169  
 Hydrofluorination 1623  
 Hydrogen 241  
 in coal 205  
 overvoltage 659  
 storage 1752  
 Hydrogen attack 372  
 Hydrogen chloride dehydration 987  
 Hydrogen chloride process 1093  
 Hydrogen cyanide 55  
 Hydrogen embrittlement 367  
 Hydrogen fluoride 1057  
 Hydrogen fluoride adsorption 1094  
 Hydrogen peroxide production 1099  
 Hydrogen reduction 757  
 Hydrogen selenide 885, 1563, 1567  
 Hydrogen sulfide 739, 765  
 Hydrogen telluride 1576, 1579  
 Hydrogenation 1385  
 Hydrogen-induced cracking 364  
 Hydrogenolysis 1385  
 Hydrolysis  
 of ferric ion 166  
 of titanium sulfate 1142  
 of trichlorosilane 1897  
 Hydromagnesite 1014  
 Hydrometallurgy  
 of copper 525  
 of nickel concentrates and mattes 737  
 of nickel oxide ores 763  
 of zinc 652  
 Hydrophobic agent 1116  
 Hydropyrolysis 247, 254  
 Hydrosulfit 2242  
 Hydrothermal barium ferrite 189  
 Hydrothermal crystallization 177  
 Hydrothermal growth of quartz 1923  
 Hydrothermal reactions 1189  
 Hydrothermal reactor 186  
 Hydrothermal solubility of quartz in water 1908  
 Hydrous ferric oxide 148  
 Hydrous zirconium oxide 1447, 1462  
 Hydrox 572  
 Hydroxylamine 2126  
 Hydroxylated colloidal silica 1935  
 Hydroxyquinolines 1536  
 Hydrozincite 645

HyL process 114

## I

Iceland spar 2254  
 Idiomorphic quartz 1917  
 IG Farben cell 990  
 IG Farben process 984  
 Ilmenite 33, 34, 103, 149, 474, 1134, 1136, 1172, 1444, 1656  
 Ilsemanite 1363  
 Imperial smelting process 585, 595, 650, 871  
 Import and export of pig iron 141  
 Impurities in ferronickel 459  
 Impurities in the electrolyte 659  
 In situ leaching 500, 526  
 Incandescent lamps 1346  
 Incandescent mantles 1743  
 Incendiary bombs 415  
 Inclusions by deoxidation 322  
 INCO flash smelting 515  
 INCO matte separation 735  
 Increased blast temperature 61  
 Inderite 1987  
 Indian laterite ore 41  
 Indium 10, 808, 1531  
 Indium alum 1106  
 Indium antimonide 1538  
 Indium arsenides 815, 1538  
 Indium dichloride 1537  
 Indium hydroxide 1537  
 Indium orthoborate 1537  
 Indium oxides 1537  
 Indium phosphide 1538  
 Indium trichloride 1537  
 Induction furnace 476  
 Induction furnace linings 1028  
 Industrial alumina 1095  
 Inertinite 193, 194  
 Information processing 1207  
 Infrared detectors 6  
 Ingot casting 323  
 Ingot killed steel 327  
 Ingot steel 280  
 Inks 149  
 Inquartation 1185, 1194, 1197  
 Inred process 126  
 Insecticides 6, 546, 815  
 Inspiration converter 519, 520  
 Insulating material 1027  
 Insulators 1931  
 Intercalation compounds 2158  
 Interdendritic microsegregation 320  
 Intergranular attack 1442  
 Intermediate-frequency filters 1424

Intermetallic compounds 702, 837  
 Internal silanols 1936  
 International Bauxite Association 1090  
 International Copper Association 19  
 International Copper Research Association 545  
 International Lead-Zinc Research Organization 19  
 Inyoite 1987  
 Iodargyrite 1221  
 Iodite 1221  
 Ion exchange 470, 527, 657, 873, 1340, 1462, 1614, 2039, 2196, 2202  
 Ion exchange chromatography 1289  
 Ion-exchange membranes 1200  
 Ion-exchange resin for spent pickling solution 171  
 Ion exchange with chelating agents 1711  
 Ion exchangers 905, 1259, 1494  
 Ion plating 1255  
 Ionic structure of molten cryolite 1048  
 Ionium 1650  
 Iridium 1280  
   compounds 1304  
   purification 1298  
 Iridium alum 1106  
 Iridium(III) chloride 1304  
 $\alpha$ -Iron  
   Curie temperature 376  
   lattice constant 375  
 Iron  
   allotropic forms 143  
   atomic volume 373  
   cast 341  
   cast, alloyed 342  
   cast, white 342  
   cast, with vermicular graphite 342  
   complex compounds 148  
   compounds 147  
     for treatment of anemia 161  
     solid-state reactions 173  
   compressibility 374  
   elastic properties 374  
   electrical properties 375  
   expansion coefficient 373  
   from ilmenite 103  
   from pyrite cinder 102  
   gray 341  
   magnetic properties 374  
   malleable 342  
   meteoric 274  
   molar heat capacity 373  
   native 274  
   ores 53  
   Osemund 276  
   oxidation 368  
   pure 372  
   removal 743  
   specific heat capacity 373  
   spheroidal graphite cast 341

sponge 283, 286  
 sulfidation 370  
 tellurian 274  
 thermal conductivity 375  
 Iron acetates 160  
 Iron alum 1106  
 Iron(III) ammonium citrate 160, 161  
 Iron(II) ammonium oxalate 143  
 Iron(II) ammonium sulfate 149  
 Iron(III) arsenate 691  
 Iron blast furnace 57  
 Iron blue pigments 179, 181  
 Iron(III) bromide 160  
 Iron carbide process 116  
 Iron(II) carbonate 160  
 Iron carbonyl 143, 153, 752  
   as antiknock agent 154  
   hydride 154  
   oxidation 158  
 Iron chloride in water treatment 152  
 Iron(II) chloride 153  
 Iron(III) chloride 150  
   as a chlorinating agent 152  
   hexahydrate 151  
   solution 161  
 Iron chlorosulfate 152  
 Iron chromates 1791  
 Iron citrates 160  
 Iron content of  $Al_2O_3$  1084  
 Iron dextran 161  
 Iron disulfide 34  
 Iron(III) fluoride 160  
 Iron(II) fumarate 161  
 Iron(II) gluconate 161  
 Iron halides 160  
 Iron hexacyanoferrate(II) 1104  
 Iron(II) hexacyanoferrate(II) 179  
 Iron(II) hydrogen carbonate 33  
 Iron(II) hydroxide 162  
 Iron(III) hydroxide 162, 748  
 Iron(III) maltol 162  
 Iron monosulfide 33  
 Iron nitrates 160  
 Iron ore beneficiation 39  
 Iron ore production 36, 138  
 Iron ore reserves 36  
 Iron ore sinters 47  
 Iron oxide as an extender 678  
 Iron oxide hydroxide 163  
 Iron oxide magnetic pigments 185  
 Iron oxide pigments 150, 171, 173  
 Iron oxide reduction 49  
 Iron(III) oxide hydrate 33  
 Iron(III) oxide pigments 152

Iron oxide-mica pigment 189  
 Iron passivation 1805  
 Iron(II) phosphate 144  
 Iron phosphide 189  
 Iron(II) phthalocyanine 161  
 Iron pigments 149  
 Iron silicides 416  
 $\gamma$ -Iron solid solutions 376  
 Iron sorbital 161  
 Iron(II) succinate 161  
 Iron sulfate 1142  
 Iron(II) sulfate 149, 161, 1147  
 Iron(III) sulfate 150  
   alums 150  
 Iron(II) sulfide 33  
 Iron technical varieties 146  
 Iron(II) titanate 1172  
 Iron whiskers 158  
 Iron-boron alloy 465  
 Iron-carbon alloys 145  
 Iron-free aluminum sulfate 1096  
 Iron-nitrogen compounds 144  
 Irradiation of silanes 1886  
 Isasmelt process 597, 600  
 Ishizuka cell 992  
 Isomerization 1385, 2157  
 Isopolymolybdates 1382  
 Isopolytungstates 1351  
 Isopropyl borate 2159  
 Isopropylamine 2200  
 Isotope separation 2043  
 Isotropic exchange 1385  
 Itabirite 35, 37, 38

## J

Jacobsite 1815  
 Jamesonite 584, 825  
 Jarosite process 654, 742  
 Jasper 1912  
 Jet aircraft 5  
 Jet engine 7  
 Jewelry 8, 1307  
 Jewelry gold 1204  
 Jigs 206  
 Jollivet-Penarroja process 610  
 Jordisite 1363  
 Josephinite 32

## K

Kainite 983, 1007, 1024, 1030, 2144, 2145, 2154, 2161, 2175, 2191  
 Kaldo converter 520, 699  
 Kaliforschungs-Institut 2160

Kalium 2142  
 Kalsilite 1902  
 Kaolinite 34, 1070, 1091, 1119  
 Kaolinitic sandstones 1070  
 Karst bauxites 1070  
 Kauritil 572  
 Kawasaki process 130  
 Keatite 1905, 1909  
 Kelex 100 1536  
 Kermesite 825, 839  
 Kernite 1987, 2010, 2059  
 Kieselguhr 1912, 1925, 1927, 1928  
 Kieselschiefer 1912  
 Kieserite 983, 1006, 1007, 1019, 1024, 1030, 1034, 2145, 2152, 2165, 2174, 2175, 2193  
   electrostatic separation 1031  
   flotation 1031  
   in fertilizers 1033  
   solubility 1030, 2165  
 Killed steel 325  
 Kinetics of heterogeneous reactions 299  
 Kinetics of precipitation 1081  
 Kinglor-Metor process 114  
 Kiss process 1218  
 Kittquartzit 1912  
 KIVCET cyclone smelting 516, 597, 598  
 Klystron 1374  
 Kobold 925  
 Kocide 101 572  
 Koehlinite 1363  
 Koenerite 2145  
 Kolm 1607  
 Konite 2242  
 Kowa-Seiko process 103  
 Kroll process 991, 1000, 1162, 1439, 1463, 1464, 1672, 2057  
 Kroll-Betterton process 604, 851, 2252  
 Krupp Codir process 119  
 Krupp-Renn process 758  
 Kryptomaceral 193  
 KS process 306  
 Kunzite 2033  
 Kupfer Nickel 716  
 K-White 1121

## L

Lacquers 1772  
 Lactose 1031  
 Ladle furnace 315  
 Lambda probes 1312  
 Lamellar silicates 1015  
 Langbeinite 983, 1006, 1007, 1030, 1034, 2145, 2152-2154, 2175, 2194, 2212  
 Lange-Mond process 753

- Lansfordite 1003  
 Lanthanide contraction 1701  
 Lanthanides 12, 18, 1695, 1700  
 Lanthanum 12, 1749  
 Lanthanum borate glasses 1424  
 Lapis lazuli 1116  
*Lapis magnes* 1813  
 Lascas 1919, 1920  
 Laser beam welding 1344  
 Laser diodes 1539  
 Laser isotope separation 1631  
 Laser technology 1346  
 Lasers 6  
 Laterite 33  
 Lateritic deposits 929  
 Lattice constant of  $\alpha$ -iron 375  
 Laux process 173, 176  
 Laves phases 1482  
 Law of supply and demand 18  
 Lawrencite 153  
 Le Blanc process 2115, 2131, 2202  
 Leaching 526  
   of chalcopyrite 152  
   of oxidic zinc ores 660  
 Lead 5, 18  
   alloys 620, 627  
   anode 872  
   anode slime 853, 1229  
   as a condensing liquid 651  
   batteries 618  
   compounds 628  
   cupellation 1217  
   emissions 624  
   from scrap 615  
   in blood 625  
   in teeth 626  
   in urine 626  
   isotopes 582  
   minerals 584  
   ore reserves 584  
   pigments 635  
   poisoning 626, 634  
   powder 635  
   salts 628, 632  
   smelter flue dust 808  
   softening 607  
   statistics 621  
 Lead acetates 628  
 Lead alkyls 154  
 Lead arsenate 813, 820  
 Lead bisilicate 632  
 Lead blast furnace 591  
 Lead bromide 630  
 Lead bullion 594, 598, 1235  
   refining 603  
 Lead carbonate 629  
 Lead chloride 630  
 Lead chromate 1791  
 Lead cyanamide 635  
 Lead debismuthizing 2252  
 Lead Development Association 618  
 Lead fluoride 630  
 Lead fluosilicate 614  
 Lead furnace slags 645  
 Lead glass 619  
 Lead halides 630  
 Lead iodide 630  
 Lead monosilicate 632  
 Lead oxides 630, 631, 632, 1227  
 Lead silicates 632  
 Lead silicochromate 1806  
 Lead sulfates 632  
 Lead tetraacetate 629  
 Lead tin telluride 1579  
 Lead vanadates 1473  
 Lead Zinc Study Group 618  
 Lead-antimony anodes 527  
 Lead-bearing dust 624  
 Lead-copper matte 807  
 Lead-sodium alloy 2059  
 Lead-tin coatings 359  
 Leather industry 1772  
 Leavening agent 2203  
 Lechâtelierite 1910  
 Lechâtelierites 1911  
 Ledeburite 145  
 Ledge 1047  
 Leonardite 1030  
 Leonite 1030, 2145, 2161, 2194  
 Lepidocrocite 153, 163, 171, 1830  
 Lepidocrocite structure 175  
 Lepidolite 687, 2033, 2034, 2036, 2039, 2212  
 Les Baux 1044, 1068  
 Leucoxene 474, 1134, 1136, 1444  
 Lewatit M 500 1199  
 Liberation curves of sylvinitic ores 2150  
 Light metals 3, 6, 13  
 Lighter flints 1751  
 Lighting industries 1346, 1374  
 Lignites 200, 203  
 Lignitic coal 199  
 Lignosulfonates 216  
 Lime 288, 2252  
 Lime fusion of zircon 1437  
 Lime kilns 2264  
 Lime slaking 2109  
 Lime/soda sinter process 1092  
 Limestone 13, 54, 2252  
 Limestone calcination 2109  
 Limonite 33, 34

- Lindgrenite 1363  
 Linnærite 928  
 Linz-Donawitz converter 303  
 Lipowitz's alloy 875  
 Liptinite 193, 195  
 Liptinite macerals 194  
 Liquefaction 604, 703, 826, 1217  
 Liquefaction of coal 210  
 Liquid crystal 1539  
 Liquid-liquid extraction, see *Solvent extraction*  
 Liquid-phase chlorination 1892  
 Litharge 1227  
 Lithiophilite 2033  
 Lithiophorite 2034  
 Lithium 2029  
   alloys 2041, 2043  
   batteries 948  
   compounds 2049  
   isotopes 2042  
 Lithium acetate 2044  
 Lithium aluminate 2036  
 Lithium aluminum hydride 1113  
 Lithium amide 2044  
 Lithium azide 2048  
 Lithium benzoate 2044  
 Lithium borates 2016, 2017, 2020  
 Lithium bromide 2044  
 Lithium carbonate 2035, 2037, 2040, 2044, 2049, 2126  
 Lithium chloride 989, 2041, 2045, 2049  
 Lithium chromate 2046  
 Lithium citrate 2044  
 Lithium double oxides 2048  
 Lithium fluoride 1047, 2046  
 Lithium fluoroborate 1997  
 Lithium hydride 2042, 2046  
 Lithium hydroxide 2047, 2049  
 Lithium hypochlorite 2046  
 Lithium iodide 2047  
 Lithium niobate 1424, 2048  
 Lithium nitrate 2047  
 Lithium nitride 2048  
 Lithium oxide 2045, 2048  
 Lithium perchlorate 2046  
 Lithium peroxide 2048  
 Lithium phosphates 2033, 2048  
 Lithium sodium phosphate 2040  
 Lithium sulfate 2038, 2048  
 Lithium tantalate 1424, 2048  
 Lithium tetraborate 2048  
 Lithium tetrafluoroborate 2046  
 Lithography 149, 1110  
 Lithopone 667, 670, 672  
 Livingstonite 825  
 LIX 26 1536  
 LIX 87 QN 766  
 LIX TN 1911 1296  
 Lixivants 526  
 Local scrap 21  
 Lockalloy 971  
 Locron 1116  
 Lodestone 31  
 Loewite 1030, 2122  
 Logarithmic law 15  
 Löllingite 797, 798, 815  
 Loparite 1698  
 Lorandite 1544  
 Lorentz forces 1052  
 Low-carbon ferrochromium 438, 445  
 Low-carbon ferromanganese 436  
 Löweite 2145  
 Low-grade tin concentrates 692  
 Low-melting alloys 709  
 Lubrication 1386  
 Ludox 1947  
 Lump quartz 1917  
 Lump vein quartz 1920  
 Luppen 758  
 Lurgi-Darvo traveling grate pelletizing process 45  
 Lurgi-Ruhr gas process 251  
 Lutecium 12  
 Luzonite 798  
 Lydit 1912
- ## M
- Macerals 192, 200  
 Macrinite 195  
 Macrocrystalline magnesite 1014  
 Macrosegregation 321  
 MagCan process 984, 985  
 Maghemite 33, 172  
 Magnesia 1013  
 Magnesia bricks 1023  
 Magnesia chlorination 984  
 Magnesia graphite bricks 1028  
*Magnesia negra* 1813  
 Magnesia process 2202  
 Magnesia-carbon 101  
 Magnesiocromite 1764  
 Magnesioferrite 1015, 1016, 1764  
 Magnesiowüstite 1026  
 Magnesite 13, 983, 1003, 1013, 1014, 1026  
   beneficiation 1014  
   chlorination 984  
   flotation 1015  
   concentrates 1021  
 Magnesium 7, 13, 981  
   batteries 1000  
   compounds 1003

- from seawater 1005  
salts 1002
- Magnesium aluminum silicates 1028
- Magnesium ammonium phosphate 1024
- Magnesium borates 2010
- Magnesium bromide 1007
- Magnesium carbonate 1003, 1014, 2092
- Magnesium chloride 1002, 1003, 1004, 1030, 1144  
dehydration 984  
electrolysis 983  
hydrates 1009  
purification 1010  
pyrohydrolysis 1018
- Magnesium fluoride 1047
- Magnesium hydride 1000
- Magnesium hydroxide 1002, 1013, 1014, 1021, 1025, 2090
- Magnesium hydroxide separation 1016
- Magnesium nitrate 1002
- Magnesium oxide 1003, 1013
- Magnesium oxide electrolysis 983
- Magnesium oxychlorides 1004, 1030
- Magnesium oxysulfates 1030
- Magnesium phosphate 1030
- Magnesium pyroarsenate(V) 812
- Magnesium silicates 1003, 1027
- Magnesium stearate 1030
- Magnesium sulfate 1002, 1007, 1029
- Magnesium sulfate in sugar industry 1033
- Magnesium sulfate-ammine hydrates 1030
- Magnesium sulfite 1030
- Magnesium sulfonates 1025
- Magnesium-based alloys 1000
- Magnesium-zirconium reguli 1444
- Magnetherm process 993, 995
- Magnetic alloys 936
- Magnetic concentration 40
- Magnetic cores for electronic components 157
- Magnetic disturbances in Al cell 1052
- Magnetic iron oxides 164
- Magnetic minerals 1138
- Magnetic moments 374, 1703
- Magnetic pigments 153, 185
- Magnetic properties of iron 374
- Magnetic recording materials 173
- Magnetic separation 723, 1016
- Magnetite 33, 34, 148, 162, 166, 172, 802, 1069, 1472
- Magnetite anodes 1198
- Magnetite formation 518
- Magnetization curve 374
- Magnetizing roasting 40
- Magnetorestrictive behavior of cobalt 927
- Magnets 6
- Magnox alloys 1000
- Malachite 498
- Malleable cast iron 2, 146
- Malleable iron 146, 342
- Manganese 12
- Manganese acetate 1846
- Manganese(III) acetylacetonate 1856
- Manganese alum 1106
- Manganese borate 1846, 2020
- Manganese(II) carbonate 1846
- Manganese(II) chloride 1846
- Manganese ethylenebis(dithiocarbamate) 1856
- Manganese(III) fluoride 1856
- Manganese hypophosphite 1856
- Manganese(II) nitrate 1847
- Manganese nodules 1828
- Manganese oxide minerals 928
- Manganese(II) oxide 1844
- Manganese(II, III) oxide 1845
- Manganese(III) oxide 1845
- Manganese(IV) oxide 12, 1838
- Manganese(II) phosphates 1847
- Manganese(II) sulfate 1847
- Manganese sulfide 478
- Manganese telluride 1577
- Manganese tungstate 1333
- Manganites 1815, 1839
- Manhattan Project 1711
- Mannheim process 2128, 2191
- Manox Iron Blue 191
- Mansfeld copper schists 1491
- Manufacture of  $\alpha$ -FeOOH 175
- Marble 2254
- Marcasite 33
- Marignac process 1425
- Marine nodules 928
- Marine placers 687
- Marl 2254
- Marsh test 840
- Martensite 144, 147
- Mass transfer coefficients 299
- Massive iron-ore deposits 35
- Matt blue 944
- Matte 505, 594, 732
- Matte from laterites 770
- Matthiessen rule 375
- Mazarine blue 944
- McCabe-Thiele method 1714
- Mechanical and thermomechanical plating 1255
- Mechanical flotation cell 2177
- Mechanical properties of copper 494
- Mecklenburg method 1142
- Medical implants 1412
- Medium-carbon ferrochromium 438, 444
- Medium-carbon ferromanganese 434

- Megon process 1724
- Melanophlogite 1904, 1909, 1970
- Melting point of binary alumina slags 409
- Membrane cell caustic evaporation 2098
- Mendozite 1108
- 2-Mercapto-N-(2-naphthyl)acetamide 1305
- Mercury 6, 891  
alloys 908  
batteries 895  
cathode 908, 2066  
condensation 898  
density 892  
distillation 906  
emissions: 904  
fluorescent tubes 895  
in food 902  
in fungi 902  
in soil 901  
in the environment 901  
lamps 6  
methylation 915  
production 916  
purification 906  
toxicity 917  
vapor pressure 892  
viscosity 892
- Mercury(II) acetate 913
- Mercury(II) amidochloride 914
- Mercury(II) bromide 912
- Mercury(I) chloride 904, 907, 911, 918
- Mercury(II) chloride 904, 907, 912
- Mercury(I) cyanide 913
- Mercury(II) fluoride 911
- Mercury(II) iodide 913
- Mercury(I) nitrate 913
- Mercury(II) nitrate 914
- Mercury oxide 907
- Mercury(II) oxide 910
- Mercury oxycyanide 918
- Mercury selenide 1563
- Mercury(I) sulfate 914
- Mercury(II) sulfate 914
- Mercury(II) sulfide 911
- Mercury(I) thiocyanate 913
- Mercury(II) thiocyanate 913
- Mercury-containing antimony ores 833
- Mercury-rich mushrooms 902
- Mercury-selenium residue 898
- Merensky Reef 1271
- Merwinite 1015
- Metacinnabarite 893, 911
- Metal carbonyls 752
- Metal forming 344
- Metal hydrides 1897
- Metal production 15
- Metallex process 1671
- Metallic arsenic 804
- Metallic iron pigments 187
- Metalloenzymes 1376
- Metallothermic processes 480, 983, 993, 999, 1464, 1726
- Metallurgical alumina 1094
- Metallurgical cokes 225
- Metallurgical manganese ores 1817
- Metallurgical silicon 1863
- Metallurgical-grade silicon 1923
- Metal-producing associations 19
- Metal-producing cartels 19
- Metal-slag reactions 294
- Metastannic acid 711
- Metatitanates 1172
- Meteoric iron 31, 274
- Methane 241
- Methanol 1008
- Methionine 2126
- Methyl acetate 149
- Methyl isobutyl ketone 1406, 1418, 1423, 1462
- Methyl isobutyl ketone extraction 1437
- Methylation of mercury 915
- Methylchlorosilanes 1891
- Methylcyclopentadienylmanganese tricarbonyl 1856
- Methylisobutylcarbinol 1366
- Methylmercury 919
- Methylmercury(II) chloride 915
- Methyltrioxorhenium 1499
- Meyerhofferite 1987
- Miargyrite 1221
- Micaceous hematite 33
- Microcrystalline quartz species 1907
- Microcrystalline silver powder 1249
- Microelectronics 1255, 1256
- Microfine TiO<sub>2</sub> 1159
- Microlite 1404, 1419
- Microscopic characterization of coal 234
- Microwave resonators 1424
- Midrex process 112, 288
- Milk of lime 2254
- Milk of magnesia 1002
- Mill scale 52
- Miller process 1195, 1197, 1198
- Millerite 719
- Millons reagent 913
- Milori blue 179, 191
- Minamata disease 919
- Mineral matter content of coal 219
- Mineral oils 1473
- Mineral reserves 1224
- Mineral resources 1224
- Mining of potash 2147



Mintek cell 1194  
 Minting silver coins 1251  
 Mirabilite 2059, 2122, 2127, 2145  
 Mischmetal 1743, 1748  
 Mitsubishi process 519, 521  
 Mixer-settler 1719  
 Moa process 767  
 Möbius electrolysis 1241  
 Modulators 1409  
 Moganite 1904, 1908  
 Mohr's salt 147, 149  
 Moisture indicator 941  
 Molar heat capacity of iron 373  
 Molecular sieves 1258  
 Molten borates electrolysis 1990  
 Molten salt  
 distillation 1461  
 electrolysis 1461  
 electrolytic cell 2061  
 Molybdates 1382  
 Molybdenite 10, 24, 1361, 1363, 1491, 1492  
 Molybdenum 9, 1361, 1589  
 aqueous chemistry 1377  
 by powder metallurgy 1372  
 catalysts 1384  
 concentrates 478  
 metal powder 1371  
 toxicity 1376  
 Molybdenum blues 1379  
 Molybdenum carbide 478  
 Molybdenum(II) chloride 1381  
 Molybdenum dioxide 1371, 1379  
 Molybdenum disulfide 1376, 1379, 1380  
 Molybdenum hexacarbonyl 1383, 1384  
 Molybdenum hexafluoride 1376, 1381  
 Molybdenum oxide 412, 479  
 Molybdenum oxide bronzes 1379  
 Molybdenum pentachloride 1376, 1381, 1383  
 Molybdenum red, see *Molybdenum dioxide*  
 Molybdenum selenide 1379  
 Molybdenum sesquisulfide 1380  
 Molybdenum telluride 1379  
 Molybdenum trioxide 478, 1378  
 Molybdenum trisulfide 1370, 1380  
 Molybdenum-containing catalysts 1369  
 Molybdophosphoric acid 1379  
 Molycorp process 1723  
 Monazite 1607, 1655, 1697, 1707, 1744  
 Monocalcium cyanamide 2318  
 Monocrystalline silicon 1880  
 Monodisperse silica sols 1944  
 Monogal 355  
 Monohalide distillation 1053  
 Monosilane 1884, 1886  
 Monovalent aluminum 1042  
 Monovalent mercury 910  
 Montebrasite 2033  
 Monticellite 1015, 1027  
 Montmorillonite 45  
 Montroseite 1472, 1475  
 MOR process 435  
 Mordant in dyeing 1105  
 Mordants 546  
 Mortars 2275  
 Mosaic gold 711  
 Mottramite 1472  
 Müller-Kühne process 2307  
 Mullite 103  
 Multicrystalline silicon 1881  
 Multilayer capacitors 1312  
 Multiple-hearth furnace 504, 725, 896, 1367  
 Muskovite 34

**N**  
 NaK alloy 12, 2157  
 Nalcoag 1947  
 $\beta$ -Naphthol 704  
 Naphthol 2126  
 National Lead Industries process 987, 1008  
 Native  
 antimony 825  
 arsenic 796, 797  
 bismuth 846  
 copper 498  
 iron 31, 274  
 silver 1221  
 tellurium 1572  
 tin 686  
*Natrium* 2054  
 Natron 2106  
 Natural iron oxide pigments 172  
 Natural manganese dioxide 1838  
 Naumannite 1559  
 Needle-shaped  $\gamma$ -Fe<sub>2</sub>O<sub>3</sub> 178, 186  
 Neodymium 12, 1749  
 Nepheline decomposition 2202  
 Nephelines 1092, 2116, 2212  
 Neptunium 11  
 Nesquehonite 1003, 1030  
 Neurological effects 625  
 Neutral leaching 653  
 Neutralization of ammonium alum 1097  
 Neutrino 1587  
 Neutron 1587  
 absorbers 1645  
 absorption 1700  
 capture 1736  
 monochromators 968  
 New Caledonian ores 454

New Jersey process 649  
 Niccolite 716, 719, 797, 815  
 Nichrome 5  
 Nickel 4, 18, 715, 1370  
 alloys 775  
 catalysts 772, 775  
 coinage 773  
 commercial forms 771  
 complexes 780  
 consumption 772  
 electroplating 775  
 electrorefining 746  
 electrowinning 741, 743, 750  
 laterite ores 759  
 laterite process 760, 765, 770  
 matte anodes 747  
 matte from oxide ores 762  
 smelting 732  
 Nickel(II) acetate 782  
 Nickel(II) acetylacetonate 782  
 Nickel(II) amidosulfate 775  
 Nickel(II) ammonium sulfate 775  
 Nickel arsenide 716  
 Nickel boron 469  
 Nickel carbonate 748  
 Nickel(II) carbonate 775  
 Nickel carbonyl 160  
 Nickel copper sulfide matte 724  
 Nickel Development Institute 19, 773  
 Nickel dichloride 777  
 Nickel(II) dimethylglyoximate 782  
 Nickel(II) formate 782  
 Nickel(II) halides 777  
 Nickel(II) hydroxide 777  
 electrolytic oxidation 741  
 Nickel(III) hydroxide 741, 748  
 Nickel(II) nitrate 778  
 Nickel(II) oxalate 782  
 Nickel oxide 737  
 Nickel(II) oxide 778  
 Nickel rutile yellow 1155  
 Nickel sulfamate 775  
 Nickel(II) sulfate 779  
 Nickel sulfides 779  
 roasting 736  
 smelting 726  
 Nickel tetracarbonyl 718, 752, 780  
 Nickel(II) tetrafluoroborate 780  
 Nickel-cadmium batteries 775, 873, 874  
 Nickel-chromium master alloys 448  
 Nickel-cobalt alloys 947  
 Nickel-containing manganese nodules 718  
 Nickel-copper matte 734  
 Nickel-copper-cobalt alloy 933  
 Nickeliferous limonite 719, 758  
 Nickeliferous pyrrhotite 719  
 Nickel-niobium 472  
 Nickel-steel armor plate 716  
 Nicotine sulfide 704  
 Niobium 9, 1403  
 Niobium alkoxides 1408  
 Niobium borides 1410  
 Niobium carbides 1410  
 Niobium consumption 1414  
 Niobium hydrides 1411  
 Niobium nitrides 1410  
 Niobium oxide production 1405  
 Niobium oxychloride 1409  
 Niobium pentachloride 1407, 1409  
 reduction 1411  
 Niobium pentafluoride 1409  
 Niobium pentoxide 1408  
 optical-grade 1409  
 reduction 1411  
 Niobium silicides 1410  
 Niobium tetrachloride 1409  
 Nippon Steel process 112  
 Nippon Yakin Oheyama process 758  
 NiS/CoS precipitation 739  
 Nitrate reductase 1376  
 Nitric acid pickling solutions 169  
 Nitride formers 409  
 Nitrides 996  
 Nitriding 371  
 Nitridoactinorodiodiaquodiruthenate(IV) 1313  
 Nitrobenzene 177  
 3-Nitrobenzenesulfonic acid 1187  
 4-Nitrobenzoic acid 1187  
 Nitrogen oxides 998  
 Nitrogenase 1376  
 Nitrogen-containing low-carbon ferrochromium 448  
 Nitrogen-free operation of blast furnace 62  
 $\alpha$ -Nitroso- $\beta$ -naphthol 657  
 NKK process 130  
 Nodular chert 1912  
 Nodular iron 1000  
 Nodularization 1000  
 Noise reduction 136  
 Non-bronze blue 179  
 Noncrystalline silica minerals 1910, 1911  
 Nonferrous metals 3  
 Noranda process 521, 522  
 Nordstrandite 1063, 1064  
 Norsk Hydro cell 991  
 Norsk Hydro process 986  
 Norsk Hydro refining furnace 997  
 Novaculite 1912  
 Nozzle process 1630  
 Nuclear fission 1600

Nuclear reactor 11  
 Nuclear safety 1644  
 Nuclear technology 1308, 1374  
 Nucleation 50, 1081  
 Nutritional additives 546  
 Nyacol 1947

**O**

Occidental pyrolysis process 255  
 Octacarbonyldicobalt 939  
 Odda process 2331  
 Oil residues 1479  
 Oil shales 1607  
 Oklo mine 1600  
*Old Nick* 716  
 Oleic acid 40  
 Oligodynamic effect 1264  
 Olivine 983  
 Onor 1806  
 Oolitic ironstone 33  
 Opal-A 1910  
 Opal-A<sub>N</sub> 1911  
 Opal-C 1911  
 Opal-CT 1911  
 Opals-A<sub>G</sub> 1911  
 Open-hearth furnace 1022  
 Optical fibers 1892  
 Optical materials 1514  
 Optical modulators 1424  
 Optical switches 1424  
 Optical texture of coal 238  
 Optical windows 1028  
 Optical-grade niobium pentoxide 1409  
 Orange iron oxide 175  
 Orangite 1655  
 Ore beneficiation 2120  
 Ore digestion 2120  
 Orford process 735  
 Organic binders 216  
 Organic components of coal 192, 200  
 Organic matter in bauxite 1085  
 Organic mercury compounds 919  
 Organic mercury derivatives 915  
 Organic precipitation agents 1289  
 Organic sulfur 219  
 Organolead compounds 633  
 Organolithium compounds 2042  
 Organomagnesium compounds 1003  
 Organophosphoric acids 1718  
 Organosilanes 2229  
 Organotin compounds 711, 2068  
 Origin of copper ores 498  
 Orpiment 795, 797, 813

Orthoclase 34  
 Orthoquartzite 1912  
 Orthotitanates 1172  
 Oscillator quartz 1914  
 Oscillators 1424  
 Osemund iron 276  
 Oslo crystallizer 2173  
 Oslo evaporator 2091  
 Osmiridium 1276  
 Osmium 1280  
 Osmium compounds 1304  
 Osmium(VIII) oxide 1304, 1310, 1320  
 Osmium tetroxide 1300  
 Otavite 870  
 Outokumpu 597  
   ferrochromium process 443  
   flash smelting 514  
   process 599  
 Overvoltage 1050  
 Oxalic acid 1195  
 Oxidation  
   of aluminum 1042  
   of As<sub>2</sub>O<sub>3</sub> 811  
   of carbon steels 368  
   of Co<sup>2+</sup> 937  
   of ethylene 1258  
   of ferrous ion 165  
   of iron 368  
   of iron pentacarbonyl 158  
   of low-alloy steels 368  
   of tetrachlorosilane 1897  
   of TiCl<sub>4</sub> 1145  
 Oxidation catalyst 1257  
 Oxidation potential Ti<sup>3+</sup>/Ti<sup>4+</sup> 1169  
 Oxidation-resistant coatings 1374  
 Oxo synthesis 1310  
 Oxomolybdenum cations 1376  
 Oxomolybdenum halides 1382  
 Oxygen enrichment 62  
 Oxygen flash smelting 734  
 Oxygen in coal 205  
 Oxygen potentials of oxides 462  
 Oxygen sprinkle smelting 512  
 Oxygen-blowing processes 302  
 Oxygen-blown converter 445  
 Oxygen-free copper 540  
 Oxygen-releasing compounds 472  
 Oxyhydration 1385  
 Oxystearic acid 1031

**P**

Pachuca tank 1225  
*Pai thung* 716  
 Paint driers 6  
 Paints 1772

Palladium 1280  
   ammine complexes 1303  
   compounds 1303  
   purification 1297  
 Palladium(II) chloride 1254, 1303, 1310  
 Palladium(II) diamminedinitrite 1313  
 Palladium oxides 1303  
 Palladium-base alloys 1315  
 Pandermite 466, 1987  
 Paper industry 1096, 1105, 1110  
 Parabolic law 368  
 Paris blue 179  
 Parkes desilvering 604, 856, 1188, 1217, 1227  
 Partial roasting 504  
 Partially stabilized zirconias 1446  
 Particulate magnesium 998  
 Pascoite 1475  
 Passivation 365  
 Passivation of iron 1805  
 Patera process 1225  
 Paterite 1363  
 Patio process 1225  
 Patronite 1472  
 Pattinson process 1217, 1226  
 Pearlite 145  
 Peat 195, 200, 203  
 Pedersen process 1092  
 Peirce-Smith converters 519, 520, 730, 762  
 Pelletizing 41, 44  
 Pelletizing of UO<sub>2</sub> 1635  
 Pellets 44  
 Pen nibs 1207  
 Penarroya-Leferrer vacuum distillation 613  
 Peniakoff process 2131  
 Penniman process 173, 175  
 Pentaborane 1999, 2000, 2002  
 Pentamine cobalt process 740  
 Pentlandite 32, 719, 928, 1277  
 Peptization of gels 1943  
 Perborate anion 2015  
 Perchloric acid 1287  
 Percolation leaching 526  
 Perenox 572  
 Periclase 1013, 1022, 1026  
 Peridur 45  
 Periodic table 1  
 Permalloys 5  
 Permanent magnetic materials 377, 1752  
 Perovskite 474, 1134, 1136, 1172  
 Peroxide ion 164  
 Peroxy group 1173  
 Peroxyacid 1173  
 Peroxytitanates 1173  
 Peroxytitanic acid 1173

Peroxytitanyl ions 1173  
 Perrhenates 1493, 1496  
 Perrhenic acid 1496, 1499  
 Pesticides 215  
 Petalite 2033, 2036, 2049  
 Petrographic studies of coal 204  
 Petroleum catalysts 1369  
 Petroleum coke 1045  
 Petzite 1221  
 Pharmaceutical preparations 1096  
 Phenakite 961  
 Phenanthrene 1057  
 Phenol 704  
 Phenylmercury 919  
 Phonolite 1070  
 Phosgenite 584  
 Phosphate fertilizers 1460  
 Phosphate rock 12, 13, 460, 1524, 1607, 1613  
   uranium from 23  
 Phosphates 1473  
 Phosphatizing 144  
 Phosphinal 1121  
 Phosphine 419, 668  
 Phosphinox 678  
 Phosphogypsum 2290  
 Phosphomolybdates 1383, 1384  
 Phosphonic acids 1718  
 Phosphor 1539  
 Phosphorodithioates 1383  
 Phosphors 1514, 1735  
 Phosphorus-containing extractants 1717  
 Photochromic glasses 1258  
 Photodetectors 1539  
 Photoelectric cells 10  
 Photographic printing paper 1223  
 Photographic sensitizer 1202  
 Photographic slimes 1223  
 Photography 8, 1258  
 Photolithography 1311  
 Phototropic glasses 1754  
 Phtanite 1912  
 Phyllites 1070  
 Phyllosilicates 1014  
 Pickling 149, 166, 175, 344, 349  
   of stainless steel 169  
   of titanium 1168  
 Picromerite 1030  
 Pig iron 1, 54, 137, 146  
   import and export 141  
   production 139  
 Pigment Blue 950  
 Pigments 4, 6  
 Pilbarite 1655  
 Pirotpaulite 1544

Pirssonite 2106  
 Pitch 216  
 Pitchblende 1606  
 Pitting corrosion 366  
 Plagioclase 34  
 Plasma arc remelting 338  
 Plasma furnaces 438  
 Plasma processes 415, 1631, 1962  
 Plasma spraying 1374  
 Plasmamelt 124  
 Platina 1270  
 Plating baths 941  
 Platinized titanium anodes 1198  
 Platinum 8, 1280  
 allergy 1319  
 coatings 1314  
 coins 1271  
 Platinum acetylacetonate 1314  
 Platinum chlorides 1302  
 Platinum(II) diamminedinitrite 1313  
 Platinum group metals  
 analysis 1305  
 from sulfide ores 1282  
 separation 1287  
 Platinum metal blacks 1309  
 Platinum oxide catalysts 1321  
 Platinum oxides 1302  
 Platinum rhodium gauze catalysts 1278  
 Platinum-arsenic alloy 1270  
 Platinum-group metals 1196  
 Platinum-iridium alloys 1312  
 Platinum-rhenium catalysts 1492  
 Platinum-rhodium gauzes 1309  
 Plattner process 1187  
 Plumbum 582  
 Plumbum cinerum 845  
 Plutonium 11, 1685  
 Plutonium isotopes 1685  
 Plutonium-carbon system 1689  
 Pneumatic coarse-grain flotation cell 2178  
 Pneumatic free-jet flotation 2177  
 Poling 529  
 Polishing compounds 1753  
 Pollucite 2211, 2216  
 Polonides 1592  
 Polonium 10, 1585, 1591  
 Polonium monoxide 1592  
 Poly(aluminum chloride) 1116  
 Poly(aluminum hydroxychlorides) 1114  
 Poly(phenylene sulfide) 2230  
 Polyalcohol 470, 671  
 Polyarsenides 815  
 Polybasite 1221  
 Polycarboxylic acids 1711

Polychlorinated biphenyls 999  
 Polychloropolysilanes 1892  
 Polydymite 719  
 Polygermenes 1516  
 Polyhalite 1030, 2090, 2145, 2175, 2286  
 Polyhalogenated diphenyl ether 1025  
 Polymeric borate anions 2011  
 Polymerization 2157  
 Polymerization catalysts 945, 1033, 1113  
 Polynuclear cobaltamines 938  
 Polysulfide ion 1117  
 Polysulfides 2222  
 Poly titanates 1172  
 Polytungstates 1351  
 Polyxene 1276  
 Potassium continuous production 2155  
 Porcelain 663  
 Porcellanite 1912  
 Pore-size distribution of a silica gel 1951  
 Porosil framework structures 1968  
 Porosils 1967, 1969  
 Porphyry copper ores 10, 24, 1492  
 Porter column 1615  
 Portland cement 1033, 1090, 2202  
 Portlandite 1915  
 Positron 1586  
 Pot room working conditions 1094  
 Potash 2142, 2143  
 deposits 2146  
 fertilizers 2174  
 mining 2147  
 ore flotation 2179  
 ore treatment 2149  
 Potash Research Institute 2160  
 Potash-magnesia 2152  
 Potassium  
 isotopes 12  
 radioactive isotope  $^{40}\text{K}$  2184  
 sulfate from kainite 2195  
 sulfate from KCl and gypsum 2196  
 sulfate from KCl and  $\text{MgSO}_4$  2193  
 sulfate from KCl and  $\text{Na}_2\text{SO}_4$  2195  
 sulfate from langbeinite 2195  
 Potassium alkoxides 2158  
 Potassium alum 1102, 1106  
 Potassium aluminum sulfate 1106  
 Potassium 3-aminopropylamide 2158  
 Potassium amyl xanthate 1366  
 Potassium antimonate 839  
 Potassium arsenate(V) 812  
 Potassium bases 2158  
 Potassium benzoate 2204  
 Potassium borates 2020  
 Potassium carbonate 12, 2199  
 Potassium carbonate hydrate 2202

Potassium chlorate 180  
 Potassium chloride 1031, 2077, 2142, 2148, 2154, 2159, 2187  
 electrolysis 2198  
 flotation 2176  
 Potassium chromate 1789  
 Potassium chromium(III) sulfate 1785  
 Potassium content of  $\text{Al}_2\text{O}_3$  1084  
 Potassium cyanamide 667  
 Potassium dichromate 895, 1789  
 Potassium dicyanoargentate(I) 1244, 1247  
 Potassium dicyanoaurate 1199, 1208  
 Potassium disulfite 2234  
 Potassium ferrate 2198  
 Potassium ferrocyanide 2092  
 Potassium fluorogermanate 1516  
 Potassium graphite 2158  
 Potassium heptafluorotantalate 1421  
 Potassium heptafluorotantalate, see *Potassium tantalum fluoride*  
 Potassium hexacyanoferrate(II) 179  
 Potassium hexafluorohafnate 1467  
 Potassium hexafluorotitanate 1165  
 Potassium hexafluorozirconate 1449  
 Potassium hexahydroxyantimonate 839  
 Potassium hexamethyldisilazane 2158  
 Potassium hexanitrorhodate(III) 1298  
 Potassium hexanitrorhodate(III) 1295  
 Potassium hydride 2158  
 Potassium hydrogencarbonate 2204  
 Potassium hydroxide 2188, 2198  
 Potassium manganate(V) 1848  
 Potassium manganate(VI) 1848  
 Potassium mercury iodide 913  
 Potassium metavanadate 1484, 1487  
 Potassium nitrite 2198  
 Potassium osmate(VI) 1304  
 Potassium pentaborate 2017  
 Potassium permanganate 1848  
 anodic oxidation 1850  
 Potassium ruthenate(VI) 1304  
 Potassium salts production 2153  
 Potassium silicate manufacture 2203  
 Potassium sulfate 2152, 2154, 2190  
 solubility 2191  
 Potassium sulfide 1173  
 Potassium superoxide 2159  
 Potassium tantalum fluoride 1424  
 Potassium tetraborate 2017  
 Potassium tetrachloroplatinate(II) 1302  
 Potassium tetraniroplatinate(II) 1302, 1313  
 Potassium titanate 1173  
 Potassium trialkylborohydrides 2159  
 Potassium tri-*iso*-propoxyborohydride 2159

Potassium tri-*sec*-amylborohydride 2159  
 Potassium tri-*sec*-butylborohydride 2159  
 Potassium-hafnium carbonate 1460  
 Potassium-sodium alloys 2157  
 Pourbaix diagram for copper 496  
 Powder metallurgy 1167, 1342, 1372  
 Powellite 1333, 1363, 1371  
 Praseodymium 12, 1749  
 Prebaked anodes 1046  
 Precious metals 3, 8  
 Precipitated silicas 1962, 1964, 1966  
 Precipitation  
 by reducing gases 528  
 kinetics 1081  
 of arsenic 808  
 of iron hydroxide 653  
 of magnesium hydroxide 1016  
 of sodium bicarbonate 2111  
 of sylvinit 2169  
 with hydrogen sulfide 769  
 Precipitation deoxidation 297  
 Precision casting 1028  
 Preoxidation 230  
 Presses 385  
 Pressure carbonyl refining process 755  
 Pressure electro-slag remelting 338  
 Pressure leaching 526  
 Pressure leaching of sulfidic zinc concentrates 660  
 Pressure operation of blast furnace 62  
 Prestaminol 1031  
 Pretreatment of used steel products 386  
 Prevention of water pollution 136  
 Priceite 466, 1987  
 Prices of metals 18  
 Primary amines 1718  
 Printing alloys 5  
 Printing industry 1772  
 Printing ink industry 182  
 Printing inks 1154  
 Probertite 1987, 2016  
 Processing  
 of bauxites 1479  
 of copper matte 1237  
 of photographic materials for silver 1237  
 of titanium sponge 1166  
 Production  
 of  $^{233}\text{U}$  1675  
 of  $\alpha\text{-Fe}_2\text{O}_3$  platelets 177  
 of anthraquinone 1113  
 of benzyl chloride 665  
 of butyl rubber 1113  
 of ferromanganese in blast furnaces 423  
 of hafnium 1461  
 of iron oxide pigments 173  
 of lead bullion 1226  
 of mercury 916

of  $MgCl_2$  from seawater or brines 1007  
 of niobium oxide 1405  
 of potassium salts 2153  
 of titanium sponge 1161  
 of  $UF_6$  1625  
 Promethium 12, 1588, 1700  
 Properties of barium ferrite 189  
 Protactinium 10, 1594  
 Proustite 797, 1221, 1225  
 Proximate analysis 202, 218, 239  
 Proximate analysis of coal 202  
 Prussian blue 148, 149, 179  
 Pseudoboehmite 1064, 1065  
 Psilomelane 1815  
 Pucherite 863  
 Puddled steel 279  
 Pure antimony trichloride 836  
 Pure iron 3, 143, 372  
 Pure molybdenum trioxide 1369  
 PUREX process 1588, 1589, 1689  
 Purgative 1002  
 Purification 1461  
 of crude brine 2090  
 of crude phosphoric acid 905  
 of iridium 1298  
 of magnesium chloride 1010  
 of mercury 906  
 of palladium 1297  
 of rhodium 1298  
 of  $TiCl_4$  1145, 1161  
 of uranium concentrate 1617  
 Purofer process 112  
 Purple of Cassius 1201  
 Putty 2254  
 Pyrrhotite 1225  
 Pyrrhotite 1221  
 Pyrite 33, 34, 148, 164, 219, 660, 928, 1069, 1084, 1277, 1364  
 Pyrite cinder 53  
 analysis 103  
 chlorination 2126  
 Pyrite films 159  
 Pyrochlore 472, 1404, 1418, 1655  
 Pyrogenic silica 1944, 1954, 1958, 1959, 1961  
 Pyrohydrolysis of magnesium chloride 1018  
 Pyrolusite 34, 1815, 1838  
 Pyrolysis  
 of carboxylates 934  
 of coal 211  
 of trichlorosilane 1889  
 Pyrometallurgical copper production 508  
 Pyrometallurgical tin refining 702  
 Pyrometallurgy of nickel concentrates 724  
 Pyromorphite 584  
 Pyrophoric properties 1733  
 Pyrophoric properties of flint alloy 1750

Pyrophoric surface layer 1442  
 Pyrophyllites 1028  
 Pyrostibite 825  
 Pyrotechnics 841, 1772  
 Pyrrhotite 33, 34, 165, 660, 722, 928

## Q

Q-S process 523  
 QSL 597  
 QSL lead smelting process 601  
 Quartz 34, 1069, 1902, 1906, 1916  
 Quartz arenite 1912  
 Quartz for optical and oscillator devices 1924  
 Quartz gravel 1917, 1921  
 Quartz powder 1917, 1921  
 Quartz raw materials 1917  
 Quartz rock 1917, 1921  
 Quartz sands 417, 1917, 1920-1925  
 Quartz sandstone 1911, 1912  
 Quartz single crystals 1912  
 Quartz whiskers 1908  
 Quartzine 1908, 1911  
 Quartzite 467, 1912  
 Quaternary ammonium salts 1718  
 Quenching 348  
 Quicklime 2258

## R

Radiation shielding 1643  
 Radioactive decay 1587, 1602  
 Radioactive metals 3, 10  
 Radioactivity 1585  
 Radiogardase-Cs 184  
 Radiolarite 1912  
 Radium 10, 13, 1585, 1593, 1745  
 Radon 10, 1593  
 Railway-track material 273  
 Rammelsbergite 719  
 Ramsdellite 1838  
 Raney cobalt 947  
 Raoult's law 690  
 Rare earth complexes 1732  
 Rare earths 3, 12, 1695  
 carbides 1731  
 chalcogenides 1731  
 double salts 1728  
 halides 1730  
 hydrides 1728  
 hydroxides 1728  
 nitrides 1731  
 oxides 1728  
 permanent magnetic materials 1733  
 peroxides 1728  
 separation 1708

Rare-earth bronze 1379  
 Raspite 1333  
 Rate of dissolution of alumina in the electrolyte 1094  
 Reaction of chlorine with scrap iron 151  
 Reactive alumina 1101  
 Realgar 795, 797, 813  
 Recovery  
 of  $Al(OH)_3$  1081  
 of alumina from clay 1093  
 of ammonia 2113  
 of gold from alloys 1197  
 Rectifiers 871, 1564  
 Recycling 385  
 of cadmium 873  
 of metals 21  
 of steel 381  
 of various materials 381  
 Red alloy 930  
 Red antimony 825  
 Red cake 1370  
 Red hematite 33  
 Red iron oxide 158, 178  
 Red lead 632, 635  
 Red mercury(II) oxide 911  
 Red mud 173, 1088, 1104  
 Red ochre 33  
 Reducing agents 12, 153, 404  
 Reducing power of potassium metal 2142  
 Reduction  
 degradation index 49  
 in electric furnace 698  
 in rotary kilns 698  
 of aromatic nitro compounds with iron 176  
 of beryllium chloride 965  
 of beryllium fluoride 965  
 of boron trioxide 1989  
 of chalcopyrite 509  
 of cobalt ions 935  
 of iron oxides 49  
 of KCl by sodium 2155  
 of manganese oxides 993, 1818  
 of niobium pentachloride 1411  
 of niobium pentoxide 1411  
 of noise 132  
 of refractory oxides 405  
 of  $ThF_4$  1672  
 of  $ThO_2$  1669  
 of  $TiCl_4$  1160  
 with magnesium 1162  
 with sodium 1162  
 of  $TiO_2$  1162  
 by Al 475  
 of titanium tetrafluoride 1164  
 of tungsten trioxide 1340  
 of  $UF_4$  1636  
 of  $UF_6$  1635  
 of vanadium oxides 476, 1480

with hydrogen under pressure 739, 742  
 Refined arsenic trioxide 803  
 Refining 18  
 by electrolysis 1185  
 of copper 529  
 of ferronickel 459  
 of lead bullion 603  
 of nickel metal anodes 746  
 of silver with nitric acid 1240  
 of silver with sulfuric acid 1241  
 of zinc 652  
 Reforming 1100, 1309, 1492, 1498  
 catalysts 1284, 1499  
 of natural gas 112  
 Refractories 7, 9, 943  
 Refractory brick in a regenerator 100  
 Refractory bricks 1022  
 Refractory fibers 1946  
 Refractory gold ores 34  
 Refractory lining 1027  
 Refractory magnesia 1003  
 Refractory materials 101, 1013, 1028  
 Refractory metals 3, 8  
 Refractory silica 1915, 1916  
 Regeneration by electrolysis 167  
 Regeneration of carbon 1194  
 Regeneration of HF-HNO<sub>3</sub> pickling liquors 170-171  
 Regeneration of iron-containing pickling baths 166  
 Regenerative evaporators 1088  
 Reichert cone 40  
 Reinforcing fillers 1959  
 Relative reducibility 49  
 Relays 1256  
 Release of hydrogen by platinum metals 1321  
 Remelting of copper cathodes 536  
 Remelting processes 336  
 Removal  
 of pyritic sulfur from coal 209  
 of vanadium oxychloride 1145  
 of vanadium tetrachloride 1145  
 Renal effects 625  
 Renierite 1507  
 Reproduction effects 625  
 Residues from zinc electrolysis 645  
 Resinite 194  
 Resistance thermometry 1311  
 Resorcinol 2126  
 Retardation process 171  
 Retort processes 114  
 Reverberatory furnace smelting 727  
 Reverberatory furnaces 510, 511  
 Reynolds number 300  
 Rheniform process 1499  
 Rhenium 9, 10, 24, 1491  
 compounds 1497

halides 1498  
 oxides 1368, 1497  
 powder 1495  
 recovery 1494  
 sulfides 1497

Rhenium carbonyl 1498  
 Rhenium(IV) fluoride 1498  
 Rhenium(V) fluoride 1498  
 Rhenium(VI) fluoride 1498  
 Rhenium(VII) fluoride 1497  
 Rhenium heptoxide 1493  
 Rhenium(VII) oxide 1496  
 Rhenium pentachloride 1498  
 Rhenium(VII) sulfide 1497

Rhodium 1280  
 alum 1106  
 chlorides 1303  
 coatings 1313  
 compounds 1303  
 purification 1298

Rhodium sulfate 1304, 1313  
 Rhodium(III) iodide 1310  
 Rhodochrosite 1815  
 Rhodonite 1815  
 Rimming steel 324  
 Rinneite 2145  
 RLE process 529  
 Roast reaction 585, 596  
 Roasting 503, 826  
 of arsenical materials 799  
 of nickel sulfide 736  
 of siderite ore 41

Rock salt 2059, 2077, 2089, 2145, 2148  
 Rocket nozzles 1346  
 Rockwell hydrolysis process 256  
 Roll cladding 1255  
 Rolled steel 281  
 Rolling 345  
 Roscoelite 1472  
 Rotary grinding 967  
 Rotary kiln processes 118  
 Rotary kiln-electric furnace process 454  
 Rotary kilns 896, 1086  
 Rubber 6  
 Rubidium 2211  
 Russel process 1218  
 Russellite 1333  
 Ruthenium 1280  
 Ruthenium(IV) chloride 1304  
 Ruthenium compounds 1304  
 Ruthenium(VIII) oxide 1304, 1310, 1320  
 Ruthner process 173  
 Rutile 103, 1069, 1134, 1136, 1137, 1444, 1656  
 Rutile pigments 1143, 1155

## S

Sachtolith 671, 672  
 Safflorite 928  
 Salinity 2086  
 Salt harvesting 2089  
 Salts of inorganic rare earth oxoacids 1728  
 Samarium 12  
 Samarskite 1419, 1698  
 Sand-lime bricks 2275  
 Sanmartinite 1333  
 Sasol 213, 214  
 Sassolite 1987  
 Scandium 10, 1695, 1698  
 Scandium alum 1106  
 Scandium separation 1722  
 Scattered metals 3, 10  
 Schairerite 1085  
 Schapbachite 1221  
 Schauerteite 1507  
 Scheele's green 811  
 Scheelite 462, 1334, 1335, 1363, 1371  
 Scheibel column 1615  
 Schists 1070  
 Schlippe's salt 840  
 Schmidt number 300  
 Schoenite 2180  
 Schönite 1007, 1008, 1030, 2145, 2154, 2161, 2194  
 Schroeckingerite 1606  
 Schweinfurth green 811  
 Scrap 283, 285, 381  
 consumption 387  
 external 21  
 local 21  
 steel 21  
 substitute 22  
 world market 387

Scrap silver 1223  
 Sea bitterns 1007  
 Sea salt 2086  
 Seahostar 1947  
 Seawater composition 1017  
 Seawater evaporation 1007, 2086  
 Seaweeds 12  
 Secondary amines 1718  
 Secondary metals 3, 5  
 Sedema process 1841  
 Seed particles 757, 1081  
 Segregation process 503, 759  
 Séjourmet process 1373  
 Selective oxidation 1385  
 Selective reduction smelting 761  
 Selenac 1566  
 Selenate alum 1106  
 Selenates 1567

Selenic acid 1567  
 Selenides 1567  
 Selenites 1566  
 Selenium 10, 1230, 1557  
 Selenium dioxide 1493, 1563, 1566  
 Selenium disulfide 1567  
 Selenium halides 1567  
 Selenium oxide 1368  
 Selenium removal 742  
 Selenium trioxide 1567  
 Selenocarbamic acid 1563  
 Selenous acid 1566  
 Selenyl chloride 1567  
 Semiautogenous grinding 39  
 Semiconductor industries 1374  
 Semiconductor memories 1207, 1312  
 Semiconductor silicon 1865  
 Semiconductors 10, 1379, 1539  
 Semifusinite 195  
 Semikilled steel 327  
 Semisplint coal 199  
 Senarmontite 825  
 Sensors 1311  
 Separation  
 of  $^{233}\text{U}$  1676  
 of bismuth from metallic lead 850  
 of cobalt from other metal ions 933  
 of europium oxide 1722  
 of gold from silver 1185  
 of platinum group metals 1287  
 of rare earths 1708  
 of scandium 1722  
 of yttrium oxide 1722  
 of zirconium 1462

Separation factor 1714  
 Serpentine 1014, 1032  
 Serpentinite 758  
 Sewage treatment 2275  
 Shaft furnace 113, 115  
 Shaft furnace processes 110  
 Shatter test 48  
 Shear steel 279  
 Shearing machines 384  
 Sherritt ammonia leach process 739  
 Sherritt Gordon process 932  
 Sherwood number 300  
 Shield against  $\gamma$ -rays 5  
 Showa Denko ferrochromium process 444  
 Shredders 385  
 Sialic lodes 644  
 Sicor 678  
 Siderite 33, 34, 35, 53, 1069, 1084  
 Siderite ore roasting 41  
 Sideritis 31  
 Sidérurgie 31

Siegenite 719, 928  
 Siemens-Martin furnace 101  
 Siemens-Martin process 31, 309  
 Siennas 172  
 Sievert square root law 292  
 Silane 1866  
 Silanediol groups 1935  
 Silanes 672, 1884  
 Silanol groups 1902, 1935  
 on silica surface 1958  
 Silex 1912  
 Silica 101, 1902  
 aquasols 1941, 1943  
 bricks 102, 1916  
 dust 1970  
 gel 1948  
 organosols 1940  
 rocks 1911, 1912  
 slate 1912  
 sols 1933, 1939  
 Silica W 1905, 1911  
 Silicate precipitation 1337  
 Silicides 1374, 1899  
 Silicoborate 2010  
 Silicochromium 446  
 Silicomanganese 432  
 Silicon 12, 1861  
 content of  $\text{Al}_2\text{O}_3$  1084  
 rectifiers 535  
 wafers 1877, 1946  
 Silicon borides 1898  
 Silicon bromides 1893  
 Silicon carbide 101, 649, 1890  
 plates 675  
 retorts 675  
 Silicon dioxide 1902  
 Silicon fluorides 1893  
 Silicon halides 1886  
 Silicon hydrides 1883  
 Silicon iodides 1894  
 Silicon monoxide 418, 1895  
 Silicon oxides 1895  
 Silicon sesquioxides 1896  
 Silicon sulfide 1897  
 Silicon tetrabromide 1894  
 Silicon tetrachloride 1462, 1889, 1955  
 Silicrete 1912  
 Sillimanite 1656  
 Siloxane 1958  
 Siloxane bridges 1935  
 Siloxanes 672  
 Silvanite 1221  
 Silver 8, 17, 1215  
 catalysts 1258  
 coins 1218, 1223, 1251

complexes 1247  
 crucibles 1257  
 demonetization 1218  
 dissolution 1220  
 drinking vessels 1264  
 electroplating 1253  
 electrorefining 1227  
 enrichment 1226  
 extraction 1217  
   from copper matte 1231  
   from electrolytic lead refining 1228  
 extraction from gold ores 1223  
 flakes 1250  
 from tin ores 1223  
 German 4, 5  
 in medicine 1252  
 plating 1253  
   by chemical reactions 1254  
 powder 1248  
   microcrystalline 1249  
   spheroidal 1250  
 preparations in medicine 1264  
 refining 1240  
 Silver(I) acetate 1246  
 Silver acetylde 1248  
 Silver albuminate 1252  
 Silver amalgam 909  
 Silver amide 1248  
 Silver azide 1247  
 Silver bromide 1244  
 Silver bronzes 1250  
 Silver carbonate 1247  
   thermal decomposition 1250  
 Silver chlorate 1246, 1264  
 Silver chloride 1225, 1244, 1252, 1260  
 Silver chromate 1791  
 Silver cyanide 1247  
 Silver dichromate 1791  
 Silver(I) fluoride 1246  
 Silver fulminate 1248, 1264  
 Silver halide 1258  
 Silver halides 1224, 1244  
 Silver iodide 1244, 1259  
 Silver isocyanate 1247  
 Silver(I) lactate 1246  
 Silver nitrate 1242, 1252, 1259  
 Silver nitrate for the photographic industry 1244  
 Silver oxalate 1248  
 Silver(I) oxide 1245, 1257  
   thermal decomposition 1250  
 Silver(II) oxide 1245, 1257  
 Silver oxides 1244, 1245  
 Silver perchlorate 1246  
 Silver permanganate 1246  
 Silver(I) propionate 1246  
 Silver rubidium iodide 2213

Silver sulfate 1246  
 Silver sulfide 1224, 1225, 1246  
   coating 1220  
 Silver tetrafluoroborate 1246  
 Silver thiocyanate 1247  
 Silver-base alloys 1315  
 Silver-based materials for electrical contacts 1256  
 Silver-coated copper wires 1257  
 Silver-containing alloys 1253  
 Silver-containing catalysts 1224  
 Silver-containing scrap 1232  
 Silver-containing tin deposits 1223  
 Silver-copper alloys 1252  
 Silver-palladium powder 1250  
 Silver-tin amalgams 1253  
 Silverware 8  
 Silylene 1886  
 Simic deposits 644  
 Single crystals 1551  
 Single-crystal growth 1868  
 Single-crystal magnesium 997  
 Single-crystal silicon 1868  
 Single-phase submerged arc furnace 480  
 Sinter 44  
 Sinter plant 134  
 Sinter roasting 646  
 Sintered magnesia 1012, 1021, 1022  
 Sintering 41, 47, 1342  
 Sintering metallurgy of bronzes 709  
 Sintering of dolomite 1019  
 Sintering plants 133  
 Siros melt lance 600  
 Siros melt process 521  
 Skin-pass rolling 348  
 Skutterudite 928  
 SL/RN process 119, 288  
 Slag 54, 505  
   Thomas 280  
 Slag decopperizing 521  
 Slag fuming 648  
 Slag notch 59  
 Slag-free ferrosilicon production 418  
 Slag-fuming process 595  
 Slaked lime 2254, 2271  
 Slot ovens 251  
 Smaltite 797, 815, 928  
 Smelting  
   in a rotary kiln 675  
   of arsenical ores 797  
   of nickel sulfide 726  
 Smelting-reduction processes 123, 125  
 Smithsonite 641, 644, 660  
 Snowtex 1947  
 Soda ash, see *Sodium carbonate*

Sodalite 1119  
 Söderberg anodes 1046, 1047  
 Sodium 18, 2053  
 Sodium acetylde 2058  
 Sodium alkoxides 2068  
 Sodium alum 1108  
 Sodium aluminate 1068, 1072, 1097, 1109  
 Sodium aluminum silicate 2039  
 Sodium aluminum sulfate 1108  
 Sodium amalgams 909, 2069, 2241  
 Sodium amide 2068  
 Sodium ammonium vanadate 1484  
 Sodium amyl xanthate 722  
 Sodium antimonate 612  
 Sodium arsenate(III) 811  
 Sodium arsenate(V) 812  
 Sodium azide 2057, 2068  
 Sodium bicarbonate precipitation 2111  
 Sodium borate ore 2014  
 Sodium borates 2012, 2020  
 Sodium borohydride 1301, 2067, 2241  
 Sodium calcium borate ores 2014  
 Sodium carbonate 12, 2067, 2104  
 Sodium carbonate hydrates 2105  
 Sodium carbonate-containing minerals 2114  
 Sodium chloride 2059, 2073  
   crystallization 2087  
   electrolysis 2096  
   solubility 2075  
 Sodium chromate 1788  
 Sodium content of alumina 1084  
 Sodium cyanide 1190  
 Sodium dichromate 1773, 1788, 2126  
 Sodium disulfide 2223, 2227  
 Sodium disulfite 2234  
 Sodium disulfatoaurate(I) 1201  
 Sodium dithionite 2239  
 Sodium dithiosulfatoaurate(I) 1202  
 Sodium fluoride 1054  
 Sodium fluorozirconates 1449  
 Sodium formate 2058, 2095, 2241  
 Sodium hexachloroplatinate(IV) 1297  
 Sodium hexacyanoferrate(II) 179  
 Sodium hexafluorosilicate 962  
 Sodium hexahydroxyantimonate 839  
 Sodium hexahydroxyplatinate(IV) 1302, 1313  
 Sodium hydride 1168, 2057, 2067  
 Sodium hydrogencarbonate 2120  
 Sodium hydrogensulfate 2132  
 Sodium hydrogensulfides 875, 2228  
 Sodium hydrogensulfite 2235  
 Sodium hydroxide 1072, 2058, 2094  
 Sodium hydroxoferrate 162  
 Sodium hypophosphite 1254  
 Sodium isopropyl xanthate 1366  
 Sodium metaarsenite 820  
 Sodium metaborate 2014, 2020  
 Sodium metavanadate 1484  
 Sodium molybdate 1369, 1376, 1382  
 Sodium monosulfide 2222, 2224, 2227  
 Sodium oxalate 1085  
 Sodium oxides 2058, 2067  
 Sodium pentaborate 2015  
 Sodium pentasulfide 2223  
 Sodium permanganate 1855  
 Sodium peroxide 411, 470, 2067  
 Sodium polysulfides 830, 1119, 2069, 2225  
 Sodium pyroantimonate 839  
 Sodium selenide 875  
 Sodium selenite 1562  
 Sodium selenosulfate 1562  
 Sodium silicate 2131  
 Sodium sulfate 2121  
   electrochemical decomposition 2129  
   solubility 2122  
 Sodium sulfhydrate 1371  
 Sodium sulfide 671, 875  
   leaching 830  
   solubility in water 2123  
 Sodium sulfite 830, 2235  
 Sodium sulfoxides 1119, 1121  
 Sodium tetraborate decahydrate 2012  
 Sodium tetraborate pentahydrate 2012  
 Sodium tetrasulfide 2223  
 Sodium tetrathioantimonate 840  
 Sodium thioantimonate 832  
 Sodium thiosulfate 830, 1187, 1218, 1258, 2236  
 Sodium zirconate 1462  
 Sodium zirconium silicate 1462  
 Sodium-potassium alloys 1166, 2069  
 Sodium-sulfur batteries 2069  
 Soft iron 146  
 Soft lignite 203  
 Soft magnetic steels 270  
 Softening 231  
 Softening of lead 607  
 Softening points of coal 232  
 Soil stabilization 1033, 2270, 2275  
 Solar cells 6, 875, 1539  
 Solar evaporation 987, 1007, 2153, 2154, 2167  
 Solar silicon 1879  
 Solder alloys 1538  
 Solder plating 1255  
 Soldering 1168  
 Solders 4, 6, 708, 875, 1207, 1308  
 Solidification 318  
 Solidification morphology of steel 318  
 Solidification of concrete 1109

Solid-state reactions of iron compounds 173  
 Solid-waste disposal 546  
 Solubility  
   of carbon in ferrosilicochromium 441  
   of carbon in molten iron alloys 290  
   of gases in molten copper 497  
   of hydrogen in pure iron 292  
   of kieserite 1030, 2165  
   of metals in mercury 909  
   of nitrogen in pure iron 292  
   of oxygen in cobalt 937  
   of oxygen in silver 1220  
   of potassium dicyanoaurate(I) in water 1200  
   of potassium sulfate 2191  
   of pyrogenic silica in caustic soda 1958  
   of silver compounds 1231  
     in water 1243  
   of SiO<sub>2</sub> in water 1913  
   of SO<sub>2</sub> in polyglycol 671  
   of sodium chloride 2075  
   of sodium sulfate 2122  
   of sodium sulfate in water 2123  
 Solution mining 1008, 2080, 2148  
 Solution Mining Research Institute 2086  
 Solution purification 657  
 Solvay process 2098, 2108, 2116, 2274  
 Solvent extraction 170, 657, 836, 1295, 1336, 1338, 1339, 1405, 1461, 1462, 1494, 1661, 1714  
   of dilute copper solutions 526  
   of indium 808  
 Sorel cement 1011, 1033  
 Sorelmetal 104  
 Special-quality steel 2  
 Specific heat capacity of iron 373  
 Specular hematite 33  
 Specularite 34, 35  
 Speiss 594, 1234  
 Spent liquors from potash industry 1005  
 Sperrylite 1276, 1277  
 Sphalerite 644, 928, 1524, 1532  
 Sphene 1134, 1136, 1172  
 Spherical autoclaves 695  
 Spheroidal graphite cast iron 341  
 Spheroidal pig iron 140  
 Spheroidal silver powder 1250  
 Spheroidal titanium powder 1167  
 Spheroidal ZnS 669  
 Spiegeleisen 1814  
 Spinels 1033  
 Spiral classifier 41  
 Splint coal 199  
 Spodumene 2032, 2036, 2039, 2049  
 Sponge iron 141, 283, 286  
 Sponge iron plants 44  
 Spontaneous combustion 217  
 Spontaneous decomposition of some complexes of plati-

num metals 1320  
 Sporinite 194  
 Spray condenser 651  
 Spray galvanizing 662  
 Spray towers 97  
 Spray-roast of metal chloride solutions 169  
 Sputtering targets 1346, 1374  
 Stabilizers for plastics 874  
 Stainless steel 310, 451, 772  
   corrosion 366  
   starting sheets 535  
   strip 273  
 Stannates(IV) 710  
 α-Stannic acid 711  
 β-Stannic acid 711  
 Stannite 686  
 Stannous hexafluorozirconate 1450  
 Stannum 683  
 Starch 1079  
 Starting a new furnace 59  
 Starting sheet cathodes 534  
 Stassfurtite 2145  
 Stationary calciners 1087, 1094  
 Steam power 281  
 Steel 1, 146  
   alloy 9, 385  
   blister 279  
   case hardening 370  
   chemically resistant 270  
   chromium-coated 359  
   constructional 1  
   consumption 389  
   crucible 279  
   cryogenic 270  
   enameling 944  
   high-temperature 369  
   ingot 280  
   ingot killed 327  
   killed 325  
   pretreatment of used products 386  
   production 388  
     environmental aspects 377  
     production methods 302  
   puddled 279  
   recycling 381  
   rimming 324  
   rolled 281  
   scrap 21  
   semikilled 327  
   shear 279  
   soft magnetic 270  
   solidification morphology 318  
   special-quality 2  
   sulfidation 370  
   tool 1  
   vacuum treatment 316  
   world trade 389

Steel pretreatment 941  
 Steel strip production 335  
 Steel wool cathode 1194  
 Steelmaking 52  
 Stellites 471, 924  
 Stephanite 1221  
 Sternbergite 1221  
 Stibine 840, 843  
 Stibiocolumbites 1405  
 Stibiopalladinite 1277  
 Stibnite 825, 826, 839  
 Stishovite 1904, 1905  
 Stokesite 686  
 Storage batteries 871  
 Storage caverns 2085  
 Stottite 1507  
 Stoves for heat recovery 100  
 Strand casting 328  
 Stress-corrosion cracking 364, 367  
 Stromeyerite 1221  
 Strontianite 2330  
 Strontium 13, 2329  
 Strontium carbonate 2331  
 Strontium chloride 2333  
 Strontium chromate 1806, 2333  
 Strontium in seawater 1017  
 Strontium nitrate 2331, 2332  
 Structure of ultramarine 1117  
 Struverite 1419  
 Studio radio tapes 186  
 Stupp 896, 900  
 Subbituminous coal 199, 203  
 Sublimation 1461  
 Submerged arc furnaces 417, 442  
 Submerged combustion 2293  
 Sugar refining 2275  
 Sulfadiazine silver(I) 1253  
 Sulfamic acid 613  
 Sulfate process 1140, 1141, 1147  
 Sulfated monoglyceride of coconut oil, see *Syntex VB*  
 Sulfation 745, 1229  
 Sulfation roasting 504, 931  
   of powdered copper matte 1232  
 Sulfatotitanates 1172  
 Sulfidation 761  
 Sulfidation of iron and steel 370  
 Sulfide precipitation 321, 770  
 Sulfidic copper-bismuth concentrates 848  
 Sulfigran process 2228  
 Sulfinic acids 915  
 Sulfites 165, 2234  
 Sulfomat process 2130  
 Sulfur  
   chromophores 1117

  dyes 2229  
   from hydrogen sulfide 1100  
   in coal 203, 205, 219  
   in coke 53  
   recovery 1100  
 Sulfur dioxide 998, 1057  
 Sulfur dioxide conversion to elemental sulfur 733  
 Sulfur tetrafluoride 911  
 Sulfur trioxide emission 133  
 Sulfuric acid pickling solutions 166  
 Sulfuric acid recycling 1149  
 Sulfur-sulfur bonds 2221  
 Sulmag II process 1019  
 Sumitomo process 128, 129, 935  
 Sundite 1221  
 Sunshine electrolytic antimony process 831  
 Superalloys 473, 1375, 1482, 1496  
 Super-purity aluminum 1055  
 Superquick-acting fuses 1257  
 Super-VHS video 186  
 Supplement for animal feeds 1024  
 Supported catalysts 1279, 1284  
 Surface coatings 351, 385  
 Surface hardening 1374  
 Surface properties of TiO<sub>2</sub> 1135  
 Surface silanol groups 1965  
 Surface siloxanes 1936  
 Surface-active additives 535  
 Swelling during reduction 50  
 Swelling of coal 226, 233  
 SX-Carbonate process 964, 969  
 Syenite 1070  
 Sylvinit 2162  
   flotation 2178  
   ores 2174, 2178  
   precipitation 2169  
 Sylvite 2145, 2159, 2179, 2212  
 Sympathetic inks 941  
 Synergistic effects 1719  
 Syngenite 2145, 2196, 2286, 2310  
 Syntex VB 1366  
 Synthetic  
   carnallite 1006  
   Fe<sub>3</sub>O<sub>4</sub> 162  
   flocculant 1079  
   iron oxide pigments 172  
   kieserite 1009  
   manganese dioxides 1839  
   rutile 1136, 1139  
   sapphire 1101  
   scheelite 462, 2313  
   ultramarines 1116  
   zeolites 1096, 1110  
 Synthol process 213  
 System Ag-Pb-Zn 608

System  $Al_2(SO_4)_3-Al(OH)_3-H_2O$  1103  
 System  $Al_2(SO_4)_3-H_2O$  1103  
 System  $Al_2O_3-CaO-SiO_2$  1916  
 System  $Al_2O_3-Fe_2O_3-H_2O$  1065  
 System  $Al_2O_3-H_2O$  1065  
 System Au-Ag-Cu 1202  
 System  $B_2O_3-H_2O$  2007  
 System CaO-FeO-SiO<sub>2</sub> 295, 594  
 System  $CaSO_4-H_2O$  2282  
 System C-Cr-Fe 439  
 System Cu-Cu<sub>2</sub>O 530  
 System Cu-Cu<sub>2</sub>S 518  
 System Fe-B 465  
 System Fe-C 144, 290  
 System Fe-C-Cr-O 310  
 System Fe-Cr 440  
 System Fe-HCl-H<sub>2</sub> 694  
 System Fe-Mo 477  
 System Fe-O 291  
 System Fe-O-C 690  
 System FeO-Fe<sub>2</sub>O<sub>3</sub>-SiO<sub>2</sub> 506  
 System FeO-MgO-SiO<sub>2</sub> 455  
 System Fe-Si 416  
 System Fe-Sn 700  
 System Fe-V 476  
 System Fe-W 461  
 System  $H_2O-NaHCO_3-Na_2CO_3$  2120  
 System  $K_2Cl_2-MgCl_2-Na_2Cl_2-H_2$  2168  
 System  $K_2-Mg-Cl_2-SO_4^{2-}-H_2O$  2193  
 System KCl-H<sub>2</sub>O 2160  
 System KCl-MgCl<sub>2</sub>-H<sub>2</sub>O 2167  
 System  $MgCl_2 \cdot nH_2O$  1005  
 System MgO-CaO-SiO<sub>2</sub>-Fe<sub>2</sub>O<sub>3</sub> 1027  
 System Mn-C 1821  
 System Mn-O 1819  
 System  $Na_2CO_3-H_2O$  2105  
 System  $Na_2O-Al_2O_3-H_2O$  1074  
 System  $Na_2S-S$  2221, 2226  
 System  $Na_3AlF_6-Al_2O_3-CaF_2$  1048  
 System  $Na_3AlF_6-AlF_3-Al_2O_3$  1047  
 System  $Na_3AlF_6-Li_3AlF_6-Al_2O_3$  1048  
 System NaCl-H<sub>2</sub>O 2075  
 System Na-K 2157  
 System NaOH-H<sub>2</sub>O 2095  
 System Pb-Bi-Ca-Mg 851  
 System Pb-Cu-S 605  
 System Pb-S-O 586  
 System Sn-HCl-H<sub>2</sub> 694  
 System Sn-O-C 690  
 System Ti-Fe 473  
 System Ti-S 1169  
 System  $UO_2(NO_3)_2-HNO_3-H_2O$  1643  
 System  $UO_2SO_4-H_2SO_4-H_2O$  1643  
 System Zn-Fe-S-O 646

Syton 1947

Szaibelyite 1987, 2010  
 Szechtman process 2066

## T

Tabular aluminas 1101  
 Tachhydrite 2145, 2311  
 Taconite 33, 35  
 Tafel equation 658  
 Tafel reaction 364, 367  
 Talc 1003, 1015  
 Tanning agents 1783  
 Tanning of leather 9, 1116  
 Tantalates 1424  
 Tantalite 33, 1404, 1419  
 Tantalocolumbite 1404  
 Tantalum 9, 1417  
   applications 1426  
   capacitors 1422  
   implants 1423  
   powder 1421  
   processing routes 1419  
   scrap 1420  
 Tantalum alkoxides 1425  
 Tantalum carbide 1421, 1425  
 Tantalum nitride 1425  
 Tantalum oxides 1423  
 Tantalum pentachloride 1425  
 Tantalum pentafluoride 1424  
 Tantalum silicide 1425  
 Tantalum-boron system 1425  
 Tantalum-containing tin slags 1418  
 Tantalum-Niobium International Study Center 19  
 Tapiolite 1419  
 Tapping a molten material from the furnace 58  
 Tar 202, 242, 243, 244  
 Tarnishing of silver 1252  
 Taunusquarzit 1912  
 Teallite 686  
 Technetium 1587, 1589  
 Technical varieties of iron 146  
 Telluric iron 31, 274  
 Tellurides 1577  
 Tellurium 10, 18, 1230, 1571  
 Tellurium dioxide 1576  
 Tellurium halides 1576  
 Tellurium hexafluoride 1579  
 Tellurium-lead 1577  
 Tellurous acid 1577  
 Tennantite 498, 797  
 Tenorite 498  
 Terbium 12  
 Terephthalic acid from benzoic acid 2204  
 Ternary molybdenum chalcogenides 1381

*Terra tripolitana* 1925  
 Tertiary amines 1718  
 Tetraborane 2000  
 Tetrabromosilane 1893  
 Tetrachloroaurate(III) complex 1187  
 Tetrachloroauric acid 1196, 1200, 1201, 1211  
 Tetrachloroferrates 151  
 Tetrachloropalladate(II) 1303  
 Tetrachloropalladic(II) acid 1303  
 Tetrachlorosilane 1887, 1889  
 Tetraedrite 498  
 Tetraethyllead 633, 1000, 2068  
 Tetrahydrite 825, 830  
 Tetramethyltin 1499  
 Tetramminepalladium(II) chloride 1303  
 Tetrapentoxysilane 1944  
 Textile auxiliaries 215  
 Textile finishes 840  
 Textile technology 1308  
 Thallium 10, 1543  
 Thallium(I) carbonate 1551  
 Thallium(I) chloride 1549  
 Thallium(I) fluoride 1550  
 Thallium(I) hydroxide 1549  
 Thallium(I) iodide 1550  
 Thallium metasilicate 1551  
 Thallium(I) nitrate 1551  
 Thallium(I) oxide 1548  
 Thallium(III) oxide 1549  
 Thallium(I) sulfate 1550  
 Thallium(I) sulfide 1550  
 Thaumassite 2286  
 Thenard's blue 944  
 Thenardite 2122, 2145, 2162  
 1-(2-Thenoyl-3,3,3-trifluoroacetone) 1680  
 Thermal conductivity of pure iron 375  
 Thermal decomposition  
   of aluminum hydroxide 1066, 1099  
   of dicyanoaurate(I) complex 1198  
   of Fe(CO)<sub>5</sub> 177  
   of ferrous oxalate 147  
   of platinum group metal complexes 1299  
   of silver carbonate 1250  
   of silver(I) oxide 1250  
   of the ammonium chloro complexes 1298  
   of ThI<sub>4</sub> 1670  
   of titanium halides 1164  
 Thermal dissociation of ThI<sub>4</sub> 1669  
 Thermal dissociation of zircon 1435, 1462  
 Thermal expansion of refractory silica 1916  
 Thermal ore beneficiation 691  
 Thermal properties of copper 495  
 Thermionic converters 1346  
 Thermistors 948  
 Thermite reaction 1043

Thermocouple elements 1346  
 Thermonantrite 2106  
 Thermonuclear reactions 2042  
 Thermoplasticity of coal 224, 227, 231  
 Thickener 1079  
 Thin-film technology 1313, 1314  
 Thioarsenites 797  
*Thiobacillus ferrooxidans* 526, 695  
*Thiobacillus thiooxidans* 526  
 Thiocyanate ion 149  
 Thiogermanates 1517  
 Thiomolybdate 1339  
 Thionalide 1305  
 Thiophenes 205  
 Thiosulfate leaching 1218, 1225  
 Thiosulfate silver complexes 1247  
 Thiosulfates 164, 2236  
 Thiosulfates in waste solutions 165  
 Thiourea 1254, 1305  
 Thomas converter 303  
 Thomas slag 280  
 Thomas-Gilchrist process 31  
 Thoreaulite 686  
 Thorianite 1655  
 Thorite 1655  
 Thorium 10, 11, 1649, 1745  
   decay chain 1650  
 Thorium borides 1668  
 Thorium carbides 1668  
 Thorium carbonate 1668  
 Thorium halides 1665  
 Thorium hydrides 1653, 1668  
 Thorium hydroxide 1668  
 Thorium nitrate 1668  
 Thorium nitrides 1654, 1668  
 Thorium oxides 1663  
 Thorium peroxide 1668  
 Thorium phosphide 1668  
 Thorium sulfate 1668  
 Thorium sulfides 1668  
 Thorogummite 1655  
 Thoron 10  
 Thucholite 1607  
 Thulium 12  
 Thyristors 1346  
 Tiemannite 1559  
 Tin 5, 683  
   cans 21  
   electrorefining 704  
   from its ores 691  
   from scrap 705  
   refining 702  
   slags 1418  
   utensils 708



- vapor 684
- Tin alkyl compounds 712
- Tin amalgam 909
- Tin aryl compounds 712
- Tin(II) bromide 710
- Tin(IV) bromide 710
- Tin chloride 699
- Tin(II) chloride 709, 1254
- Tin(II) compounds 709
- Tin(IV) compounds 710
- Tin(II) cyanide 710
- Tin dichloride 704
- Tin disulfide 711
- Tin(II) fluoroborate 710
- Tin(IV) halides 710
- Tin(IV) hydride 710
- Tin(II) iodide 710
- Tin(II) oxide 710  
hydrate 710
- Tin(IV) oxide 710  
hydrate 710
- Tin(II) salt of ethylhexanoic acid 710
- Tin(IV) sulfide 711
- Tin tetrachloride 704
- Tincal 1987
- Tincalconite 1987
- Tin-containing alloys 706
- Tin-iron alloy 700
- Tinplate 4, 359, 705
- Tinplate packaging 386
- Titanates 1155
- $\beta$ -Titanic acid 1172
- Titanic acid 1173
- Titanite 1134, 1136, 1172
- Titanium 7, 1000, 1129
- alums 1106, 1171
- anodes 527
- blanks 534
- electrowinning 1165
- in cast iron 474
- in tool steels 474
- master alloys 475
- pickling 1168
- scrap 475, 1165, 1166
- slag 104, 474, 1139, 1160
- sponge 476, 1161, 1166, 1167
- welding 1168
- Titanium borides 1173
- Titanium bromides 1170
- Titanium carbide 1165, 1173
- Titanium carbides 1170
- Titanium carbonitride 1173
- Titanium(II) chloride 1165
- Titanium(III) chloride 1170
- Titanium chlorides 1165, 1170
- Titanium(II) compounds 1170
- Titanium(III) compounds 1170
- Titanium(IV) compounds 1171
- Titanium cyanonitride 1173
- Titanium dicyanide 1173
- Titanium dioxide 149, 1134, 1165
- Titanium dioxide chlorination 1160
- Titanium dioxide pigments 1113
- Titanium dioxide reduction 1162
- Titanium disulfide 1173
- Titanium double sulfates 1171
- Titanium fluoride 1171
- Titanium fluorides 1170
- Titanium grades 1131
- Titanium(III) hydroxide 1171
- Titanium iodides 1164, 1170
- Titanium monoxide 1165
- Titanium nitride 1133, 1165, 1171
- Titanium nitrides 1170
- Titanium oxide hydrate 1142
- Titanium(III) oxide 1171
- Titanium oxides 1170
- Titanium phosphides 1170
- Titanium sulfate hydrolysis 1142
- Titanium sulfides 1170, 1173
- Titanium tetrabromide 1172
- Titanium tetrachloride 1160, 1165, 1171
- Titanium tetrafluoride 1165
- Titanium tetrafluoride reduction 1164
- Titanohematites 1134
- Titanomagnetite 1134, 1136, 1139, 1473, 1476  
deposits 1475  
ores 1472
- Titanyl sulfate 1172
- Ttjamunite 1606
- Todorokite 1830
- Toner in photocopiers 158
- Toning blue 179
- Tool steels 1, 461, 1345
- Toothpaste 1096
- Top-blown oxygen converter 303
- Top-blown rotary converter 519, 520, 754, 1235
- Tops and bottoms process 1282
- Torbernite 1606
- TORCO process 503
- Torpedo ladies 102
- Toscoal process 251
- Total roasting 504
- Tough-pitch copper 530, 539
- Tourmaline 687
- Toxicity of chromium 453
- Toxicity of mercury 917
- Trade in steel 389
- Transformation of  $\beta$ -tin 684
- Transforming coal into secondary fuels 210
- Transistors 1346
- Transmutation of base metals 1185
- Transparent  $\alpha$ -FeO(OH) 190
- Transparent brown iron oxides 191
- Transparent cobalt blue 950
- Transparent cobalt green 950
- Transparent iron blue 191
- Transparent iron oxides 177, 190
- Transparent red iron oxide 190
- Transparent titanium dioxide 1159
- Transparent yellow iron oxide 190
- Transparent zinc oxide 677
- Transuranium metals 10
- Traveling grate 45
- Treatment of nickeliferous pyrrhotite 745
- Treatment of potash ores 2149
- Tribasic Copper Sulfate 572
- Tribasic copper sulfate 572
- Tribology 1169
- Tributyl phosphate 170, 748, 1296, 1615  
extraction 1438
- Tributyltin chloride 712
- Tricalcium silicate 1015
- Tricapryl monomethyl ammonium chloride, *see Aliquat*
- Tricarbonatodioxouranate 1643
- Trichlorogermane 1518
- Trichlorooxomolybdenum(V) 1382
- Trichlorosilane 1866, 1878, 1886, 1888  
hydrolysis 1897  
oxidation 1897  
pyrolysis 1889
- Trichlorosilanol 1897
- Tridymite 1902-1904, 1909, 1910, 1916
- Triethyl indium 1538
- Triethylamine 2202
- Triethylphosphine gold complex of thioglucose  
tetraacetate 1202
- Trigermane 1516
- Triisooctylamine 934
- Trimercapto-s-triazine 905
- Trimethyl borate 2067
- Trimethyl indium 1538
- Trimethylbismuth 863
- Tri-*n*-butyl phosphate 1715
- Trinuclear iron carbonyl 154
- Trioctylamine 1296, 1339
- Triphenyl bismuth 863
- Triphenyl indium 1538
- Triphylene 2033, 2036
- Tripoli 1911, 1912, 1918
- Tripolite 1925
- Tri-*sec*-amylborane 2159
- Tri-*sec*-butylborane 2159
- Tritium 2042
- Triuranium octaoxide 1641
- Trona 2059, 2098, 2106, 2114, 2120
- Troostite 645
- Tscheffikinite 1655
- Titanium slag 1136
- Tube digester 1076
- Tula process 306
- Tumble test 49
- Tung sten* 1330
- Tungstates 1351
- Tungsten 9, 1329, 1376  
alloys 1345  
bronzes 1352  
in catalysis 1353  
recycling 1355  
scrap 1335
- Tungsten carbide 9, 936
- Tungsten dioxide 1350
- Tungsten hexacarbonyl 1349
- Tungsten hexachloride 1352
- Tungsten hexafluoride 1357
- Tungsten oxide 464
- Tungsten oxytetrachloride 1353
- Tungsten trioxide 1350  
reduction 1340
- Tungsten-arsenic compounds 1350
- Tungsten-boron compounds 1349
- Tungsten-bromine compounds 1353
- Tungsten-carbon compounds 1349
- Tungsten-chlorine compounds 1352
- Tungsten-containing tin concentrates 695
- Tungsten-fluorine compounds 1352
- Tungsten-iodine compounds 1353
- Tungstenite 1333
- Tungsten-nitrogen compounds 1349
- Tungsten-oxygen compounds 1350
- Tungsten-phosphorus compounds 1350
- Tungsten-rhenium alloys 10, 1496
- Tungsten-rhenium system 1495
- Tungsten-selenium compounds 1352
- Tungsten-silicon compounds 1349
- Tungsten-sulfur compounds 1352
- Tungsten-tellurium compounds 1352
- Tungstic acids 1351
- Tungstite 1333
- Turbine blades 1346
- Turnbull's blue 148, 149, 179
- Type metal 6
- Tyuyamunite 1472, 1475
- U**
- Ugine ferronickel process 457
- Ulexite 1987, 2014, 2016

Ultimate analysis of coal 202, 218  
 Ultracentrifuges 1629  
 Ultra-high-purity niobium 1412  
 Ultramarine pigments 1116  
 Ultramarine structure 1117  
 Ultramarines as zeolites 1118  
 Umbers 172  
 Uncontrolled criticality 1644  
 Updraft sintering 587  
 Uraninite 1606  
 Uranium 10, 11, 1000, 1599  
 from phosphate rock 23  
 powder 1637  
 Uranium carbides 1639  
 Uranium dioxide 1620  
 Uranium fluoride 1000  
 Uranium halides 1637  
 Uranium hexafluoride 1620, 1623  
 Uranium hydride 1637  
 Uranium nitrates 1642  
 Uranium nitrides 1640  
 Uranium oxides 1640  
 Uranium peroxides 1642  
 Uranium sulfates 1643  
 Uranium tetrafluoride 1620  
 Uranium trioxide 1620  
 Uranium-vanadium ores 1472, 1473  
 Uranophane 1606  
 Uranothorianite 1655  
 Uranothorite 1606, 1655  
 Uranyl nitrate 1620  
 Uses  
 of aluminothermic processes 415  
 of cobalt compounds 941  
 of copper 542

**V**

Vacuum arc decarburization 312  
 Vacuum arc furnaces 1166, 1373  
 Vacuum arc remelting 338  
 Vacuum cooling crystallizer 2125  
 Vacuum crystallization 166  
 Vacuum dezincing 854  
 Vacuum distillation 806, 857, 1163, 1461  
 Vacuum treatment of steel 316  
 Vacuum vapor deposition 359  
 Vacuum vaporization of silver 1255  
 Vacuum volatilization of SnO 701  
 Valentinite 825  
 VAMI cell 991  
 Van Arkel-de Boer process 1461, 1464  
 Vanadates 1483  
 Vanadinite 584, 1472  
 Vanadium 9, 1069

alum 1106  
 compounds 1370  
 from fuel oil 23  
 slags 1473, 1476  
 Vanadium carbides 1484  
 Vanadium halides 1484  
 Vanadium hydrides 1485  
 Vanadium nitrides 1484  
 Vanadium oxides 1483  
 Vanadium oxychloride 1141  
 Vanadium oxychloride removal 1145  
 Vanadium oxytrichloride 1484  
 Vanadium pentoxide 1477, 1479  
 Vanadium silicides 1485  
 Vanadium suboxides 1483  
 Vanadium tetrachloride 1141, 1484  
 Vanadium tetrachloride removal 1145  
 Vanadium trichloride 1484  
 Vanadium-aluminum alloys 1481  
 Vanadium-containing titanium alloys 1482  
 Vanadium-gallium alloys 1483  
 Vanadyl oxalate 1484  
 Vanadyl sulfate 1484  
 Vanthoffite 2122, 2145  
 Vapor deposition of gold 1208  
 Vapor pressure  
 of mercury 892  
 of MgCl<sub>2</sub> solutions 1006  
 of SnS 691  
 Vaporization of SnS 692  
 Varlamoffite 686  
 Varnish industries 1110  
 Varnishes 215  
 Vat leaching 526  
 Vauquelin's salt 1303  
 Venturi scrubbers 98  
 Vermiculite 342  
 Vernadite 1830  
 Versatic 10 1718  
 Versatic 911 1718  
 Vertical retorts 649  
 Videocassettes 185  
 Violarite 719  
 Violet ultramarine 1120  
 Viscose manufacture 666  
 Viscosity of mercury 892  
 Vitamins 215  
 Vitigran, Conc. 572  
 Vitraints 237  
 Vitreous silica 1922, 1924  
 Vitrinite 193, 205, 227  
 Vitroplast 234  
 Vivianite 34  
 Volatile matter 202, 218

Volatile organotin compounds 712  
 Volatile products in coal pyrolysis 240  
 Volatilization of tin from concentrates 694  
 Volmer-Butler equation 364  
 Voltage in Al cell 1051  
 Vossen-Blue 191  
 Vrbaita 1544  
 Vulcanization activator 663  
 Vulcanized rubber 676

**W**

Wacker-Kupferkalk 572  
 Waelz process 595, 645, 647, 657, 660, 871  
 Wafer manufacture 1876  
 Wagner-Hauffe doping effect 369  
 Wallisite 1544  
 Warren Spring process 694  
 Waste gas problems 1150  
 Waste management 132, 137  
 Waste sulfuric acid 2126  
 Water consumption in a steel plant 379  
 Water glass, see *Sodium silicate*  
 Water pollution control 132  
 Water protection 545  
 Water purification 1096, 1098, 1099, 1105  
 Water treatment 7, 152, 666, 1109, 2274  
 Wave filters 1409  
 Waveguides 1424  
 Wavellite 1085  
 Weak acid problem 1147  
 Weak acid recovery 1148  
 Welding 668  
 Welding electrodes 1346  
 Welding of titanium 1168  
 Weloganite 1434  
 Whisker formation 50  
 White alloy 930  
 White antimony 838  
 White arsenic 795  
 White cast iron 1, 342  
 White copper 716  
 White gold alloys 1205  
 White metal 518  
 Wiberg-Söderfors process 110  
 Wickenol 1116  
 Widmanstätten structure 31, 274  
 Wiedemann-Franz-Lorenz law 375  
 Willemite 645, 660  
 Williamson ether synthesis 2068  
 Willow blue 944  
 Winkler gasifiers 214  
 Wisser's model of coal structure 224  
 Wismut 845

Wittig reaction 2068  
 Wodginita 1419  
 Wöhler's reduction of AlCl<sub>3</sub> by Na 406  
 Wohlwill electrolytic refining 1196  
 Wolfram, see *Tungsten*  
 Wolframite 33, 462, 1329, 1334, 1336  
 Wollastonite 1916  
 Wood charcoal 31  
 Wood industry 1772  
 Wood preservatives 149, 666, 817  
 Wood's alloy 875  
 WORCRA process 523  
 World market for scrap 387  
 Wrought iron 1  
 Wulfenite 1363  
 Wullenite 584  
 Wurtz synthesis 2059, 2068  
 Wurtzite structure 671, 884  
 Wurzite 644  
 Wustite 166

**X**

Xanthates 1254  
 Xanthine oxidase 1376  
 Xenon short arc lamps 1346  
 Xenotime 1697, 1708, 1724  
 Xerography 1564  
 X-ray anodes 1374  
 X-ray films 1223  
 X-ray screens 12  
 X-ray tubes 9  
 Xylolith 1024

**Y**

Yellow  $\alpha$ -FeOOH 175  
 Yellow antimony 823  
 Yellow cake 1612, 1616  
 Yellow iron oxide production 174  
 Yellow mercury(II) iodide 913  
 Ytterbium 12  
 Ytterbium earths 1695  
 Yttrium earths 1698  
 Yttrium orthoaluminate 1734  
 Yttrium oxide separation 1722  
 Yttrium tantalate 1424  
 Yttrotantalite 1419

**Z**

Zadra process 1193  
 Zaffre 924  
 Zementquarzit 1912  
 Zeolite structure 1075  
 Zeolites 2213

- Ziegler process 1097, 1099  
 Ziegler-Natta catalysts 1466  
 Ziervogel process 1218, 1231, 1232  
 Zinc 5, 18, 641  
   by retort process 649  
   coating 355  
   coating on steel 661  
   dross 670  
   dust 657, 662, 663, 679  
   electrowinning 653  
   fumes 668  
   hydrometallurgy 652  
   production in shaft furnace 650  
   recovery rotary kilns 594  
   refining 652  
   soaps 665  
   spray condenser 649  
 Zinc antimonide 837  
 Zinc blende 644  
 Zinc borates 2018  
 Zinc bromide 665  
 Zinc bromide batteries 665  
 Zinc carbonate 663  
 Zinc chloride 664, 667  
 Zinc chromate 667, 668, 1791, 1806  
 Zinc cyanamide 667, 678  
 Zinc cyanide 665  
 Zinc ferrite 653  
 Zinc ferrite pigment 679  
 Zinc fluoride 663  
 Zinc hydroxide 663  
 Zinc hydroxyphosphite 678  
 Zinc iodide 665  
 Zinc oxide 662, 673  
 Zinc oxide fume 668  
 Zinc oxide in the rubber industry 676  
 Zinc phosphate 144, 677  
 Zinc phosphides 667, 668  
 Zinc potassium chromate 1806  
 Zinc protoporphyrin 626  
 Zinc pyrithione 666  
 Zinc stearate 662  
 Zinc sulfate 666  
 Zinc sulfide 10, 24, 673  
   by hydrothermal process 671  
 Zinc sulfide pigments 667, 668  
 Zinc tetraoxycromate 1806  
 Zinc thiocarbonate 662  
 Zinc vapor deposition 358  
 Zinc white 673  
 Zincates 674  
 Zinc-based chemicals 662  
 Zincite 645  
 Zinc-manganese dioxide batteries 898  
 Zinc-mercury(II) oxide batteries 898  
 Zinkchromat 1806  
 Zinktetraoxichromat 1806  
 Zinnwaldite 2030, 2033  
 Zircaloy 1432, 1677  
 Zircon 101, 405, 1138, 1434, 1444, 1445, 1460, 1656  
   carbiding 1437  
   carbochlorination 1435  
   fluorosilicate fusion 1436  
   lime fusion 1437  
   thermal dissociation 1435, 1462  
 Zircon sand 10  
 Zirconia ceramics 1446  
 Zirconium 1000  
   clusters 1449  
   electrorefining 1440  
   electrowinning 1440  
   fires 1442  
   foil 1444  
   powder 1442  
   separation 1462  
   sponge 1441  
 Zirconium alkoxides 1453  
 Zirconium basic carbonate 1450  
 Zirconium basic sulfates 1450  
 Zirconium borides 1452  
 Zirconium carbide 1447, 1451  
 Zirconium carbonate 1450  
 Zirconium carbonitride 1437  
 Zirconium dioxide 1434  
 Zirconium hexafluorogermanate 1450  
 Zirconium hydride 1450, 1455  
 Zirconium hydroxide carboxylates 1453  
 Zirconium hydroxide chloride 1448, 1450  
 Zirconium monobromide hydride 1449  
 Zirconium nitrate 1455  
 Zirconium nitride 1451  
 Zirconium orthosilicates 1434  
 Zirconium oxide 1440, 1446  
 Zirconium phosphate 1452  
 Zirconium silicate 1445  
 Zirconium sulfates 1450, 1455  
 Zirconium tetrabromide 1449  
 Zirconium tetrachloride 1447, 1455, 1463  
 Zirconium tetrafluoride 1449  
 Zirconium tetraiodide 1449  
 Zirconium tetranitrate 1453  
 Zirconium tungstate 1452  
 Zirconolite 1434  
 Zirconsilicates 1434  
 Zone melting 836, 837, 857, 966, 1547, 2156